

THE NEW GENERATION LORAWAN SENSORS OF SENSECAP

How to Configure the RS485 Sensor for S2100 Data Logger

Version: v1.0.0



Table of Contents



1. Preparation	2
1.1 Sensor Probe.....	2
1.1.1 Tools	2
2. Connect the Sensor Probe	3
2.1 Disassemble the Data Logger.....	3
2.1.2 Power supply options of sensor.....	4
3. Setup the S2100	7
3.1 Connect to Sensor to App.....	7
3.2 Configure basic parameters through App.....	9
3.2.1 Select the Platform and Frequency	9
3.2.2 Set the Interval.....	9
3.2.3 Set the Packet Policy.....	10
3.2.4 Restore Factory Setting	10
3.3 Configure RS485 Modbus-RTU Sensor via App	11
4. Check data on the SenseCAP Portal.....	14
4.1 Bind Sensor to SenseCAP Portal.....	14
4.2 Check Data on SenseCAP Portal.....	15
5. Support	17
5.1 Document Version	17



1. Preparation

1.1 Sensor Probe

Get these items ready:

Picture	Type	Quantity
	Data Logger	1
	pH sensor	1

pH sensor description:

<https://www.seeedstudio.com/RS485-pH-Sensor-S-pH-01A-p-4632.html>

1.1.1 Tools

Type	Description
Cross screwdriver	Cross recess No.2



2. Connect the Sensor Probe

2.1 Disassemble the Data Logger

1. Unscrew three screws.

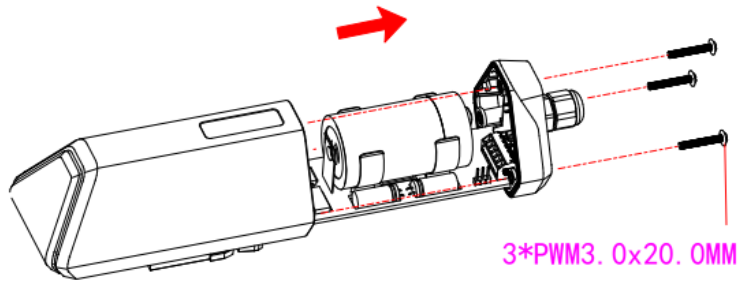

2. Take down the cover.

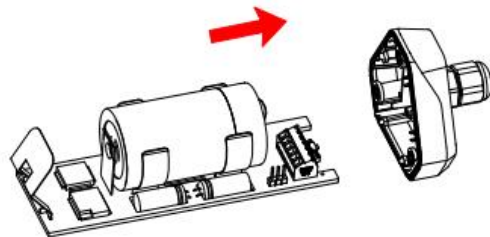

3. Remove the thread cap and pass it through the cable of the sensor, pass it through the bottom cover, and connect it to the wiring terminal.

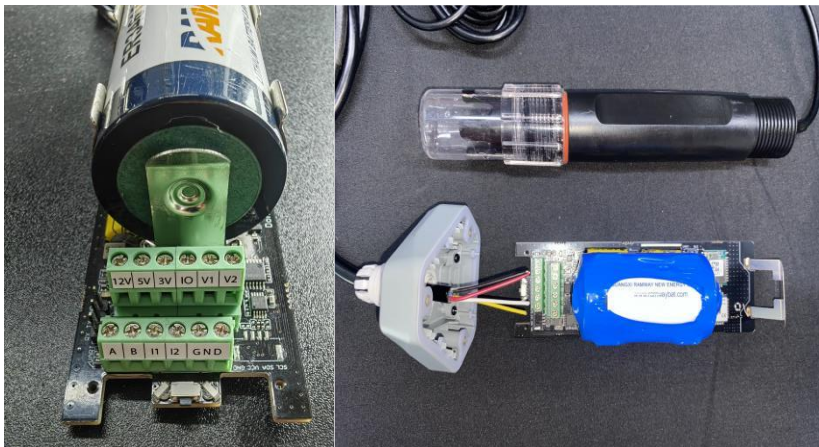



No.	Pin	Description
1	12V	External 12V input voltage. The Data Logger can be powered by an external 12V DC power supply. When using 12V power supply, the battery will serve as backup power supply.
2	5V	5V output voltage, providing 5V voltage to the sensor.
3	3V	3V output voltage, providing 3V voltage to the sensor.
4	IO	Acquisition level or pulse input
5	V1	The voltage input of 0 to 10V is collected
6	V2	The voltage input of 0 to 10V is collected
7	A	RS485 A/+
8	B	RS485 B/-
9	I1	Collect the current input from 4 to 20mA
10	I2	Collect the current input from 4 to 20mA
11	GND	Ground pin
12	GND	Ground pin

2.2 Power supply options of sensor

Data Logger supports two power supply modes, we choose the Built-in Battery mode:

Mode	Description
Built-in Battery	The Data Logger and sensors are powered by batteries. In this case, the Data Logger can be connected to a 5V sensor.



2.3 Connect the Sensor Probe

Wire sequence of pH sensor:

Wire Type	
Red Wire	5V
Black Wire	GND (11 or 12 pin would be OK)
Yellow Wire	RS485 A
White Wire	PS485 B

1. Pass the pH sensor cable through the bottom cover and connect it to the base of the Data Logger according to the wire sequence requirements;

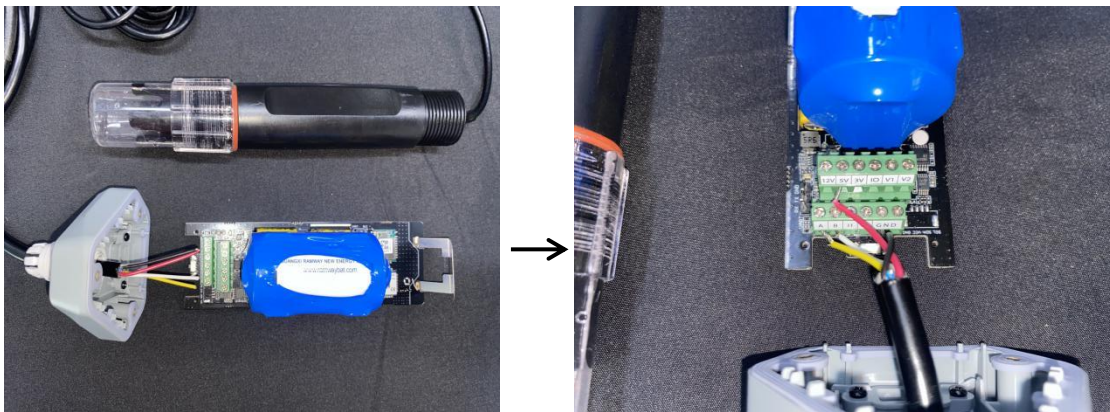

2. Connect the upper cover, rubber ring and screw cap in sequence





3. **Tighten the screws and screw caps to check the waterproofing.** If the wire diameter is too thin, add waterproof tape for winding.

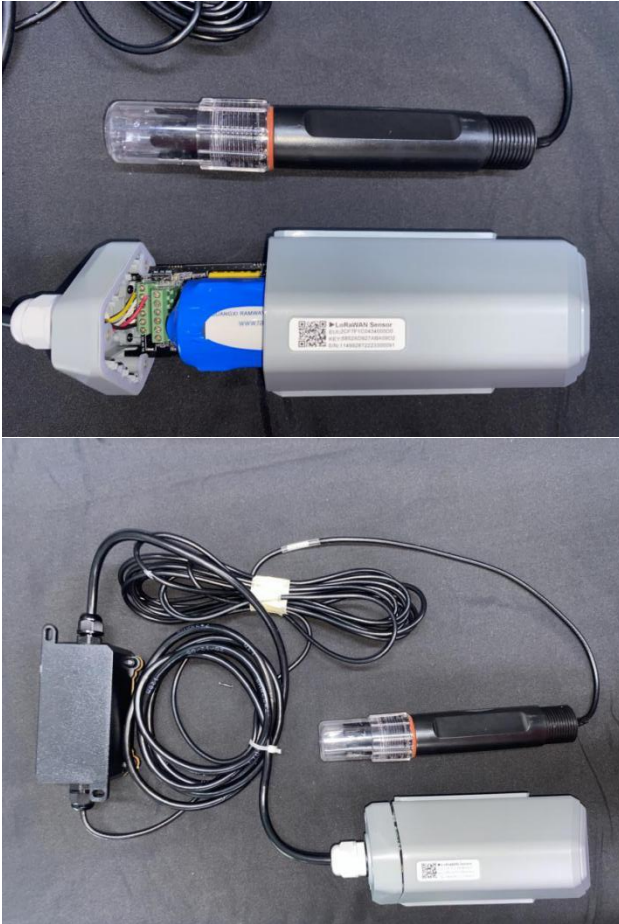

***Note:** When assembling the device, it is necessary to install the waterproof pad of the Data Logger and the adapter box, and tighten the screw cap and screw, otherwise the waterproof effect of the device may be affected!

If the wire diameter is too small, it can be wrapped with waterproof tape, as shown below:





3. Setup the S2100

3.1 Connect to Sensor to App

- 1) Press button and hold for **3 seconds**, the LED will flash at 1s frequency. Please use the App to connect the sensor within 1 minute; otherwise, the device will power off or reboot.

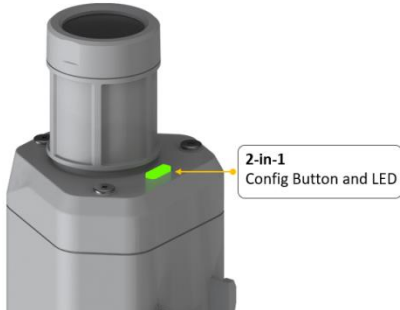

- 2) Please select “S2100 Data Logger”.

Please click the “Setup” button to turn on Bluetooth and click “Scan” to start scanning the sensor's Bluetooth.

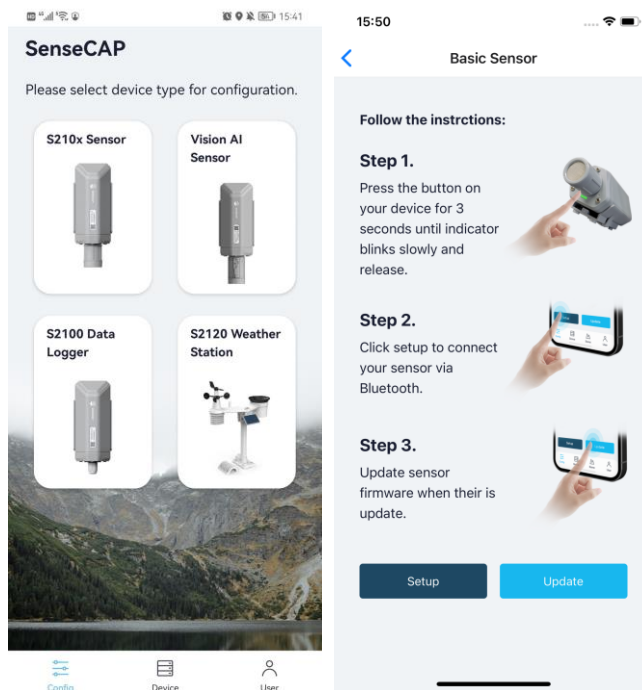

- 3) Select the Sensor by S/N (S/N is on the front label of the sensor). Then, the basic information of the sensor will be displayed after entering.

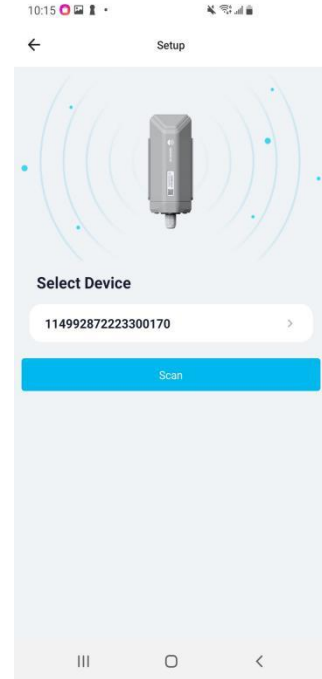
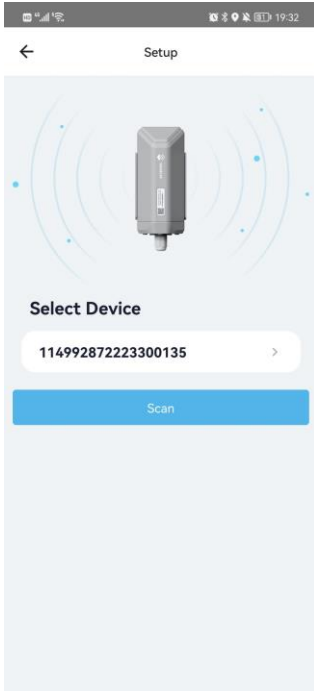

- 4) Enter configuration mode after Bluetooth connection is successful: LED flashes at 2s frequency.



3.2 Configure basic parameters through App

3.2.1 Select the Platform and Frequency

S210x Sensors are manufactured to support universal frequency plan from 863MHz ~928MHz in one SKU. That is to say, every single device can support 7 frequency plans.

Here we select the “SenseCAP for Helium” or “SenseCAP for TTN”. The Frequency Plan based on your actual situation.

***Note:** Data Logger can upload data when there is a Helium network around the user. It runs on SenseCAP private Helium Console. Users do not need to create a device on the Helium Console;

SenseCAP for TTN platform needs to be used with SenseCAP LoRaWAN outdoor gateway(<https://www.seeedstudio.com/LoRaWAN-Gateway-EU868-p-4305.html>)

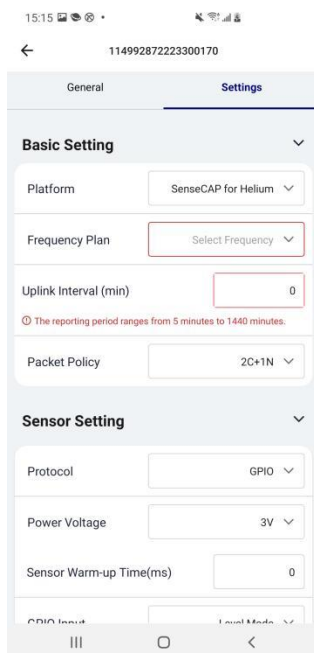

3.2.2 Set the Interval

The working mode of device: wake up the device every interval and collect measurement values and upload them through LoRa.

For example, the device collects and uploads data **every 60 minutes by default**.

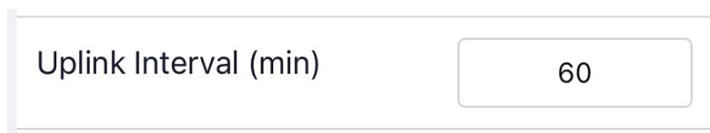



3.2.3 Set the Packet Policy

The sensor uplink packet strategy has three modes, we select 1N here or you can according to your own requirement.

Parameter	Description
2C+1N (default)	2C+1N (2 confirm packets and 1 none-confirm) is the best strategy, the mode can minimize the packet loss rate, however the device will consume the most data packet in TTN, or date credits in Helium network.
1C	1C (1 confirm) the device will sleep after get 1 received confirm packet from server.
1N	1N (1 none-confirm) the device only send packet and then start to sleep, no matter the server received the data or not.

3.2.4 Restore Factory Setting

When selecting the SenseCAP platform, you must use the fixed EUI/App EUI/App Key. Therefore, you need to restore the factory Settings before switching back to the SenseCAP platform from other platforms.

When we make a mistake or want to reset everything, we can click the button. The device will be restored to the factory's default configuration.

***Note:** The “Restore Factory” function can only reset the Basic Setting.



3.3 Configure RS485 Modbus-RTU Sensor via App

Select the “Protocol” as “RS485 Modbus RTU”. Then set the following parameters in turn.

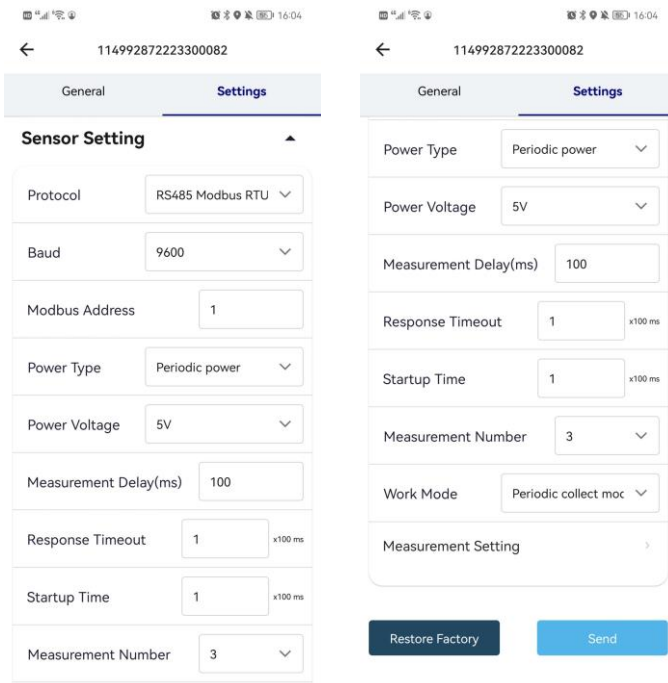

Baud Rate	Baud rate of communication with the sensor. Select 9600 here.
Modbus Address	Slave address of the sensor. The range is 1 to 247. Enter 1 here.
Power Type	Periodic power: Power the sensor before data collection, and power off the sensor after data collection. This mode reduces power consumption and increases battery life. Select periodic power .
Power Voltage	Select the supply 5V voltage to the sensor.
Sensor Warm-up Time	The warm-up time denotes the amount of time it takes for the sensor to attain its highest accuracy or performance level once the voltage supply has been applied. Enter 100ms generally.
Response Timeout	After Data Logger initiates a data read request to the sensor, it waits for the timeout time for a response. If this time is exceeded, the command will be resent; 5*(100ms) would be ok.
Startup Time	The length of time the sensor can communicate from powered -on to communicating with Modbus. Range of 10*(100ms) would be ok.
Measurement Number	Collect 0 to 10 measurements in RS485 mode. Since pH sensor has two kinds of sensor registers. We select 2 here.



Work Mode	Select Periodic collect mode: Periodically collect and upload data.
Measurement Setting	Set the register of the measurement value and other configurations.

Measurement Setting

Set each measurement in turn. Measurement1 (**pH value**)

Register Address	The register address of the measured value in the sensor, which is an integer. The pH value register address is 1. Enter 1 here.
Function Code	Modbus function code, select 03 here.
Data Type	The data type determines the number of registers read from the sensor and how the data should parse the value. Select Signed 16bit integer, 0xAB here.
Precision	Precision of the value. You can choose the decimal place of the measurement value. If 1 is selected, one decimal place is reserved. Select 2, #.## here.
Y= Ax + B	<p>“Y”: It is the value of Data Logger will upload.</p> <p>“x”: It is the original current value.</p> <p>Factory A: Custom values that can be scaled up or down by multiples of the “x”.</p> <p>Factory B: A custom value that increments or diminishes the value of the “x”.</p> <p>By setting the values of A and B, you can calculate the desired value. If only raw values are uploaded, set A=1 and B=0.</p> <p>Factory A is 0.01 and Factory B is 0.</p>
Write Strategy	<p>This function is enabled only for some special sensors and is generally disabled by default</p> <p>After reading the value of the register, special instructions can be issued to the sensor, such as the instruction to empty the register after reading register 0.</p> <p>None: Off by default.</p> <p>After Read: Send the RS485 command to sensor after reading the register.</p> <p>On New Data: Send the RS485 command to sensor every 24 hours.</p> <p>We don't need to write strategy so we select None here.</p>



Measurement2 (Temperature value of convert box)

Register Address	Enter 0 here.
Function Code	Select 03 here.
Data Type	Select Signed 16bit integer, 0xAB here.
Precision	Select 2, #.## here.
Y= Ax + B	Factory A is 0.01 and Factory B is 0.
Write Strategy	We don't need to write strategy so we select None here.

After the configuration information is completed, click "Back to Home" (at this time, the node and the APP Bluetooth will be automatically disconnected), and the Data Logger will try to connect to the network (the LED indicator flashes red slowly when trying to connect to the network, and flashes green quickly after the network is successfully connected);

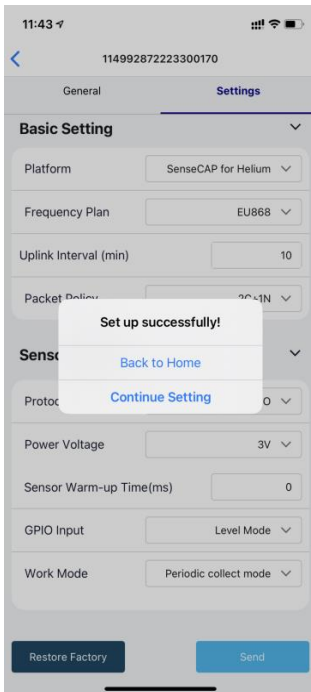



4. Check data on the SenseCAP Portal

4.1 Bind Sensor to SenseCAP Portal

Please open SenseCAP Mate App.

(1) Scan QR Code

- 1) Click “Add device” on the upper-right corner of device page to enter the device binding page.

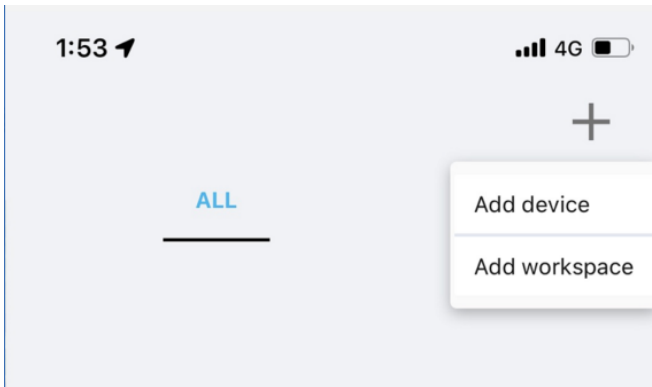

- 2) Scan the QR code on the device to bind the device to your account. If you do not set it to a designated group, the device will be put into the “default” group.

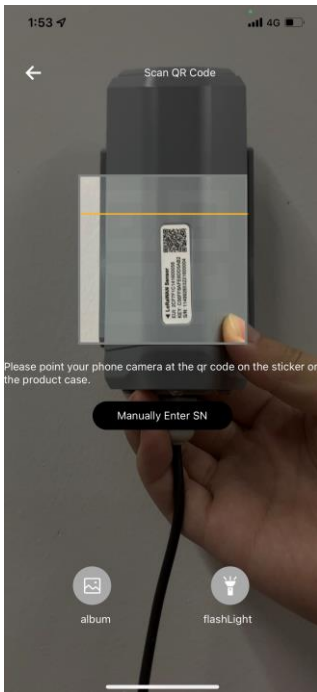



(2) Manually fill in the EUI

If the QR code sticker is damaged, you can manually fill in the EUI of the device to bind the device to your account. Please make sure you put in the EUI in the format suggested by the system and then click “confirm”.

1:58 4G

Entering Device

First EUI Line 2CF7F1 (6/16)

Second CODE Line ()

1 2 3

4 5 6

7 8 9

A B C

D E F

Clear 0 Delete

Confirm

LoRaWAN Sensor

EUI: 2CF7F12041000003

KEY: E4F15C10A50FABFB

S/N: 1149928462219000001

4.2 Check Data on SenseCAP Portal

On the SenseCAP App or the website <http://sensecap.seeed.cc/> , you can check the device online status and the latest data. In the list for each Sensor, you can check its online status and the time of its last data upload.

SENSECAP

English | xfactory.SZ@seeed.cc

Dashboard

Devices

Gateway

Node Group

Sensor Node

Data

Table

Graph

Security

Access API keys

Devices / Sensor Node

All LoRa NB-IoT

EUI Device EUI Frequency(MHz) Frequency

Device Group Device Group Online Status Online Status

Registration Time From To 1Day 7Days 30Days

Search Clear The number of search results: 4

NO.	EUI	Device Name	Sensor Count	Device Group	Online Status	Operation	Last Message Time
1	2CF7F12210400070	CO2 Sensor	1	station-1	Online	Move	2019-11-15 10:28:16
2	2CF7F12210400074	Barometric Pressure Sensor	1	station-1	Online	Move	2019-11-15 10:09:27
3	2CF7F1221040007E	Light Intensity Sensor	1	station-1	Online	Move	2019-11-15 09:43:47
4	2CF7F12210400083	Air Temperature and Humidity Sensor	1	station-1	Online	Move	2019-11-15 10:02:47



Also, you can check the date on SenseCAP Mate APP.

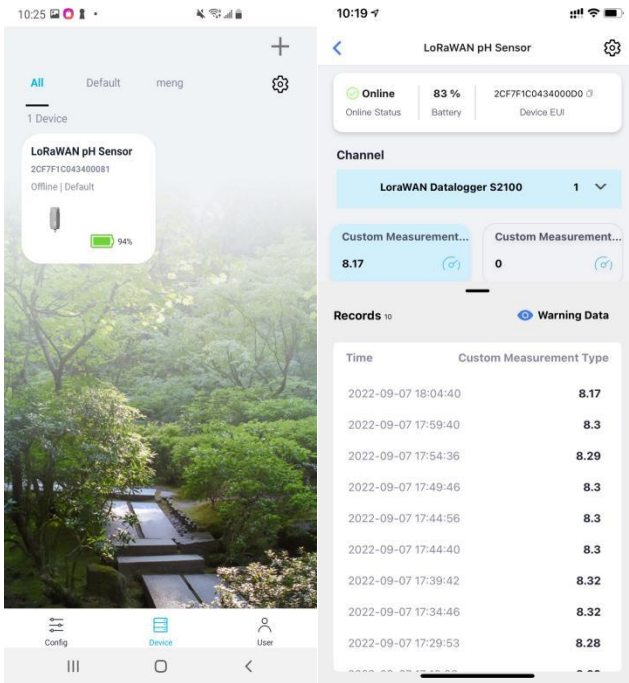



5. Support

Support is provided Monday to Friday, from 09:00 to 18:00 GMT+8. Due to different time zones, we cannot offer live support. However, your questions will be answered as soon as possible in the before-mentioned schedule.

Provide as much information as possible regarding your enquiry (product models, accurately describe your problem and steps to replicate it etc.) and send a mail to: sensecap@seeed.cc

5.1 Document Version

Version	Date	Description	Editor
V1.0.0	9/07/2022	First edition	Kelvin Lee