



SENSECAP

THE NEW GENERATION LORAWAN SENSORS OF SENSECAP

How to Configure the Analog Sensor for S2100 Data Logger

Version: v1.0.0



Table of Contents



1. Preparation	2
1.1 Sensor Probe.....	2
1.1.1 Tools	2
2. Connect the Sensor Probe	3
2.1 Disassemble the Data Logger.....	3
2.2 Power supply options of sensor	4
2.3 Connect to the Data logger	5
3. Setup the S2100	7
3.1 Connect to Sensor to App.....	7
3.2 Configure Basic parameters through App	8
3.2.1 Select the Platform and Frequency	8
3.2.2 Set the Interval.....	9
3.2.3 Set the Packet Policy.....	9
3.2.4 Restore Factory Setting	10
3.3 Configure Analog Sensor via App	11
4. Check data on the SenseCAP Portal	13
4.1 Bind Sensor to SenseCAP Portal.....	13
4.2 Check Data on SenseCAP Portal.....	14
5. Support	16
5.1 Document Version	16



1. Preparation

1.1 Sensor Probe

Get these items ready:

Picture	Type	Quantity
	Data Logger	1
	Light sensor	1

1.1.1 Tools

Type	Description
Cross screwdriver	Cross recess No.2



2. Connect the Sensor Probe

2.1 Disassemble the Data Logger

1. Unscrew three screws.

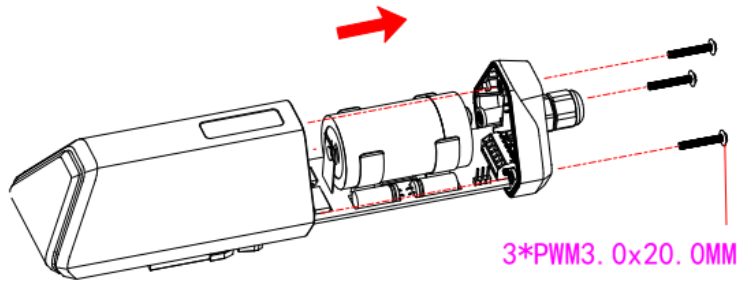

2. Take down the cover.

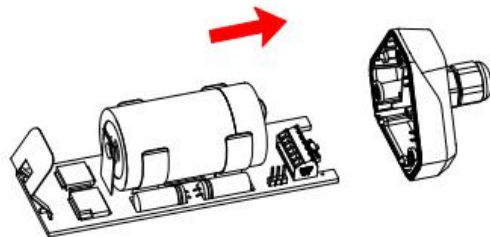

3. Remove the thread cap and pass it through the cable of the sensor, pass it through the bottom cover, and connect it to the wiring terminal.

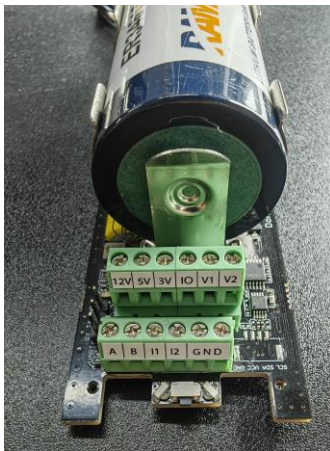



No.	Pin	Description
1	12V	External 12V input voltage. The Data Logger can be powered by an external 12V DC power supply. When using 12V power supply, the battery will serve as backup power supply.
2	5V	5V output voltage, providing 5V voltage to the sensor.
3	3V	3V output voltage, providing 3V voltage to the sensor.
4	IO	Acquisition level or pulse input
5	V1	The voltage input of 0 to 10V is collected
6	V2	The voltage input of 0 to 10V is collected
7	A	RS485 A/+
8	B	RS485 B/-
9	I1	Collect the current input from 4 to 20mA
10	I2	Collect the current input from 4 to 20mA
11	GND	Ground pin
12	GND	Ground pin

2.2 Power supply options of sensor

Data Logger supports two power supply modes, we choose the Built-in Battery mode:

Mode	Description
Built-in Battery	The Data Logger and sensors are powered by batteries. In this case, the Data Logger can be connected to a 5V sensor.



2.3 Connect to the Data logger

Wire sequence of Light sensor:

Wire Type	Description
Red Wire	5V
Black Wire	GND (11 or 12pin would be OK.)
Blue Wire	V1

1. Pass the 8-pin wire through the bottom cover and connect it to the base of the Data Logger according to the wire sequence requirements;



2. Connect the upper cover, rubber ring and screw cap in sequence





3. Tighten the screws and screw caps to check the waterproofing. If the wire diameter is too thin, add waterproof tape for winding.



***Note:** When assembling the device, it is necessary to install the waterproof pad of the Data Logger and the adapter box, and tighten the screw cap and screw, otherwise the waterproof effect of the device may be affected!

If the wire diameter is too small, it can be wrapped with waterproof tape, as shown below:





3. Setup the S2100

3.1 Connect to Sensor to App

- 1) Press button and hold for **3 seconds**, the LED will flash at 1s frequency. Please use the App to connect the sensor within 1 minute; otherwise, the device will power off or reboot.

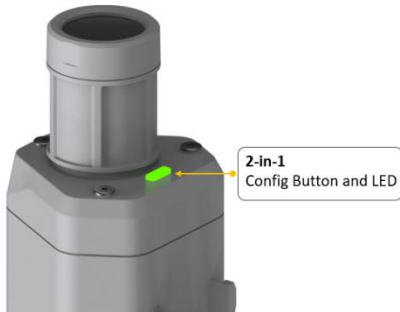

- 2) Please select “S2100 Data Logger”.

Please click the “Setup” button to turn on Bluetooth and click “Scan” to start scanning the sensor's Bluetooth.

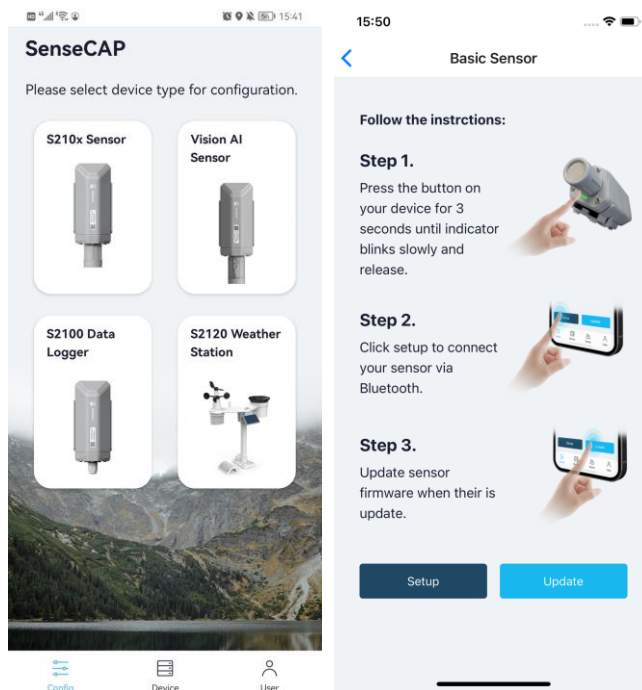

- 3) Select the Sensor by S/N (S/N is on the front label of the sensor). Then, the basic information of the sensor will be displayed after entering.

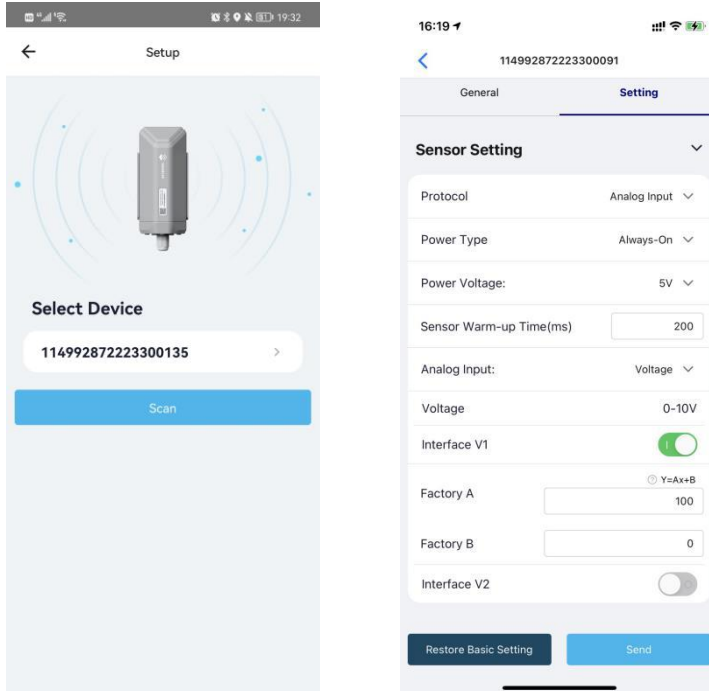

- 4) Enter configuration mode after Bluetooth connection is successful: LED flashes at 2s frequency.

3.2 Configure Basic parameters through App

3.2.1 Select the Platform and Frequency

S210x Sensors are manufactured to support universal frequency plan from 863MHz ~928MHz in one SKU. That is to say, every single device can support 7 frequency plans.

Here we select the “SenseCAP for Helium” or “SenseCAP for TTN”. The Frequency Plan based on your actual situation.

***Note:** Data Logger can upload data when there is a Helium network around the user. It runs on SenseCAP private Helium Console. Users do not need to create a device on the Helium Console;

SenseCAP for TTN platform needs to be used with SenseCAP LoRaWAN outdoor gateway(<https://www.seeedstudio.com/LoRaWAN-Gateway-EU868-p-4305.html>)

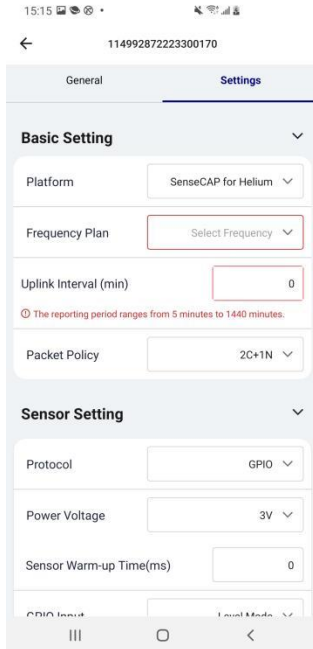

3.2.2 Set the Interval

The working mode of device: wake up the device every interval and collect measurement values and upload them through LoRa.

For example, the device collects and uploads data **every 60 minutes by default**.

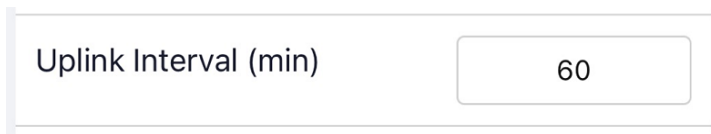

3.2.3 Set the Packet Policy

The sensor uplink packet strategy has three modes, we select 1N here or you can according to your own requirement.

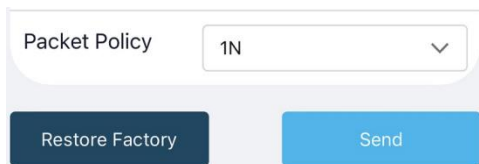

Parameter	Description
2C+1N (default)	2C+1N (2 confirm packets and 1 none-confirm) is the best strategy, the mode can minimize the packet loss rate, however the device will consume the most data packet in TTN, or date credits in Helium network.



1C	1C (1 confirm) the device will sleep after get 1 received confirm packet from server.
1N	1N (1 none-confirm) the device only send packet and then start to sleep, no matter the server received the data or not.

3.2.4 Restore Factory Setting

When selecting the SenseCAP platform, you must use the fixed EUI/App EUI/App Key. Therefore, you need to restore the factory Settings before switching back to the SenseCAP platform from other platforms.

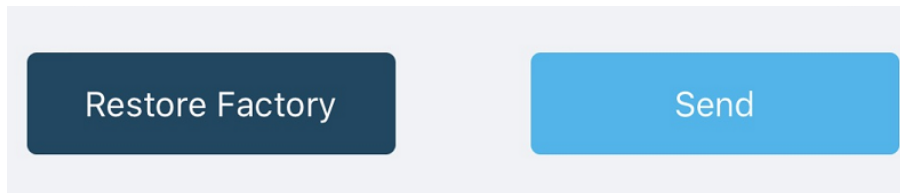

When we make a mistake or want to reset everything, we can click the button. The device will be restored to the factory's default configuration.

***Note:** The “Restore Factory” function can only reset the Basic Setting.



3.3 Configure Analog Sensor via App

Select the “Protocol” as “Analog Input”. Then set the following parameters in turn.

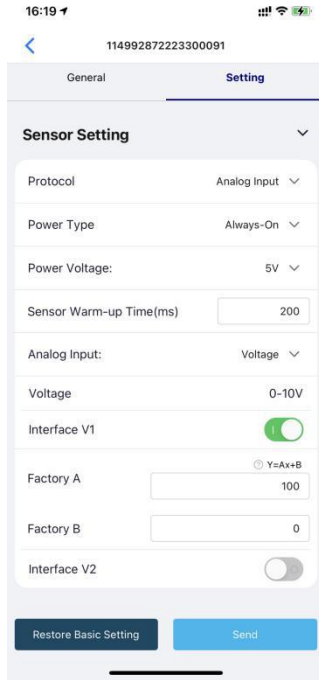

Select the Power Type as **Periodical power**.

Power Voltage	We select 5V here.
Sensor Warm-up Time	The warm-up time denotes the amount of time it takes for the sensor to attain its highest accuracy or performance level once the voltage supply has been applied. We enter 200(ms) here.
Voltage Range	0~10V (The Data Logger can collect voltage signals within 0~10V and automatically adjust the upper limit to increase accuracy). We select Voltage here.
Interface V1	The Data Logger supports two analog voltage signals. When the sensor wire is connected to V1/V2, the configuration can be enabled. We enable Interface V1 here.
Interface V2	
$Y = Ax + B$	<p>“Y”: It is the value Data Logger will upload.</p> <p>“x”: It is the original current value.</p> <p>Factory A: Custom values that can be scaled up or down by multiples of the “x”. Factory B: A custom value that increments or diminishes the value of the “x”.</p> <p>By setting the values of A and B, you can calculate the desired value. We set A as 100, B as 0 here.</p>



After the configuration information is completed, click "Back to Home" (at this time, the node and the APP Bluetooth will be automatically disconnected), and the Data Logger will try to connect to the network (the LED indicator flashes red slowly when trying to connect to the network, and flashes green quickly after the network is successfully connected);

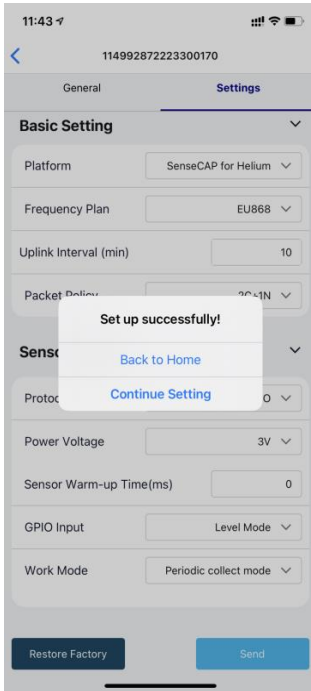



4. Check data on the SenseCAP Portal

4.1 Bind Sensor to SenseCAP Portal

Please open SenseCAP Mate App.

(1) Scan QR Code

- 1) Click “Add device” on the upper-right corner of device page to enter the device binding page.

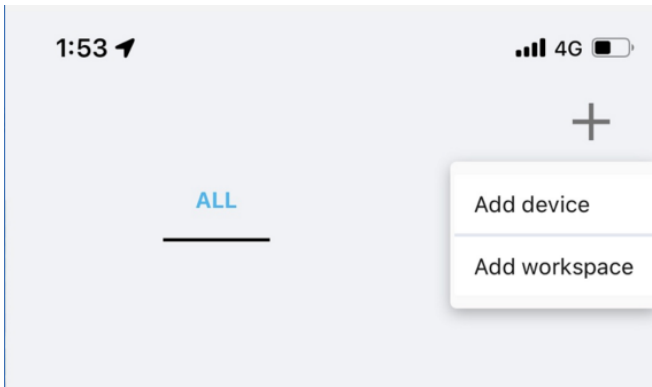

- 2) Scan the QR code on the device to bind the device to your account. If you do not set it to a designated group, the device will be put into the “default” group.

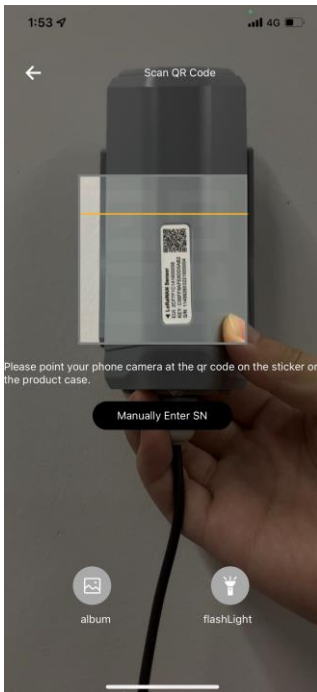



(2) Manually fill in the EUI

If the QR code sticker is damaged, you can manually fill in the EUI of the device to bind the device to your account. Please make sure you put in the EUI in the format suggested by the system and then click “confirm”.

1:58 4G

Entering Device

First EUI Line (6/16)

Second CODE Line

1	2	3
4	5	6
7	8	9
A	B	C
D	E	F
Clear	0	Delete

Confirm

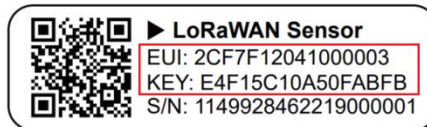

4.2 Check Data on SenseCAP Portal

On the SenseCAP App or the website <http://sensecap.seeed.cc/> , you can check the device online status and the latest data. In the list for each Sensor, you can check its online status and the time of its last data upload.

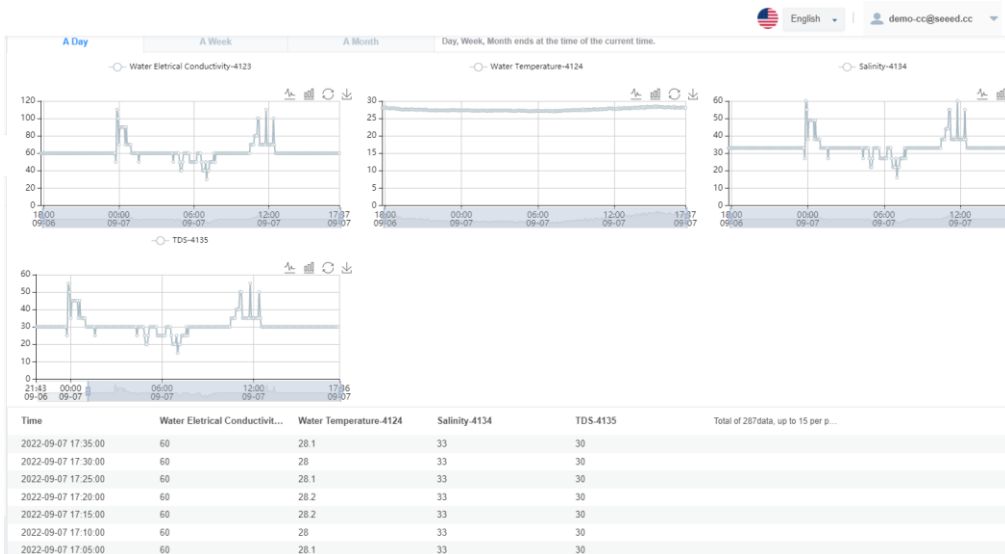



Also, you can check the date on SenseCAP Mate APP.

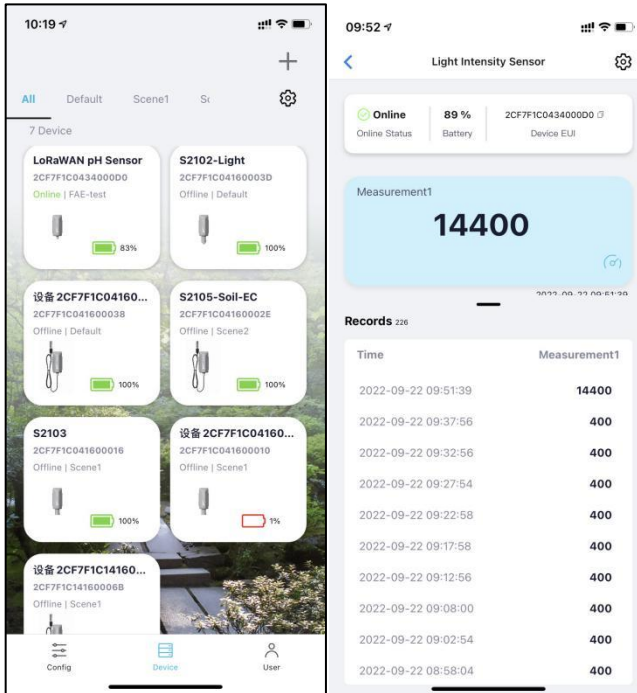



5. Support

Support is provided Monday to Friday, from 09:00 to 18:00 GMT+8. Due to different time zones, we cannot offer live support. However, your questions will be answered as soon as possible in the before-mentioned schedule.

Provide as much information as possible regarding your enquiry (product models, accurately describe your problem and steps to replicate it etc.) and send a mail to: sensecap@seeed.cc

5.1 Document Version

Version	Date	Description	Editor
V1.0.0	10/09/2022	First edition	Kelvin Lee