

ORECK[®] XL[®]

S I M P L Y A M A Z I N G[®]



USA: 1-800-989-3535
CANADA: 1-888-676-7325



WWW.ORECK.COM



USER'S GUIDE COMMERCIAL U2000RB-1

HIGH SPEED UPRIGHT VACUUM
CLEANER WITH
MicroSweep[®]
CLEANING SYSTEM

• IMPORTANT •

SAVE THIS BOOKLET!

Includes:

- Safety Warnings
- Warranty
- Operating Instructions
- Trouble Diagnosis
- Accessories

**BEFORE OPERATING
CLEANER, READ ALL
INSTRUCTIONS IN THIS
MANUAL CAREFULLY.**

Table of Contents

Maintenance and Customer Service,
Important Safety Instructions page 2

Warranty, Grounding Instructions,
Motor Protection - Vacuum Shutdown . . . page 3

Assembly,
Operating Instructions page 4

Operating Instructions cont.,
To Replace Paper Filter Dust Bag page 5

Stuffing or Blockage,
Using an Oreck Fresh Air® Tab page 6

To Adjust or Replace Brush,
Troubleshooting Guide page 7

**Maintenance and
Customer Service**

Your ORECK vacuum cleaner is a product of precise engineering. The motor bearings are permanently lubricated and should not be oiled. If you require additional information or have problems with your ORECK appliance, you may call ORECK commercial customer service at:

USA: 1-800-989-3535
Canada: 1-888-676-7325

Please specify the model number and serial/code number which can be found on the data plate on the back of the vacuum.

Save your sales or purchase slip. Should your ORECK appliance require warranty service in the U.S.A., present this slip to the Authorized Service Center as your proof of purchase date or, in Canada, call customer service.

**Accessories
Sold Separately**

USA: 1-800-989-3535
Canada: 1-888-676-7325

ITEM	PART #
1. Dust Bag, 25 Pack, Regular	PK800025
2. Oreck Fresh Air® Tabs	AIR TABS

**IMPORTANT
SAFETY INSTRUCTIONS**

When using an electrical appliance, basic precautions should always be followed, including the following:



**READ ALL INSTRUCTIONS BEFORE
USING THIS VACUUM CLEANER
WARNING**

**To reduce the risk of fire,
electric shock, or injury:**

- Do not leave appliance unattended when plugged in. Unplug from outlet when not in use and before servicing.
- Do not use outdoors or on wet surfaces.
- Do not operate the unit while in the upright and locked position.
- Do not let the unit run while in any one stationary position for any period of time. Keep the unit moving while in operation.
- Do not allow to be used as a toy. Close attention is necessary when used near children.
- Use only as described in this manual. Use only manufacturer's recommended attachments.
- Do not use with damaged cord or plug. If appliance is not working as it should, has been dropped, damaged, left outdoors, or dropped into water, return it to a service center or call customer service at:
USA: 1-800-989-3535
Canada: 1-888-676-7325
- Do not pull or carry by cord, use cord as a handle, close door on cord, or pull cord around sharp edges or corners. Keep cord away from heated surfaces.
- Do not run appliance over cord.
- Do not unplug by pulling on cord. To unplug, grasp the plug, not the cord.
- Do not handle plug or appliance with wet hands.
- Do not put any object into openings. Do not use with any opening blocked; keep free of dust, lint, hair and anything that may reduce air flow.
- Keep hair, loose clothing, fingers and all parts of body away from openings and moving parts.
- Do not use to pick up anything that is burning or smoking, such as cigarettes, matches, or hot ashes.
- Do not use without filter bag assembly in place.
- Turn off all controls before unplugging.
- Use extra care when cleaning on stairs.
- Do not use to pick up flammable or combustible liquids, such as gasoline or lighter fluid, or use in areas where they may be present.
- Do not use appliance in an enclosed space where flammable, explosive or toxic vapors are given off by oil base paint, paint thinner, some mothproofing substances, or in an area where flammable dust is present.
- Do not pick up toxic material such as chlorine bleach, drain cleaner, gasoline, etc. with this appliance.
- Use caution when vacuuming over area rug edges and fringe.
- Your appliance is provided with an extension cord. In case of damage or loss of function, only replace this extension cord with an SJT type, rated 300 Volt - 105 degrees C (221 degrees F), 3 wire grounded, #18 AWG (American Wire Gauge), no longer than 50 feet. Failure to use the proper cord could result in fire or electric shock.
- Keep cord away from heated surfaces.

**SAVE THESE INSTRUCTIONS
For Commercial Use**

WARNING: Product contains chemicals known to the State of California to cause cancer and birth defects or other reproductive harm.

Warranty

Techtronic Floor Care Technology gives you the following limited warranty for this product only if it was originally purchased for residential use, not for resale, from Oreck® or an Oreck® Authorized Retailer.

Oreck® will repair or replace, free of charge, to the original purchaser, any part that is found to be defective in material or workmanship within six (6) years following the date of purchase for all residential models. NOTE: If the unit is used commercially, a one (1) year overall warranty applies. This limited warranty does not cover the replacement of expendable or consumable parts such as filters, cartridges, and other parts subject to normal wear unless they are defective in material or workmanship.

This limited warranty does not apply to any part subjected to accident, abuse, commercial use, alteration, misuse, damage caused by an act of God, the use of voltages other than on the data plate of this product or service of this product by other than Oreck® or a participating Factory Authorized Service Center.

Oreck® does not authorize any person or representative to assume or grant any other warranty obligation with the sale of this product.

Oreck®'s limited warranty is valid only if you retain proof of purchase from Oreck® or an Oreck® Authorized Retail Dealer for this product. If you purchase this product from any other source, your purchase is "AS IS," which means Oreck® grants you no warranty, and that you, not Oreck®, assume the entire risk of the quality and performance of this product, including the entire cost of any necessary servicing or repairs of any defects.

Oreck®'s liability for damages to you for any costs whatsoever arising out of this statement of limited warranty shall be limited to the amount paid for this product at the time of original purchase, and Oreck® shall not be liable for any direct, indirect, consequential or incidental damages arising out of the use or inability to use this product. Some states do not allow the exclusion or limitation of incidental or consequential damages, so the above limitation or exclusion may not apply to you.

ALL EXPRESS AND IMPLIED WARRANTIES OTHER THAN THE LIMITED WARRANTY SET FORTH ABOVE, FOR THIS PRODUCT, INCLUDING IMPLIED WARRANTIES OF MERCHANTABILITY AND FITNESS FOR A PARTICULAR PURPOSE ARE EXPRESSLY DENIED.

This warranty gives you specific legal rights, and you may also have other rights which vary from state to state.

Grounding Instructions

This appliance must be grounded. If it should malfunction or break down, grounding provides a safe path of least resistance for electrical current, reducing the risk of electric shock. The cord for this appliance has an equipment-grounding conductor and a grounding plug. It must only be plugged into an electrical outlet that is properly installed and grounded in accordance with all local codes and ordinances.

DANGER: Improper connection of the equipment-grounding conductor can result in a risk of electrical shock. Check with a qualified electrician or service person if you are in doubt as to whether the outlet is grounded. If not, have a proper outlet installed by a qualified electrician.

This appliance is for use on a nominal 120-volt circuit. It has a grounding plug similar to the example shown. Make sure the appliance is connected to an outlet with the same configuration as the plug. No adapter should be used with this appliance.

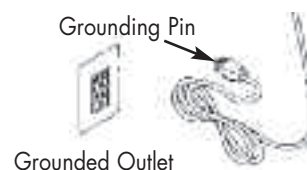

Motor Protection - Vacuum Shutdown

If the vacuum becomes overloaded, which could occur by sucking up a large obstruction or on extremely thick carpet, the electronics are designed to shut down the vacuum. If this happens, the vacuum will be turned off. To reset the vacuum turn the unit off, wait 5 seconds, and then turn it back on. If it shuts down again there may be a large obstruction in the vacuum. See page 6 for the steps on clearing a blockage.

Assembly

To assist you in identifying components of your vacuum, the parts have been numbered as follows:

- 1 Handle section, upper
- 2 Tube, lower
- 3 Power head
- 4 Outer bag
- 5 Paper filter dust bag
- 6 Power cord
- 7 Retaining spring
- 8 Bag tension bar
- 9 Zip fastener
- 10 ON/OFF switch
- 11 Cord hook
- 12 Plastic loop/cable clamp
- 13 Connector Assembly/Rear Carry Handle
- 14 Fan housing
- 15 Cord assembly
- 16 Cord-Lock
- 17 Pigtail

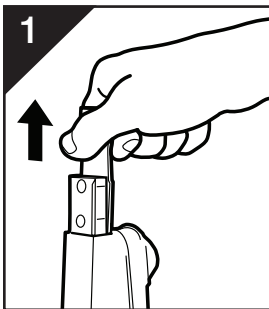
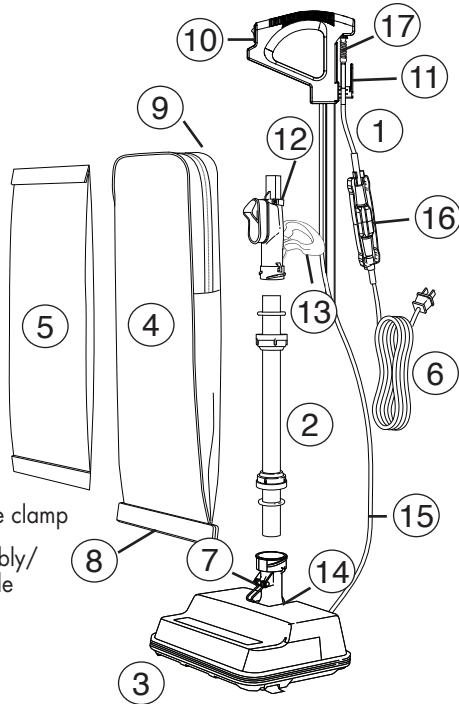

Before assembling appliance, remove two screws from the connector assembly. Remove plastic insert by pulling upward.

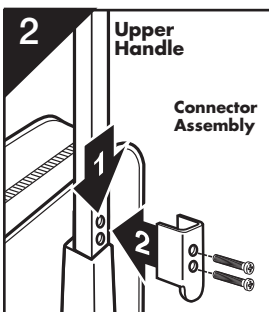

With ON/OFF switch facing the front of the unit, slide upper handle section over matching section of the connector assembly. Place brace against handle and connection assembly aligning the holes. Insert one screw into top hole and one screw into the bottom hole then tighten firmly until handle is no longer loose.

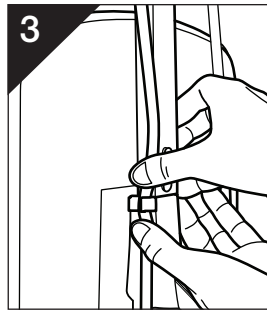

Attach cord to cord clip by pressing cord above and below clip ensuring the cord is fully rested in clip.

Operating Instructions

To Operate

Make sure disposable paper filter dust bag is in place. **DO NOT** operate the cleaner without a paper filter dust bag. Plug the power cord into an electrical outlet and press the **ON (I) - OFF (O)** switch on Helping Handle Assembly, or on top of base for Straight Handle Models when ready to operate.

General Information

The performance of your new cleaner greatly depends upon care and maintenance. The instructions in this manual will guide you in performing basic care and maintenance. To obtain the most satisfying years of service read the instructions and keep them handy for future reference.

Operating Recommendations

This new ORECK XL High-Speed Upright gets under things, and it's SO lightweight and easy to use.

The following are a few simple suggestions regarding its operation:

1. When inserting a new disposable paper filter dust bag—**FIRST PUFF OUT** and **OPEN THE BAG**.
2. When the disposable filter dust bag is full, **REPLACE IT**.
3. If at any time the machine does not pick up properly or makes an unusual noise, **STOP OPERATION** and service.
4. Although your upright will pick up pins, paper clips, and other small objects, it is recommended that these be removed from the floor before you vacuum. Failure to do so may result in permanent damage to the motor suction fan and its housing.
5. **WARNING:** Do not use your vacuum cleaner on damp or wet surfaces. This will cause damage to the vacuum cleaner and is dangerous to the user. Damage caused by use on wet or damp surfaces is not covered under warranty.
6. Change the disposable filter dust bag at least once a month—even if it is not full! The collected dust in the dust bag can cause odor, attract moisture, act as a breeding area and can affect the efficiency of the cleaner.
7. **DO NOT run the vacuum cleaner over cord. The revolving brush could damage the cord.**
8. Use caution when vacuuming over area rug edges & fringe.

Disposable Paper Filter Dust Bags

Disposable paper filter dust bags play a very important role in the

efficiency of your ORECK vacuum cleaner. The purpose of the filter bag is to trap dirt, but at the same time it must be porous enough to allow air to pass through. If the filter bag becomes clogged, no air can pass through the cleaner and cleaning cannot take place, regardless of the cleaner's power. Increase the CLEANING POWER of your cleaner by changing the bag often.

To keep your cleaner operating at maximum efficiency, change the dust bag frequently. DO NOT FILL ABOVE THE LINE INDICATED ON THE DUST BAG.

Be sure the disposable paper filter dust bag is installed properly.

All paper dust bags are not the same. Your ORECK disposable dust bags have been designed to be used with the ORECK cleaner. Using bags other than genuine ORECK disposable bags will affect the cleaning ability of your cleaner and could cause damage to it.

The Belt

This vacuum is equipped with the EnduroLife Belt, which is designed for long life and doesn't need changing. If the vacuum sucks up a large obstruction, the EnduroLife Belt is designed to shut the upright down.

! WARNING: Unplug cord from electrical outlet before servicing.

1. Clear any large obstruction or blockage from the vacuum. (See Page 6, "Stuffing or Blockage")
2. Once the blockage is cleared, plug the vacuum back in and it will reset.

NOTE: If the vacuum continues to shut down, contact an Oreck Authorized Service Center.

Lubrication

The vacuum cleaner motor bearings are factory lubricated and sealed. Further lubrication is not required.

General Cleaner Care

At least once a month, check for and remove excessive lint, string or hair from revolving brush.

Wipe the outside of the cleaner with a damp cloth. Also, clean the connector deflector assembly area, base of cleaner and fan housing area. If there is dust in the outer bag, vacuum it or shake it out.

A little preventative maintenance will keep your cleaner looking new and will ensure continued cleaning effectiveness.

CAUTION—Wood Floors, Soft (Vinyl, Asphalt Tile, etc.) Floor Surfaces and Polished Floor Finishes
Use low speed for hard surfaces and fine rugs.

Use floor and floor finish manufacturer's recommended methods of cleaning. The metal strip on the base of the cleaner could be damaged if used on concrete or abrasive surfaces, and, therefore, cause damage to wood floors, soft (vinyl, asphalt tile, etc.) floor surfaces and polished floor finishes. The roller brush may also scuff very soft finishes. Do not operate the unit while in the upright and locked position. Do not let the unit run while in any one stationary position for any period of time. Keep the unit moving while in operation.

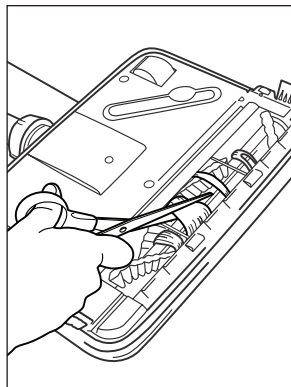

To Replace Filter Dust Bag

! WARNING: Unplug cord from electrical outlet before servicing.

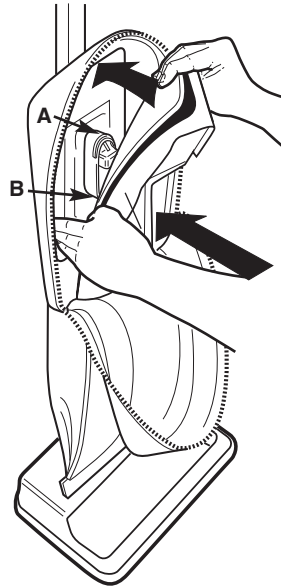

BAG INSTALLATION:

1. Hook bottom of bag collar opening under lip "B" of connector assembly. Pull up on bag collar and snap over lip "A" of connector.
2. Press on edges of bag collar to insure bag is completely installed.

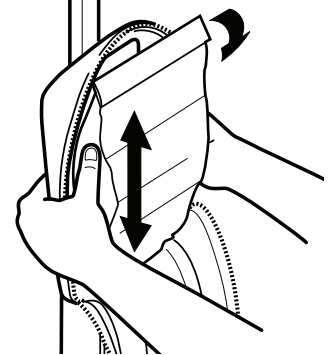

IMPORTANT: Check to make sure bag collar is behind lips "A" and "B". If it is not, dust will leak into outer bag. When filter bag is in place, close outer bag with zipper fastener.

Stuffing or Blockage

Under certain conditions it is possible to stuff or block the intake tube and the lower tube assembly. If your vacuum cleaner does not pick up properly, or makes unusual noise and the outer bag does not fluff up or balloon open, follow the following steps:



WARNING: Unplug cord from electrical outlet before servicing.

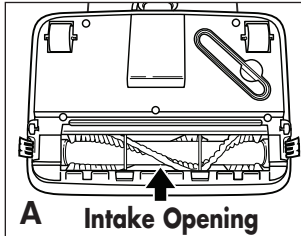

1. Check for blockage at the mouth of the intake opening. See illustration A. If there is blockage, remove it with long-nose pliers, a screwdriver or coat hanger. If you can not reach the blockage, remove baseplate. See illustration B.

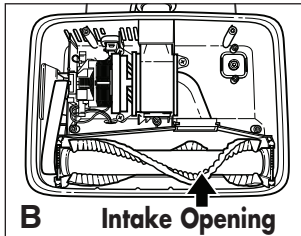

2. If the blockage is not at the base, remove lower tube. See illustration C. Unhook retainer spring, releasing bottom of bag. Twist lower collar counterclockwise to slide up. Pull tube out of base. Check for blockage. If blockage is in the tube, remove with a coat hanger.

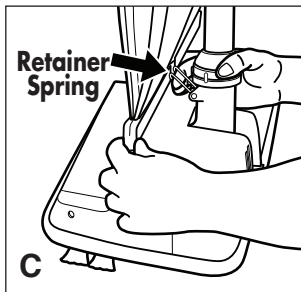

3. If tube is not blocked, look into fan housing. See illustration D. Remove debris with long-nose pliers, a screwdriver or coat hanger.

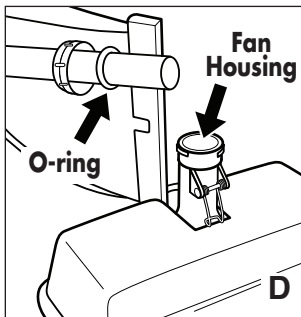

4. To reassemble, check O-ring on tube, and replace if damaged. Vacuum will not operate properly without the tube O-ring. Slide O-ring to approximately 2" from base of tube. Replace tube by first lining up slot at base of tube with inner tab inside fan housing. Then reinsert tube and push down until the tube is seated. Make sure O-ring is in place against fan housing opening. Replace and tighten collar until collar locking tabs are locked in place. See illustration E. Make sure collar is not cross threaded on housing.

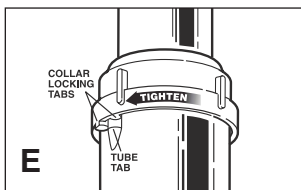

5. Many times blockage occurs due to a full dust bag causing dirt to back down the air flow system. When that happens, the blockage will be at the top of the system, starting in the area where the dust bag connects to the connector assembly. See illustration F.

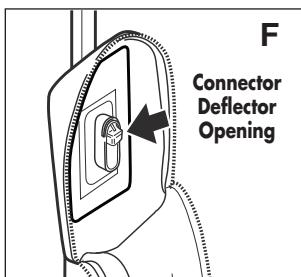

NOTE: If the above actions do not correct the problem, contact an ORECK authorized service center or call the commercial customer service center.

USA: 1-800-989-3535

Canada: 1-888-676-7325

IMPORTANT: On plush and new carpets, stuffing may occur due to excessive fuzz and loose cuttings in the carpet. Stuffing could occur for the first few cleanings until all the loose material is removed. Due to the high efficiency of the cleaner, many older carpets will cause stuffing when the cleaner is first used on them.

Using an Oreck Fresh Air® Tab

Your ORECK XL vacuum cleaner has a special FRESH AIR tab pocket. This pocket is located inside the outer bag in the area where the disposable paper bag attaches to the intake tube. Insert tablet in pocket.

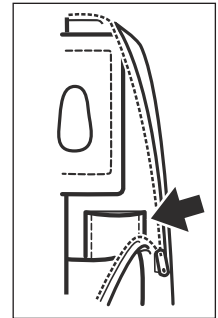

Cord-Lock Instructions



WARNING: Unplug cord from electrical outlet before servicing or removing cord-lock.

Assembly:

1. Connect plug and receptacle.
2. Snap cord into lock.
3. Rotate insert until secure against plug.
4. Ensure rotation is as depicted to ensure proper engagement.

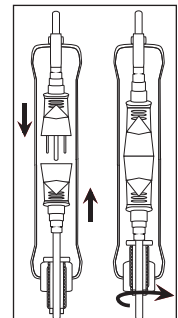

Disassembly:

1. Remove cord from lock
2. Disconnect plug and receptacle.

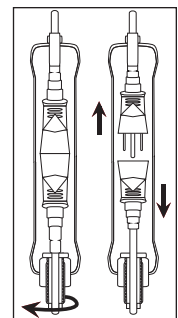

To Adjust or Replace Brush

! WARNING: Unplug cord from electrical outlet before servicing.

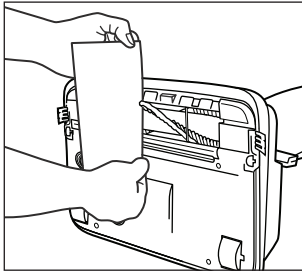

To determine if the brush is worn, place a firm straight edge across the nozzle opening. If brush bristles do not extend beyond baseplate, brush should be adjusted.

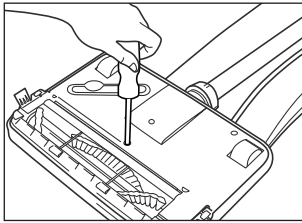

Remove the baseplate by removing 5 screws. Then, remove the belt and brush roll from the housing.

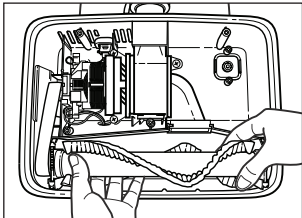

Rotate both bearing assemblies at ends of brush roll to show "OLD" and replace in the holding channels in the housing.

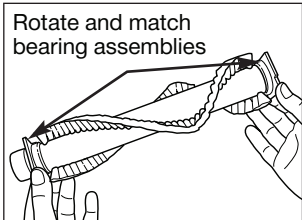

Rotate and match bearing assemblies

NOTE: The bearing assembly setting marked "OLD" has two notches (II) on the top of the assembly. The one marked "NEW" has one notch (I). When rotating bearings, make sure both bearing assembly settings are the same and face up when replacing the brush roll.

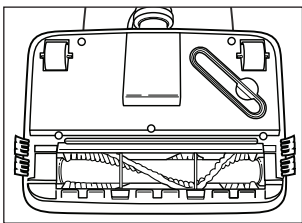

Reassemble the belt and the baseplate and check bristle height above baseplate at each end of brush.

IMPORTANT: Unless the brush is worn as indicated above, both bearings must be in the "NEW" position. When rotating, both bearings must be in the "OLD" position. Unmatched settings will cause damage to your machine.

If a previous adjustment has already been made and bristle height does not extend above baseplate, a new brush assembly should be ordered.

Troubleshooting Guide

! WARNING: Unplug cord from electrical outlet before servicing.

SAVE SERVICE CALLS...CHECK THESE FIRST:

- Is the disposable filter dust bag full?
- Are pores of filter dust bag clogged with powder or fine dust?
- Is anything clogging the revolving brush, lower tube, intake opening, fan housing or connector assembly opening?
- Is the belt in place and turning the brush?
- Are the brush ends in the proper location?
- Does the brush turn freely? Are hair, string or rug fibers wound around the brush?

PROBLEM	POSSIBLE SOURCE	AREAS TO CHECK
CLEANER WILL NOT RUN	Not plugged in properly.	Be sure cleaner is firmly plugged into wall outlet.
	No electricity in wall outlet.	Check electrical source—fuse or circuit breaker.
	Brushroll is jammed and motor shut off.	Clear obstruction. Upright can be reset by unplugging or switching the ON/OFF button once.
CLEANER DOES NOT PICK UP	Filter bag is full.	Replace filter bag. See "To Install Paper Filter Dust Bag."
	Nozzle or intake pivot clogged.	Clear obstruction.
	Brush is worn.	See "To Replace or Adjust Brush."
	Tube clogged.	Clear obstruction.
	Bag pores are clogged with fine dust.	Change bag.
	Impeller fan is broken.	Return to Service Center for repair.
Revolving brush is not even at both ends.	Check brush roll end cards. Make sure words "old" or "new" match at each end.	

ALL OTHER SERVICING SHOULD BE DONE BY AN ORECK AUTHORIZED SERVICE CENTER.

CALL COMMERCIAL CUSTOMER SERVICE HOT LINE

USA: 1-800-989-3535

CANADA: 1-888-676-7325

Whenever calling, please be sure to have your model and serial number from data plate.

