



# C4

1U Passive Air Cooler

**PRODUCT SPECIFICATIONS**

Specification Version: 12/21/2023

*(Specifications are subject to change without notice)*

## Model Number: C4

- Recommend for Intel® CPU as following
  - Intel® Granite Rapid AP (Socket LGA 7529)
- Passive Air Cooler for 1U Server and Up

## Overall Specification

Dimension	126.8 x 97.8 x 26.8 mm
Weight	450g
Material	Copper fins with copper vapor chamber
Thermal Grease	Shin-Etsu X23-8079-2 Pre-Printed
TDP	400 W

## Performance Chart: Passive Cooler C4 Thermal Resistance Thermal Resistance & Pressure Drop vs. Air Flow rate

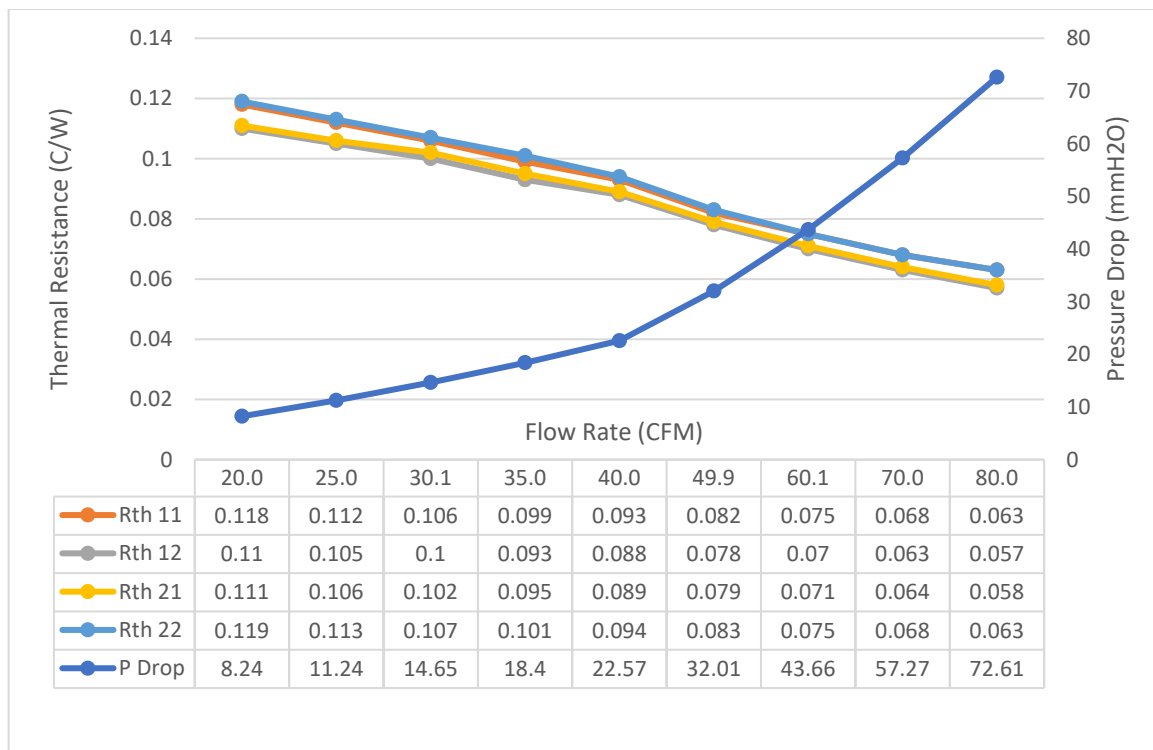

## C4 | Socket LGA 7529

### Publication History:

12/20/2023: Initial Release.

*(Specifications are subject to change without notice)*



4

3

2

1

REV#	DESCRIPTION	CHECKER	DATE
0.0	INITIAL RELEASE	JUN	12/19/23

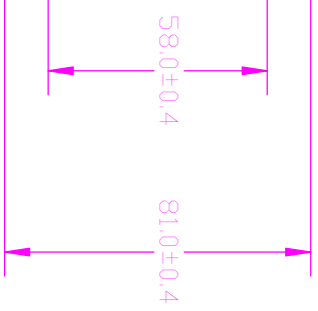
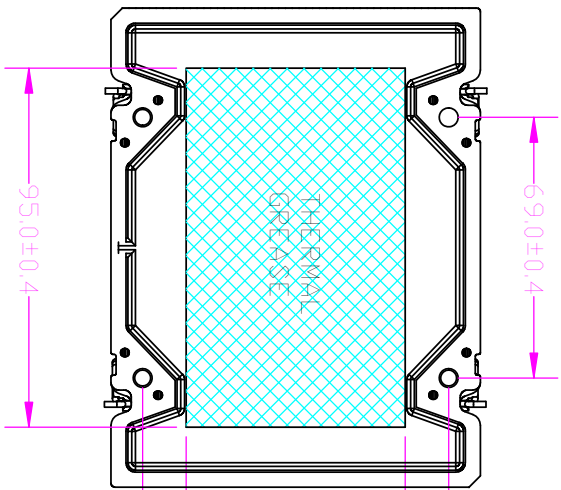
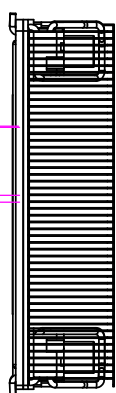
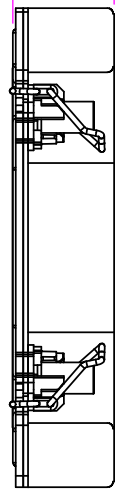
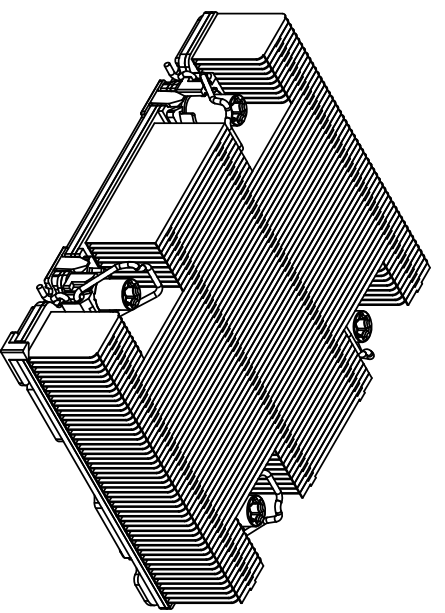
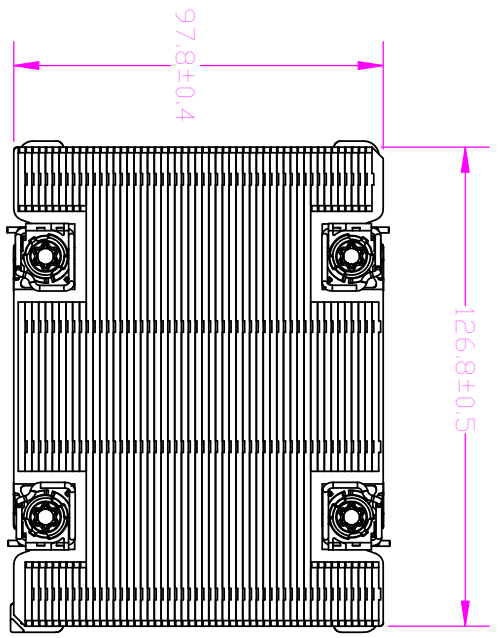

THE THERMAL GREASE

NAME	DATE
DRAWN BY JUN	12/21/2023
CHECKED BY JUN	12/21/2023
ENG.APPROVED	
MFG.APPROVED	



DYNATRON CORPORATION

TOP MOTOR

1U AIR COOLER C4  
OVERALL DIMENSION DRAWING

CONFIDENTIAL DOCUMENT

THIS DRAWING CONTAINS INFORMATION PROPRIETARY TO DYNATRON CORPORATION AND QUALIFICATION INDUSTRIES, LTD. ALL RIGHTS RESERVED.

VIEW



DWG. No:

REV.

2

1

DATE  
12/19/23

B

1
1
1
N/A
QTY.

A

ION  
wing  
REV  
0,0