

DBPOWER

FULL HD 1080P PROJECTOR RD-828

USER MANUAL

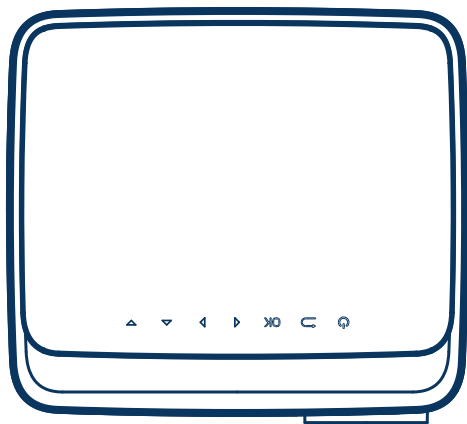

Power Your Life

ACTIVATE YOUR 12-MONTH WARRANTY & GET EXCLUSIVE GIFT

Register within 7 days after receiving your new product.

PLEASE VISIT US NOW

→ warranty.dbpowershop.com

CUSTOMER SERVICE

✉ support@dbpowershop.com 🌐 www.dbpowershop.com



NOTE

1. Please note that it is suitable for use only in a totally dark environment. NOT for presentation purposes.
2. Dolby Audio is NOT supported.
3. DO NOT block the air vents during the use, UNPLUG from the power source & PREVENT DUST from entering the appliance when it is not in use.

A Big Thank You

Thank you for choosing Full HD 1080P PROJECTOR RD-828 and becoming our valued customer. At DBPOWER, we're committed to providing you with products that enhance your daily life. Happy customers make us proud and we hope that this product will bring you the most convenient and enjoyable experience. If you have any questions or feedback on your new product, just contact our customer support team at 1-855-888-5533, or via email at support@dbpowershop.com

Enjoy your new product!

FCC Warning

This device complies with part 15 of the FCC rules. Operation is subject to the following two conditions:

(1) this device may not cause harmful interference, and (2) this device must accept any interference received, including interference that may cause undesired operation.)

The manufacturer is not responsible for any radio or tv interference caused by unauthorized modifications or change to this equipment.

Such modifications or change could void the user's authority to operate the equipment.

This equipment has been tested and found to comply with the limits for a Class B digital device, pursuant to part 15 of the FCC Rules.

These limits are designed to provide reasonable protection against harmful interference in a residential installation. This equipment generates, uses and can radiate radio frequency energy and, if not installed and used in accordance with the instructions, may cause harmful interference to radio communications. However, there is no guarantee that interference will not occur in a particular installation. If this equipment does cause harmful interference to radio or television reception, which can be determined by turning the equipment off and on, the user is encouraged to try to correct the interference by one or more of the following measures:

- Reorient or relocate the receiving antenna.
- Increase the separation between the equipment and receiver.
- Connect the equipment into an outlet on a circuit different from that to which the receiver is connected.
- Consult the dealer or an experienced radio/TV technician for help.

RF warning statement:

The device has been evaluated to meet general RF exposure requirement. The device can be used in portable exposure condition without restriction.

CONTENTS

| | |
|--|----|
| Important Safeguards | 01 |
| Projector Scheme | 02 |
| Remote Control | 04 |
| Projector Installation | 05 |
| Standard Setting | 05 |
| Installation Method | 06 |
| Turn the Projector On/Off | 07 |
| Focusing | 07 |
| Menu Settings | 08 |
| How to Select the Source | 08 |
| How to Connect to WiFi | 08 |
| How to Adjust the projected image | 10 |
| How to Use iOS Cast (Apple device) | 11 |
| How to Use Miracast (Android device) | 12 |
| How to Play media files from a USB Drive | 13 |
| Supported Multimedia File Formats | 13 |
| Troubleshooting | 14 |
| Specifications | 15 |

IMPORTANT SAFEGUARDS

Read the instruction manual carefully before using your RD-828 and save it for future reference.

Installation

- To get the best watching experience, use your projector in a darkened room.
- Please use the projector carefully, dropping or crashing may damage its internal components.

Power

- Be careful while using the power cord, avoid excessive bending; the damage of power cable may cause electric shock and fire.
- Unplug the power cord if the projector is powered off and not in use.

Cleaning

- Unplug the power cord.
- Clean the outer surface of the projector regularly with a damp cloth. Neutral detergent can be used.
- Please wipe the lens down with the microfiber cloth to prevent scratches.
- Please clean projector's vents and speakers regularly by banister brush.

Attention! High Temperature

- Avoid touching the projector ventilation (inlet) if the appliance is in use or was in use recently to prevent burns and scalds.
- Please do not look into the lens directly while the projector is turned on, it may cause damage to your eyes.

***Tips**

- Please do not disassemble the projector by yourself, otherwise it will void your warranty.
- Please keep the projector away from water or any other liquid as it is not waterproof.
- Please do not put the projector in wet or moist conditions to prevent electric shock.
- To ensure the stability of heat dissipation, please adjust tilt foot of the projector before starting.

PROJECTOR SCHEME

The projector can display Full HD video signal, composite video signal, and supports stereo audio signal input and output. Please refer to the following figure to connect the projector and other audio equipment correctly.

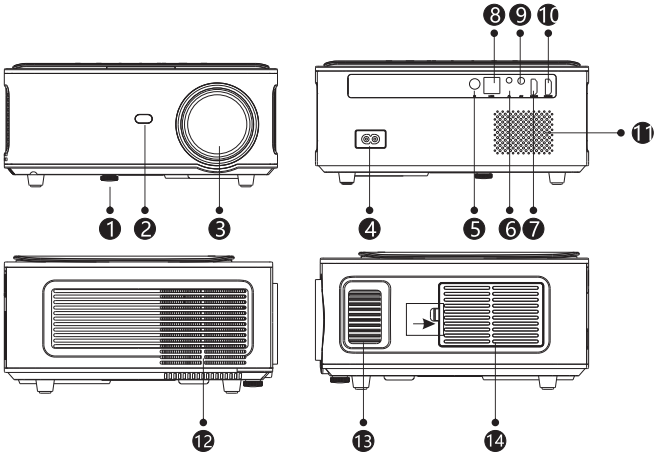

1. Adjustable Tilt Foot

2. IR Remote Sensor

3. Projection Lens

4. AC Input

5. IR Remote Sensor

6. 3.5mm Jack audio output

7. HDMI 1 port

8. USB port

9. AV port

10. HDMI2 port

11. Speaker

12. Ventilation Outlet

13. Focus Ring

14. Air Filter

PROJECTOR SCHEME

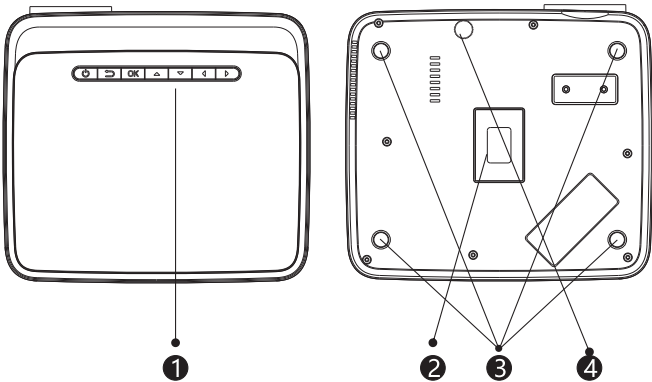

1. External Control Panel
2. Rating Label
3. Projector Mounting Holes
4. Adjustable Tilt Foot

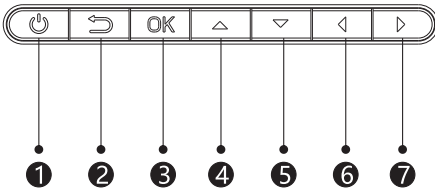

1. Power On
2. Exit Key
3. OK (Enter)
4. Up
5. Down
6. Left
7. Right

REMOTE CONTROL

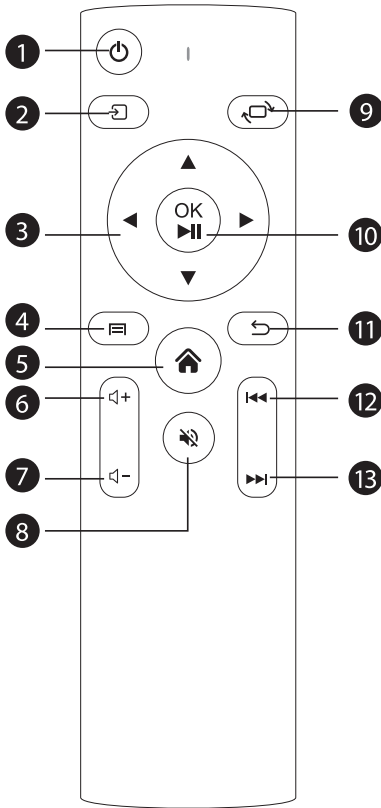

1. Power
2. Source
3. Direction Buttons
4. Menu
5. Home page
6. Volume +
7. Volume -
8. Mute
9. Flip
10. Direction Buttons (Play and Pause)
11. Return
12. Previous
13. Next

PROJECTOR INSTALLATION

Standard Setting

Please refer to the following table to adjust your picture size and distance (a projector's distance from the lens to the screen surface).

| Aspect ratio | 16:9 |
|---------------------|-------------------------|
| Picture size (inch) | Projection distance (m) |
| 50 | 1.70 |
| 70 | 2.38 |
| 100 | 3.30 |
| 120 | 3.97 |

Data provided in the table above may vary $\pm 3\%$. Setting the projector closer than the estimated min distance or the max distance exceeding may cause a result in a blurry image.

Warning:

Ensure that the projector is square to the screen. If the image is displayed as a trapezoid shape then refer to the diagram below for proper adjustment.

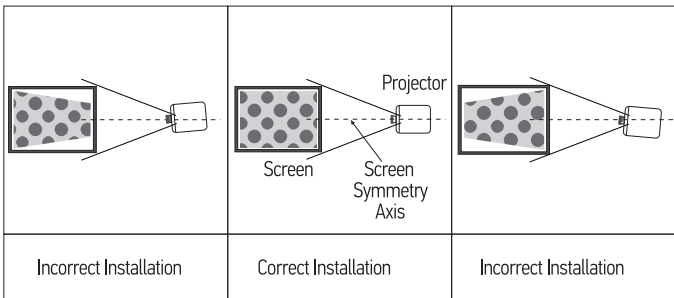

PROJECTOR INSTALLATION

Installation Method

Contact a professional installer for the projector ceiling mounting.

Please ensure that the screws used for ceiling mounting are of high quality and the length is enough to prevent the projector from falling.

Follow the instructions below to place the projector properly.

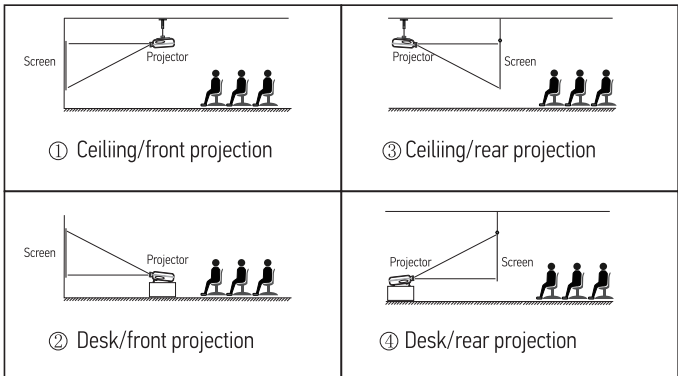

Warning:

1. The projector may be damaged beyond repair if it is incorrectly mounted on a ceiling or on a surface.
2. The recommended ambient temperature range is 41 °F - 95 °F. The incorrect temperature may lead to the device malfunction.
3. Please do not place the projector in wet, moist, or dusty conditions to prevent electric shock or malfunction.
4. Poor ventilation can be a significant cause of overheating. It could cause a projector to be damaged.

TURN THE PROJECTOR ON/OFF

The projector is in standby mode when it is connected to a power source. The indicator light turns red.

Turn ON: Press the "Power" key on the upper surface of the projector or the "Power" key on the remote control to turn it on. The indicator light turns blue.

Turn OFF: Press the "Power" key on the upper surface of the projector or the "Power" key on the remote control to turn it off. The indicator light turns red.

FOCUS ADJUSTMENT

FOCUSING

Make sure the projector is horizontal to the projector screen and rotate the focus ring to sharpen the projected image.

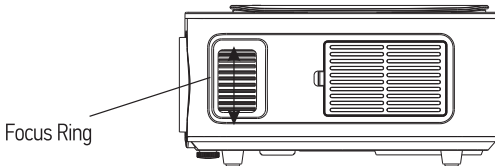

FOCUS RING

How to Select the Source

Press the "Menu" key on the remote control to enter the main menu. Select the source channel you need in the list on the left side of the main interface: HDMI 1 / HDMI 2 / AV. Press the "OK" key on the remote control to enter the corresponding source interface.

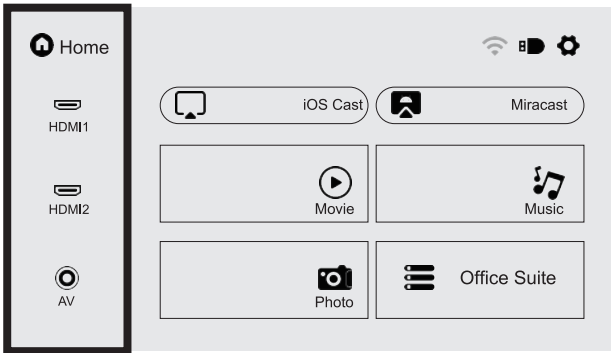

How to Connect to WiFi

Select the "Settings" icon in the upper-right corner of the main interface, press the "OK" key on the remote control to enter the settings interface, and select the "WiFi Setting" sub-menu. Select the WiFi you want to connect to in the list below. Enter the password to complete the connection.

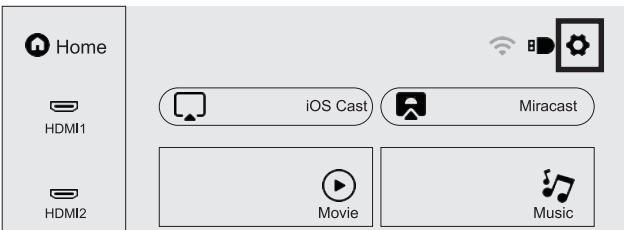

INTERFACE OPERATING INSTRUCTIONS

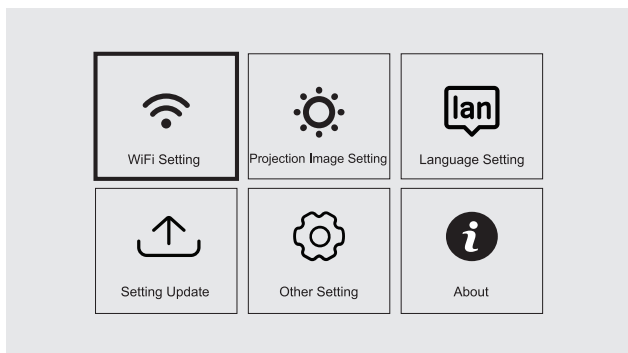

◀ WiFi Setting

WIFI ON/OFF



GZRIGAL-C

TP

BMW

This projector supports DLNA. When the projector connected to WiFi, smart devices in same network could play vedios on the project, which requires smart device APP supports DLNA.

INTERFACE OPERATING INSTRUCTIONS

How to Adjust the Projected Image

Select the "Settings" icon in the upper-right corner of the main interface, press the "OK" key on the remote control to enter the settings interface, and select the "Projection Image Setting" sub-menu.

Select the setting row you need.

Manual Keystone: 4-point Keystone

Projection mode: Front-Desktop / Rear-Desktop / Front-Ceiling / Rear-Ceiling

Digital Zoom: 50%-100%

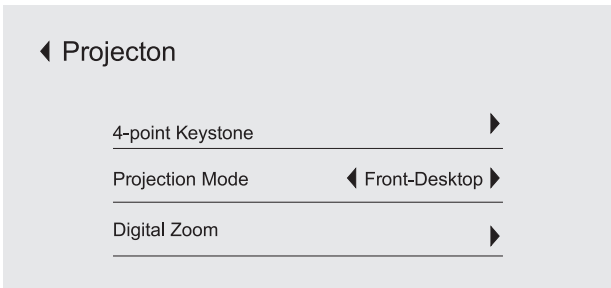
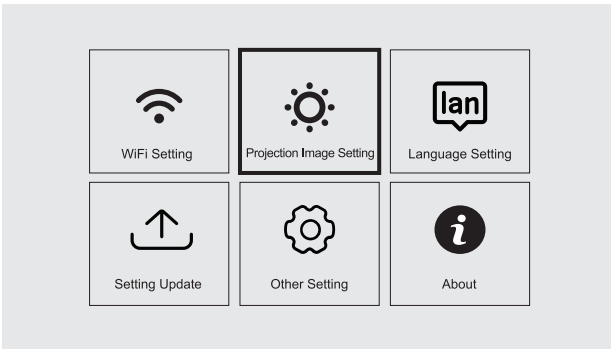

INTERFACE OPERATING INSTRUCTIONS

How to Use iOS Cast (Apple device)

Select "iOS Cast" in the main interface, press the "OK" key on the remote control to enter the setting interface.

Note: The projector should be connected to the Internet, otherwise the iOS Cast is not available. You need to upgrade the projector while using it for the first time.

1. The iOS device and the projector are connected to the same network;
2. Open the iOS device control center and select "Screen mirroring";
3. Choose the corresponding projector name.
4. Note, when iOS Cast is enabled on the projector, DLNA is disabled

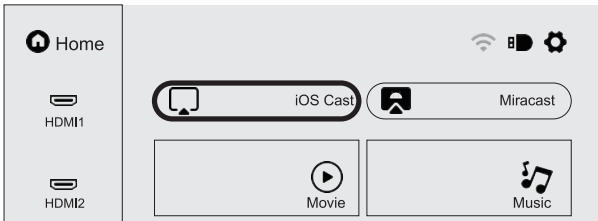

Make sure that your iOS device is connected to the same network as your Prjector

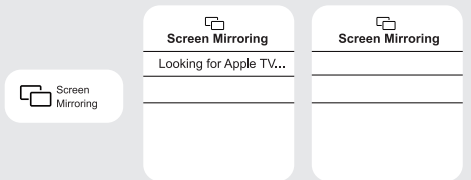

1. On your iOS device, open Control Center and tap Screen Mirroring.

2. Looking for devices that can be mirrored on.

3. Select DBPOWER-496d from the list

INTERFACE OPERATING INSTRUCTIONS

How to Use Miracast (Android device)

Select "Miracast" in the main interface, press the "OK" key on the remote control to enter the setting interface.

1. Connect the Android device to WiFi (the Android device and the projector are connected to the same network).
2. Turn the Android device "Wireless Display" function on.
3. Choose the corresponding projector name.
4. Note, when Miracast is enabled on the projector, DLNA is disabled

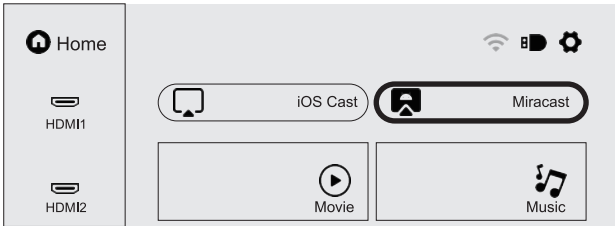

INTERFACE OPERATING INSTRUCTIONS

How to play media files from a USB Drive

Select the required category (Movie, Music, Photo, or Office Suite) in the main interface, and press the “OK” key on the remote control to enter the corresponding category.

Select the file you need and play it by pressing the “OK” key.

You cannot enter the required category if a USB Drive is not connected.

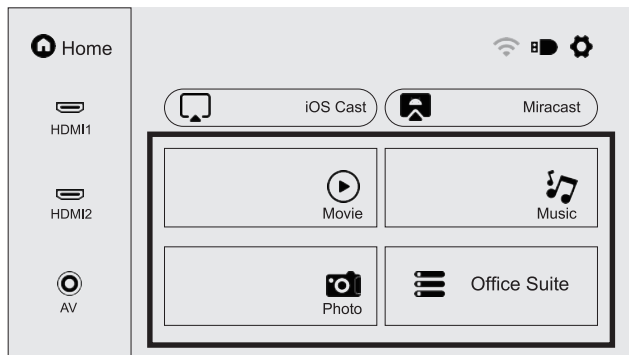

SUPPORTED MULTIMEDIA FILE FORMATS

Video Format: 3GP/AVI/FLV/MP4/MPG/VOB/TS/M2TS/DAT/MKV

Audio Format: MP3/APE/AAC/FLAC/OGG/WAV/WMA/MID/DTS/M4A

Image Format: BMP/JPG/PNG/JPEG



Supported multimedia file formats

TROUBLESHOOTING

| Problem | Possible Causes |
|--|---|
| 1. The indicator light does not work when the power switch is turned on. | ⊙ Prower cable is not connected properly |
| | ⊙ The power switch is faulty |
| 2. The projector cannot be controlled with the remote control | ⊙ The power switch is turned off |
| | ⊙ The remote control has no batteries, the batteries are low or installed not properly |
| | ⊙ The remote control is not being aimed at the IR receiver. |
| | ⊙ A strong light source shines into the IR receiver. |
| 3. No Image | ⊙ The input source is not correct |
| | ⊙ No input signal |
| | ⊙ The input cable is not connected |
| | ⊙ If a PC mode is set, the PC output frequency is incorrect (not correspond to 50-60Hz). Make sure the PC output is connected with the projector properly |
| | ⊙ Check if the laptop connected to the right output signal (HDMI1 or HDMI2) |
| 4. Shuts off unexpectedly | ⊙ The projector air vent is blocked |
| | ⊙ The voltage is not stable |
| | ⊙ The projector is overheating - check if the fan is not broken |

SPECIFICATIONS

Projection Technology: 5" LCD TFT display

Native Resolution: 1920x1080

Image Flip: 360°

Projection mode: Front-Desktop / Rear-Desktop /
Front-Ceiling / Rear-Ceiling

Lens: 5 Glass Lenses

Aspect Ratio: 16:9 & 4:3

Lamp Type: LED lamp, 50,000 hours lifespan

Image Size: 40-150 inch

Digital Zoom : 50%-100%

Working Voltage: AC100-240V/50-60Hz

Projector Size: 260×230×110mm

Net Weight: 2.2kg

DBPOWER



Learn more about DBPOWER, please visit us at:

www.dbpowershop.com

or

Scan QR Code & Start Chatting



FCC ID: 2AK43RD-828



Made in China

- m.me/DbpowerShop
- 1-855-888-5533
- support@dbpowershop.com
- www.dbpowershop.com