

DBPOWER

DJS50



## User Manual

Portable Car Jump Starter 800A 18000mAh

For petrol engines below 7.2L

and diesel engines below 5.5L

# ACTIVATE YOUR 12-MONTH WARRANTY & GET EXCLUSIVE GIFT

Register within 7 days after receiving your new product.

**PLEASE VISIT US NOW**

→ [warranty.dbpowershop.com](http://warranty.dbpowershop.com)

**CUSTOMER SERVICE**

✉ [support@dbpowershop.com](mailto:support@dbpowershop.com)

🌐 [www.dbpowershop.com](http://www.dbpowershop.com)



**NOTE**

1. DO NOT start any engines that exceed the maximum displacement the jump starter can bear.
2. DO NOT crank the engine for more than 3 seconds.
3. Allow the jump starter to cool down for at least 1 minute between each start attempt.
4. Please ensure the device is at least 50% charged before use.

## A Big Thank You

We're thrilled that you have chosen to purchase the DBPOWER jump starter. At DBPOWER, we're committed to providing you with products that enhance your daily life. We also aim to give our customers excellent support. Should you have any questions or feedback about your new product, simply get in touch with our customer support team at 1-855-888-5533, or by email at [support@dbpowershop.com](mailto:support@dbpowershop.com)

Enjoy your new product!

## ATTENTION

1. This device is suitable for petrol engines up to **7.2L** and diesel engines up to **5.5L**. To avoid damage to the device and potential injury, do not attempt to start an engine exceeding this capacity.
2. Don't crank the engine for more than **3 seconds**. Allow the jump starter to cool down for at least **1 minute** after each 3-second start attempt.
3. Your jump starter will work best when it is fully charged. If it is less **than 50% charged**, it will have insufficient charge to start the engine.
4. Clear the your car battery's electrodes of dust and debris before jump starting.
5. If the instructions are followed correctly but your vehicle still doesn't start, please wait for **5-10 minutes** and try again. Do not make repeated attempts to jump start the engine without allowing time for the device to cool down.
6. Do not connect the positive and negative polarity clamps together when the device is powered on.
7. Disconnect the cables from the jump starter when not in use.
8. Do not charge the device immediately after jump-starting your vehicle. Wait at least **30 minutes** before charging the device after a jump start.
9. To preserve longevity, discharge and recharge the device at least once every 3 months.
10. Use the provided or certified cables.
11. Do not expose the jump starter to liquids. Do not disassemble.
12. Avoid dropping the device and exposing it to extreme temperatures.

## ACCESSORIES



1 x Intelligent Jumper Clamps



1 x Car Cigarette Lighter



1 x Laptop Charge Cable



1 x 8-in-1 Connector

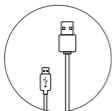

1 x USB Line

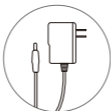

1 x Adapter









1 x User Manual



1 x Semi-Hard Case

## SPECIFICATIONS

 Capacity	18000mAh/ 66.6Wh
 Weight	619g/ 21.8oz
 Size	185x 85 x 38mm/7.3x 3.4 x 1.5 inches
 DC Input	DC 15V/1A
 USB Output	5V/2.1A; Smart 5V/2.4A
 DC Output	12V/3.5A (16V/3.5A; 19V/3.5A)
Jump Starter Peak Output	800A
Jump Starter Output	400A
Operating Temperature Range	-20°C- 60°C/ -4°F- 140°F

## AT A GLANCE

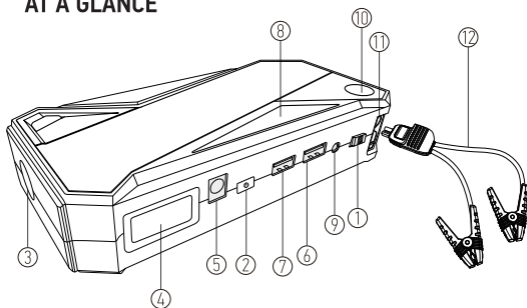

- |                       |                           |
|-----------------------|---------------------------|
| 1. ON/ OFF Button     | 7. 5V/2.4A USB Output     |
| 2. Function Key       | 8. Red Emergency Light    |
| 3. LED Flashlight     | 9. 15V/1A DC Input Port   |
| 4. LCD Screen         | 10. Compass               |
| 5. Output Port        | 11. 12V/400A Jumping Port |
| 6. 5V/2.1A USB Output | 12. Jumper Clamps         |

## HOW TO JUMP START YOUR CAR

1. Turn on your jump starter and ensure it has a charge of over 50%. (Charge fully before initial use)

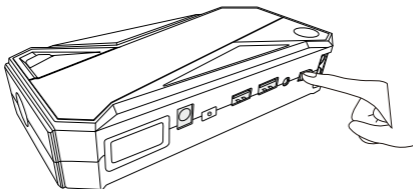

2. Insert jumper cables into jumping port. The indicator light is flashing green.

When the red light is continuously on and the buzzer sounds every second, then the device needs to be charged before it can be used.

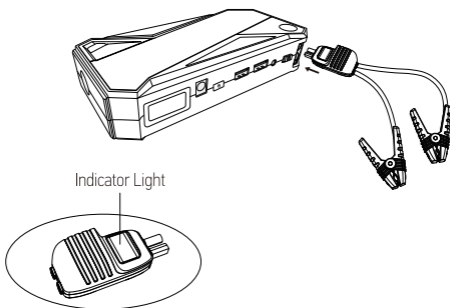

3. Connect the red clamp to the positive(+) terminal and the black clamp to the negative(-) terminal of the car battery. The indicator light will change from green flashing light to continuously on. **Note: In order to eliminate connection errors and ensure safety, the clamps will detect the load every 5 seconds and give a warning tone. This does not affect the jump start. In addition, the clamps will disconnect automatically after 30 seconds and red lights will stay on with no sound emitted. Please attempt to start the engine within 30 seconds. If you need to attempt to jump start the engine again after 30 seconds, please remove and reconnect the clamps, then try again. For specific precautions regarding use of the clamps, please refer to the "Exception Description Indicated by The Clamps" section.**

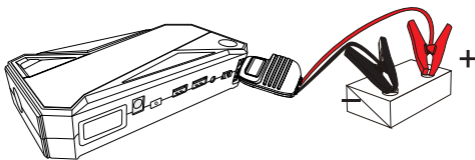

4. Start your engine.
5. Remove clamps and pack away.

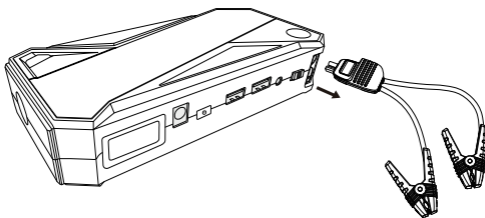

## HOW TO CHARGE CELLPHONES OR TABLETS

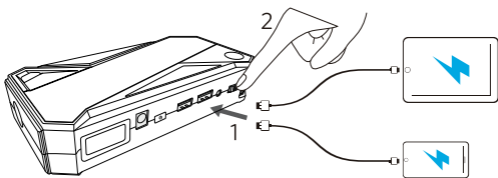

## HOW TO CHARGE LAPTOPS

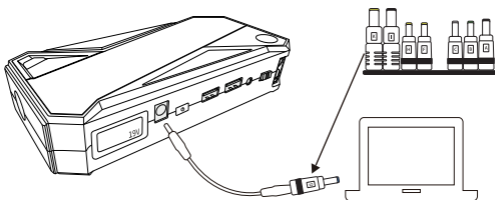

1. Turn on the device and press the power button to cycle between voltages 12V/ 16V/ 19V according to the laptop voltage (19V in most case).
2. Choose a suitable connector, connect it to the laptop charging cable.
3. Connect your laptop to the jump starter via the cable.

## HOW TO USE THE LED FLASHLIGHT

1. Hold to turn on/off.

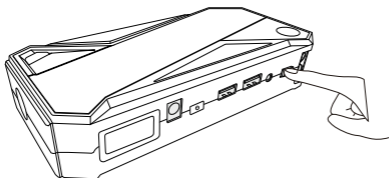

2. Press and hold the power button for 2 secs to turn on the LED flashlight. Short-press to switch modes (high/SOS/strobe). Press and hold for 2 secs again to turn it off.



## HOW TO RECHARGE THE DEVICE

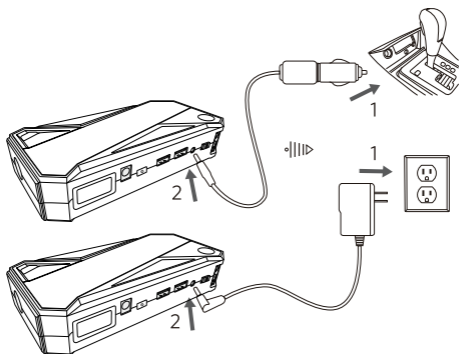

Note: Please switch the jump starter to "OFF" when not in use to preserve battery life and prevent over-discharge.

## EXCEPTION DESCRIPTION INDICATED BY THE CLAMPS

### Normal standby indicator

When the green light flashes, the emergency power supply can start the car.

### Operating instructions

When the green light is on, it indicates the car can be started.

### Low voltage protection

When the red light is continuously on and the buzzer sounds once every second, the emergency power supply is insufficient, and the device needs to be fully charged before attempting to start the vehicle.

### Reverse polarity protection

When the red light is continuously on and the buzzer makes a constant sound, the positive and negative clamps have been connected incorrectly to the car battery. Connect the clamps in the correct way and try again.

### **High temperature protection**

When the red lights flashes and the buzzer sounds once every second, the high-temperature protection feature has been activated. Please allow some time for the device's temperature to lower before using again.

### **Short-circuit protection**

When the red light is continuously on and the buzzer makes a constant sound, the positive and negative clamps are in contact with each other. Adjust the clamps so that they are not in contact with each other, and then try again.

### **Jump starter timeout protection**

When the red lights are continuously on with no sound from the buzzer, the maximum operating time of the jump starter (30 secs) has been reached. To make another jump start attempt, release the clamps first and then try again.

### **Reverse charging protection**

When red and green lights flash alternately, reverse charging protection has been activated. This function is to protect the emergency power supply and to avoid damage to it caused by incorrect charging.

### **High-voltage protection**

If the red light is continuously on and the buzzer makes long beeping sound, the power supply ignition voltage limit has been exceeded. It is necessary to discharge the power supply before performing an ignition operation.

### **Start-up overrun protection**

If the red lights are continuously on , it means the battery voltage of the device is too low, and the device needs to be fully charged before performing an ignition operation.

## EU DECLARATION OF CONFORMITY (DOC)

Product: Portable Car Jump Starter

Model/Type: DJS50

Serial No.: N/A

EU Based importer: LEAPING HERO LIMITED

Address: 35 IVOR PLACE LOWER GROUND LONDON ENGLAND NW1 6EA

This declaration is issued under the sole responsibility of the EU based importer.

The object of the declaration described above is in conformity with the relevant Union harmonisation legislation:

2014/35/EU The Low Voltage Directive

2014/30/EU The Electromagnetic Compatibility Directive 2

011/65/EU The Restriction of hazardous Substances Directive

Conformity is shown by compliance with the applicable requirements of the following documents:

**The Low Voltage Directive:**

EN 60950-1:2006+A11:2009+A1:2010+A12:2011+A2:2013

The Electromagnetic Compatibility Directive:

EN 55032:2015; EN 55024: 2010; EN 61000-3-2:2014;

EN 61000-3-3:2013

**The Restriction of hazardous Substances Directive:**

IEC 62321-3-1:2013; IEC 62321-5:2013; IEC 62321-4:2013; IEC 62321-6:2015

Signed for and on behalf of: LEAPING HERO LIMITED

Place of issue: Suffolk

Data of issue: 6th August 2019

Name: Dennis Clarke

Position: Technical Director

Signature:



 **24/7 LIVE CHAT  
SUPPORT**

To learn more about **DBPOWER**,  
please visit us at:

[www.dbpowershop.com](http://www.dbpowershop.com)

or

Scan QR Code & Start Chatting



**RoHS**  
COMPLIANT

CE

FC



Made in China



[m.me/DBPowerShop](https://m.me/DBPowerShop)



1-855-888-5533



[support@dbpowershop.com](mailto:support@dbpowershop.com)



[www.dbpowershop.com](http://www.dbpowershop.com)