

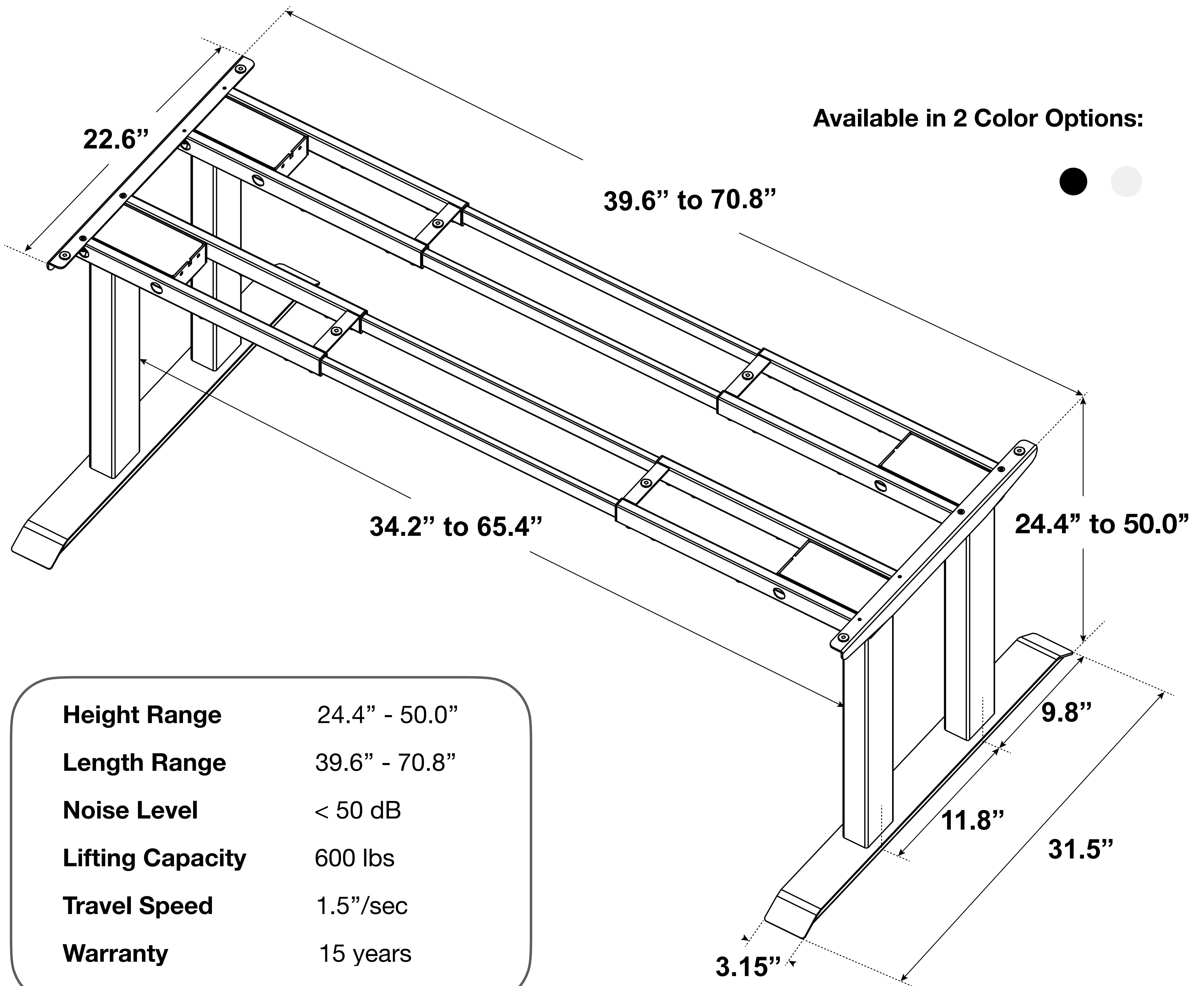

VORII ELEMENTDESK SUPER V3.0 FRAME SPECIFICATIONS

SKU: L-XOT-S-800 -Black/White

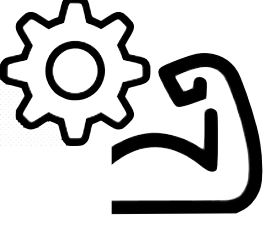
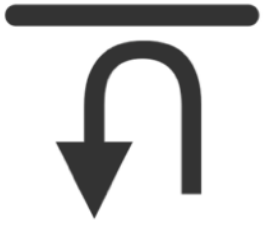
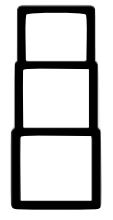
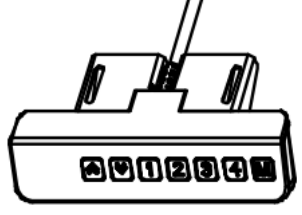
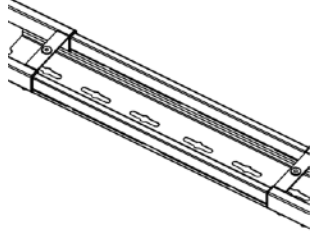
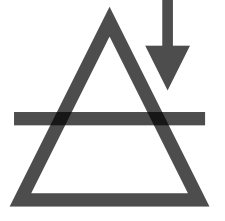

Height Range	24.4" - 50.0"
Length Range	39.6" - 70.8"
Noise Level	< 50 dB
Lifting Capacity	600 lbs
Travel Speed	1.5"/sec
Warranty	15 years

	Four Motors Design		Gyroscope Anti-Collision System with 3 Sensitivity Settings
	Heavy Duty 3-Stage SPCC Steel Leg x4		Four Customizable Height Presets
	Included Under-Desk Wire Management Cover		Motor Locking Mechanism Protects Desk from Uneven Weight Distribution
	35000 Up and Down Cycles Durability Test		FCC / UL / TUV / ISO9001 / CE / ROHS Certificated

