

# ***SPLASHDRONE 3+***

## *User Manual (New Zealand)*

V22.03.19

**FOR BELOW NZ MODELS ONLY..**

**FISHERMAN**

**PRO**

**PROFISH**



**W: [www.splashdrone.co.nz](http://www.splashdrone.co.nz)**  
**PH: 094433758**



Join our facebook group "Splashdrone NZ" for  
product updates and support.

Thank you for purchasing the SwellPro SplashDrone3+. We have designed and manufactured the SplashDrone to the highest quality standards. This New Zealand version has been tuned and tested for New Zealand Conditions.

It is important to familiarize yourself with the features of this unique drone by carefully studying this manual and included support document and particularly the priority sections indicated in the Table of Contents. Please Note: Check [www.splashdrone.co.nz](http://www.splashdrone.co.nz) for the latest manuals, software and tips. Refer to the Version Information section at the end of this manual which details additions and corrections to this manual.

For support, please call 094433758 or email: [sales@jcmatthew.co.nz](mailto:sales@jcmatthew.co.nz)

## Reading Notes

### Icons Used in This Manual



Read first



Prohibited



Important Notice



Operating Tip

### Other Information

Visit and subscribe to **JCMATTHEW's** YouTube channel for instructional videos and product information.



Only watch JCMATTHEW Calibration videos to setup your drone.



<https://www.facebook.com/splashdroneNZ/>

[https://www.youtube.com/channel/  
UCFV157QErex1vyf9Myul-5w](https://www.youtube.com/channel/UCFV157QErex1vyf9Myul-5w)

# Contents

<b>Reading Notes</b>	02
Icons Used in This Manual	02
Other Information	02
Register your Product Warranty	02
<b>Product Overview</b> 	05
The SplashDrone 3+	06
Drone Components	07
Remote Controller Components	08
Remote Controller Screen controls	09
FPV Screen Interface	10
Drone Indication Lights	11
Drone Landing Gear	12
Propellers	13
Batteries	14
<b>Flight Modes</b> 	15
Flight Modes	16
Return Home	17
<b>Preparing for Flight</b> 	18
Preparing for Flight	19
Preparation before your First Flight (or in a new location)	19
Accelerometer (Gyroscope) calibration	19
Compass Calibration	21
Preparation Before Every Flight	24
<b>Remote Controller</b>	25
Remote Controller Overview	26
Low Battery Alarm Warnings	28

<b>Flight</b> 	29
Introducing You to Flying a Drone	30
Flying the SplashDrone 3+	30
Default Flight Restrictions	30
Starting / Stopping the Motors	31
Basic Flight Steps	32
Water Take-offs and Landings	33
Power-Flip	33
Take-offs and Landings from a Boat	34
<b>Advanced Settings</b>	35
Video Transmitter Channel Selection	36
Remote Controller Pairing (to the drone)	37
Conversion of the Remote Controller Throttle Position	38
Remote Controller Joystick Calibration	39
<b>Appendix</b>	40
Specifications	41
Warranty Information	42
FLIGHT BATTERY -Safety Guideline	42
Safety Operation Guideline & Disclaimer and Warning	45
Safe Operation Guidelines	45
Disclaimer and Warning	48
Version Information	50

## Product Overview

---



This section identifies the different parts of the drone, controller and accessories and describes how to assemble the drone.

Enhancing and extending the features of the previous SplashDrone 3, the latest SplashDrone 3+ provides enhanced features.

Coupled with several different payload accessories such as cameras, low-light sensors or release mechanisms, your SplashDrone 3+ can be adapted for a wide variety of uses. It is an all-purpose, all-weather flying platform.

The SplashDrone 3+ allows you to operate in most weather conditions, in tough environments, whether over land or over the sea. With its advanced modular design it can quickly adapt to all type of missions from aerial filming to search and rescue, ocean survey, fishing and many more applications. **If you encounter any anomaly while setting up, calibrating or flying your drone, please contact us asap. You can ring us on 094433758 on weekdays 9-5 or email us on: sales@jcmatthew.co.nz**

## Drone Components

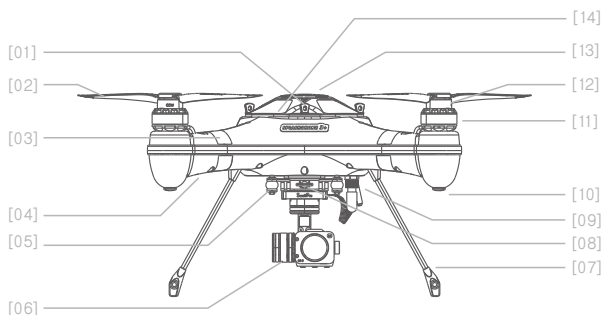

[01] Cover/hatch screw

[02] Quick release carbon fiber propellers

[03] Nose direction markers

[04] Flight Indication Lights - Front: 2 X Green LED

Stern: Tri-colour Drone Status Lights

[05] Antenna pod

[06] Payload accessory space (camera illustrated)

[07] Landing gear

[08] Accessory quick-release screw

[09] Cable plug/socket

[10] Rubber foot

[11] Brushless motor

[12] Propeller Attachment system

[13] GPS top cover/hatch

[14] Drone Status Light visible

through top cover

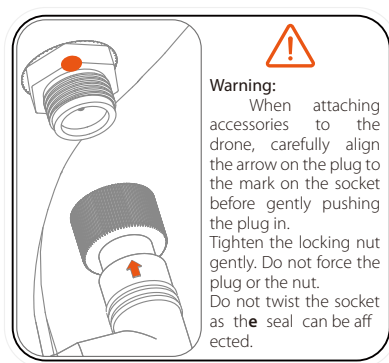

## Remote Controller Components

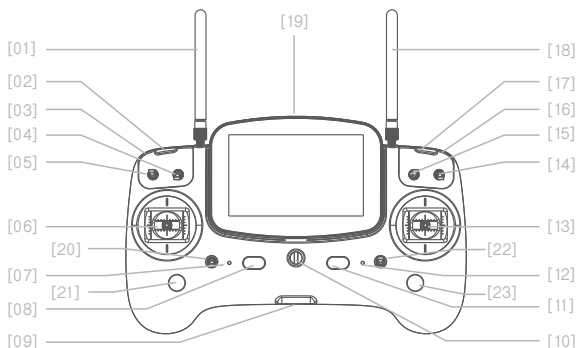

- |   |  |  |
|---|--|--|
| [01] Remote Antenna<br>For drone control signal<br>2.4GHz   | [10] Hanger ring<br>Attachment point for neck<br>lanyard   | [19] FPV screen<br>Displays FPV live video and<br>On Screen Data (OSD) from<br>the drone.                    |
| [02] Left pairing button<br>For binding the RC with<br>the drone  | [11] Right power button<br>Press the left and right power<br>buttons simultaneously to<br>power on the controller. | [20] Smooth+ Yaw switch<br>Activates the Smooth+<br>Yaw control  |
| [03] Accessory Control<br>Wheel<br>Function depends on the<br>accessory used  | [12] Power status Indicator<br>Displays the remote<br>controller's battery status                                  | [21] Smooth+ Yaw control<br>Fine control of drone<br>rotation (yaw) when<br>Smooth+ yaw is active            |
| [04] Camera switch<br>Used for controlling Video<br>and Photo functions.  | [13] Right joystick<br>Controls the drone direction<br>of flight   | [22] Smooth+ Pan switch<br>Activates the Smooth+<br>Yaw control  |
| [05] Airdrop switch<br>Opens and closes the payload<br>release  | [14] Return-Home switch<br>Commands the drone to<br>return automatically   | [23] Smooth+ Pan control<br>Fine control of lateral<br>drone movement (pan)<br>when Smooth+ Pan is<br>active |
| [06] Left Joystick<br>Controls the drone's ascent<br>(up), descent (down) and/or<br>to rotate the aircraft nose<br>left or right (Yaw). | [15] Flight mode switch<br>GPS / Cruise Flight / ATTI  |  |
| [07] Working Status Indicator<br>Remote controller status   | [16] Gimbal Vertical Tilt<br>wheel<br>Adjusts the vertical tilt of<br>the camera                                   |  |
| [08] Left power button<br>Press the left and right<br>power buttons<br>simultaneously to<br>power on the controller                     | [17] Right pairing button<br>For binding the RC with<br>the drone  |  |
| [09] USB Port /Interface<br>For remote controller firmware<br>upgrade   | [18] Video antenna<br>Receives FPV live video<br>5.8GHz  |  |



## Remote Controller Screen Controls

### Power Button

The screen will automatically power on with the remote controller, but can be manually powered off.

### Auto search/Menu Select

Use the auto search function to select the most suitable channel / Switch between the different menus

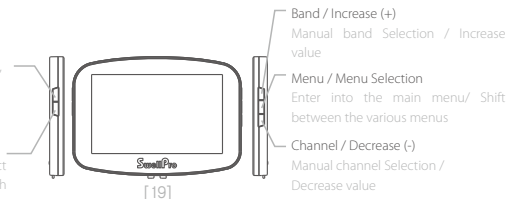

The FPV screen of the Remote Controller provides realtime flight information as well as images from the drone if a camera accessory is fitted. The SplashDrone 3+ uses 5.8GHz video transmission technology to reduce transmission delays to a minimum. The 5.8G range can reach max 500m (depending on conditions) and has 40 channels available to select from. The live feed distance can be extended with the help of third party high gain and higher decibel antennas. See the Advanced Settings section of this manual for more details.

**⚠ Before turning on the Remote Controller, ensure all switches are in their uppermost (top) position or the Remote Controller will not complete its power up-sequence and will sound a constant alarm.**

## Remote Controller LED Indicators

Working Status Indicator	Power Status Indicator	Warning Tone	
Solid Green	Solid Green		Status is good
	RED Light ON	No	Remote Controller battery low
	RED slow flash	Yes	Remote Controller battery is dangerously low
Slow Flash		Yes - once	Remote controller and drone receiver disconnected
Fast Flash		Success tone	Pairing

**⚠ When the remote controller battery level becomes very low, the remote controller power status light will slowly flash red and sound a warning tone. If this occurs, please land the drone as soon as possible. If the Remote Controller loses power during flight, the drone will automatically return to its home point and land.**

## FPV Screen Interface

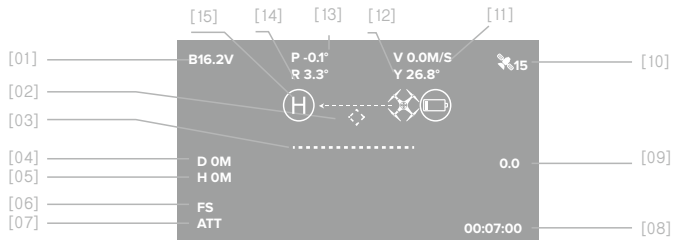

- [01] **Battery Voltage**  
Drone battery voltage
- [02] **Return Home direction** <←>  
Dynamically displays the relative angle between the nose and the return point. When the mark is displayed in middle of the FPV screen, it means the nose of the drone is facing the return point.
- [03] **Artificial Horizon**  
Displays the angle of roll of the drone
- [04] **Distance**  
The horizontal distance between the drone and the home point.
- [05] **Height**  
The vertical height of the drone above the home point elevation
- [06] **Flight Safety Warning**  
FS is displayed when the drone is automatically landing for low battery or other safety issues
- [07] **Flight Mode**  
GPS: GPS Mode  
ATT: ATTI Mode  
CIR: Smart Cruise
- [08] **Time**  
Flight time since last motor start
- [09] **Ascent speed** ↑ **Descent speed** ↓  
The vertical speed of the drone when ascending or descending, units are metres/second
- [10] **GPS reception**  
Number of GPS/GLONASS satellites being used for positioning
- [11] **Velocity**  
The drone's current horizontal speed
- [12] **Yaw Compass angle**  
The compass heading of the drone
- [13] **Roll**  
The drone's current angle of roll
- [14] **Pitch**  
The drone's current angle of nose pitch
- [15] **LOW Battery warning**  
Visual warning to return the drone as battery voltage is low. This symbol will start flashing if battery voltage becomes critical and the drone will start auto landing in place.

## Drone Indication Lights

The fuselage of the drone includes a pair of green nose LED indicator lights and a pair of status indicator lights on the rear arms.



The nose LED indicator lights are always lit and are used to indicate the direction of the nose of the drone. The rear aircraft status lights indicate the current status of the flight control system by flashing patterns of red, green and yellow lights.

Please refer to the following table for the different messages.

### Drone Status Indicators (REAR EXTERNAL LIGHTS & INTERNAL LED)

#### Flight Modes (First set of flashes)

●	One Green Flash	ATTI Mode
● ●	Two Green Flashes	GPS Mode
● ● ●	Three Green Flashes	Circling flight & Smart Cruise (Optional)
● ● ● ●	Four Green Flashes	Cruise Flight
● ● ● ● ●	Green Fast Flashing	APP control/ Return Home







#### GPS Status (Second set of flashes)

○	No Red light	Good GPS signal
●	One Red Flash	Satisfactory GPS signal
● ●	Two Red Flashes	Poor GPS signal
● ● ●	Three Red Flashes	No GPS connection, or no GPS signal

#### Low battery warnings

● ● ●	Three Yellow Flashes	First level low battery warning, for safety, land as soon as possible.
● ● ● ● ● ●	Yellow Fast Flashing	Second level low battery warning, the drone will start it's auto landing sequence.

## Warnings and Abnormal Status

	Red - Fast Flashing	Lost radio signal
	Yellow, Green alternate slow flashing	Compass interference detected
	Alternating Red & Green slow flashing	Lost GPS signal, GPS abnormal
	Alternating Red and Yellow - slow flashing	IMU (accelerometer) vibration has exceeded its limits, or is abnormal
<b>Other</b>		
	Red, Green, Yellow alternate flashing	Initialization process after powering on
	Red solid ON	Motors cannot be armed

Some additional flashing patterns are used for special conditions such as calibration.

## Drone Landing Gear

The SplashDrone 3+ has two carbon fibre landing frames that raise the drone and propellers above most ground obstacles and also protect any accessories mounted under the drone body.

Each landing gear frame is installed by inserting one leg at a time. Push one leg firmly all the way into the socket. Then insert the second leg of the frame into its socket, applying slight pressure against the first leg to align the second leg with its socket. Make sure the legs are fully inserted into the sockets. The legs are held in place by the flexing pressure of the legs.

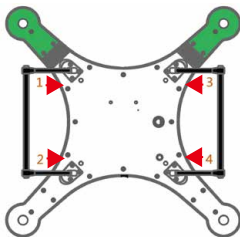

Insert the landing gear one leg at a time, according to the red arrows. Ensure the legs are fully inserted.

## Propellers

The SplashDrone 3+ has two pairs of propellers - two clockwise propellers and two counter-clockwise propellers. The hub of each motor shows the type of propeller used for that motor. Propellers cannot be attached to the wrong motor by accident.

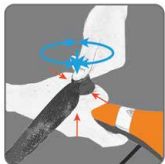
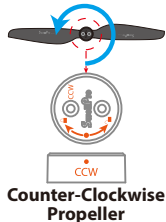
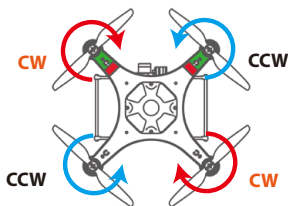
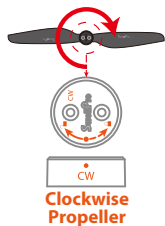

- ⚠ When installing or removing the propellers, place one hand under the motor to support it when installing or removing propellers. Failure to provide this support could result in bending or breaking the landing gear.

### Attaching and Removing Propellers:

1. Check that the propeller rotation (CW or CCW) matches the motor hub. This is the normal direction the propellers spin during flight.
2. Rotate the propeller in the hub until it engages, then push the propeller downwards and rotate it 1/8th of a turn opposite to its name to lock it.
3. Check the propeller is completely locked by checking that the dots on the propeller and hub align or by holding to motor hub firmly and ensuring that the propeller cannot be turned.
4. To remove propellers, support the motor with one hand and press the propeller down and then rotate it 1/8th of a turn according to its name to unlock it from the hub.

⚠ The blades are sharp, please be careful to avoid accidental cutting or scratches.

⚠ Prior to each flight, please check that the propellers are smooth all over and are correctly installed and securely fastened.

The SplashDrone 3+ has two batteries required for operation. One battery powers the drone, the other powers the drone remote controller.

It is important to charge the batteries fully before use and install them correctly.

### Drone Battery Installation

When inserting the battery, observe the following precautions:

- Hold the battery velcro and drone power cable out of the way as the battery is inserted.
- Insert the battery with care with its cables on the left-hand side of the drone.
- Observe the label on the battery
- Please observe the instructions and the arrow on the label.



**⚠ Once connected to the drone, the battery cables and connectors must be placed & tucked away in the space between the battery and the rear case of the drone.**

### Remote Controller Battery Installation

The Remote Controller battery is located behind a hatch on the back-side of the unit.

To open the hatch, apply slight downward pressure to the hatch and slide it open.

When installing the battery, be careful to align the battery connectors properly. Incorrectly connecting the battery will damage the remote controller and void the warranty.

Close the battery hatch by aligning the hatch and sliding it closed.

### Low temperature precautions

1. In low temperature environments (-10C degrees to 5C degrees) , flight time will be reduced. Ensure batteries are fully charged and kept warm (20~30C) before use.
2. Also be aware that the low battery warnings will provide less warning time, so land the drone as soon as the first battery warning appears.

## Flight Modes

---



This section introduces the drone and its functions.

## Flight Modes

The SplashDrone 3+ utilizes an improved flight control system, incorporating 3 of the best flight modes.

**GPS mode:** This mode uses the GPS module to achieve accurate and stabilized hovering, braking, intelligent flight, intelligent return and other intelligent flight mode functions. In this mode, maximum flight speed is 10m/s, maximum ascend speed is 4m/s, and maximum descend speed is 3m/s. **Please leave in the GPS mode if you're a beginner flyer.**

**Smart Cruise:** Specially designed for smooth aerial filming. The turning function of the left joystick is disabled, and is blended into the right joystick function, to achieve smooth sweeping turns with a single control.

**ATTI mode:** This is a more advanced flight mode which does not use the GPS positioning function but still maintains altitude stabilization. The drone will drift with any wind when hovering and will not brake when the joysticks are released.

---

 In both ATTI and GPS mode, it is recommended to wait for at least **13** GPS satellites before take-off to ensure that the home point is correctly registered for the Return Home function to operate.

 In ATTI mode the drone's speed is faster and auto braking is disabled. Ensure the drone has sufficient space for the pilot to turn or brake. For emergency braking, with sufficient GPS coverage in ATTI mode, switch to GPS mode and release the joysticks.

 Select the preferred flight mode of the drone using the remote **flight** mode switch on the controller.



---

## Return Home

The SplashDrone 3+ has an Auto Return Home function if the GPS successfully recorded the home point before takeoff. If the remote controller and the aircraft lose communication with each other, the drone will automatically return to the take off point and land. The Return Home function can also be manually initiated from the remote controller by using the Return Home switch.



## Return Home Process

Flare maneuver	Description
	If the drone's height > 20 Metres* and distance from Home Point > 15 Metres, the drone will maintain its altitude and return to its Home Point.
	If the drone's height < 20 Metres* and distance from Home Point > 15metres, the drone will climb to 20 Metres* and then return to its Home Point.
	If the drone's height < 10 Metres and distance from Home Point < 15 Metres, the drone will maintain its altitude and return to its Home Point.

⚠ If the GPS signal is poor (fewer than 5 satellites) or GPS doesn't work, the Return Home function will not be available. **OR the Return Home function will not work as intended.**

\*The Return Home altitude default is 20 Meters, but can be changed to another altitude by using the SwellPro Assistant software.

⚠ Note: During the return process, only the right (steering) stick is active. When the drone returns to the Home Point and commences its descent, the left joystick will only control the direction (Heading) of the drone, the right joystick controls the forward/back and sideways functions to fine-tune the landing site.

At any point, the return home function can be cancelled by returning the Return Home switch to the Normal position.

**Note: If the Return Home feature does not work as intended. Please take the drone out of "Return Home" immediately, switch the flight mode switch to ATTI & fly the drone home manually.**

## Preparing for Flight

---

This section describes how to prepare your drone for flight.

## 1st Preparing for Flight

Before every flight, it is important to prepare your drone properly.

### 1st Preparation Before your First Flight (or in a new location)

The drone relies on very sensitive sensors to control flight positioning and stability. The accelerometer (gyroscope) and compass sensors need to be calibrated before every flight.

### 1st Accelerometer (Gyroscope) Calibration

Accelerometer calibration should be done before each flight but is especially important when:

- a. The drone is brand new.
- b. The drone has been flown extensively in ATTI mode.
- c. When in GPS flight mode and using only the THROTTLE joystick, the drone drifts at an angle.
- d. The drone has been subjected to heavy shaking during transportation.
- e. If after successfully performing a compass calibration, the drone Status indicators are solid red when trying to arm (unlock) the motors.

## Accelerometer Calibration Process

1. Place the drone on a horizontal **flat & level** surface. Power on the remote controller then the drone.
2. After hearing a drone power up tone, switch to "Return-Home" mode on the controller.
3. Hold the **left joystick into the lower right corner\***(45°) and the **right joystick into the upper right corner\***(45°) position.

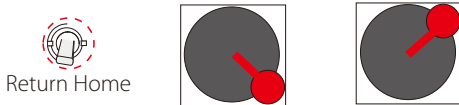

Switch and Joystick commands for Accelerometer Calibration\*

4. The Drone Status Lights will start fast blinking red-green-yellow indicating that calibration is underway. When the Status lights go solid green, release the joysticks to complete the calibration.

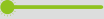
	Red, Green, Yellow fast flashing	Calibrating Accelerometer
	Green ON	Calibration Successful release the joysticks

## Compass Calibration

Please refer to the status indicator light for compass calibration. Calibration notes are as follows:

Please Note: **It is recommended to calibrate the compass at the proposed flying area before flying.** Flying anywhere close to any magnetic interference is HIGHLY DISCOURAGED. (Please make sure to keep far away from the following: High-Voltage transmission power lines, Emitting base stations, metal objects, etc.)

DO NOT CALIBRATE CLOSE TO VEHICLES, ENSURE YOUR PHONE & KEYS ARE NOT ON YOUR BODY & YOUR PHONE WIFI & BLUETOOTH HAVE BEEN TURNED OFF.

Calibration Processes is necessary in below cases:

1. Before flying drone for the first time.
2. Every time you fly your drone.
3. Especially if The drone has been crashed/dropped by accident.
4. Especially if The drone keeps swaying / drifting during flight.
5. Especially If the drone has incurred or was subjected to a heavy shaking during transportation.
6. Especially If the RED light stays on, and the motors can't be unlocked.  
Please ensure you perform the six surface calibration, (of a cube) - as described below for high accuracy.

IMPORTANT!!: PLEASE REFER TO THE YOUTUBE CHANNEL: "JCMATTHEW" FOR A DETAILED VIDEO ON TUTORIAL FOR HOW TO CORRECTLY PERFORM THE CALIBRATION. DO NOT TAKE INSTRUCTION FROM ANY OTHER THIRD-PARTY VIDEO.

IMPORTANT!!: NEVER ATTEMPT TO CALIBRATE WITH PROPELLERS ON - AS THIS REPRESENTS A SAFETY HAZARD.

---





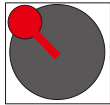

## Complete Six-Sided Calibration Process

Compass Calibration is performed with the drone outdoors and away from any sources of magnetic interference such as metal structures, radio masts or mobile phones.

1. Place the drone on a horizontal surface. Power on the controller then the drone.
2. After hearing a drone power up tone, switch to "Return-Home" mode on the controller.
3. Hold the left joystick into the lower left corner\*(45°) and the right joystick into the upper left corner\*(45°) position. The Drone Status Indicators will fast-flash Red-Green-Yellow.

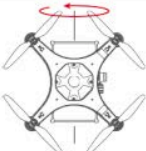

**Switch and Joystick commands for Complete Compass Calibration\***

Operation Illustration	Description
	<p>1. Place the drone on a horizontal surface, power on the controller, and then power on the drone. Wait for the self-check sequence to finish (red/green fast flash). After "DI" sounds, flick the return home switch to Return Home.</p>
	<p>2. Pull the left joystick to the lower left corner (45 degrees), the right joystick to the upper left corner (45 degrees), maintain this gesture for 2 seconds, RED/GREEN/YELLOW Lights will flash meaning the drone has entered compass calibration mode. We will refer to the face of a clock of positional reference -12 -3 -6 -9.</p>
	<p>3. In the horizontal plane, while holding the drone firmly in front of you, rotate your body counter clockwise for 360 degrees making sure the drone remains on a flat &amp; even plane throughout.</p>
	<p>4. Now, invert the drone, and repeat the counter clockwise motion of your body, making sure the drone remains on a flat plane</p>
	<p>5. Swing the drone vertically, nose up (12midday), and perform a counter clockwise rotation of your body for 360 degrees as above, making sure the drone remains on a flat plane.</p>
	<p>6. Whilst vertical, turn the drone so the nose is to the left (3 o'clock), and perform a counter clockwise rotation of your body for 360 degrees making sure the drone remains on a flat plane.</p>
	<p>7. Whilst vertical, turn the drone such its nose is pointing down (6 o'clock), and perform a counter clockwise rotation of your body for 360 degrees making sure the drone remains on a flat plane.</p>

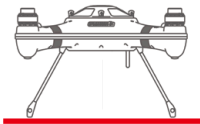

Place the drone down and wait for the Drone Status Indicators to stop flashing Red-Green-Yellow.

11. Switch the Return Home switch back to the Normal position.
12. Power OFF the drone, wait a few moments and then power ON the drone.
13. Power OFF the controller, wait a few moments and then power it back on.
14. Power on the drone



Alternating - Red, Green,  
Yellow slow flashing

Six-sided Calibration mode

## Preparation Before Every Flight

Drones are fun to fly, but they are not toys. Be a responsible pilot and prepare for your flight properly to fly safely and get the most out of your SplashDrone 3+. Follow this checklist before every flight.

- Is the drone properly maintained & all parts working & free of corrosion.
- Are all batteries charged?
- Is calibration completed?
- Are propellers secured properly?
- Is the payload accessory securely fastened and properly connected?
- Are the Drone Status Indicator lights showing errors?
- Is The GPS hatch properly closed & secured down?
- Are all switches on the remote in the UP position for takeoff?
- Are there at least 10 satellites for GPS flight and Return Home functions?
- Is the drone battery showing at least 16v? Is the remote battery indicator showing green?
- Are antennas pointing down and out for best reception?
- After take-off always check hover stability at low altitude.
- After flights on salt or dirty water, always thoroughly rinse all moving parts in fresh water.



## Remote Controller

---

This section introduces the remote controller functions.

---

 The default remote controller configuration is for left hand throttle. If you prefer to have right hand throttle, please consult the Advanced Settings section of this manual.

---

## Remote Controller Overview

The SplashDrone 3+ Remote Controller operates using two frequency bands, 2.4GHz and 5.8GHz. 2.4GHz is for the drone control and 5.8GHz is for the FPV video signal. The controller also incorporates control functions for payload accessories such as cameras and release devices. The drone itself is water resistant to IPX4, however the remote is **NOT** water or splash resistant.

### Power ON and Power OFF

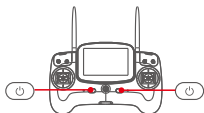

1. Ensure ALL switches are in the UP (top) position.
2. Press and hold both power switches for 3 seconds. The Remote Controller will power ON.
3. To turn OFF the Remote Controller, return the Camera Control switch to the Preview position to stop any recording.  
Press and hold both power switches for 3 seconds. The Remote Controller will power OFF.

### Airdrop Switch

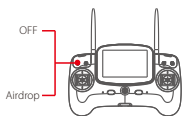

- OFF: Close Airdrop release  
Airdrop: Releases the payload

### Camera Control

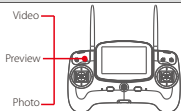

- Video: Record Video  
Preview: Preview  
Photo: Take Picture

### Flight Mode

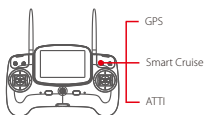

- GPS: GPS mode  
Smart Cruise: Smart Cruise Mode  
ATTI: ATTI mode

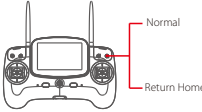
Return Home	
	<p>Normal: Return Home is disabled  Return-Home: Activate Return Home</p>

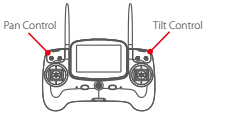
Gimbal Control	
	<p>Tilt Control Wheel: Controls the gimbal tilt  Pan Control Wheel: Controls the pan or roll of the gimbal</p>

## Drone Control

### Mode 1\* - Left hand throttle- (American/European configuration)

#### Left Joystick

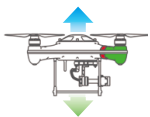

#### Right Joystick

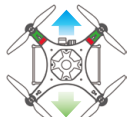

\* If you have reconfigured your Remote controller for Mode 3 - right hand throttle, the functions of the joysticks is reversed.

## Low Battery Alarm Warnings

The SplashDrone 3+ has three battery alarm levels:

**Level 1 alarm:** The drone battery level has reached 14.6V.

The FPV screen will display a large battery icon in the middle of the screen to prompt you to return the drone if it is not nearby and prepare to land. The Drone Status Indicators on the rear arms will flash a pattern of 3 yellow lights.

**Level 2 alarm:** The drone battery level has reached 14.4V. The battery icon on the FPV screen will flash. The battery level is now below 20%.

**Level 3 alarm:** The drone battery level has reached 14.2V. After 10 seconds, the drone will initiate in in-place **Auto Landing to protect the drone and battery**. The LED on the rear arms will flash yellow constantly. The FPV will display "FS" in the lower-left corner to indicate that flight-safety mode is active.

**Should it be necessary to prevent the Auto-Landing, switch the drone into ATTI mode to regain manual control and land the drone.**

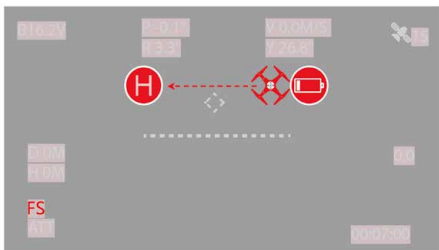

- ⚠ During flight it is important to constantly monitor the battery voltage as flying conditions like strong wind and fast movements can deplete the battery more rapidly.
- ⚠ It is dangerous to continue flying the drone with insufficient battery power. This could result in damage to the battery and risk of the drone crashing.

## Flight

---



This section introduces and discusses flying hazards, flight restrictions and planning.

## Introducing you to Flying a Drone

If this is your first time flying a drone, please read this manual thoroughly and watch the instructional videos on our YouTube channel. We recommend taking professional training and guidance. When flying, select an environment appropriate to your skills.

It is advisable for all drone pilots to become familiar with flying in ATTI mode in case of GPS or magnetic interference which can interfere with drone controls.

## Flying the SplashDrone

1. Do not fly in fog or if the wind is strong or gusting above 15 knots resistance.
2. Select an open place or water surface as an ideal flying site.  
Flying between or near large steel buildings could adversely affect the workings of the compass and can adversely affect or block GPS and control signals.
3. During flight, maintain line of sight with the drone, keep away from obstacles and people.
4. Do not fly near high voltage power lines or communication towers which may interfere with the remote controller of the drone.
5. Flying higher than 4000 meters above sea level, environmental factors including air density reduce the performance of aircraft and therefore also propulsion batteries.

## Default Flight Restrictions

According to provisions of the **New Zealand CAA**, drones must be operated in specified airspaces. By default the SplashDrone 3+ is configured to not exceed an altitude of 200m from the Home Point.

These limits can be reconfigured if necessary by utilising the SwellPro Assistant software.

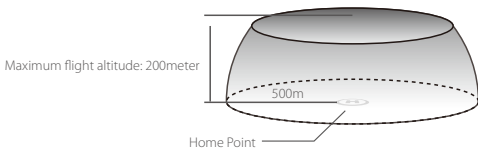

---

⚠ When flying in ATTI mode, there are no Geofence Limitations.

---

### Precautions Before Unlocking the Motors:

---

- 💡 Place the drone in an open area at least 3 meters away from you and others.
- 💡 For safety, always stand upwind and to the side of a drone for takeoff and landing, and face the nose of the drone (as indicated by the arrows) away from you.
- 💡 While the drone is completing its power-on self-check, please keep the drone stationary.
- 💡 In GPS flight mode, the motors cannot be armed (started) until there are at least 9 satellites for position control. In ATTI flight mode, there is no need to wait to unlock the motors.

### Unlocking the Motors

---

Pull both the left and right joysticks simultaneously down and inwards and maintain this position for 3 seconds. The motors will now be unlocked, and will start rotating.

Normal

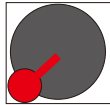
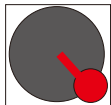

#### Switch and Joystick command to Arm Motors

If the motors **will not arm in GPS mode with more than 9 satellites**, but will arm in ATTI mode:

The drone may sense compass or gyroscope interference. This may be due to situations such as a rocking boat or nearby magnetic interference. In this case, **please calibrate the drone**.

If the SplashDrone **will not arm in ATTI mode**, refer to the calibration section elsewhere in this manual.

If the SplashDrone **arms in ATTI mode but then shuts down**, power down and restart the drone to reset the Flight Controller.

## Locking/Stopping the Motors

---

To lock the motors: Pull both the left and the right joysticks downwards and outwards. Alternatively, if the drone has landed, it is also possible to hold the throttle in the minimum position for 3 seconds.



### Switch and Joystick command to Lock Motors

---

**⚠ The motors can be stopped in an emergency.** Stopping the motors whilst airborne may cause the drone to crash and should only be carried out in emergencies (for example: there is a risk that the drone may hit people or crowds) if stopping the motors will minimize any potential damage.

---

## Basic Flight Steps

1. Check that the drone is correctly assembled, propellers are tight and the main hatch is sealed.
2. Power on the remote control, followed by the drone.
3. Place the drone on a flat open surface or on the surface of the water.
4. Wait for the FPV screen to display the camera's live video and the OSD flight data. Check that the flight display is normal.
5. Check the following flight data:
  - Battery voltage > 16volts
  - Satellites > 13
  - Yaw (Y) indicates the drone's current compass direction, and there are more than 6.
- For safety, you should stand upwind and to the side of the drone and at least 3 metres distant.
7. Arm the motors in GPS mode.
4. Push the THROTTLE joystick up slowly, allowing the drone to take off smoothly. Release the throttle when the drone is approximately 1.5 high. Allow the drone to hover for a moment to ensure flight stability. Always use gradual, smooth joystick movements.
5. When you need to descend, slowly pull down the throttle joystick, whilst flying the drone, allowing the drone to descend, and land on a flat surface, or on the water.
6. After safely landing, keep the throttle down in its lowest position for at least 5 seconds until the motors have stopped or use the disarm joystick command.
7. Stop recording video before powering down the drone, followed by its remote controller.



## Water Take-offs and Landings

1. Only land and take off in calm water conditions.

2. When landing on water, descend vertically to the surface. If the drone lands with horizontal speed, it is possible the drone can flip and be inverted. The flight controller will shut down the motors if the drone becomes inverted.

- ⚠ Do not leave the drone floating inverted for more than a few minutes. Flip the drone using the Power-Flip command or recover the drone as soon as possible to avoid water entering the drone.

## Power-Flip

If the drone becomes inverted on the surface of the water, using the Power-Flip feature, the drone can be flipped so that it is right-side up.

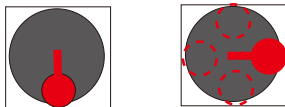

### Joystick command to Power-Flip the SplashDrone 3+

With the drone floating upside-down, pull the left-hand (throttle) joystick straight down to the minimum and simultaneously push the right-hand joystick either up, down, left or right depending on the direction of flip required.

## Take-offs and Landings from a Boat

When taking off from a boat there needs to be sufficient space, otherwise the drone should be placed on the water for take-off. Likewise, it is safer and easier to land the SplashDrone on the water beside the boat rather than landing on a rocking boat or where there is insufficient space for a safe landing.

If the boat is rocking, the SplashDrone 3+ may not arm its motors in GPS mode. Also be aware that aluminium boats may affect your ability to correctly calibrate the drone compass.



For safety, it is not recommended to launch or land your SplashDrone from your hands.

---

Be aware of the direction of the wind relative to the boat. Even when at anchor, it is possible that the wind will not be at the nose of the boat.

Always try and take off with the wind so that the drone will be taken away from the boat. When landing the drone onto a boat, if possible land against the wind so that the drone will be held away from the boat. The Smooth+ controls of the SplashDrone 3+ are useful to finely control and balance the drone position.

## Advanced Settings

---

This section describes advanced settings for the drone and its settings

## Video Transmitter Channel Selection

Selecting the channel (there are a total of 40 channels)

There is generally NO NEED to change the channel frequency under normal conditions. Your new drone comes with the box setup to send & receive video signal.

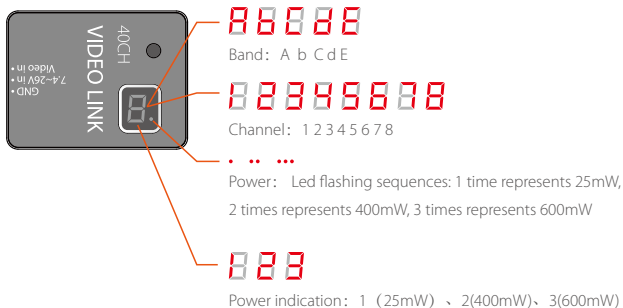

### Channel Selection

After powering on the transmitter, it will initially display the currently selected frequency band, followed by the current channel, and, in the lower right corner, a red dot flashing indicating the currently selected transmission power level as described above.

**For example: To set up channel E5:**

1. Long press the button for 3 seconds, it initially enters band selection mode and will automatically scroll between the bands (A, B, C, D, E). When it reaches "E", short press the button to choose E band.
2. To adjust channel to E5, short press the button 4 times. When the display shows frequency band E and channel 5, long press the button for 2 seconds, the dot in the lower right corner will flash once to confirm the selection, release the button. On completion, the system will display "E" first, followed by "5", and finally the dot will flash representing the transmission power level.

## Power Selection

1. To enter the power-switching mode, long press the button for 5 seconds, the system will then display the currently selected power level, corresponding to the number of slow flashes. If you need to change the power level, press the button to select the desired transmission power level.

2. After selecting the required power level, press the button for 2 seconds, the dot at the lower right corner will flash once, confirming your selection, and then exit from the power selection mode. Release the button, the system will now confirm your selections of the band, channel and power level, firstly showing you the selected band, then the selected channel and finally the transmission power level represented by the number of flashes of the red dot.

3. Please note: We recommend running at 400mW video power level when operating within an 800 metre radius, this level is a good nominal level and also extends the flying time. If it is required to fly in areas of obstructions and/or exceeding 800m, it may be necessary to switch to 600mW transmission power.

## Remote Controller Pairing (to the drone)

**Your drone comes paired with the remote controller out of the box. Only attempt to pair if the two become unpaired for some reason.**

1. Connect the jumper (which is supplied with the drone) into the B/VCC channel of the remote receiver located inside the drone. Then power on the drone, the receiver red light will flash fast and indicates the start of the pairing sequence.

2. Hold either left or right pairing button (No.2 or 17), then power on the remote controller. When the left indicator turns solid red, pairing mode is active. Release the buttons when the indicator changes to solid green. Pairing is successful.

3. Power OFF the drone and remove the Jumper cable from the receiver.

---

 When the pairing is completed, remove the JUMPER on the receiver's B/VCC channel.

---



## Remote Controller Joystick Calibration Method

1. Using the left hand index finger, hold the left joystick in the lower left position at 45 degrees.
2. Using the right hand index finger, hold the right joystick in the lower left position at 45 degrees.
3. Now, using both thumbs, simultaneously press the power buttons to start the remote controller.

The left led will flash fast.

4. Now press the button at the back of the controller on the right hand side behind the GPS and the return home switches.
5. Actuate the left joystick to its fullest extremes into each corner
6. Actuate the right joystick to its fullest extremes into each corner.
7. Actuate the wheels on the back of the controller to their fullest extremes.
8. Press the button at the back right hand side of the controller to confirm and complete the calibration procedure.

If the procedure is a success, the left hand led will flash slowly.

If the calibration is not correctly done, the left led will continue to flash fast, and a beep will sound.

9. On completion, please power down and restart the controller.

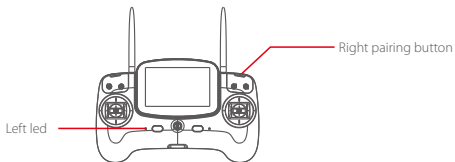

- 
- ⚠ The Remote calibration is complete when the throttle calibration is done.
  - ⚠ Before commencing calibration, please make sure that all the toggle switches are set to the top position.
- 

**JOYSTICK calibration should be attempted only if required.**

## Appendix

---



## Specifications

### Aircraft

Water resistance Level:	IPX4
Drone Weight:	1447g (without battery)
Axis Diameter:	450mm
Max Ascend Speed:	4m/s
Max Descend Speed:	3m/s
Max Flight Speed:	20m/s (ATTI mode)
Max Flight Altitude:	<b>120m max by NZ Law</b>
Max Flying Wind Speeds:	<b>a. 15 knots</b>
Hovering Precision:	±0.5meter
Max Flight Time (per charge):	<b>19 minutes</b>
Max Flight Range:	1km
Max Flight Weight:	3KG
Max Payload Capacity:	<b>1KG Deadweight</b>
Positioning Satellite:	Dual Satellites - GPS/GLONSS
Flight Controller:	Swellpro S3
Motor:	#3510/620KV
ESC:	40A
Propellers:	#1242 carbon fiber quick-fit propellers
Working Temperature:	-10 °C ~ 40 °C
Battery Types:	4S 15.2V 5200mAh LiHV battery
Battery Weights:	561g (5200mAh LiHV)
Charging Time:	90 minutes

### Remote Control

Weight:	660g
Frequency:	2405 ~ 2475HMZ
<b>Control Range:</b>	<b>Up to 1km (unobstructed, free of interference)</b>
Receiver Sensitivity(1%PER):	-105dbm
Working Current:	160-300mAh
No. of Channels:	10
Battery:	2S 7.4V 1800mAh lipo battery

**MAX VIDEO RANGE : 500m**

## FPV Screen

Frequency:	5645 ~ 5965HMZ
Screen Size:	5inch
Resolution:	800X480Pixels
Brightness:	500 cd/m <sup>2</sup>

## Warranty Information

### FLIGHT BATTERY -Safety Guideline



#### Warning:

Please read the ENTIRE user manual & support document to familiarize yourself with the features of this product before use. Failure to use this product in a safe and responsible manner could result in fire, serious injury or damage to the product, or other property, please observe the following safety guidelines when using, charging, or storing the batteries.

### 1. Battery Use

- DO NOT allow the batteries to come into contact with any kind of liquid.
- DO NOT drop the battery into water.
- DO NOT leave batteries out in the rain, or near a source of moisture. If the inside of the battery comes into contact with water, chemical decomposition may occur, potentially resulting the battery catching on fire, and may even lead to an explosion.

- NEVER use or charge swollen, leaky or damaged batteries. If your batteries are abnormal, please contact **JCMATTHEW or an authorized service agent**.
- The battery can be used in the temperatures ranging from -10°C to 40°C. Use of the battery in environments above 50°C can lead to a fire or explosion. Use of the battery below -10°C can lead to permanent damage.
- NEVER disassemble, or penetrate the batteries with sharp tools, otherwise, this may result in the battery catching fire, or even lead to an explosion.
- Electrolytes in the battery are highly corrosive. If any electrolytes make contact with your skin or eyes, immediately wash the affected area with fresh running water for at least 15 minutes, and then see a doctor immediately.
- If the battery falls into water, pick it up immediately and put it in a safe and open area. Maintain a safe distance from the battery until it is completely dry. Never use the battery again, and dispose of the battery properly as described in the Battery Disposal section below.
- DO NOT heat batteries. A battery fire can be extinguished using sand, or a dry powder fire extinguisher.
- DO NOT put batteries in a microwave oven, or in a pressurized container.
- DO NOT put the loose battery cells onto any conductive surface, such as a metal table.
- DO NOT put any conductive cables or metal objects together with batteries, where they may short-circuit against each other.
- DO NOT drop or strike batteries. DO NOT place heavy objects on the batteries or the battery charger.
- Clean battery terminals with a clean, dry cloth. Failure to do so may result in poor electrical contact, which could reduce the battery capacity, or damage the charger.



**DO NOT continue to fly the drone after the low battery alarm has been activated, this will result in over-discharging the battery, and potentially could damage the battery cells.**

## 2. Battery Charging

### Attention:

While charging the battery, in order to avoid any potential accidents happening during charging.

- Always use a SwellPro approved charger to charge the battery of the drone, and the radio controller. SwellPro or JCMATTHEW takes no responsibility if the battery is charged using a non-SwellPro SplashDrone 3+ LiHV charger.

- In order to avoid any potential accidents happening, please do not leave the battery charging unattended.
- DO NOT charge the battery near flammable materials, or on flammable surfaces, such as carpet or wood.
- DO NOT charge battery immediately after flight, because the battery temperature may be too high.
- DO NOT charge the battery until it cools down to near room temperature. The ideal charging temperature range is 4°C ~ 40°C .
- Disconnect the charger when not in use. Examine and maintain the charger regularly.
- DO NOT clean the charger with denatured alcohol or other flammable solvents.
- NEVER use a damaged charger.

### **3. Battery Storage and Transportation**

- Keep batteries out of the reach of children and pets.
- DO NOT leave the battery near heat sources, such as a furnace, heater, or exposure to strong direct sunshine, for example: in cars.
- The ideal storage temperature is 22°C ~ 28°C.
- Keep the battery in a dry and ventilated environment
- NEVER drop the battery into water, or store it in places where there is a possibility of water leakage.
- DO NOT drop, strike, impale, pierce, or manually short-circuit the battery.
- Keep the battery away from metal objects, such as watches, jewelry, and hairpins.
- NEVER transport a damaged battery, or a battery with power level higher than 50%. DO discharge the power to 50% or less before transportation.( The suggested battery voltage level of the drone is around 15.8V, and the radio controller is 7.9V)
- If the battery won't be used within 10 days, please discharge the power level to 50% for storage.

### **4. Battery Maintenance**

- NEVER use the battery when the temperature is too high or too low.
- Never store the battery in environments with a temperature higher than 60°C .
- If the battery won't be used for a long period, please fully charge it, and then discharge its power level to 50% to maintain its effectiveness.
- NEVER store the battery for a long time after use, it will become over-discharged, and definitely ruin the battery.
- NEVER over charge the battery, or the battery cells will be damaged.

## 5. Battery Maintenance

- NEVER use the battery when the temperature is too high or too low.
- Never store the battery in environments with a temperature higher than 60°C .
- If the battery won't be used for a long period, please fully charge it, and then discharge its power level to 50% to maintain its effectiveness.
- NEVER store the battery for a long time after use, it will become over-discharged, and definitely ruin the battery.
- - NEVER over charge the battery, or the battery cells will be damaged.

## 6. Battery Disposal

- Dispose of the battery in specific recycling boxes only after a complete discharge.
- DO NOT place the battery in regular trash containers. Strictly follow your local regulations regarding the disposal and recycling of batteries.

### Safety Operation Guideline & Disclaimer and Warning

#### Safe Operation Guidelines

##### 1. Flying Conditions and Environmental Considerations

- Fly in open spaces or above the water surface that is far away from crowds. Only fly the SplashDrone 3+ to a maximum altitude of 4000m above sea level (& then only up to 120 m from the ground).
- The operating temperature range of the SplashDrone 3+ is -10°C to 40°C.
- Observe local regulations and flight restrictions of your Aviation Authority.

##### 2. Pre-Flight Inspection and Checks

- Make sure all batteries are fully charged.
  - Check all propellers are in good condition and correctly fastened. The edges of the propeller blades must be smooth and undamaged.
  - Manually rotate the 4 motors to ensure they can spin smoothly.
- Ensure the sealing surfaces of the cover are clean, free of dirt, sand, or any other contaminants.
- Make sure the GPS top cover is facing the front of the drone and all the screws are properly fastened.
  - Please make sure when tightening the hatch screws that they are not cross-threaded and are firmly tight, but not over-tightened.
  - Make sure the drone fuselage is sealed and that the membrane on the top of the GPS hatch is in good condition.

### 3. Flying Guide

- **New Zealand** regulations require the pilot to fly a drone within line of sight. Ta
- Unless it is an emergency, NEVER Lock or STOP the motors in flight as this will cause the drone to fall to the ground and crash.
- When the low battery level warning is activated, plan to return the drone and land safely before the battery reaches a critical level.
- The Return Home function can be used to reorient the drone towards the Home Point. By activating the Return Home function, the drone will rise to the the return altitude (20m) and then turn towards the Home Point before starting its return.
- If any obstacles are in the flight path of the drone during a Return Home process, control should be regained by turning off the Return Home function.
- If you inadvertently crash your drone, lock the motors **upon impact** to prevent damage to the motors and propellers.
- Do not attempt to touch the motors, until the motors have stopped rotating.
- When taking-off & landing from water, avoid high-speed or abusive landings to avoid damaging the drone.
- When flying over water, avoid allowing the drone to drop or crash into the water from a high altitude as this could cause major damage to the drone.
- Don't expose the drone & battery to direct sunlight for sustained periods of time as this can raise the internal temperature of the drone to well above the operating temperature range.
- **When in flight** if the drone does not appear to be responding to the Remote Controller as usual, switch the Drone to ATTI flight mode and fly the drone to a safe landing location.

#### **The possible causes for the instability or loss of control of the drone could be:**

- The drone has been subjected to unstable GPS signal/s or spurious interference/effects on the Compass module during flight.
- The calibration of the drone (compass and/accelerometer) was incorrectly carried out.
- The battery cable was not correctly positioned behind the battery and as far as possible from the compass module.

#### **Steps that can be taken to resolve the issues:**

- Re-calibrate both the compass and accelerometer on the SplashDrone.
- After completing the calibration, arm the drone motors to fly in GPS mode to verify whether this phenomenon has been eliminated.
- Make sure there are no WIFI signals operating in the area & that your phone wi-fi is turned off. Make sure there is no radio interference in the area.

- If the abnormality remains the same, please re-locate to another place at least 5KM away and re-calibrate the SplashDrone. Following the re-calibration, please test the drone again.
- If the problem persists, please contact JCMATTHEW or an authorized service centre for assistance.

#### 4. Maintenance

- Please make sure to double check the propellers after flight, distorted/damaged props should be replaced immediately.
- After flying over the sea or other corrosive waters, please wash the outer modules of the drone with fresh water within 2 hours, especially the motors, the gimbal structure and mounting brackets of the landing gear.
- It's strongly advised to rinse the drone before the salt crystalizes.
- In the event of the SplashDrone not being used for a long time, please store the drone and the batteries in a dry, and ventilated environment, within a temperature range of 20°C~28°C.
- Please refer to <Safety guideline with batteries> for further details on maintaining the batteries.

#### 5. Flight Safety

- Please make sure you have a comprehensive understanding of the SplashDrone, and all the necessary measures required to implement a successful return home function, in the event of an emergency.
- Please be well prepared before each flight, avoid any violent or excessive operations.
- Please maintain strict compliance with the local laws, any flying in NO-FLY ZONES is prohibited. **Follow any local or New Zealand laws as laid down by the CAA.**
- Any illegal & improper use or operation of this product is highly prohibited.
- Any invasion & violation against another person/s right of privacy is not allowed. Before using this product, it remains the duty of the drone pilot to comply with the local laws regarding privacy protection. **Please see the CAA.**
- Any invasion or flying over another person/s property is not allowed, please agree with any person/s regarding any potential breach of privacy before the proposed flight.
- Any flights in or around the strong magnetic fields are highly prohibited, these influential factors include wireless electricity emission towers, High-voltage transmission lines, substations, radar and other magnetic sources or metal objects.
- DO NOT fly the SplashDrone under the influence of alcohol, drugs or any other physical or mental impediment.
- Please don't fly the drone with a malfunctioning radio controller - Please fly the drone away from crowds.

---

## Restricted Area



Airport



Crowds

## Threats to Flight Safety Scenarios



Radio signal tower



Radar



High voltage power lines



Trees



Tall buildings

---

## Disclaimer and Warning



This product is not a toy, and should only be operated by persons over the age of 18. Please keep it out of reach of children, and pay particular attention to the possible scenarios of children's unexpected appearance during flight operation.

Be sure to read this document carefully before using the product, to fully understand your legal rights, responsibilities and safety instructions. Failure to do so, may cause property damage, safety accidents and personal safety risks. Once this product is used, it is deemed that you have understood, recognized and have accepted all the terms and conditions of this statement. The user is responsible for all the consequences of his actions and consequences. The user agrees to use the product for his sole & legal purpose, and agrees with the terms & conditions of this agreement, and other relevant policies & guidelines that may be specified by SwellPro.

Under the maximum permission by law and approved circumstances, **SwellPro and JCMATHEW** is exempt of liability for any indirect, punitive, consequential, special or criminal damages, including the purchase cost, or for loss of income due to the loss of use of the drone.

**SwellPro & JCMATHEW** are exempt from the user's liabilities for damage(s) to person/s or property, or injuries incurred directly or indirectly from the use of this product in the following conditions:



- Damage or injuries incurred when the user/s are under the influence of alcohol, drugs or medication.
- Any malfunction caused by operators' failure to follow the guidance of the manual to assemble and set up or operate the drone as described and designed.
- Damage or injuries that may occur due to failure to study the tutorial videos and the user manual before flying the drone.
- Damage or injuries caused to a person/s or property due to failure in correctly calibrating the drone as outlined in the manual prior to flight.
- Damage or injuries incurred as a result of the use or installation of any unauthorized third party accessories or counterfeit parts - which were not provided and approved of by SwellPro.
- Damage or injuries as a result of flying the drone out of eyesight range, or more than 300m away from the controller.
- Damage or injuries caused by flying the drone in areas of magnetic fields & radio interference.
- Damage or injuries caused by flying in a NO-FLY ZONE that is regulated by local laws & rules.
- Damage or injuries including crashes, loss of control or water ingress caused by abusing or modifying the original drone structure,
- Damage or injuries caused by using broken & ageing components.
- Damage or injuries caused by continuing to fly the drone even if the low battery alarm is activated.
- Damage or injuries caused by failure to wash the components with fresh water after flying over or near the sea & corrosive waters.
- Damage or injuries that have occurred when the drone has been subjected to the following conditions or situations: collision, fire, explosion, floods, tsunamis, ice, snow, avalanche, flooding, landslide, earthquake, etc.
- Damage or injuries incurred by intentionally dropping or crashing the SplashDrone into the water from a high altitude, especially water ingress into the drone fuselage and gimbal malfunction.
- Damage or injuries incurred by intentionally dropping or crashing the SplashDrone to the ground or water from a high altitude, especially water leakage into the drone fuselage and gimbal frame as a result of this collision.
- Other Damage(s) or injuries that are not SwellPro's liability.

## Version Information

SwellPro products are constantly being improved. Therefore, although the latest version of this manual may contain information relating to a release of the equipment different from your own, new information is added constantly which is relevant to ALL customers

Version	Comments
1.1	New Manual for SplashDrone 3+

### (1) Drone Water Resistance Information

Please be aware that SplashDrone 3+ Models (NZ Specific) are water resistant – **which means they will resist the entry of water to an IPX4 level, but** Splashdrone is designed to be NOT completely waterproof or sealed for technical reasons & therefore is not meant to be submerged under water or landed in surf conditions. If the Splashdrone comes in contact with saltwater, the user is advised to wash any saltwater off with fresh water. Also It is always important to remove any excess moisture from inside the drone immediately following a flight OR a water-crash.

### Warranty Information

Please be aware that any attempt by any non-authorized repairer to either open the drone, or service the drone (including attempted self service or fitting of parts (either original or third-party parts)) WILL INSTANTLY VOID THE PRODUCT WARRANTY.

Warranty does not cover any mis-use of the product, or where the product has not been used in the accordance with the instructions found either in this User Manual OR the Support Document, that came with this drone.



