

OPERATING MANUAL | VIPER™ BEAD SEATER

MODELS

VP10S

VP13AL

VP18AL



READ INSTRUCTIONS THOROUGHLY BEFORE OPERATING

TSI TIRE SERVICE
INTERNATIONAL

July 29, 2019

800.223.4540

3451 S. 40th St., Phoenix, AZ | www.buytsi.com













Fax: 602.437.5025 | Email: sales@buytsi.com

Made in Taiwan/China



WARNING!

The instructions and warning contained in this manual should be read and understood before using or operating this tool. Do not allow anyone to use or operate this tool until they have read this manual and have developed a thorough understanding of how this tool works. Failure to observe any of the following instructions could result in severe personal injury to tool user and bystanders, or cause damage to the tool and property. Keep this manual for future reference.

-  **WARNING** - Indicates a potentially hazardous situation which, if not avoided, could result in death or serious injury.
-  **WARNING** - Personal Protective Equipment: Safety goggles, gloves, non-skid shoes and hearing protection.
-  **WARNING** - Keep bystanders and children out of the work area while operating this tool.
-  **WARNING** - Always keep work clean, uncluttered, and well lit. Do Not work on floor surfaces that are slippery.
-  **WARNING** - Do not operate this tool if you are tired or under the influence of alcohol, drugs, or medications that could affect your ability to use the tool properly.
-  **WARNING** - Air under pressure can cause severe injury. Never point an air tool at people or animals.
-  **WARNING** - Detach from air supply and release all air pressure before installing, removing or adjusting any accessory on this tool or performing maintenance. Failure to do so could result in injury.
-  **WARNING** - Do not open the Cheetah® Bead Seater air release valve when connecting the air supply hose. When the Cheetah® Bead Seater is not in use, discharge air from tank. Store with valve open in a clean, dry location. Never transport the Cheetah® Bead Seater with air in the tank.
-  **WARNING** - Do not tamper with the safety valve. Do not modify or alter the bead seater in any way.
-  **WARNING** - Inspect before each use. Do not use if broken, bent, cracked or damaged parts are noted (Including warning label). If the unit appears damaged in any way, is missing parts, or operates abnormally, it shall be removed from service immediately. All units that have been dropped, impacted suddenly, or dented should be removed from service.
-  **WARNING** - Only Cheetah® Bead Seating replacement parts should be used on the unit. Decals and parts are available through your Distributor or the manufacturer.
-  **WARNING** - The warnings, cautions and instructions discussed in this manual cannot cover all possible conditions and situations that may occur. It must be understood that common sense and caution are factors which cannot be built into this product, but must be applied by the operator.
-  **WARNING** - Operator should be familiar with all OSHA regulations (including 29 CFR 1910.177) pertaining to mounting, demounting and inflating all tires

Label Description



Pressurized Device



Eye and Ear Protection



Read the Manual

GENERAL INFORMATION

General: Remove contents from box and assemble as shown below Fig. 1. Read and follow instructions for optimum use.

Overview: VP10S, VP13AL and VP18AL tanks are ASME

All series are US Patent No. 6,179,033, TAIWAN Patent No M537535
China Patent Pending, Europe Patent Pending



WARNING!

AIR IN TANK CAN REACH HIGH PRESSURE



USE CAUTION! Wear safety glasses and hearing protection never discharge a Viper™ aimed at a person

Primary Features: Fig. 1

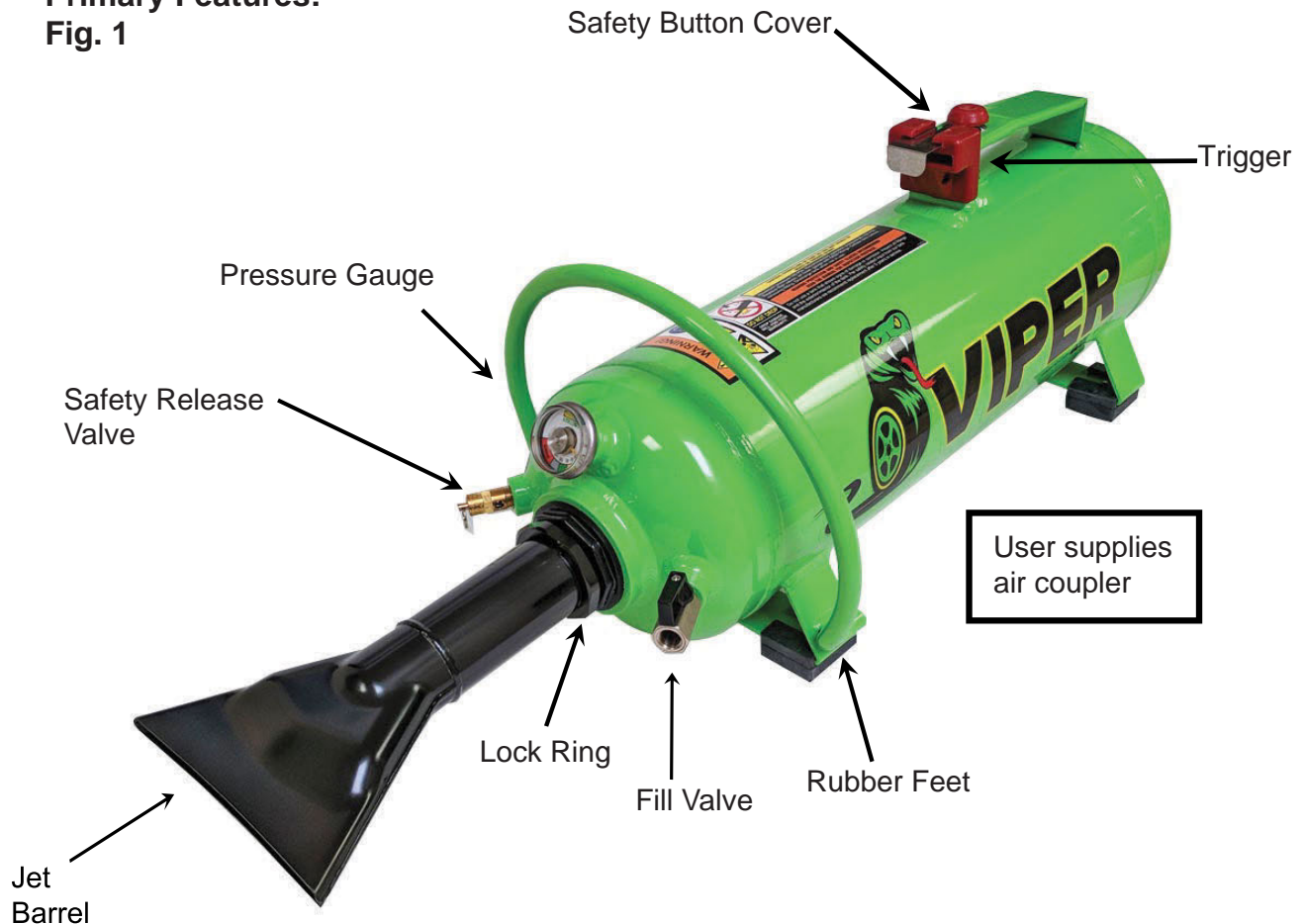

*Follow these instructions for proper bead seating methods and practices.

** Please note we recommend the use of a good quality inline filter to remove contaminants and moisture.

INSTRUCTIONS



WARNING!

DO NOT USE THE VIPER™ FOR ANYTHING BUT SEATING TIRE BEADS. Use of this equipment in an unintended manner could result in severe personal injury to tool user and bystanders or could cause damage to the tool and property.

Changing parts or making modifications to the Viper™ voids the warranty and TSI will not be held liable.

HOW TO USE:

IMPORTANT: Prepare each wheel. Clean rims. Dirty rim flanges and poor tire beads can create flying debris from the rush of air going into the wheel.

TSI suggests using a quick-disconnect fitting (not included) on the air line to attach the air line to the valve stem, we sell an optional whip hose part #01.109.

Remove valve stem core from wheel. Set aside to replace later after bead is seated. Lubricate tire beads and rim flanges with approved tire lubricant.

Before placing wheel on tire stand, connect whip hose to valve stem (Fig. 2). You may have to thread the air line or part of the whip hose through the rim center if the valve stem is facing the ground when on the tire stand. In most cases, the wide flange of the wheel should be facing up and connect air line to whip hose.



Fig. 2

As shown in Fig. 2 positioning a wheel on the tire stand will elevate both the tire and rim. The lower tire bead must be resting on the wheel bead-seat area. This alignment is very important to ensure the air blast is captured within the tire cavity.

Now you can attempt to seat the tire bead onto the rim.



WARNING!

NEVER TRANSPORT OR STORE A CHARGED TANK. Accidental discharge could cause serious injury or damage.



WARNING!

VIPER™ TANKS BLAST AIR AT A HIGH RATE.

For safety use proper body positioning. Use protective gear for eyes, ears and feet. DO NOT wear loose clothing.

NOTE: It's not always necessary to fill the tank to maximum pressure. The required pressure will vary depending on size and type of tire. It is best to begin with lower pressure and work up to optimum pressure for your specific tire.



Fig. 3.

Gather your footing. Open the whip hose to let air flow in through the valve stem. Firmly grasp the Viper™ tank with one hand on the forward handle and one on the rear. Aim the Jet Barrel at about a 35° - 45° angle (See Fig. 3) without touching the tire. Press the trigger (See Fig. 4) to discharge the tank.

Once the bead fully moves into position close the whip hose valve. Remove the whip hose locking chuck from the valve stem and replace valve stem core. With experience you will recognize filling the tank to capacity isn't necessary. The amount of air to seat the bead depends on the tire, most tires can be seated between 80 PSI -100 PSI. Several attempts to seat the bead may be necessary.



Fig. 4.
Trigger

Make sure the valve stem core is firmly tightened in place. You are now ready to place the tire into a tire care and proceed to inflate the tire to manufacturers tire pressure requirements.

Check for leaks. Address leaks and if necessary repeat process. If non are present, place valve cap on valve stem and wipe off excess lubricant.

ACCESSORIES

Jet Barrels

Patent Pending

VP1.5
1½" Jet Barrel



VP2.0
2" Jet Barrel





WARNING!

USE CAUTION! Wear safety glasses and hearing protection. Never discharge Viper™ while aimed at a person.

CAUTION: OVERFILLING OF TANK OR TIRE MAY RESULT IN DEATH OR SERIOUS INJURY

Maximum pressure 145 PSI. Recommended operation pressure 80-100 PSI. Replace filler valves, air hose, gauge with OEM fittings. Deflate tank before removing fitting. Discharge tank when not in use.

**HEARING PROTECTION AND SAFETY GLASSES RECOMMENDED
READ THE MANUAL FOR INSPECTION PROTOCOL**

Do not use a tank that shows signs of damage or corrosion. Inspect all fittings and the exterior/interior of the tank. Per safety related input from our tank manufacturers we recommend replacement after 5 years in service.

11.2016

The (5) years in service is based upon safety related input from our tanks manufacturers. Following the maintenance inspection protocol and good judgment of the user should be the final determination of the unit's safety and need for replacement. Under NO circumstances should you use a tank with signs of deterioration, damage or malfunctioning safety valves or gauges.

MAINTENANCE PROTOCOL

Use genuine TSI replacements parts. Use of non-TSI parts will void warranty. Under no circumstances should items be welded or attached to the tank. Use only stock parts as referenced in parts schematic.

TSI warranty does not cover a dropped tank or damage resulting from dropping the unit. Any tank that has been dropped or shows sign of damage should be immediately removed from service.

Daily: Inspect the pressure gauge and Safety Release Valve. Visually inspect the exterior of the tank for rust or deterioration.

Monthly: Pull the ring of the safety release valve to ensure the valve moves freely and isn't stuck.

Every six (6) months: Visually inspect the interior of the tank for rust or deterioration through inspection port. Shine a light into the tank to improve visibility.

Discontinue use of tanks should any of the maintenance items need service. Contact your Distributor or TSI at 800-223-4540 or 602-437-5020 for replacement parts or units.

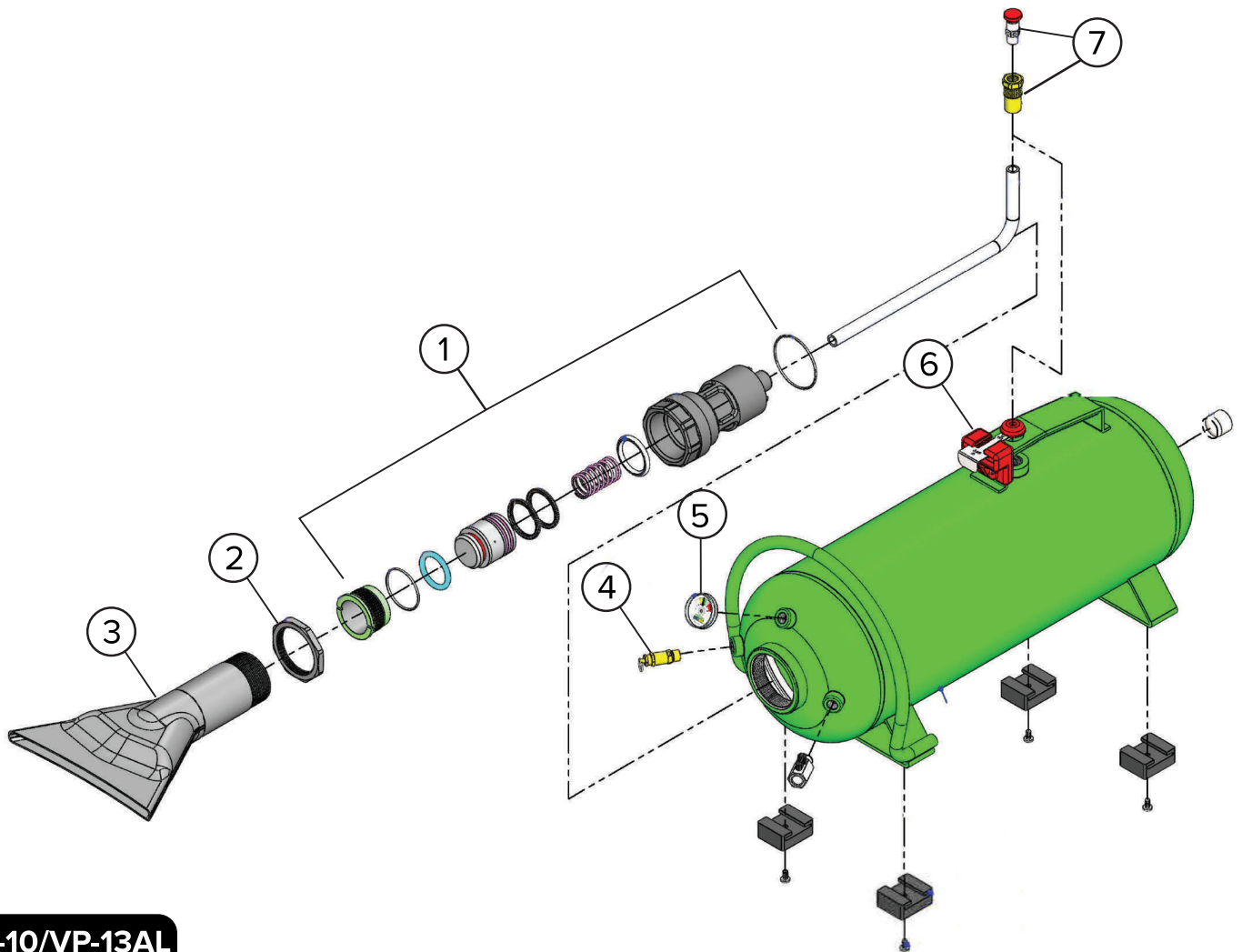

VP-10/VP-13AL

REPAIR PARTS

No.	Description	Part No.
1.	1 ½" Pressure Valve Kit	VP 1.5 CYL KIT
2.	1 ½" Lock Ring	VP 2.107
3.	1 ½" Jet Barrel	VP 2.103 JET
4.	Safety Release Valve	VP 5.102-145
5.	150 PSI Gauge	VP 1.106-150
6.	Safety Button Cover	VP PB SAFETY
7.	Viper Release Button	VP TRIGGER

Order parts from your distributor or jobber.
When ordering parts always give the following information: Part number, description and serial number of your machine.

PCL Connector is NOT INCLUDED must be purchased separately.

Reminder: Always exercise caution when using compressed air.

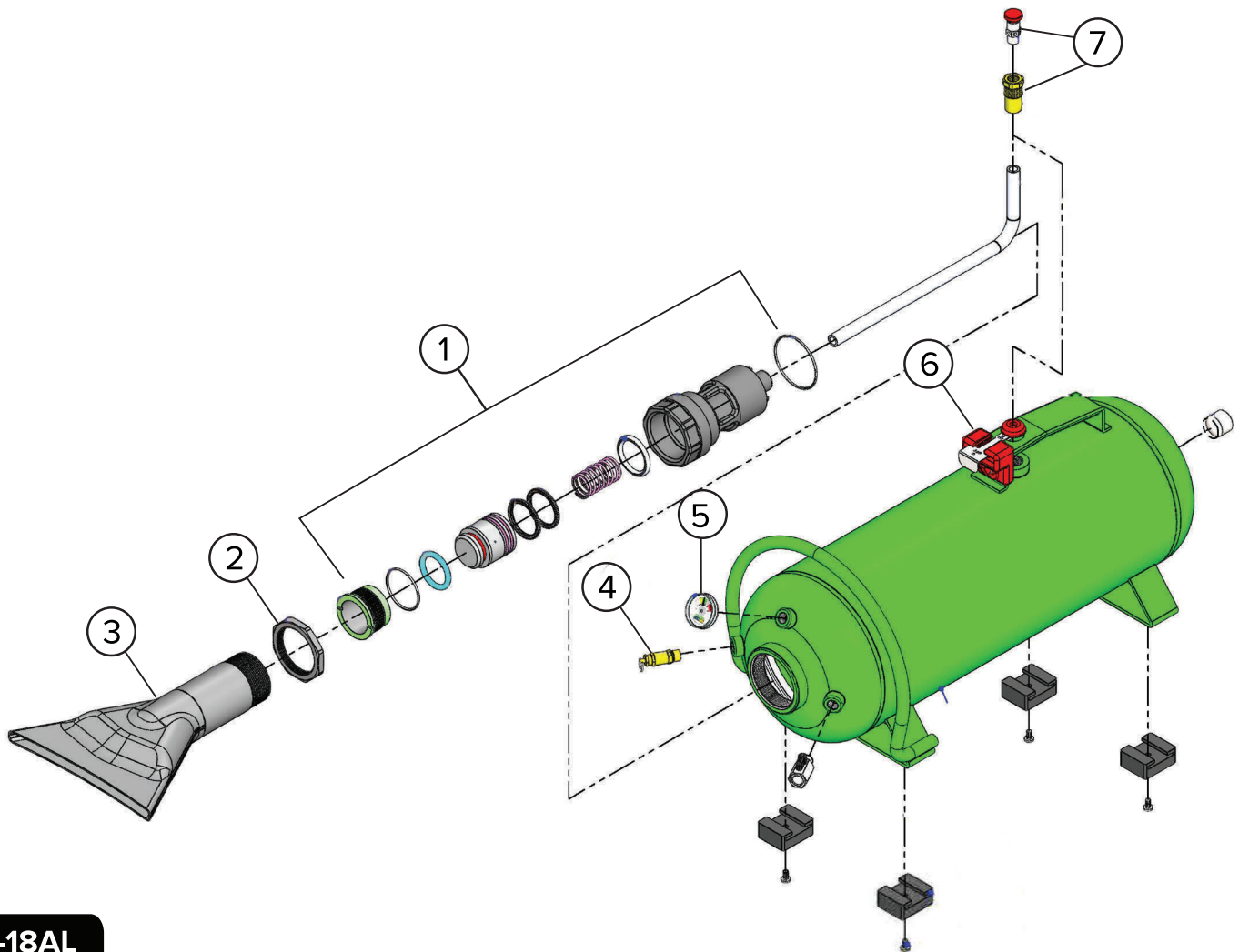

VP-18AL

REPAIR PARTS

No.	Description	Part No.
1.	2" Pressure Valve Kit	VP 2.0 CYL KIT
2.	2" Lock Ring	VP 3.107
3.	2" Jet Barrel	VP 3.103 JET
4.	Safety Release Valve	VP 5.102-145
5.	150 PSI Gauge	VP 1.106-150
6.	Safety Button Cover	VP PB SAFETY
7.	Viper Release Button	VP TRIGGER

Order parts from your distributor or jobber.
When ordering parts always give the following information: Part number, description and serial number of your machine.

PCL Connector is NOT INCLUDED must be purchased separately.

Reminder: Always exercise caution when using compressed air.

Warranty Statement & Return Policy

Warranty & Workmanship you can depend on.

With over 30 years of manufacturing experience we maintain the ability to provide competitive prices while employing and manufacturing the majority of our products in the USA. Pride in our workmanship and standing behind each and every product is not just our claim but our uncompromising responsibility.

Tire Service International equipment is warranted to be free from defects in materials and workmanship for a period of one year from the date of original purchase to the original owner. Repair labor is warranted for 90 days from the date of original purchase. Bushings, blades, bearings and normal wear and tear are not covered under warranty. Careless handling, negligence, misuse, abuse, mutilation, improper operation, making unauthorized repairs, additions, and or alterations automatically cancel this warranty and relieves TSI of any obligation. Cheetah tanks claimed to be defective while under warranty will be evaluated at our manufacturing plant and either repaired if possible or exchanged and returned or credit issued to the customer account at our discretion. Damage resulting from dropping the tanks will not receive warranty consideration. Warranty parts need to be returned prepaid to the plant for credit. Any replacement parts shipped from the plant will be shipped at the customer's expense. Machines requiring warranty work must be brought to the manufacturing plant in 201 Chelsea Rd, Monticello, MN or to a repair facility authorized by TSI.

Return Policy:

!!WARNING!! Goods returned without an RGA will be refused. A Returned Goods Authorization form must be obtained before returning any material or goods. All non-warranty returns will be subject to a 15% restocking fee plus any additional charges for reconditioning/repacking.



Rev 2.14.2019

3451 S. 40th St., Phoenix, AZ 85040 • Toll Free 800.223.4540 • Arizona 602.437.5020 • Fax 602.437.5025