

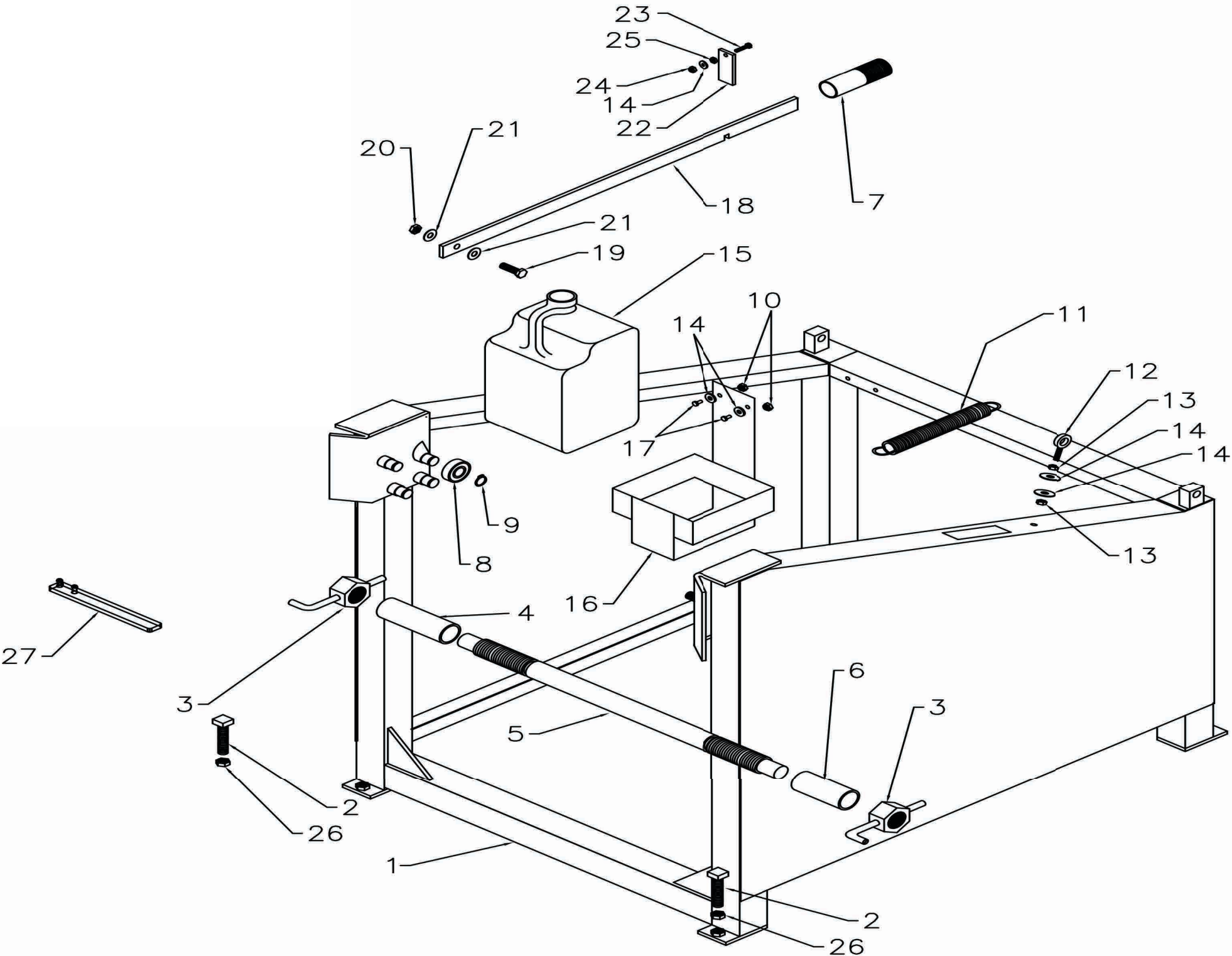

TIRE SERVICE  
INTERNATIONAL

# *ST BASE PARTS LIST*

10-20-16



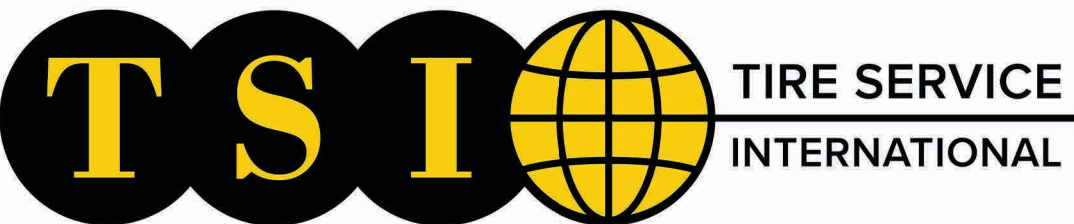

## *ST BASE PARTS LIST*

PHOENIX, AZ - MONTICELLO, MN 1-800-223-4540

ITEM	PART NO.	QTY	DESCRIPTION
1	56.834	1	LOWER FRAME
2	218.028	2	SET SCREW 1/2-13 X 2-1/2 LG.
3	2.849	2	TIGHTENING NUT
4	437.268	1	LONG TUBE
5	102.104	1	MANDREL SHAFT
6	438.268	2	SHORT TUBE
7	15.550	1	GRIP
8	79.107	8	BALL BEARING
9	77.044	8	RETAINING RING (EXT)
10	226	2	NUT, SELF LOCK 1/4-20
11	74.110	1	SPRING
12	269.028	1	EYE BOLT
13	214	2	NUT 1/4-20
14	445	5	WASHER 5/16
15	99.625	1	COOLANT CONTAINER
16	5677	1	CONTAINER BRACKET
17	4239	2	CAP SCREW 1/4-20 X 3/4 LG.
18	90.070	1	HANDLE
19	447	1	CAP SCREW 3/8-16 X 1-1/4 LG.
20	212	1	NUT, SELF LOCK 3/8-16
21	700	1	WASHER, FLAT 3/8
22	54.298	1	SAFETY SHIELD
23	3118	1	MACHINE SCREW #10-24 X 1 LG.
24	127.055	1	NUT, SELF LOCK #10-24
25	4570	1	NUT, HEX #10-24
26	26.055	2	NUT, HEX JAM 1/2-13
27	6.887	1	SPANNER WRENCH



TIRE SERVICE INTERNATIONAL

*SP, ST & STEM*  
*UPPER ASSY*  
*PARTS LIST*  
10-21-15

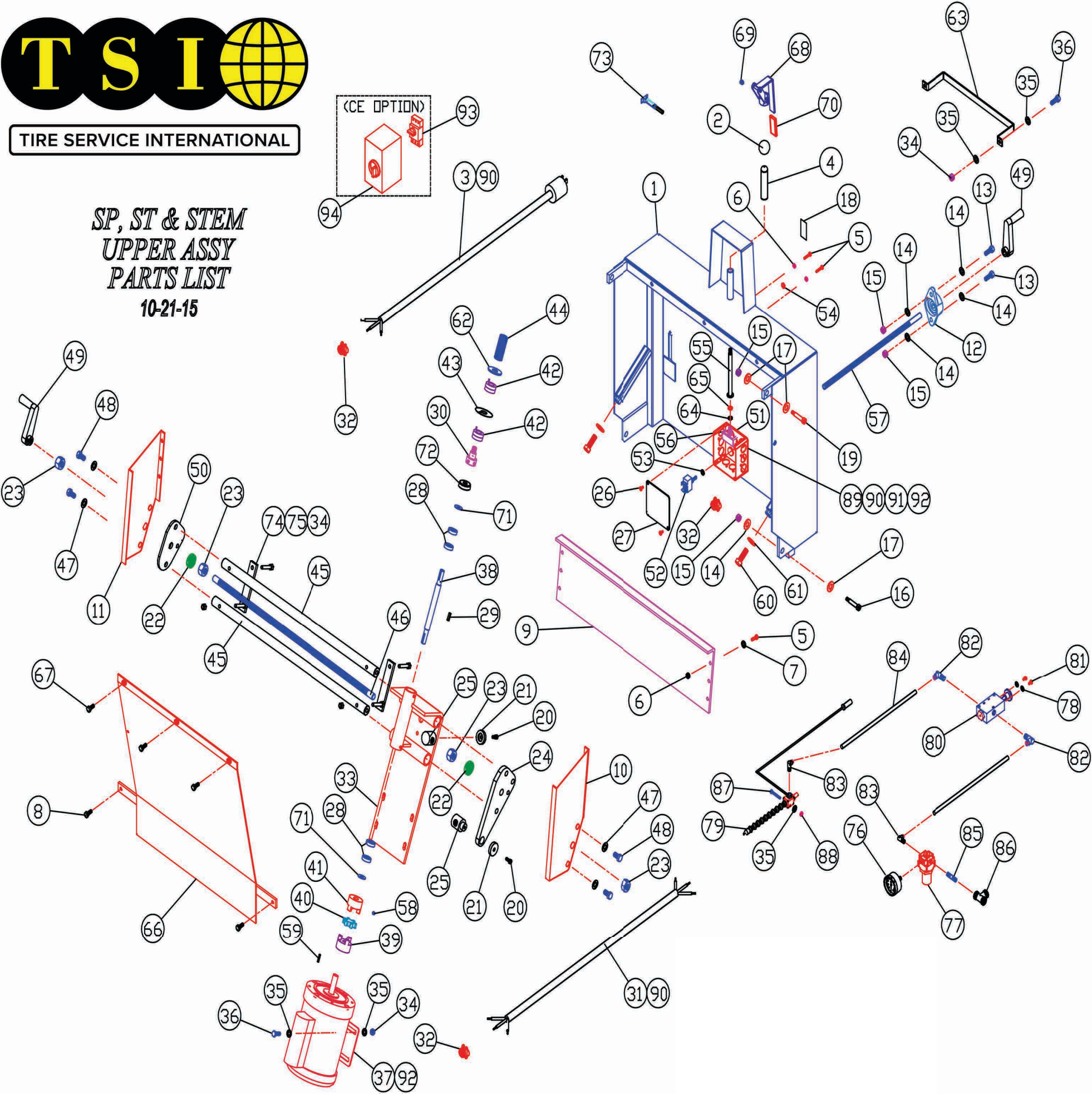



**TIRE SERVICE INTERNATIONAL**

# UPPER ASSY SP, ST STEM

REPAIR PARTS BOM

Page 1 of 3

PN: 0000

BEGINNING SERIAL NO.0000

10/13/2016

## PARTS LIST

ITEM	PART NO.	DESCRIPTION	QTY
1	18.825	UPPER COVER WELD	1
2	4780	KNOB	1
3	4243	CORD ELEC 3 PRONGE MOLDED PLUG	1
4	15.550	GRIP	1
5	903	CAP SCREW 1/4-20 X 3/4	8
6	226	NUT, SELF LOCK 1/4-20	8
7	445	WASHER, FLAT 1/4	6
8	4222	CAP SCREW, SELF TAP 5/16-18 X 3/4	2
9	4479	GUARD	1
10	4461L	GUARD, SIDE (LH)	1
11	4461R	GUARD, SIDE (RH)	1
12	75.107	PILLOW BLOCK BEARING	1
13	1306	CAP SCREW 3/8-16 X 1	2
14	1318	WASHER, FLAT 3/8	8
15	212	NUT, SELF LOCK 3/8	6
16	274.028	SHOULDER BOLT	2
17	224	WASHER, FLAT 1/2	4
18	4038-4	ON/OFF DECAL	1
19	273.028	SHOULDER BOLT	2
20	213.028	MACH SCREW 1/4-20 X 3/4	2
21	129.055	RETAINING NUT	2
22	4806	BEARING	2
23	40.489	SHAFT COLLAR W/SET SCREW (SERIAL #'S 1000-1215)	1
	4855	NUT, HEX W/SET SCREW (SERIAL #'S 1216- )	2
24	52.013	CROSSFEED GUIDE	1
25	128.055	CROSSFEED NUT	2
26			
27	4195	COVER, BOX FLAT 4" SQ	1

## PARTS LIST

ITEM	PART NO.	DESCRIPTION	QTY
*28	72.107	BEARING, BALL	4
29	33.251	KEY 1/8 SQ X 3/4	1
*30	53.242	DRIVE SHAFT ARBOR	1
31	4267	CORD ELEC (MOTOR TO SWITCH)	1
32	12255	STRAIN RELIEF 1/2 NPT	3
33	27.848	MOTOR MOUNT WELD	1
34	566	NUT, SELF LOCK 5/16-18	10
35	1318	WASHER, FLAT 5/16	15
36	3405	CAP SCREW 5/16-18 X 1	6
37	31.259	MOTOR 1HP, 60 HZ, 1725 RPM	1
*38	100.104	DRIVE SHAFT ARBOR	1
**39	31.034A	COUPLER 5/8 DIA BORE	1
**40	31.034C	SPIDER	1
**41	31.034B	COUPLER 1/2 DIA BORE	1
42	24.929	BLADE GUIDE (A) .250 CUT SPACING	1
	25.929	BLADE GUIDE (AA) .300 CUT SPACING	1
	26.929	BLADE GUIDE (D) .350 CUT SPACING	1
	27.929	BLADE GUIDE (E) .400 CUT SPACING	1
43	18.071	BLADE	1
44	62.242	LEAD SCREW (13) 13/32 CUT DEPTH	1
	55.242	LEAD SCREW (11) 11/32 CUT DEPTH	1
	56.242	LEAD SCREW (9) 9/32 CUT DEPTH	1
	57.242	LEAD SCREW (7) 7/32 CUT DEPTH	1
	58.242	LEAD SCREW (5) 5/32 CUT DEPTH	1
45	250.149	CROSSFEED ROD	2
46	54.242	CROSSFEED SCREW (SERIAL #'S 1000-1215)	1
	59.242	CROSSFEED SCREW (SERIAL #'S 1216- )	1
47	5.108	LOCK WASHER STAR EXT. 7/16	4



**UPPER ASSY**  
**SP, ST STEM**  
 REPAIR PARTS BOM  
 Page 2 of 3

PN: 0000  
 BEGINNING SERIAL NO.0000  
 12/21/2016

**TIRE SERVICE INTERNATIONAL**

PARTS LIST			
ITEM	PART NO.	DESCRIPTION	QTY
48	262.028	CAP SCREW 7/16-20 X 3/4	4
49	4954	CRANK W/HANDLE	2
50	51.013	CROSSFEED GUIDE	1
51	4194	BOX CONDUIT 4" SQ	1
52	4038-1	SWITCH, TOGGLE	1
53	4038-2	NUT, KNURLED	1
54	4038-3	NUT, HEX	1
55	5712	SHAFT SWITCH	1
56	3738-1	SWITCH PUSH BUTTON	1
57	61.242	ANGLE ADJUSTMENT SCREW	1
58	275.028	SET SCREW 1/4-20 X 3/8	3
59	572	KEY 3/6 X 1	1
60	206	CAP SCREW 1/2-13 X 1-1/2	2
61	535	NUT, HEX 1/2-13	2
62	224	WASHER	1
63	202.017	GUARD	1
64	3738-2	NUT, KNURLED	1
65	3738-3	NUT, HEX	1
66	5768	SHIELD WELD	1
67	1737	CAP SCREW 5/16-18 X 3/4	3
68	5786	HANDLE SWITCH	1
69	1308	SET SCREW 3/8-16	2
70	10031	GRIP	1
*71	4182	WASHER-SHIM 1/2 X 3/4 X .010	2
*72	10875	CUP, RETAINING	1
73	10652	TIRE TREAD DEPTH GAUGE	1
74	11964	BRACE, CROSSFEED ROD	2
75	3406	HHCS 5/16-18 X 1-3/4	4
76	7.023A	AIR GUAGE	1
77	15.190	AIR REGULATOR	1

PARTS LIST			
ITEM	PART NO.	DESCRIPTION	QTY
78	127.028	WASHER, LOCK INTERNAL STAR #10	2
79	167.190	MISTER SPRAY UNIT	1
80	252.190	VALVE BODY	1
81	256.028	MACHINE SCREW #10-32 X 3/8	4
82	342.096	ELBOW, PUSH IN (M) 1/4NPT 1/4 TUBE	2
83	379.096	ELBOW, MALE 1/8NPT	2
84	460.268	HOSE	2
85	117	NIPPLE, CLOSE 1/4NPT X 1-1/2	1
86	283	TEE, 1/4NPT BRASS	1
87	4266	HHCS #10-24 X 1-1/2	1
88	4570	NUT, HEX #10-24	1
89	701	1/2 NPT CONDUIT LOCKNUT	4
90	1204	FLANGED SPADE TERMINAL	9
91	11859	CONNECTOR ELEC 3 WIRES	1
92	12467	CONNECTOR , ELEC 5 WIRES	2
*	5.964	DRIVESHAFT ASSY (INCLUDES ITEMS *)	1
**	31.034	COUPLER COMPLETE (INCLUDES ITEMS **)	1
	28.816	FILE	1
	10756	3/32" HEX ALLEN WRENCH	1
	10757	1/8" HEX ALLEN WRENCH	1
	10758	5/32" HEX ALLEN WRENCH	1
	10759	3/16" HEX ALLEN WRENCH	1
	10760	1/4" HEX ALLEN WRENCH	1
REF	4244	DECAL - DANGER	1
REF	4634	DECAL - IMPORTANT	1
REF	1701	DECAL - PSI	1
REF	4773	DECAL - PARTS & SERVICE	1
REF	4712	DECAL - TRACTION WEAR RIDE	2
REF	4716	DECAL - IDENTIFICATION	2
REF	4772	DECAL - HUB INFLATE	1





TIRE SERVICE INTERNATIONAL

**WHEEL HOLDING ADAPTER  
REPAIR PARTS LIST  
REV 10-12-15**

<u>PART#</u>	<u>QTY</u>	<u>DESCRIPTION</u>
<b>SSG #30901</b>		<b>20" Dayton Adapter</b>
203.033	(1)	20" Cast Adapter Plate
218.028	(3)	Set Screw 1/2-13 x 3
40.489	(3)	Shaft Guide
50.013	(3)	Lock Bar
26.055	(3)	Nut Hex 1/2.13
<b>SSG #31901</b>		<b>22" Dayton Adapter</b>
206.033	(1)	22" Cast Adapter Plate
218.028	(3)	Set Screw 1/2-13 x 3
40.489	(3)	Shaft Guide
50.013	(3)	Lock Bar
26.055	(3)	Nut, Hex 1/2-13
<b>SSG #32901</b>		<b>24" Dayton Adapter</b>
207.033	(1)	24" Cast Adapter Plate
218.028	(3)	Set Screw 1/2-13 x 3
40.489	(3)	Shaft Guide
50.013	(3)	Lock Bar
26.055	(3)	Nut, Hex 1/2-13

**BUDD WHEEL ADAPTERS**

<b>SSG #33901</b>		<b>11.25 x 10</b>
79.038	(1)	Cast Adapter Plate (REF. Casting Dwg 205.033)
1373	(5)	Wheel Stud 1-1/8
1374	(5)	Nut, Wheel 1-1/8
748	(5)	Cap Screw 3/4-16
<b>SSG #39901</b>		<b>8.75 x 10</b>
4786	(1)	Cast Adapter Plate
1373	(5)	Wheel Stud 1-1/8
1374	(5)	Nut, Wheel 1-1/8
748	(5)	Cap Screw 3/4-16

<u>PART#</u>	<u>QTY</u>	<u>DESCRIPTION</u>
<b>SSG #42901</b>		<b>285.75mm x 10 Unimount</b>
4789	(1)	Cast Adapter Plate
4722	(5)	Stud 1-8 x 4 Pl.
747	(15)	Nut, 1-8 Hex Jam Pl.
<b>SSG #43901</b>		<b>335 mm x 10 Unimount</b>
4788	(1)	Cast Adapter Plate
4722	(5)	Stud 1-8 x 4 Pl.
747	(15)	Nut, 1-8 Hex Jam Pl.
<b>SSG #47901</b>		<b>8 x 5</b>
4787	(1)	Cast Adapter Plate
1836	(15)	Nut, 3/4-16 Hex Jam
4777	(5)	Set Screw 3/4-16 x 4



***WHEEL HOLDING ADAPTER  
REPAIR PARTS LIST  
10-12-15***

<b><u>PART#</u></b>	<b><u>QTY</u></b>	<b><u>DESCRIPTION</u></b>
<b>SSG #45901</b>	<b>8.75 x 6</b>	
4790	(1)	Cast Adapter Plate
3672	(9)	Nut, 3/4-16 Hex Jam
4777	(3)	Set Screw 3/4-16 x 4
<b>SSG #41901</b>	<b>7.25 x 6</b>	
4791	(1)	Cast Adapter Plate
4776	(3)	Cap Screw 5/8-11 2 1/2
630	(6)	Nut, Hex Jam 5/8-11
<b>SSG #34901</b>	<b>275mm x 8</b>	
4792	(1)	Cast Adapter Plate
4777	(4)	Set Screw 3/4-16 x 4
3672	(8)	Nut 3/4-16 Hex Jam
10151	(4)	Nut, Wheel Tapered 3/4-16
4722	(4)	Stud 1-8 x 4 Pl.
747	(12)	Nut 1-8 Hex Jam Pl.
<b>SSG #48901</b>	<b>6.5 x 8</b>	
4793	(1)	Cast Adapter Plate
4776	(4)	Cap Screw 5/8-11 x 2 1/2
630	(8)	Nut, Hex Jam 5/8-11
<b>SSG #40901</b>	<b>225mm x 8</b>	
10534	(1)	Cast Adapter Plate
218.028	(4)	Set Screw 1/2-13 x 3
26.055	(4)	Nut, Hex 1/2-13

**EXPANDING RIMS**

8410	(1)	Expanding Rim 13-16 x 6.375
8510	(1)	Expanding Rim 13-16 x 8.00
9410	(1)	Expanding Rim 14-17 x 7.125
10410	(1)	Expanding Rim 17-20 x 8.25
11410	(1)	Expanding Rim 20-22.5 x 9.00
12410	(1)	Expanding Rim 22-24.5 x 9.00
13410	(1)	Expanding Rim 20-22.5 x 11.75
14410	(1)	Expanding Rim 22-24.5 x 13.375
141710	(1)	Expanding Rim 14-17 x 10
172010	(1)	Expanding Rim 17-20 x 10

**ADAPTERS**

78.038	(1)	Inner Adapter
77.038-13	(1)	Outer Adapter
77.038	(1)	Outer Adapter





TIRE SERVICE  
INTERNATIONAL

Wheel Holding Adapters  
Repair Parts

10-9-15

DAYTON ADAPTERS

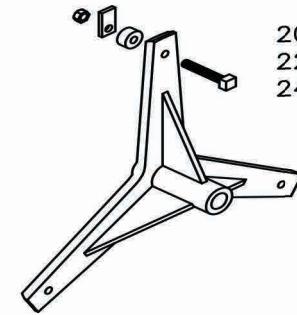

20" PN 30901  
22" PN 31901  
24" PN 32901

BUDD ADAPTERS  
COMPLETE ASSEMBLY

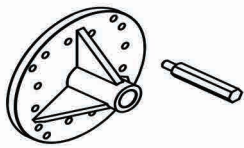

6.56 X 4  
170mm X 4  
180mm X 4  
8.25 X 4  
225mm X 4  
225 X 3 (10 Lug)  
1/2-20 HEX STUD  
6367K

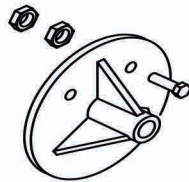

6.5 X 8  
5/8 STUD  
48901

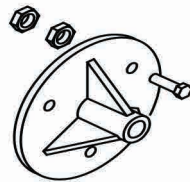

7.25 X 6  
5/8 STUD  
41901

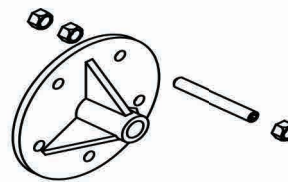

8 X 5  
3/4 STUD  
47901

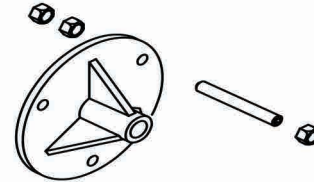

8.75 X 6  
3/4 STUD  
45901

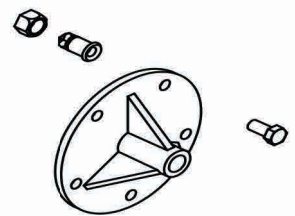

8.75 X 10  
1-1/8 STUD  
39901

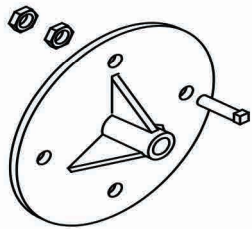

225mm X 8  
1/2 STUD  
40901

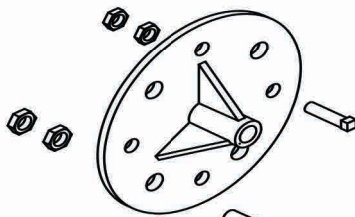

275mm X 8  
3/4 & 1 STUD  
34901

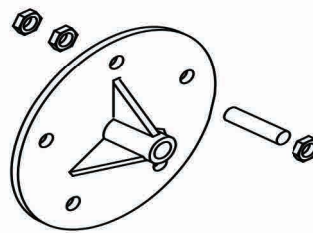

285.75 X 10  
1" STUD  
42901

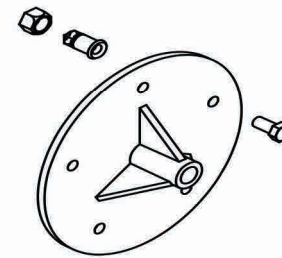

11.25 X 10  
1-1/8 STUD  
39901

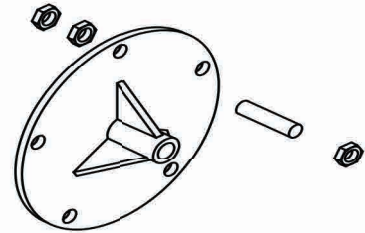

335mm X 10  
1" STUD  
43901

EXPANDING RIMS

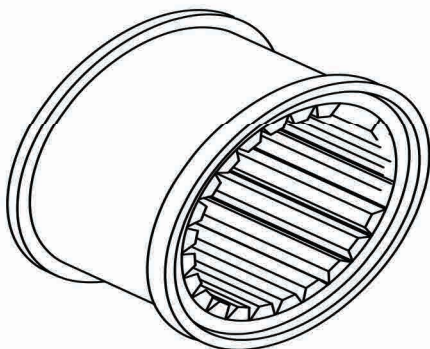

8.410	13-16 X	6.375
8.510	13-16 X	8.0
9.410	14-17 X	7.50
10.410	17-20 X	8.125
11.410	20-22.5 X	9.00
12.410	22-24.5 X	9.00
13.410	20-22.5 X	11.75
14.710	14-17 X	10
172010	17-20 X	10

CONE ADAPTERS



INNER ADAPTER  
78.038



OUTER ADAPTER  
77.038-13



OUTER ADAPTER  
77.038

UPA ADAPTERS



INNER ADAPTER  
78.038



OUTER ADAPTER  
77.038