

# BLASTING MATS AND ACCESSORIES.

B2B Industrial, Inc's product booklet, includes marketing tear sheets for our blasting mat product range, our blasting mat accessories and services.



[www.b2bii.com](http://www.b2bii.com)



1 (877) 456-6768

# B2B MATS.

- 05.** The Armadillo
- 06.** The Armadillo XTR HD
- 07.** The Rhino
- 08.** The Rhino XTR HD
- 09.** The Manta
- 010.** The Tiger
- 011.** The Elephant
- 012.** The Rail Renegade
- 013.** The Rhino Skin
- 014.** The Gator
- 015.** The Bushmaster

# PRODUCTS.

- 017.** The Crab Hook
- 018.** The Mat Bat
- 019.** Cobra Rings
- 020.** Gorilla Weight
- 021.** Mantis Clamp
- 022.** Trough
- 023.** Polar Plow

# SERVICES.

**025.** The Forrest Cloud

**026.** The Fleet Review

# PATENTS.

**028.** Canadian Patent

**029.** American Patent(s)

**033.** MSDS Sheet



# **BLASTING MAT PRODUCT RANGE.**

Included in this section: Armadillo, Armadillo XTR  
HD Rhino, Rhino XTR HD, Manta, Tiger, Elephant, Rail  
Renegade, Rhino Skin, Gator Wharf and Bushmaster.



# THE ARMADILLO MAT.

## Our Most Popular Mat Design.

### PRODUCT FEATURES/DESCRIPTION

The Armadillo Mat is our most popular mat design! It is built with our patented "smile-frown" tire pattern and is deployable in numerous applications.

- ✓ Multiple sizing options.
- ✓ Multiple cable options.
- ✓ Multiple ring sizes.
- ✓ Car tire mat.
- ✓ "Patented" smile-frown pattern.
- ✓ Customizable.

The Armadillo Mat is best deployable in construction and blasting environments, and excels at releasing a high volume of high velocity blast gases to minimize the height that the mat rises into the air after the blast.

This mat can also act as an access matting solution for temporary roadways, or be used in marshlands/swamps to help large scale machinery to access job sites.

B2B Industrial, Inc. manufactures only quality products that are **"Built2Blast"**.

🍁 Proudly Manufactured in Canada.  
 USA Patent No.: US 10,739,121 B2  
 Canadian Patent No.: 3 040 991



WWW.B2BII.COM FOR A VALUE PROPOSITION  
 CALL OUR CANADIAN AND USA NUMBERS AT  
 CA | 1 (877) 456-6768 • US | 1 (888) 823-5007

**B2B**  
 Industrial, Inc.

# ARMADILLO XTR HD.

## The Armadillo's Heavy Duty Alternative.

### PRODUCT FEATURES/DESCRIPTION

The Armadillo XTR HD Mat is the heavier duty counterpart to our most popular mat design! It is built with our patented "smile-frown" tire pattern and is deployable in numerous applications.

- ✓ Multiple sizing options.
- ✓ Multiple cable options.
- ✓ Multiple ring sizes.
- ✓ Heavy duty car tire mat.
- ✓ "Patented" smile-frown pattern.
- ✓ Customizable.

The Armadillo XTR HD Mat is best deployable in more demanding construction and heavier blasting environments; it excels best at releasing a high volume of high velocity blast gases to minimize the height the mat rises into the air after the blast.

This mat can also act as an access matting solution for temporary roadways, or be used in marshlands/swamps to help large scale machinery to access job sites.

B2B Industrial, Inc. manufactures only quality products that are **"Built2Blast"**.



Proudly Manufactured in Canada.  
USA Patent No.: US 10,739,121 B2  
Canadian Patent No.: 3 040 991



WWW.B2BII.COM FOR A VALUE PROPOSITION  
CALL OUR CANADIAN AND USA NUMBERS AT  
CA | 1 (877) 456-6768 • US | 1 (888) 823-5007

**B2B**  
Industrial, Inc.

# THE RHINO MAT.

## Our Second Most Popular Mat Design.



### PRODUCT FEATURES/DESCRIPTION

The Rhino Mat is our second most popular mat design! This mat is tough and is deployable in heavy duty construction environments.

- ✓ Multiple sizing options.
- ✓ Multiple cable options.
- ✓ Multiple ring sizes.
- ✓ Tractor trailer tire mat.
- ✓ "Patented" variable density build.
- ✓ Customizable.

The Rhino Mat is best known for its durability in heavy duty construction and blasting environments. However, these mats are still versatile enough to use as high velocity shooting range products and blasting curtains.

This mat is B2B Industrial, Inc's gold standard for tough durable blasting mats, boasting incredible durability while remaining versatile, living up to our built to blast mentality.

B2B Industrial, Inc. manufactures only quality products that are **"Built2Blast"**.



Proudly Manufactured in Canada.  
USA Patent No.: US 10,739,121 B2  
Canadian Patent No.: 3 040 991

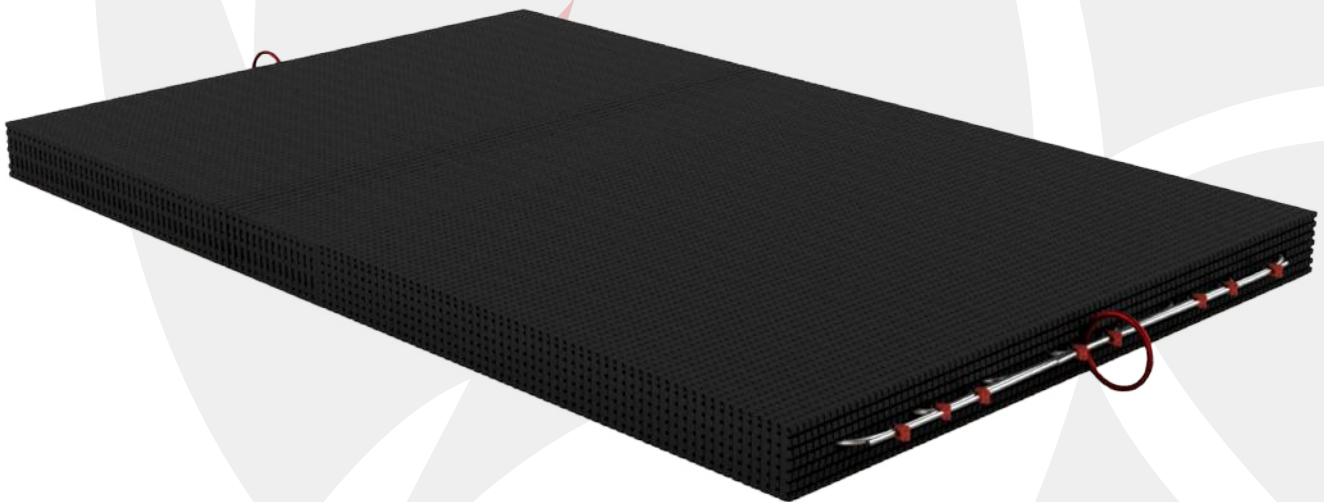

WWW.B2BII.COM FOR A VALUE PROPOSITION  
CALL OUR CANADIAN AND USA NUMBERS AT  
CA | 1 (877) 456-6768 • US | 1 (888) 823-5007

**B2B**  
Industrial, Inc.

# RHINO XTR HD.

## The Rhino's Heavy Duty Alternative.

### PRODUCT FEATURES/DESCRIPTION

The Rhino XTR HD Mat is the heavier duty counterpart to our second most popular mat design! This mat is tough and is deployable in heavy duty construction environments.

- ✓ Multiple sizing options.
- ✓ Multiple cable options.
- ✓ Multiple ring sizes.
- ✓ Heavy duty tractor trailer tire mat.
- ✓ "Patented" variable density build.
- ✓ Customizable.

The Rhino Mat is best known for its durability in heavy duty construction and blasting environments. However, the Rhino XTR HD Mat takes it to another level. These mats are designed for heavy civil work and have been tested to support over 6 million lbs.

This mat is B2B Industrial, Inc's gold standard for tough durable civil mats, boasting outstanding durability while remaining versatile, living up to our built to blast mentality.

B2B Industrial, Inc. manufactures only quality products that are **"Built2Blast"**.

🍁 Proudly Manufactured in Canada.  
USA Patent No.: US 10,739,121 B2  
Canadian Patent No.: 3 040 991

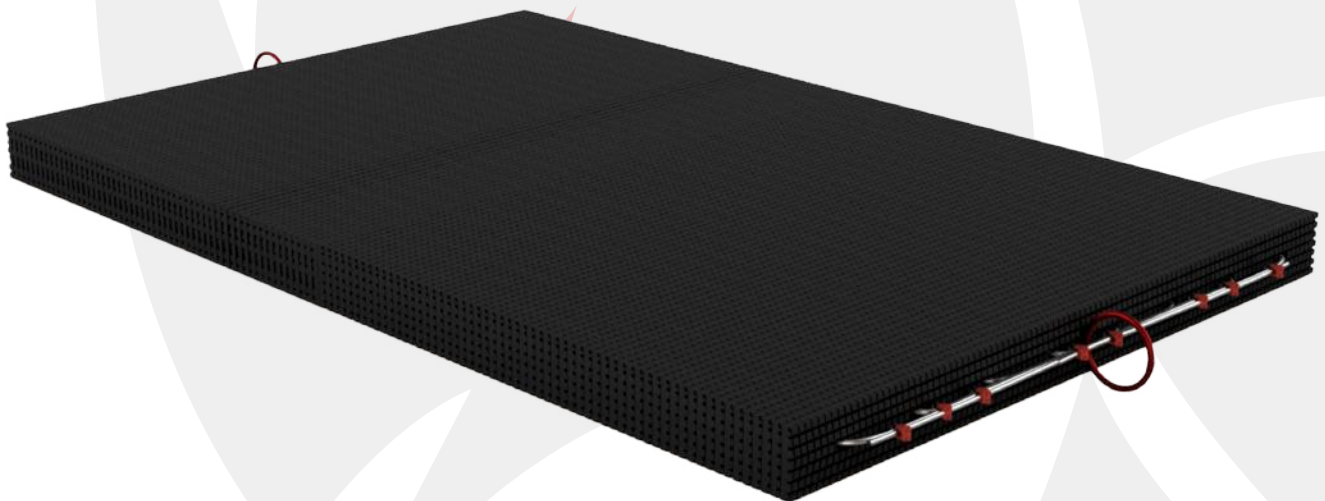

WWW.B2BII.COM FOR A VALUE PROPOSITION  
CALL OUR CANADIAN AND USA NUMBERS AT  
CA | 1 (877) 456-6768 • US | 1 (888) 823-5007

**B2B**  
Industrial, Inc.



# THE MANTA MAT.

## Our Lightest, Most Flexible Mat Design.

### PRODUCT FEATURES/DESCRIPTION

The Manta Mat is our lightest, and most flexible mat design! This mat is best suited for environments that require a lighter solution.

- ✓ Multiple sizing options.
- ✓ Multiple cable options.
- ✓ Wire rope lifting apparatus.
- ✓ Tractor trailer tire mat.
- ✓ "Patented" multi-layer design.
- ✓ Customizable.

Despite it's size and weight, the Manta Mat is known for its durability in heavy duty construction and blasting environments. However, these mats can go where our heavier duty options just can't.

The Manta is the perfect solution for smaller blasting jobs, low profile access roadways, or blast curtains. All for a fraction of the price you'd pay for a heavier duty matting option.

B2B Industrial, Inc. manufactures only quality products that are **"Built2Blast"**.



Proudly Manufactured in Canada.  
USA Patent No.: US 11,585,647 B2



WWW.B2BII.COM FOR A VALUE PROPOSITION  
CALL OUR CANADIAN AND USA NUMBERS AT  
CA | 1 (877) 456-6768 • US | 1 (888) 823-5007

**B2B**  
Industrial, Inc.



# THE TIGER MAT.

## Our Most Versatile Mat Design.

### PRODUCT FEATURES/DESCRIPTION

The Tiger Mat is our most versatile mat design! This mat is infinitely customizable and is deployable in numerous applications.

- ✓ Multiple sizing options.
- ✓ Multiple cable options.
- ✓ Multiple ring sizes.
- ✓ Multiple tire pattern options.
- ✓ Car tire and tractor trailer tire mat.
- ✓ "Patented" variable density build.
- ✓ Highly customizable.

The Tiger Mat is best known for its versatility; these mats are able to take on the shape and size of the job at hand! The mat excels at blast mitigation, debris protection, roadways, and as a blast curtain to name a few.

This mat is B2B Industrial, Inc's gold standard for versatile blasting mats, boasting incredible shape-shifting abilities, able to adapt to whatever you throw at it.

B2B Industrial, Inc. manufactures only quality products that are **"Built2Blast"**.

 Proudly Manufactured in Canada.  
USA Patent No.: US 10,739,121 B2  
Canadian Patent No.: 3 040 991

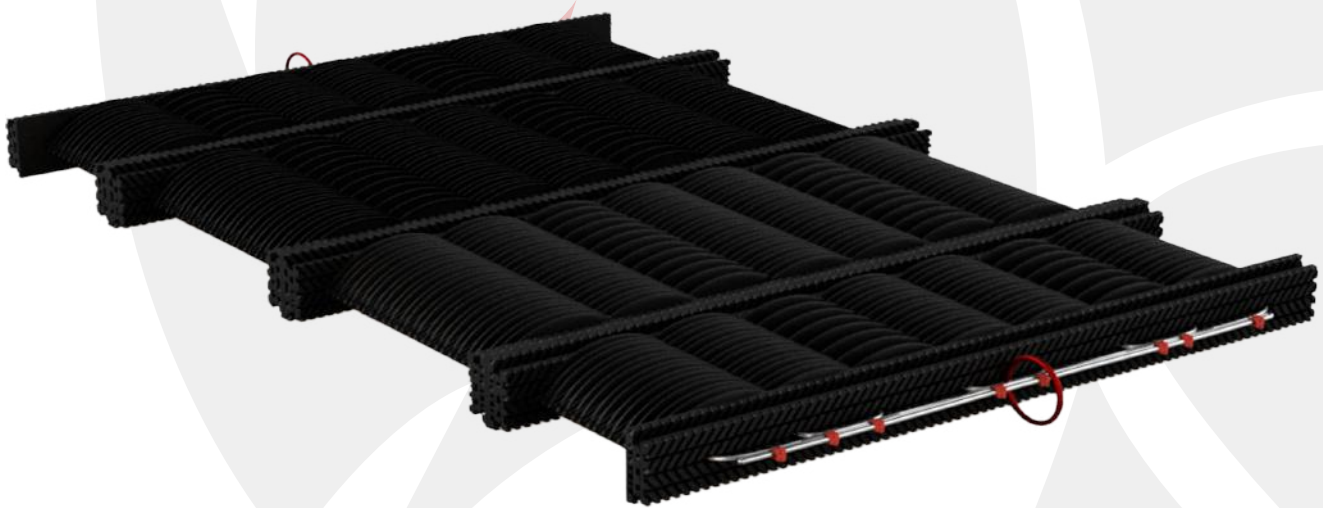

**WWW.B2BII.COM FOR A VALUE PROPOSITION**  
**CALL OUR CANADIAN AND USA NUMBERS AT**  
**CA | 1 (877) 456-6768 • US | 1 (888) 823-5007**





# THE ELEPHANT MAT.

## Our Heaviest, Most Durable Mat Design.

### PRODUCT FEATURES/DESCRIPTION

The Elephant Mat is our heaviest, and most durable mat design! This mat is best deployable in heavy construction and blasting environments.

- ✓ Multiple sizing options.
- ✓ Multiple cable options.
- ✓ Multiple ring sizes.
- ✓ Super single tire mat.
- ✓ "Patented" variable density build.
- ✓ Customizable.

The Elephant Mat is known for its durability in heavy duty construction and blasting environments. These mats are a force to be reckoned with and can endure practically anything you can throw at them.

This mat is B2B Industrial, Inc's gold standard for tough durable blasting mats, boasting incredible durability and overall weight, living up to our built to blast mentality

B2B Industrial, Inc. manufactures only quality products that are **"Built2Blast"**.

🍁 Proudly Manufactured in Canada.  
USA Patent No.: US 10,739,121 B2  
Canadian Patent No.: 3 040 991



**WWW.B2BII.COM FOR A VALUE PROPOSITION**  
**CALL OUR CANADIAN AND USA NUMBERS AT**  
**CA | 1 (877) 456-6768 • US | 1 (888) 823-5007**





# THE RAIL RENEGADE.

## The Tiger Mat's Closest Relative.

### PRODUCT FEATURES/DESCRIPTION

Although our mats are known for being "Built2Blast" they are certainly no slouch when it comes to application within other industries.

- ✓ Minimizes machine wobble.
- ✓ Balance.
- ✓ Multiple angle rail protection.
- ✓ Multiple tire pattern options.
- ✓ Car tire and tractor trailer tire mat.
- ✓ "Patented" variable density build.
- ✓ Highly customizable.

The Rail Renegade Mat is custom manufactured and designed for each clients individual needs, allowing operators of heavy equipment access to rail work, right on the rails.

These "Patented" mats are built using our looping design while taking advantage of our Chameleon mat DNA allowing our mats the ability to be set down and fit like a glove while the excavator moves over top of them.

B2B Industrial, Inc. manufactures only quality products that are "Built2Blast".

 Proudly Manufactured in Canada.  
USA Patent No.: US 10,739,121 B2  
Canadian Patent No.: 3 040 991



**WWW.B2BII.COM FOR A VALUE PROPOSITION**  
**CALL OUR CANADIAN AND USA NUMBERS AT**  
**CA | 1 (877) 456-6768 • US | 1 (888) 823-5007**



# THE RHINO SKIN MAT.

## Our Most Advanced Mat Design.

### PRODUCT FEATURES/DESCRIPTION

The Rhino Skin Mat is our most advanced mat design to date! The first of its kind in the industry, boasting a multi-composite layer design.

- ✓ Extremely lightweight.
- ✓ Extremely flexible.
- ✓ Extremely versatile.
- ✓ Composite material.
- ✓ "Patented" multi-layer design.
- ✓ Highly customizable.

The Rhino Skin is best known for its versatility through our layered design, customers have access to a myriad of composite material combinations creating a durable, yet flexible mat.

Despite it's thin appearance, this mat is extremely tough, and is able to not only survive, but thrive in heavy construction and blasting environments without sacrificing any product portability.

B2B Industrial, Inc. manufactures only quality products that are **"Built2Blast"**.

🍁 Proudly Manufactured in Canada.  
USA Patent No.: US 11,585,647 B2  
Canadian Patent No.: Pending

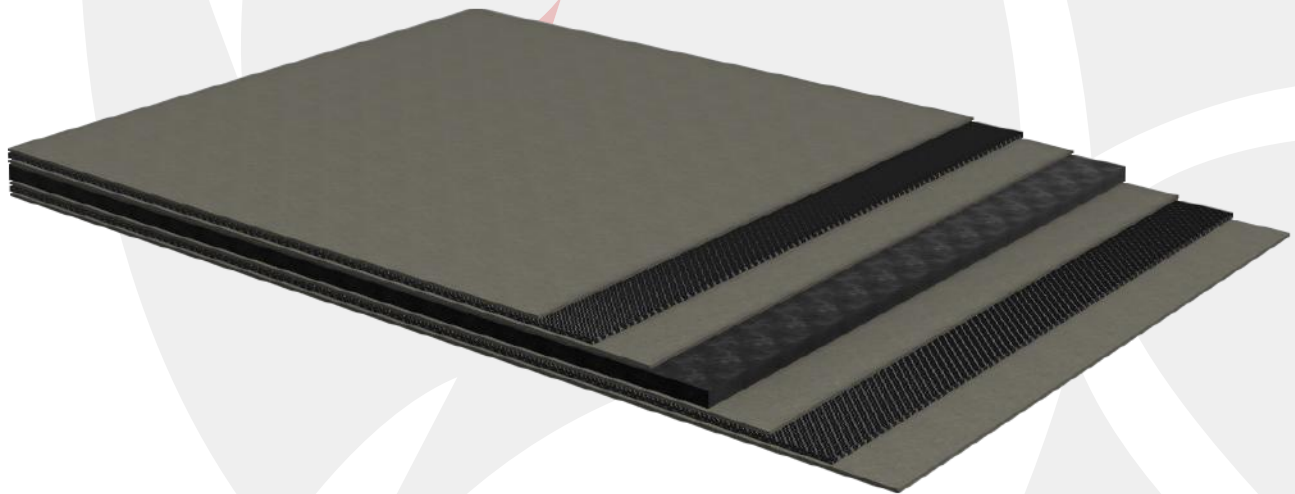

WWW.B2BII.COM FOR A VALUE PROPOSITION  
CALL OUR CANADIAN AND USA NUMBERS AT  
CA | 1 (877) 456-6768 • US | 1 (888) 823-5007





# THE GATOR MAT.

## Our Marine Wharf Mat Design.

### PRODUCT FEATURES/DESCRIPTION

The Gator Wharf Mat was designed to be used as a protective barrier to ensure any vessels snug up to the wharf undamaged.

- ✓ Multiple sizing options.
- ✓ Multiple cable options.
- ✓ Multiple ring sizes.
- ✓ Tractor trailer tire tread mat.
- ✓ Galvanized clamps and cables.
- ✓ Customizable.

Our wharf bumper mat design ensures maximum protection for incoming ships. Built with galvanized cable, and clamps, the Gator Wharf Mat is our newest heavy duty "patented" mat solution designed specifically for the marine industry.

With customizable sizing, the Gator Wharf Mat is equipped to handle a wide variety of applications and incoming ships.

B2B Industrial, Inc. manufactures only quality products that are **"Built2Blast"**.

 Proudly Manufactured in Canada.  
USA Patent No.: US 10,739,121 B2  
Canadian Patent No.: 3 040 991

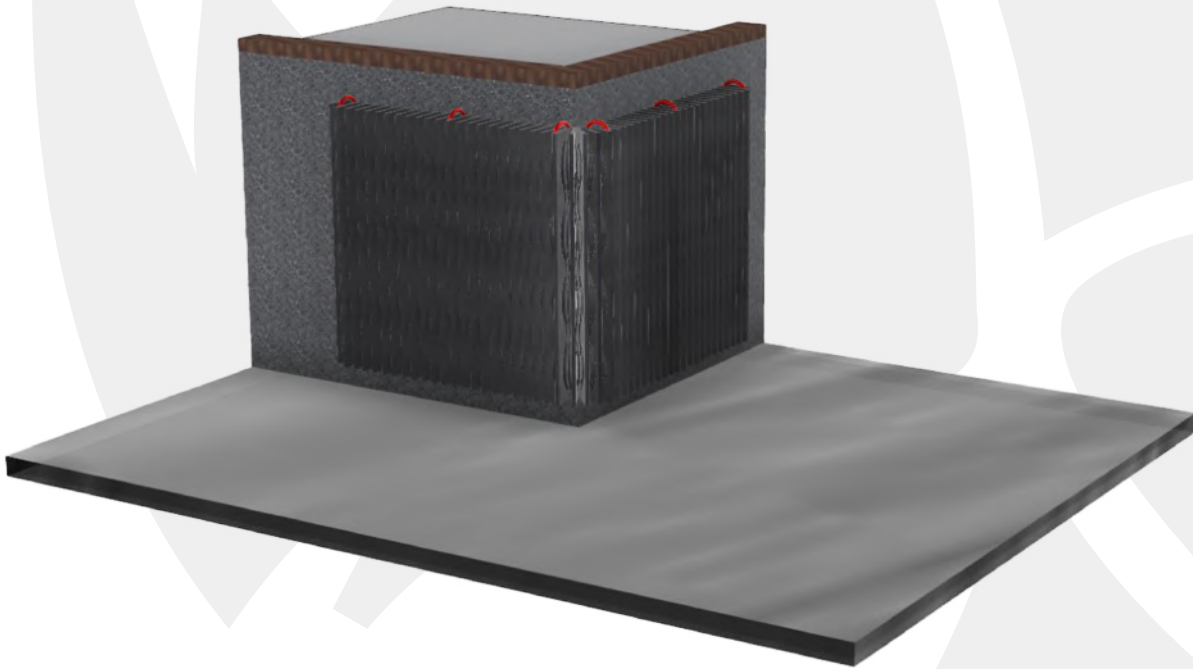

**WWW.B2BII.COM FOR A VALUE PROPOSITION**  
**CALL OUR CANADIAN AND USA NUMBERS AT**  
**CA | 1 (877) 456-6768 • US | 1 (888) 823-5007**





# THE BUSHMASTER.

## Our Grading/Clearing Drag Mat.

### PRODUCT FEATURES/DESCRIPTION

The Bushmaster is the Armadillo mats closest cousin, with the primary task of grading and clearing roads in the most grueling conditions.

- ✓ Multiple sizing options.
- ✓ Multiple cable options.
- ✓ Car tire mat.
- ✓ "Patented" smile-frown pattern.
- ✓ Customizable.

The Bushmasters capability to excel in any scenario boils down to the mats customize-ability. The Bushmaster is able to be manufactured in multiple sizes enabling you to tackle your companies specific use case.

The Bushmaster is capable of application across all four seasons, whether you are grading a path of gravel or snow, clearing brush, or widening a road.

B2B Industrial, Inc. manufactures only quality products that are **"Built2Blast"**.

 Proudly Manufactured in Canada.

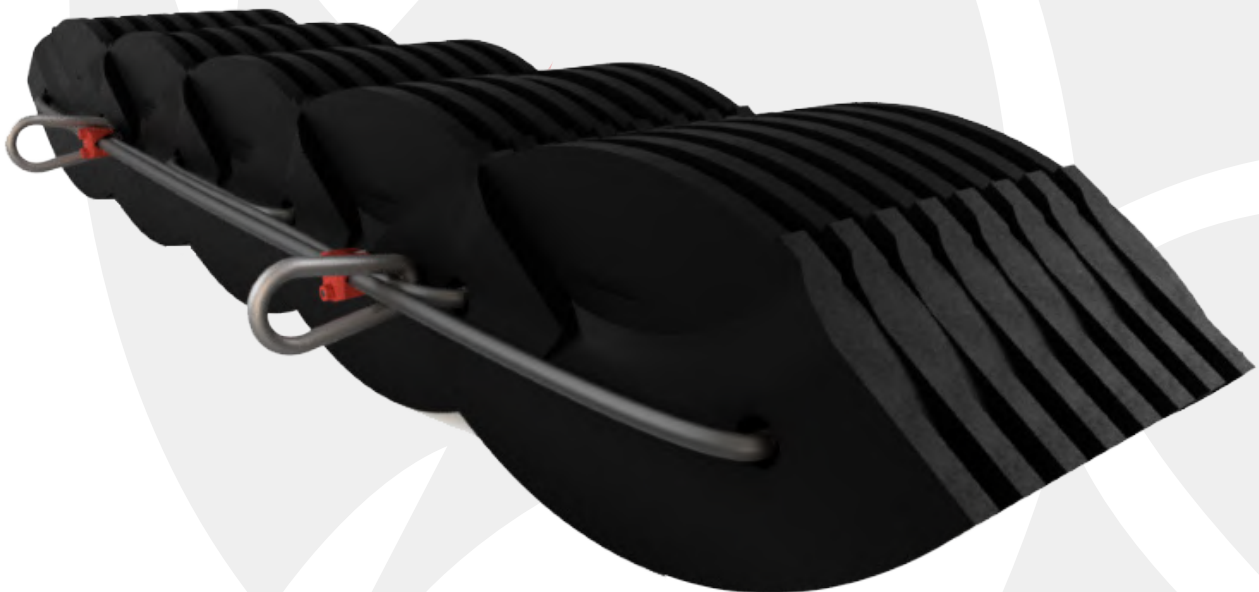

**WWW.B2BII.COM FOR A VALUE PROPOSITION  
CALL OUR CANADIAN AND USA NUMBERS AT  
CA | 1 (877) 456-6768 • US | 1 (888) 823-5007**



# **BLASTING MAT ACCESSORIES.**

Included in this section: Crab Hook, Mat Bat, Cobra Ring, Gorilla Weight, Mantis Clamp, Trough and Polar Plow.





# THE CRAB HOOK.

## Our Mat Suspension Cable and Hook.



### PRODUCT FEATURES/DESCRIPTION

The Crab Hook is our mat suspension cable and hook! This is a perfect quality of life improvement for making short work of fleet mobilization.

- ✓ Multiple cable options.
- ✓ Ease of use.
- ✓ Extremely flexible.
- ✓ Extremely versatile.
- ✓ Extremely lightweight.
- ✓ Exceptionally strong grip.

Moving a couple thousand pounds is no easy feat, even with machinery. B2B Industrial, Inc. makes this easier with our newest blasting mat accessory.

The Crab hook is a light weight cable and hook set up, designed for the purpose of giving your workers a more efficient way of mobilizing your blasting mat fleets. The Crab Hook can also be utilized to suspend mats as a curtain solution.

B2B Industrial, Inc. manufactures only quality products that are **"Built2Blast"**.

 Proudly Manufactured in Canada.



WWW.B2BII.COM FOR A VALUE PROPOSITION  
CALL OUR CANADIAN AND USA NUMBERS AT  
CA | 1 (877) 456-6768 • US | 1 (888) 823-5007



# THE MAT BAT GPS.

## Our Blasting Mat GPS Tracker.



### PRODUCT FEATURES/DESCRIPTION

The Mat Bat is our advanced blasting mat GPS tracker! The first of its kind in the industry, boasting real-time tracking of your mat fleet.

- ✓ Extremely lightweight.
- ✓ Extremely rugged casing.
- ✓ Accurately track and manage your blasting mat fleet.
- ✓ GPS location services allows movement logistics.
- ✓ Highly affordable.

The Mat Bat is best known for its rugged casing, durability, and the ability to track the logistics of your companies blasting mat fleet with real time metrics.

It blends seamlessly into our products, remaining discrete, so once you set it, you can simply forget it. The Mat Bat is compatible with practically every B2B Industrial, Inc. product, and will ensure you always have eyes on your fleet.

B2B Industrial, Inc. manufactures only quality products that are **"Built2Blast"**.

 Proudly Manufactured in Canada.



WWW.B2BII.COM FOR A VALUE PROPOSITION  
CALL OUR CANADIAN AND USA NUMBERS AT  
CA | 1 (877) 456-6768 • US | 1 (888) 823-5007





# THE COBRA RING.

## Our Tractor Trailer Tire Sidewall Ring.

### PRODUCT FEATURES/DESCRIPTION

The Cobra Ring is our sidewall ring design! The Cobra is cut and stacked to ensure your road cones stay put once they are placed down.

- ✓ No water collection.
- ✓ Easily deployable.
- ✓ Data acquisition source.
- ✓ Extremely affordable.
- ✓ Near indestructible design.
- ✓ Guaranteed to last for five years, or B2B will replace them.

The Cobra is an agricultural ring, single cone construction ring a new data gathering device for silage in the agricultural business, and a smaller scaled weight, all wrapped in one.

The Cobra's weigh roughly 23lbs a piece granting them versatility in their application while retaining durability. Data gathering is able to determine temperatures, etc in silage, other areas, pressures, and gases.

B2B Industrial, Inc. manufactures only quality products that are **"Built2Blast"**.

 Proudly Manufactured in Canada.

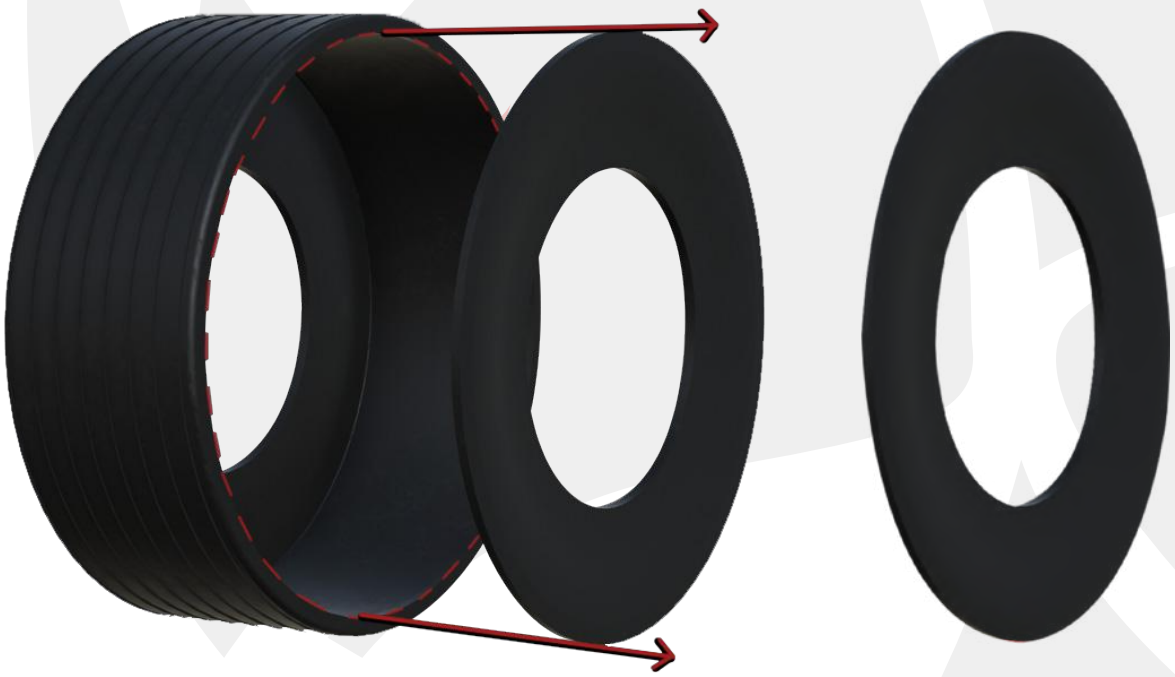

**WWW.B2BII.COM FOR A VALUE PROPOSITION**  
**CALL OUR CANADIAN AND USA NUMBERS AT**  
**CA | 1 (877) 456-6768 • US | 1 (888) 823-5007**



# THE GORILLA WEIGHT.

## Our Large Scale OTR Tire Weight.



### PRODUCT FEATURES/DESCRIPTION

The Gorilla Weight is our large scale OTR tire weight! This product is the perfect companion for our vast range of blasting mat products.

- ✓ Multiple sizes - 4ft, 6ft, 8ft, 9ft.
- ✓ Practically indestructible.
- ✓ Cost effective solution.
- ✓ Mat Bat compatible product.
- ✓ Blasting mat weight enhancer.
- ✓ Customizable.

The Gorilla Weight is best known for its extreme durability and added weight to lighter matting solutions. The weight is best paired with our Manta Mats, and our Rhino Skin Mats creating a more cost effective solution.

The Gorilla Weight is far from just a large weight, these are able to be used as smaller wharf bumpers, or they can be modified to be built into a temporary wall or barrier.

B2B Industrial, Inc. manufactures only quality products that are **"Built2Blast"**.

 Proudly Manufactured in Canada.



WWW.B2BII.COM FOR A VALUE PROPOSITION  
CALL OUR CANADIAN AND USA NUMBERS AT  
CA | 1 (877) 456-6768 • US | 1 (888) 823-5007





# THE MANTIS CLAMP.

## Our Blasting Mat Cable Repair Kit.

### PRODUCT FEATURES/DESCRIPTION

The Mantis Clamp is our field cable repair kit! This is a simple set and forget fix to mend any damaged or worn cables used in your blast mats.

- ✓ Reduced downtime.
- ✓ Saves you time and money.
- ✓ Cost effective solution.
- ✓ Simple installation.
- ✓ Exceptionally strong grip.
- ✓ Multiple lengths.

The last thing you want to deal with on your job site is a damaged or broken cable. Our clamp solution has exceptional grip strength, and once your cable has been repaired with the Mantis Clamp you are free to forget about it and continue working.

Using angled screw holes machined on the outside of its tapered cylindrical design, the clamp sinks its teeth into the cable and doesn't let go.

B2B Industrial, Inc. manufactures only quality products that are **"Built2Blast"**.

 Proudly Manufactured in Canada.

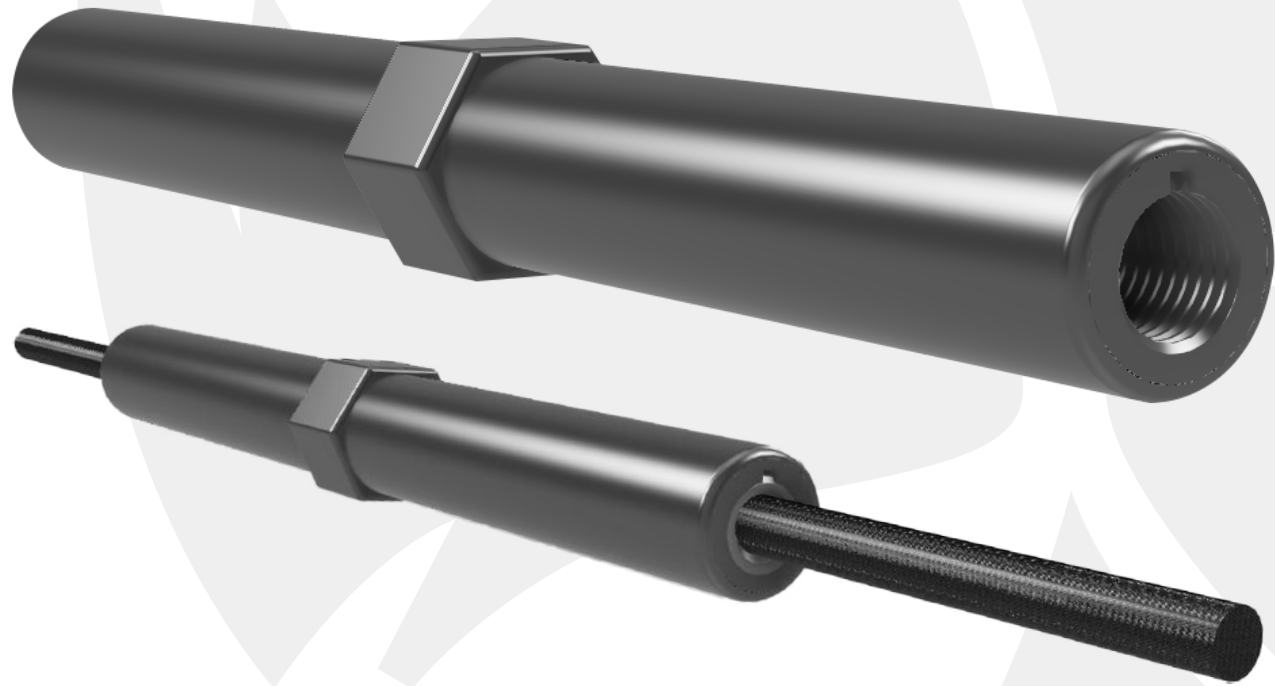

**WWW.B2BII.COM FOR A VALUE PROPOSITION  
CALL OUR CANADIAN AND USA NUMBERS AT  
CA | 1 (877) 456-6768 • US | 1 (888) 823-5007**



# THE OTR TROUGH.

## Our Near Indestructible OTR Design.



### PRODUCT FEATURES/DESCRIPTION

The OTR Trough is our near indestructible design! Our trough is built to get the job done right. Once it is placed, it isn't going anywhere.

- ✓ Extremely durable.
- ✓ Extremely efficient.
- ✓ Extremely versatile.
- ✓ Extremely affordable.
- ✓ Near indestructible design.
- ✓ Large scale OTR tire design.
- ✓ Highly customizable.

B2B Industrial, Inc. re-purposes even the largest of tires!

The OTR Trough is a perfect example of why we re-purpose and recycle rubber, and the life that can be given back to an exhausted tire.

Boasting a nearly indestructible exterior, a section for water filtering and distribution, and the ability to add anchor points for simple relocation.

B2B Industrial, Inc. manufactures only quality products that are **"Built2Blast"**.

 Proudly Manufactured in Canada.

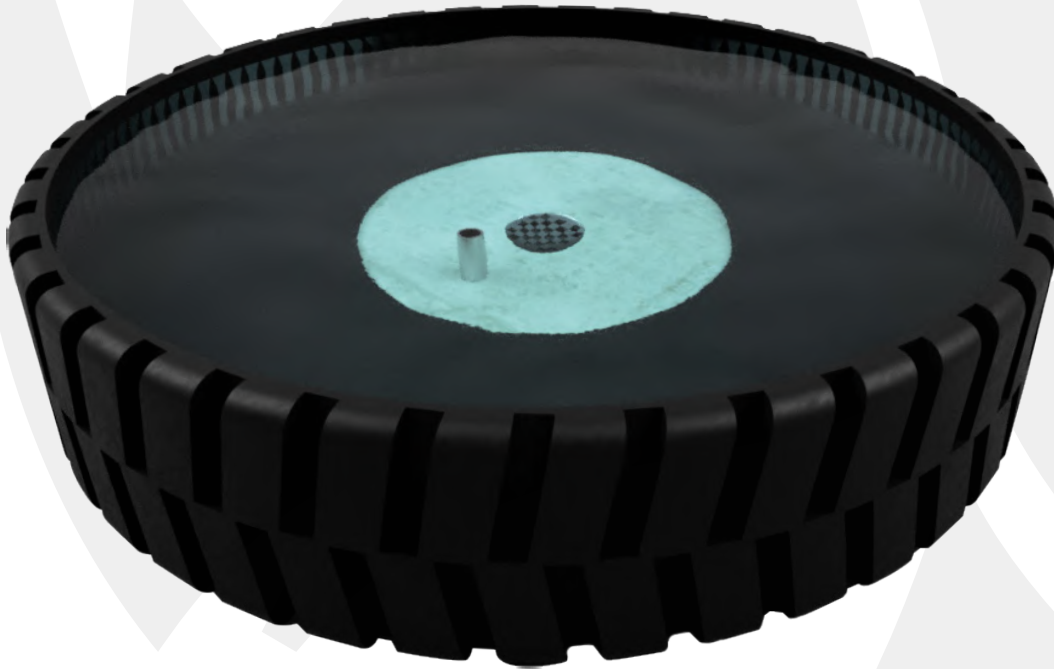

WWW.B2BII.COM FOR A VALUE PROPOSITION  
CALL OUR CANADIAN AND USA NUMBERS AT  
CA | 1 (877) 456-6768 • US | 1 (888) 823-5007



# THE POLAR PLOW.

## Our Near Indestructible OTR Design.



### PRODUCT FEATURES/DESCRIPTION

The Polar Plow is our OTR tire plow design! Our plow is built to get the job done right; from the thickest snow, to the finest sand and gravel.

- ✓ Extremely efficient.
- ✓ Extremely versatile.
- ✓ Extremely affordable.
- ✓ Near indestructible design.
- ✓ Large scale OTR tire design.
- ✓ Customizable for your machines! (John Deere, Kubota, etc.)

B2B Industrial, Inc. re-purposes even the largest of tires!

The Polar Plow is the perfect companion for a yard, parking lot, or job site that is just a bit too big for one person to take care of. The plow is easily mountable on the front of small machinery, or 4x4 vehicles, and designed with steel support beams ensuring the plow will maintain its concave shape.

B2B Industrial, Inc. manufactures only quality products that are **"Built2Blast"**.

 Proudly Manufactured in Canada.



**WWW.B2BII.COM FOR A VALUE PROPOSITION  
CALL OUR CANADIAN AND USA NUMBERS AT  
CA | 1 (877) 456-6768 • US | 1 (888) 823-5007**



# **B2B INDUSTRIAL PRODUCT SERVICES.**

Included in this section: Blasting Mat Fleet Review and  
Forrest Cloud.





# THE FLEET REVIEW.

## Our Blasting Mat Fleet Review Service.

### BENEFITS OF A FLEET REVIEW

The economics of proper ESG management can pay dividends to your firm. The mats your team requires to be safe and compliant should be reviewed on an on going basis and will change from year-to-year to adapt to your company's changing circumstances and blasting techniques. This may require change from year-to-year to adapt to your company's ever-changing needs. The idea that you should continue with something because "that's how it has always been" is not the way to optimize productivity.

A review of your fleet will help your team stay on top of what your company needs to thrive - safely, while also saving you money in the long run. You don't have to do it alone though. At B2B Industrial, Inc. we are here to guide you through the process.

## Be More Competitive This Year!

### 01. PLANNING

Being proactive with your Mat Fleet assets and procurement ensures you have what you need when you need it. There are other methods of procuring Blasting Mats that your team may not have considered. When you order with B2B II's exclusive BMAAS early, you have access to the widest selection of products available, meaning you only pay for what will work best for you, when you need it.

### 02. ORDERING CYCLES AND CURRENT STOCK AVAILABILITY

It's not just a free-for-all in terms of what you can get, working with a Fleet procurement/management partner helps you to understand the market ordering cycles, used mats, and market trends. Ordering at the right time will save you money and allow you to find the optimal fleet additions for your business.

### 03. HELPFUL ADVICE

Everything has a peak lifespan, including your Blasting Mat Fleet. We can help you evaluate when it's time to cycle out older Mats to maximize their value. B2B has a REFRESH Program, unique to the industry that can minimize mats in inventory.

### 04. INNOVATIVE SOLUTIONS

Our biggest goal, when working with a client, is to get them the best possible solution for them. Time, Effort and Money saved on your Blasting Mat Fleet are resources you can re-invest into growing your company. We can help maximize your annual fleet refreshes while identifying potential cost savings in your current Fleet. Low on cash flow? We can potentially arrange a lease by back of unencumbered Blasting Mats\*

### 05. RANGE OF ADDITIONAL SERVICES

We like to think of these as the bonuses to working together. We can help you with items like GPS options for asset tracking, Blasting Mat Fleet management and moves, potential on-site repair, repair materials... and the list goes on.



**WWW.B2BII.COM FOR A VALUE PROPOSITION**  
**CALL OUR CANADIAN AND USA NUMBERS AT**  
**CA | 1 (877) 456-6768 • US | 1 (888) 823-5007**



1001100100  
0100100000  
1101000110  
0110011100  
010100100  
011101000  
00000110  
0110  
000  
0011  
001001  
0111100  
000110  
011001  
01011  
01107  
1000  
1107  
110  
01  
00  
11  
07  
7



# THE FORREST CLOUD.

## Our Digital Storage Service.

### IMMUTABLE DATA STORAGE

Data is the oil of the 21st century. Companies are starting to realize that data availability/security plays an integral role in their business. The global average cost of cyber crimes was valued at \$6 trillion in 2021. Companies today either don't realize how serious a data loss can be for them, or are merely crossing their fingers hoping that no major outages don't happen on site.

Data recovery plans are highly important to any business, and are often overlooked as a critical assets. A recovery plan executed poorly can end in disaster. Forrest Cloud provides a highly accessible cloud storage solution that ensures your data is available when you need it.

Your data is your company's lifeline in the age of the digital world. Our data storage process can be broken down into four simple steps that ensure your data is not only being stored safely, but effectively, Making your data entirely immutable.

### HOW DOES THE FORREST CLOUD WORK?

- 01. **Application Data:** Your data is important, ensuring it's safety should be a business' top priority moving into the future. Data is selected to be stored.
- 02. **Data Encryption:** Files are broken up and encrypted using erasure coding, and the pieces are stored around the globe.
- 03. **Secure Data Storage:** Your encrypted data is collected, and is safely recorded and stored within the Forrest Cloud's multiple secure data center locations.
- 04. **Data Distribution and Recovery:** The original pieces of data will be retrieved, reassembled and transferred to the client's local machine.

### BENEFITS OF A CLOUD STORAGE SYSTEM?

**Storage Cost:** Installing tangible storage equipment gets expensive fast. Forrest Cloud handles all the maintenance for you behind the scenes, only charging a small monthly fee.

**Storage Redundancy:** A good rule of thumb is to never put all of your eggs into one basket. The further apart your data is, the better. B2B lets you spread every piece of data to over 80 storage providers across the globe.

**Storage Security:** Forrest Cloud offers E2EE (E2EE is optional for those who want a full hands off experience!) to guarantee you are the only one with access to your data. Once Forrest Cloud's end-to-end encryption (E2EE) is in place, your data is encrypted with a unique key that YOU create, ensuring no one else ever has access to your key.



WWW.B2BII.COM FOR A VALUE PROPOSITION  
CALL OUR CANADIAN AND USA NUMBERS AT  
CA | 1 (877) 456-6768 • US | 1 (888) 823-5007



# **B2B INDUSTRIAL PRODUCT PATENTS.**

Included in this section: Canadian Patent, American Patent(s), MSDS Sheet.





Innovation, Sciences et  
Développement économique Canada  
Office de la propriété intellectuelle du Canada

Innovation, Science and  
Economic Development Canada  
Canadian Intellectual Property Office

# Brevet canadien / Canadian Patent

3,040,991

*Numéro de brevet  
Patent number*

*Le commissaire aux brevets a accordé un brevet pour l'invention décrite dans le mémoire descriptif portant le numéro de brevet susmentionné. Le mémoire descriptif est accessible dans la Base de données sur les brevets canadiens sur le site Web de l'Office de la propriété intellectuelle du Canada.*

*The Commissioner of Patents has granted a patent for the invention described in the specification under the above-noted patent number. The specification is accessible in the Canadian Patents Database on the website of the Canadian Intellectual Property Office.*

*Commissaire aux brevets  
Commissioner of Patents*

Titre de l'invention / Title of invention

MAT DE SOUFFLAGE ET SON PROCEDE DE FABRICATION

BLASTING MAT AND METHOD OF MANUFACTURING SAME

Breveté(s) / Patentee(s)

B2B INDUSTRIAL INC.

Inventeur(s) / Inventor(s)

FITZGERALD, KEVIN JAMES; BLAIS, DENIS

Date de l'octroi et de la délivrance du brevet /

Patent grant and issue date

2021-03-23

Date de dépôt de la demande /

Filing date of the application

2019-04-24

Date d'accessibilité au public /

Date application open to public inspection

2019-10-24

United  
States  
of  
America

To Promote the Progress



of Science and Useful Arts

### The Director

of the United States Patent and Trademark Office has received an application for a patent for a new and useful invention. The title and description of the invention are enclosed. The requirements of law have been complied with, and it has been determined that a patent on the invention shall be granted under the law.

Therefore, this United States

# Patent

grants to the person(s) having title to this patent the right to exclude others from making, using, offering for sale, or selling the invention throughout the United States of America or importing the invention into the United States of America, and if the invention is a process, of the right to exclude others from using, offering for sale or selling throughout the United States of America, products made by that process, for the term set forth in 35 U.S.C. 154(a)(2) or (c)(1), subject to the payment of maintenance fees as provided by 35 U.S.C. 41(b). See the Maintenance Fee Notice on the inside of the cover.

*Ander Lane*  
DIRECTOR OF THE UNITED STATES PATENT AND TRADEMARK OFFICE



US010739121B2

(12) **United States Patent**  
**Fitzgerald et al.**

(10) **Patent No.:** **US 10,739,121 B2**  
(45) **Date of Patent:** **Aug. 11, 2020**

- (54) **BLASTING MAT AND METHOD OF MANUFACTURING SAME**
- (71) Applicant: **B2B Industrial Inc., Copper Cliff (CA)**
- (72) Inventors: **Kevin James Fitzgerald, Copper Cliff (CA); Denis Blais, Sudbury (CA)**
- (73) Assignee: **B2B Industrial Inc., Cooper Cliff, Ontario (CA)**

2,926,605 A *	3/1960	Hammel, Jr. ....	F42D 5/05
			102/303
3,331,322 A *	7/1967	Belanger .....	F42D 5/05
			102/303
3,371,604 A *	3/1968	Lundgren .....	F42D 5/05
			102/303
3,567,568 A *	3/1971	Windecker .....	F41H 5/0478
			442/224
3,793,953 A *	2/1974	Lewis .....	F42D 5/05
			102/303

(Continued)

(\* ) Notice: Subject to any disclaimer, the term of this patent is extended or adjusted under 35 U.S.C. 154(b) by 0 days.

(21) Appl. No.: **16/393,013**

(22) Filed: **Apr. 24, 2019**

(65) **Prior Publication Data**

US 2019/0323812 A1 Oct. 24, 2019

**Related U.S. Application Data**

(60) Provisional application No. 62/661,851, filed on Apr. 24, 2018.

(51) **Int. Cl.**  
**F42D 5/05** (2006.01)

(52) **U.S. Cl.**  
CPC ..... **F42D 5/05** (2013.01)

(58) **Field of Classification Search**  
CPC ..... F42D 5/05; F41H 5/00; F41H 5/02; F41H 5/04; F41H 5/0478; F41H 5/06; E01C 9/08; E01C 9/086

See application file for complete search history.

(56) **References Cited**

**U.S. PATENT DOCUMENTS**

2,474,904 A	7/1949	Mazzella	
2,806,426 A *	9/1957	Klokseth .....	F42D 5/05
			102/303

**FOREIGN PATENT DOCUMENTS**

CN	208134169 U	3/2018	
FR	1482307 A *	5/1967	F42D 5/05

(Continued)

**OTHER PUBLICATIONS**

Blasting mats—BERGMA AS; information downloaded on Feb. 28, 2019 from <http://www.bergma.no/english/english/blasting-mats>.

(Continued)

*Primary Examiner* — Benjamin P Lee

(57) **ABSTRACT**

A blasting mat including a number of resilient elements arranged in a number of parallel rows that are located in a number of predetermined regions of the blasting mat. The resilient elements in each region are respectively subjected to a preselected compression pressure, to cause each region to have a respective preselected density within a range of preselected densities. The preselected density of at least a second selected one of the regions is greater than the preselected density of at least a first selected one of the regions.

**12 Claims, 12 Drawing Sheets**

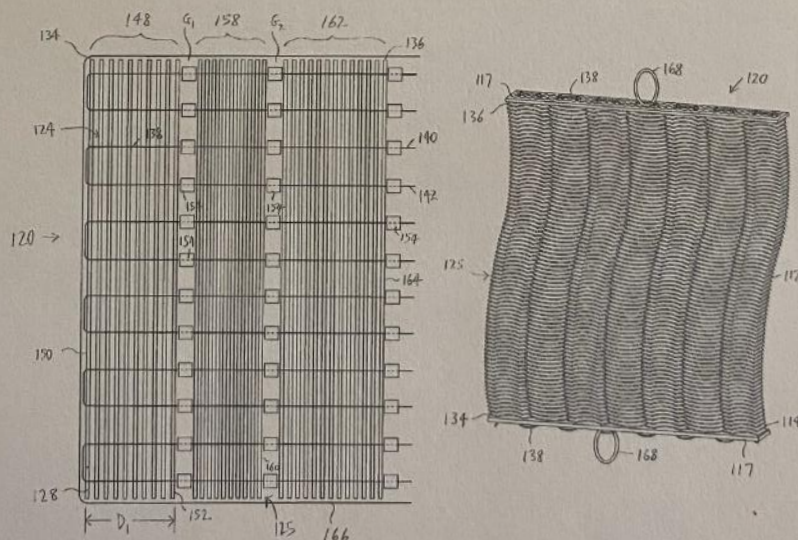

United States of America



To Promote the Progress

of Science and Useful Arts

### The Director

of the United States Patent and Trademark Office has received an application for a patent for a new and useful invention. The title and description of the invention are enclosed. The requirements of law have been complied with, and it has been determined that a patent on the invention shall be granted under the law.

Therefore, this United States

# Patent

grants to the person(s) having title to this patent the right to exclude others from making, using, offering for sale, or selling the invention throughout the United States of America or importing the invention into the United States of America, and if the invention is a process, of the right to exclude others from using, offering for sale or selling throughout the United States of America, products made by that process, for the term set forth in 35 U.S.C. 154(a)(2) or (c)(1), subject to the payment of maintenance fees as provided by 35 U.S.C. 41(b). See the Maintenance Fee Notice on the inside of the cover.

*Katherine Kelly Vidal*

DIRECTOR OF THE UNITED STATES PATENT AND TRADEMARK OFFICE



US011585647B2

(12) **United States Patent**  
**Fitzgerald**

(10) **Patent No.:** **US 11,585,647 B2**  
(45) **Date of Patent:** **Feb. 21, 2023**

(54) **LOW DENSITY BLASTING MAT AND METHOD OF UTILIZING SAME**

(71) Applicant: **B2B Industrial Inc.**, Sturgeon Falls (CA)

(72) Inventor: **Kevin James Fitzgerald**, Copper Cliff (CA)

(73) Assignee: **B2B Industrial Inc.**, Ontario (CA)

(\* ) Notice: Subject to any disclaimer, the term of this patent is extended or adjusted under 35 U.S.C. 154(b) by 0 days.

2,699,803 A	1/1955	Mazzella	
2,926,605 A	3/1960	Hammel, Jr. et al.	
3,371,604 A	3/1968	Per Folke Wikner et al.	
3,648,613 A *	3/1972	Cunn .....	F42D 5/05 102/303
3,793,953 A	2/1974	Lewis	
3,945,319 A	3/1976	Meagher	
4,326,668 A	4/1982	Granryd	
4,399,954 A *	8/1983	Arrant .....	E01C 13/08 242/615
4,407,606 A	10/1983	Larsen	
4,780,351 A *	10/1988	Czempoyesh .....	F42D 5/05 428/196
4,998,670 A	3/1991	Peterson	
5,364,206 A	11/1994	Mariefeld	

(Continued)

(21) Appl. No.: **17/407,327**

(22) Filed: **Aug. 20, 2021**

(65) **Prior Publication Data**  
US 2022/0057184 A1 Feb. 24, 2022

**Related U.S. Application Data**  
(60) Provisional application No. 63/067,914, filed on Aug. 20, 2020.

(51) **Int. Cl.**  
*F42D 5/05* (2006.01)  
*E02D 5/80* (2006.01)

(52) **U.S. Cl.**  
CPC ..... *F42D 5/05* (2013.01); *E02D 5/806* (2013.01)

(58) **Field of Classification Search**  
CPC ..... *F42D 5/05*  
USPC ..... 102/303; 86/50  
See application file for complete search history.

(56) **References Cited**  
U.S. PATENT DOCUMENTS

2,474,904 A	7/1949	Mazzella
2,474,905 A	7/1949	Mazzella

**FOREIGN PATENT DOCUMENTS**

JP	S62198400 U *	12/1987
RU	2314419 C1	1/2008
RU	2717323 C1	3/2020

**OTHER PUBLICATIONS**

Machine-Generated English Language Translation of RU2314419.  
Machine-Generated English Language Translation of RU2717323.

*Primary Examiner* — Bret Hayes

(57) **ABSTRACT**

A mat assembly including a planar mat body formed to cover a preselected area of a surface region. The preselected area partially defines a volume of ground to be broken by explosion therein. The mat body includes one or more layer elements. The mat body has an engagement surface for engagement with the preselected area. The mat assembly includes a skirt element connected with the mat body having an external portion extending from the mat body, for at least partially restraining matter ejected from the volume of ground upon initiation of the explosion.

**3 Claims, 13 Drawing Sheets**

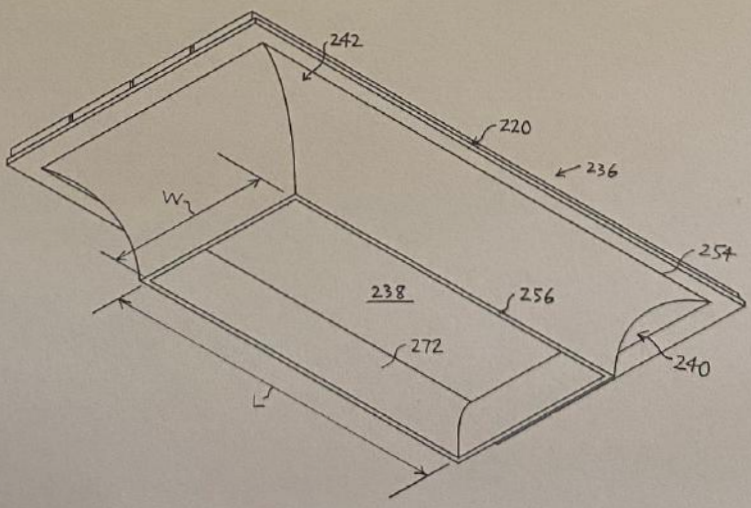





B2B Industrial, Inc.  
P.O. Box 658  
Copper Cliff, ON, Canada, P0M 1N0  
Telephone: (888) 823 5007

**Blasting Mats - Armadillo MAT, Rhino MAT, Elephant MAT, Manta Mat, Beluga, Gorilla Weight, Water Trough, Monkey FRK(KIT)**  
SDS Preparation Date (mm/dd/yyyy): 05/06/2021

### SAFETY DATA SHEET

#### SECTION 1. IDENTIFICATION

**Product identifier used on the label**

: **Blasting Mats - Armadillo MAT, Rhino MAT, Elephant MAT, Manta Mat, Beluga, Gorilla Weight, Water Trough, Monkey FRK(KIT)**

**Other means of identification** : No information available.

**Recommended use of the chemical and restrictions on use**

: To control flying debris from a blast using explosive products.  
Restriction on use: None known

**Chemical family**

: This product is considered to be a 'manufactured article'. This article is made up of recycled tires and wire.

**Name, address, and telephone number of the supplier:**

**B2B Industrial, Inc.**  
P.O. Box 658  
Copper Cliff, ON, Canada  
P0M 1N0

Supplier's Telephone # : 1-888-823-5007

**24 Hr. Emergency Tel #** : 1-888-823-5007(Monday - Friday, 8:00 am - 5:00 pm, Eastern Time)

**Name, address, and telephone number of the manufacturer:**

Refer to supplier

#### SECTION 2. HAZARDS IDENTIFICATION

**Classification of the chemical**

This product is considered to be a 'manufactured article'. This material is not classified as hazardous under U.S. OSHA regulations (29CFR 1910.1200) (Hazcom 2012) and Canadian WHMIS regulations (Hazardous Products Regulations) (WHMIS 2015).

**Label elements**

*Hazard pictogram(s)*

None required under U.S. OSHA Hazcom 2012 and Canadian WHMIS 2015 regulations.

*Signal Word*

Not required

*Hazard statement(s)*

Not required

*Precautionary statement(s)*

Not required

**Other hazards**

No other known hazards.



B2B Industrial, Inc.  
P.O. Box 658  
Copper Cliff, ON, Canada, P0M 1N0  
Telephone: (888) 823 5007

**Blasting Mats - Armadillo MAT, Rhino MAT,  
Elephant MAT, Manta Mat, Beluga, Gorilla  
Weight, Water Trough, Monkey FRK(KIT)**  
SDS Preparation Date (mm/dd/yyyy): 05/06/2021

Page 2 of 9

## SAFETY DATA SHEET

### SECTION 3. COMPOSITION/INFORMATION ON INGREDIENTS

This product is considered to be a 'manufactured article'. This article is made up of recycled tires and wire.

<u>Chemical name</u>	<u>Common name and synonyms</u>	<u>CAS #</u>	<u>Concentration (% by weight)</u>
No hazardous ingredients	Not available.	N/Av	N/Av

### SECTION 4. FIRST-AID MEASURES

#### Description of first aid measures

- Ingestion* : Not an expected route of entry. Never give anything by mouth to an unconscious person. Call a POISON CENTRE or doctor/physician if you feel unwell.
- Inhalation* : Not an expected route of entry. Move to fresh air. If breathing is difficult, give oxygen by qualified medical personnel only. If breathing has stopped, give artificial respiration. Obtain medical attention if symptoms develop and persist.
- Skin contact* : Wash with water and soap as a precaution. Remove and wash contaminated clothing before re-use. Obtain medical attention if symptoms develop and persist.
- Eye contact* : Flush eyes with water for at least 15 minutes. Obtain medical attention if symptoms develop and persist.

#### Most important symptoms and effects, both acute and delayed

- : Direct skin contact may cause slight or mild, transient irritation.

#### Indication of any immediate medical attention and special treatment needed

- : Treat symptomatically.

### SECTION 5. FIRE-FIGHTING MEASURES

#### Extinguishing media

- Suitable extinguishing media* : Use media suitable to the surrounding fire such as water fog or fine spray, alcohol foams, carbon dioxide and dry chemical.

- Unsuitable extinguishing media* : Do not use a solid water stream as it may scatter and spread fire.

#### Special hazards arising from the substance or mixture / Conditions of flammability

- : Burning may produce irritating, toxic and obnoxious fumes. Although tires do not ignite readily, if subjected to fire conditions they can burn rapidly emitting intense heat and large quantities of toxic smoke, becoming difficult to extinguish. A concentration of tires in any one area is a high hazard.

#### Flammability classification (OSHA 29 CFR 1910.106)

- : Not classified as flammable.

#### Hazardous combustion products

- : Carbon oxides

#### Special protective equipment and precautions for firefighters

##### Protective equipment for fire-fighters

- : Firefighters must use standard protective equipment including flame retardant coat, helmet with face shield, gloves, rubber boots, and in enclosed spaces, SCBA.

##### Special fire-fighting procedures

- : Firefighters should wear proper protective equipment and self-contained breathing apparatus with full face piece operated in positive pressure mode. Move containers from fire area if safe to do so. Water spray may be useful in cooling equipment exposed to heat and flame.



B2B Industrial, Inc.  
 P.O. Box 658  
 Copper Cliff, ON, Canada, P0M 1N0  
 Telephone: (888) 823 5007

**Blasting Mats - Armadillo MAT, Rhino MAT,  
 Elephant MAT, Manta Mat, Beluga, Gorilla  
 Weight, Water Trough, Monkey FRK(KIT)  
 SDS Preparation Date (mm/dd/yyyy): 05/06/2021**

**SAFETY DATA SHEET**

**SECTION 6. ACCIDENTAL RELEASE MEASURES**

**Personal precautions, protective equipment and emergency procedures**

- : Restrict access to area until completion of clean-up. Ensure clean-up is conducted by trained personnel only. Wear suitable protective equipment. Refer to protective measures listed in sections 7 and 8. Restrict access to area until completion of clean-up.

**Environmental precautions** : Ensure spilled product does not enter drains, sewers, waterways, or confined spaces.

**Methods and material for containment and cleaning up**

- : Ventilate area of release. Stop spill or leak at source if safely possible. Dike for water control. Use only non-sparking tools and equipment in the clean-up process. Contain and absorb spilled liquid with non-combustible, inert absorbent material (e.g. sand), then place absorbent material into a container for later disposal (see Section 13).

**Special spill response procedures**

- : If a spill/release in excess of the EPA reportable quantity is made into the environment, immediately notify the national response center in the United States (phone: 1-800-424-8802).  
 US CERCLA Reportable quantity (RQ): None.

In Canada: Contact appropriate local and provincial environmental authorities for assistance and/or reporting requirements.

**SECTION 7. HANDLING AND STORAGE**

**Precautions for safe handling**

- : Use only in well-ventilated areas. Wear suitable protective equipment during handling. Avoid contact with eyes, skin and clothing. Keep away from extreme heat and flame. Do not ingest. Keep away from incompatibles. Wash thoroughly after handling.

**Conditions for safe storage** : Although tires do not ignite readily, if subjected to fire conditions they can burn rapidly emitting intense heat and large quantities of toxic smoke, becoming difficult to extinguish. A concentration of tires in any one area is a high hazard. Store in a cool, dry, well-ventilated area. Store away from incompatible materials. Storage area should be clearly identified, clear of obstruction and accessible only to trained and authorized personnel. No smoking in the area.

**Incompatible materials** : Oxidizing agents

**SECTION 8. EXPOSURE CONTROLS / PERSONAL PROTECTION**

<u>Exposure Limits:</u>					
	<u>Chemical Name</u>	<u>ACGIH TLV</u>		<u>OSHA PEL</u>	
		<u>TWA</u>	<u>STEL</u>	<u>PEL</u>	<u>STEL</u>
No hazardous ingredients	N/Av	N/Av	N/Av	N/Av	

**Exposure controls**

**Ventilation and engineering measures**

- : Use in a well-ventilated area. Use general or local exhaust ventilation to maintain air concentrations below recommended exposure limits.



B2B Industrial, Inc.  
P.O. Box 658  
Copper Cliff, ON, Canada, P0M 1N0  
Telephone: (888) 823 5007

**Blasting Mats - Armadillo MAT, Rhino MAT,  
Elephant MAT, Manta Mat, Beluga, Gorilla  
Weight, Water Trough, Monkey FRK(KIT)  
SDS Preparation Date (mm/dd/yyyy): 05/06/2021**

Page 4 of 9

## SAFETY DATA SHEET

- Respiratory protection** : If airborne concentrations are above the permissible exposure limit or are not known, use NIOSH-approved respirators. Advice should be sought from respiratory protection specialists. Respirators should be selected based on the form and concentration of contaminants in air, and in accordance with OSHA (29 CFR 1910.134) or CSA Z94.4-02.
- Skin protection** : Gloves impervious to the material are recommended. Advice should be sought from glove suppliers.
- Eye / face protection** : Chemical goggles are recommended when there is a potential for splashing.
- Other protective equipment** : Wear sufficient clothing to prevent skin contact.
- General hygiene considerations** : Avoid contact with skin, eyes and clothing. Wash contaminated clothing before reuse. Upon completion of work, wash hands before eating, drinking, smoking or use of toilet facilities. Remove soiled clothing and wash it thoroughly before reuse. Handle in accordance with good industrial hygiene and safety practice.

### SECTION 9. PHYSICAL AND CHEMICAL PROPERTIES

- Appearance** : Recycled tires assembled with wire.
- Odour** : N/Av
- Odour threshold** : N/Av
- pH** : N/Av
- Melting Point/Freezing point** : N/Av
- Initial boiling point and boiling range** : N/Av
- Flash point** : N/Av
- Flashpoint (Method)** : N/Av
- Evaporation rate (BuAe = 1)** : N/Av
- Flammability (solid, gas)** : Not classified as flammable.
- Lower flammable limit (% by vol.)** : N/Av
- Upper flammable limit (% by vol.)** : N/Av
- Oxidizing properties** : None known.
- Explosive properties** : Not explosive
- Vapour pressure** : N/Av
- Vapour density** : N/Av
- Relative density / Specific gravity** : N/Av
- Solubility in water** : N/Av
- Other solubility(ies)** : N/Av
- Partition coefficient: n-octanol/water or Coefficient of water/oil distribution** : N/Av
- Auto-ignition temperature** : N/Av
- Decomposition temperature** : N/Av
- Viscosity** : N/Av
- Volatiles (% by weight)** : N/Av
- Volatile organic Compounds (VOC's)** : N/Av
- Absolute pressure of container** : N/Av



B2B Industrial, Inc.  
P.O. Box 658  
Copper Cliff, ON, Canada, P0M 1N0  
Telephone: (888) 823 5007

**Blasting Mats - Armadillo MAT, Rhino MAT,  
Elephant MAT, Manta Mat, Beluga, Gorilla  
Weight, Water Trough, Monkey FRK(KIT)**  
SDS Preparation Date (mm/dd/yyyy): 05/06/2021

Page 5 of 9

## SAFETY DATA SHEET

**Flame projection length** : N/Ap  
**Other physical/chemical comments**  
: No additional information.

### SECTION 10. STABILITY AND REACTIVITY

**Reactivity** : Not normally reactive.  
**Chemical stability** : Material is stable under normal conditions.  
**Possibility of hazardous reactions**  
: Hazardous polymerization does not occur.  
**Conditions to avoid** : Avoid excessive heat, sparks and open flame. Avoid contact with incompatible materials. Do not use in areas without adequate ventilation.  
**Incompatible materials** : Oxidizing agents  
**Hazardous decomposition products**  
: None known, refer to hazardous combustion products in Section 5.

### SECTION 11. TOXICOLOGICAL INFORMATION

#### Information on likely routes of exposure:

**Routes of entry inhalation** : NO  
**Routes of entry skin & eye** : YES  
**Routes of entry Ingestion** : YES  
**Routes of exposure skin absorption**  
: NO

#### Potential Health Effects:

##### Signs and symptoms of short-term (acute) exposure

###### *Sign and symptoms Inhalation*

: If product is heated or mists are formed, inhalation may cause irritation to the nose, throat and respiratory tract.

###### *Sign and symptoms ingestion*

: Ingestion may irritate digestive tract and cause nausea, vomiting and diarrhea.

###### *Sign and symptoms skin*

: Direct skin contact may result in little or no irritation.

###### *Sign and symptoms eyes*

: Direct eye contact may cause slight or mild, transient irritation.

##### Potential Chronic Health Effects

: Prolonged or repeated contact may cause drying, cracking and defatting of the skin.

##### Mutagenicity

: Not expected to be mutagenic in humans.

##### Carcinogenicity

: No components are listed as carcinogens by ACGIH, IARC, OSHA or NTP.

##### Reproductive effects & Teratogenicity

: Not expected to cause reproductive effects.

##### Sensitization to material

: Not expected to be a skin or respiratory sensitizer.

##### Specific target organ effects

: Not classified as a specific target organ toxicity-single exposure.

Not classified as specific target organ toxicity-repeated exposure.

##### Medical conditions aggravated by overexposure

: None known.

##### Synergistic materials

: Not available.



B2B Industrial, Inc.  
 P.O. Box 658  
 Copper Cliff, ON, Canada, P0M 1N0  
 Telephone: (888) 823 5007

**Blasting Mats - Armadillo MAT, Rhino MAT, Elephant MAT, Manta Mat, Beluga, Gorilla Weight, Water Trough, Monkey FRK(KIT)**  
 SDS Preparation Date (mm/dd/yyyy): 05/06/2021

**SAFETY DATA SHEET**

**Toxicological data** : There is no available data for the product itself, only for the ingredients. See below for individual ingredient acute toxicity data.

<u>Chemical name</u>	<u>LC<sub>50</sub>(4hr)</u> <u>inh, rat</u>	<u>LD<sub>50</sub></u>	
		<u>(Oral, rat)</u>	<u>(Rabbit, dermal)</u>
No hazardous ingredients	N/Av	N/Av	N/Av

**Other important toxicological hazards** : None known.

**SECTION 12. ECOLOGICAL INFORMATION**

**Ecotoxicity** : Contains material that may be harmful in the environment. Do not allow material to contaminate ground water system. See the following tables for individual ingredient ecotoxicity data.

**Ecotoxicity data:**

<u>Ingredients</u>	<u>CAS #</u>	<u>Toxicity to Fish</u>		
		<u>LC<sub>50</sub> / 96h</u>	<u>NOEC / 21 day</u>	<u>M Factor</u>
No hazardous ingredients	N/Av	N/Av	N/Av	N/Av

<u>Ingredients</u>	<u>CAS #</u>	<u>Toxicity to Daphnia</u>		
		<u>EC<sub>50</sub> / 48h</u>	<u>NOEC / 21 day</u>	<u>M Factor</u>
No hazardous ingredients	N/Av	N/Av	N/Av	N/Av

<u>Ingredients</u>	<u>CAS #</u>	<u>Toxicity to Algae</u>		
		<u>EC<sub>50</sub> / 96h or 72h</u>	<u>NOEC / 96h or 72h</u>	<u>M Factor</u>
No hazardous ingredients	N/Av	N/Av	N/Av	N/Av

**Persistence and degradability** : No information available.

**Bioaccumulation potential** : No information available.

<u>Components</u>	<u>Partition coefficient n-octanol/water (log Kow)</u>	<u>Bioconcentration factor (BCF)</u>
-------------------	--	--------------------------------------

**Mobility in soil** : No information available.

**Other Adverse Environmental effects** : No information available.

**SECTION 13. DISPOSAL CONSIDERATIONS**

**Handling for Disposal** : Handle waste according to recommendations in Section 7.



B2B Industrial, Inc.  
 P.O. Box 658  
 Copper Cliff, ON, Canada, P0M 1N0  
 Telephone: (888) 823 5007

**Blasting Mats - Armadillo MAT, Rhino MAT, Elephant MAT, Manta Mat, Beluga, Gorilla Weight, Water Trough, Monkey FRK(KIT)**  
 SDS Preparation Date (mm/dd/yyyy): 05/06/2021

**SAFETY DATA SHEET**

- Methods of Disposal** : Dispose in accordance with all applicable federal, state, provincial and local regulations.
- RCRA** : If this product, as supplied, becomes a waste in the United States, it may meet the criteria of a hazardous waste as defined under RCRA, Title 40 CFR 261. It is the responsibility of the waste generator to determine the proper waste identification and disposal method. For disposal of unused or waste material, check with local, state and federal environmental agencies.

**SECTION 14. TRANSPORT INFORMATION**

Regulatory Information	UN Number	UN proper shipping name	Transport hazard class(es)	Packing Group	Label
49CFR/DOT	None.	Not regulated.	not regulated	none	
49CFR/DOT Additional information	None.				
TDG	None.	Not regulated.	Not regulated	none	
TDG Additional information	None.				

- Special precautions for user** : None known or reported by the manufacturer.
- Environmental hazards** : This substance does not meet the criteria for an environmentally hazardous substance according to the IMDG Code. See ECOLOGICAL INFORMATION, Section 12.
- Transport in bulk according to Annex II of MARPOL 73/78 and the IBC Code**  
 : Not available.

**SECTION 15 - REGULATORY INFORMATION**

**US Federal Information:**

Components listed below are present on the following U.S. Federal chemical lists:

<u>Ingredients</u>	CAS #	TSCA Inventory	CERCLA Reportable Quantity(RQ) (40 CFR 117.302):	SARA TITLE III: Sec. 302, Extremely Hazardous Substance, 40 CFR 355:	SARA TITLE III: Sec. 313, 40 CFR 372, Specific Toxic Chemical	
					Toxic Chemical	de minimus Concentration
No hazardous ingredients	N/Av	N/Av	N/Av	N/Av	No	N/Av

SARA TITLE III: Sec. 311 and 312, SDS Requirements, 40 CFR 370 Hazard Classes: None.  
 Under SARA Sections 311 and 312, the EPA has established threshold quantities for the reporting of hazardous chemicals. The current thresholds are 500 pounds or the threshold planning quantity (TPQ), whichever is lower, for extremely hazardous substances and 10,000 pounds for all other hazardous chemicals.



B2B Industrial, Inc.  
P.O. Box 658  
Copper Cliff, ON, Canada, P0M 1N0  
Telephone: (888) 823 5007

**Blasting Mats - Armadillo MAT, Rhino MAT,  
Elephant MAT, Manta Mat, Beluga, Gorilla  
Weight, Water Trough, Monkey FRK(KIT)  
SDS Preparation Date (mm/dd/yyyy): 05/06/2021**

Page 8 of 9

## SAFETY DATA SHEET

### US State Right to Know Laws:

The following chemicals are specifically listed by individual States:

<u>Ingredients</u>	CAS #	California Proposition 65		State "Right to Know" Lists					
		Listed	Type of Toxicity	CA	MA	MN	NJ	PA	RI
No hazardous ingredients	N/Av	No	N/Ap	No	No	No	No	No	No

### Canadian Information:

WHMIS information: Refer to Section 2 for a WHMIS Classification for this product.

Canadian Environmental Protection Act (CEPA) information: All ingredients listed appear on the Domestic Substances List (DSL).

### International Information:

Components listed below are present on the following International Inventory list:

<u>Ingredients</u>	CAS #	European EINECS	Australia AICS	Philippines PICCS	Japan ENCS	Korea KECI/KECL	China IECSC	NewZealand IOC
No hazardous ingredients	N/Av	N/Av	N/Av	N/Av	N/Av	N/Av	N/Av	N/Av

### SECTION 16. OTHER INFORMATION

#### Legend

: ACGIH: American Conference of Governmental Industrial Hygienists  
 CAS: Chemical Abstract Services  
 CERCLA: Comprehensive Environmental Response, Compensation, and Liability Act of 1980  
 CFR: Code of Federal Regulations  
 CSA: Canadian Standards Association  
 DOT: Department of Transportation  
 EPA: Environmental Protection Agency  
 HMIS: Hazardous Materials Identification System  
 HSDB: Hazardous Substances Data Bank  
 IARC: International Agency for Research on Cancer  
 Inh: Inhalation  
 LC: Lethal Concentration  
 LD: Lethal Dose  
 MN: Minnesota  
 N/Ap: Not Applicable  
 N/Av: Not Available  
 NFPA: National Fire Protection Association  
 NIOSH: National Institute of Occupational Safety and Health  
 NJ: New Jersey  
 NTP: National Toxicology Program  
 OECD: Organisation for Economic Co-operation and Development  
 OSHA: Occupational Safety and Health Administration  
 PA: Pennsylvania  
 PEL: Permissible exposure limit  
 RCRA: Resource Conservation and Recovery Act  
 RI: Rhode Island





B2B Industrial, Inc.  
P.O. Box 658  
Copper Cliff, ON, Canada, P0M 1N0  
Telephone: (888) 823 5007

**Blasting Mats - Armadillo MAT, Rhino MAT,  
Elephant MAT, Manta Mat, Beluga, Gorilla  
Weight, Water Trough, Monkey FRK(KIT)  
SDS Preparation Date (mm/dd/yyyy): 05/06/2021**

**SAFETY DATA SHEET**

RTECS: Registry of Toxic Effects of Chemical Substances  
SARA: Superfund Amendments and Reauthorization Act  
STEL: Short Term Exposure Limit  
TLV: Threshold Limit Values  
TWA: Time Weighted Average  
WHMIS: Workplace Hazardous Materials Identification System

- References** :
1. ACGIH, Threshold Limit Values for Chemical Substances and Physical Agents & Biological Exposure Indices
  2. ECHA - European Chemical Agency
  3. Canadian Centre for Occupational Health and Safety, CCInfoWeb databases, (Chempendium, HSDB and RTECs).
  4. Safety Data Sheets from manufacturer.
  5. US EPA Title III List of Lists
  6. California Proposition 65 List
  7. OECD - The Global Portal to Information on Chemical Substances - eChemPortal

**Preparation Date (mm/dd/yyyy)**  
: 05/06/2021

**Other special considerations for handling**  
: Provide adequate information, instruction and training for operators.

<p><b>Prepared for:</b> B2B Industrial, Inc. P.O. Box 658 Copper Cliff, Ontario P0M 1N0 Telephone: 1-888-823-5007</p>	

**DISCLAIMER**

B2B Industrial, Inc. expressly disclaim all expressed or implied warranties and assume no responsibilities for the accuracy or completeness of the data contained herein. The data in this SDS does not apply to use with any other product or in any other process.

This Safety Data Sheet may not be changed, or altered in any way without the expressed knowledge and permission of B2B Industrial, Inc.

**END OF DOCUMENT**



GET STARTED TODAY BY VISITING  
[WWW.B2BII.COM](http://WWW.B2BII.COM) FOR A VALUE PROPOSITION.  
CALL OUR CANADIAN AND USA NUMBERS AT  
CA | 1 (877) 456-6768 • US | 1 (888) 823-5007

**B2B**  
Industrial, Inc.