

**¿UNA MALA
ILUMINACIÓN
TE HACE SENTIR
INSEGURO?**

CÁMBIATE A LEDVANCE



LEDVANCE



**LUMINARIAS, COMPONENTES
ELECTRÓNICOS, LÁMPARAS LED**

2024

ARQUITECTURA DE MARCA

EMPRESA:  **LEDVANCE**

MARCAS:  **LEDVANCE**

OSRAM 



Luminarias LED
y productos innovadores



Lámparas LED

CONOZCA LEDVANCE

Somos uno de los principales proveedores de iluminación del mundo para profesionales y consumidores finales.

LEDVANCE ha surgido del negocio de iluminación de OSRAM y ofrece una amplia gama de luminarias LED para diversas áreas de aplicación, uno de los mayores portafolios de lámparas LED del sector, además de productos para la iluminación tradicional.

SOMOS LEDVANCE

Nuestro nombre combina el origen de la compañía con la visión de redefinir el rol de la luz en el mundo.

LED hace referencia a la iluminación como nuestro negocio principal y expresa la creciente importancia de los productos LED en nuestra compañía.

ADVANCE representa la ambición de nuestra compañía de ser una fuerza impulsora en la industria de la iluminación, pero también más allá.

El logotipo LEDVANCE es representado por un pulso de luz, que ilustra el avance y dinamismo de la empresa, traemos la luz a la vida de las personas.

LÁMPARAS OSRAM

Derivado a un acuerdo con OSRAM, LEDVANCE seguirá comercializando la marca OSRAM para la línea de lámparas tradicionales y LED.

Más información se puede encontrar en el sitio:
www.ledvance.lat

LEDVANCE: AVANZANDO CON LA LUZ

¿BUSCAS ILUMINACIÓN DE CALIDAD? CÁMBIATE A LEDVANCE.

Como un socio confiable para productos de iluminación general, luchamos contra productos de mala calidad en todo lo que hacemos. En LEDVANCE, combinamos la iluminación tradicional en general con tecnologías innovadoras, construimos relaciones duraderas con los clientes y una fuerte red de distribución de nuestros productos.

En todo el mundo somos especialistas en iluminación, en nuevas tecnologías y cambiamos para satisfacer las necesidades del mercado. Estamos presentes en más de 140 países, atendiendo demandas específicas y ayudando a clientes con nuestro equipo de expertos. Nuestra cartera de luminarias cubre todas las aplicaciones profesionales y residenciales.

Para concientizar a los consumidores sobre los productos de baja calidad disponibles en el mercado y posicionar a LEDVANCE como una marca nueva y fuerte, estamos lanzando la campaña "UNA MALA ILUMINACIÓN ARRUINA TU DÍA".

La campaña hace alusión a los problemas que los productos de mala calidad ocasionan en proyectos de iluminación, y sugiere la marca LEDVANCE, que siempre ofrecerá un producto de calidad, de fácil instalación y de excelente costo-beneficio. Para atraer la atención del público, se vale de imágenes fuertes, de excelente calidad escenográfica, con leve toque de humor.



EXPERIMENTA UNA NUEVA LUZ

PRESENTE EN MÁS DE 140 PAÍSES.

Europa, Estados Unidos y Canadá,
Asia y Región Pacífica,
América Latina, África y Medio Oriente.

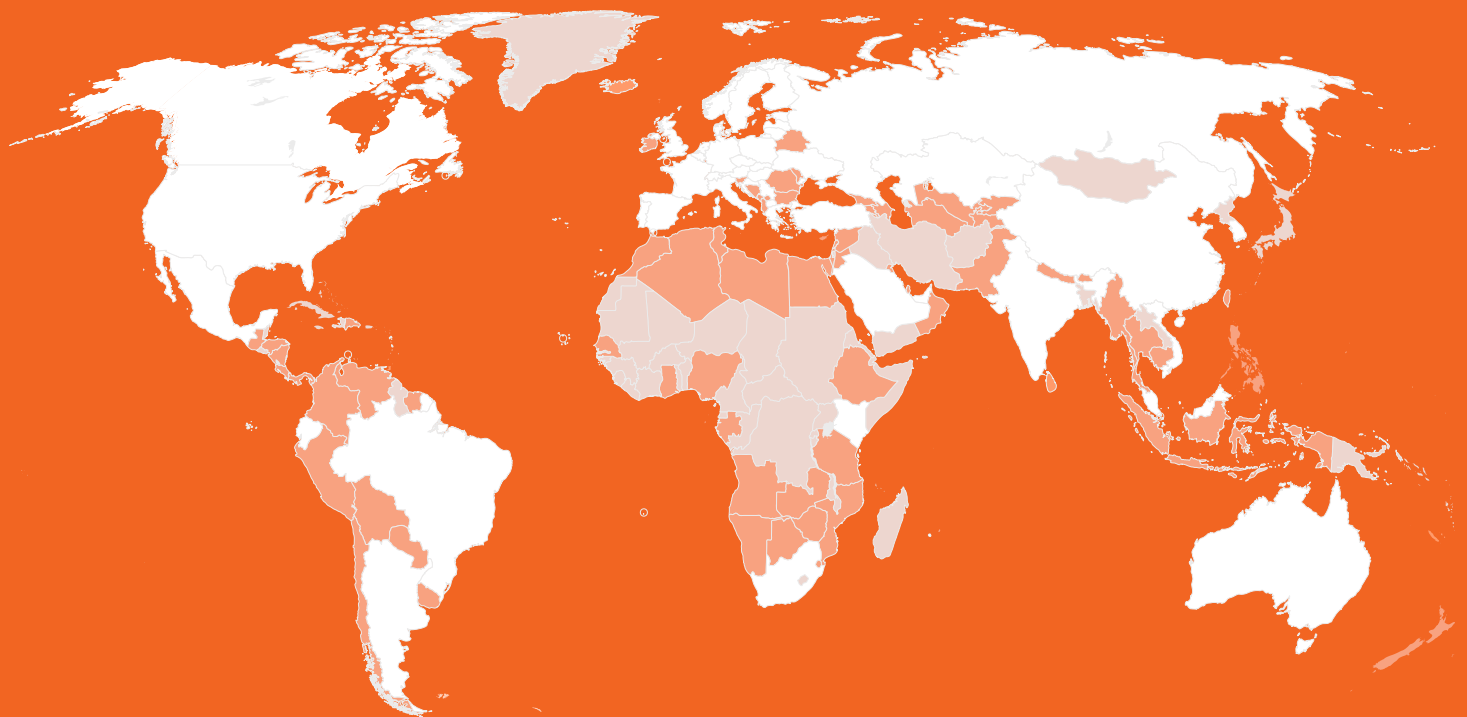

ILUMINACIÓN DE UN COMERCIO ALTOS ESTÁNDARES, DIFERENTES

SABIENDO LO QUE IMPORTA...

Los desafíos para planificar la iluminación en espacios comerciales son extremadamente diversos, complejos y diferentes en cada tienda. Detrás de la exitosa iluminación de un comercio hay conocimientos técnicos y experiencia basada en aplicaciones LEDVANCE lo apoya con asesoramiento a medida y soluciones de iluminación modernas.

1. VENTA EFECTIVA



- Presentación atractiva de productos y marca.
- Adaptación óptima del concepto de iluminación a la mercancía y la situación de la tienda, a través de combinaciones personalizadas de iluminación general, de enfoque y efectos.

2. ENCUENTRE SU RECORRIDO



- Diseño de iluminación variada que diferencie el espacio y guíe a los clientes.
- Iluminación de seguridad para casos de emergencia.

4. ALTO CONFORT VISUAL



CIO MODERNO: S DESAFÍOS

3. ESCAPARATES



- La excelente reproducción de color (IRC > 90) y la temperatura de color adecuada otorgan un mejor efecto destacando materiales y colores.
- La iluminación de enfoque a través del spot proporciona efectos extraordinarios.

- Crear transparencia a través de altos niveles de iluminación.
- Exhibición con importantes contrastes acentuados con la iluminación.
- Evite el deslumbramiento para clientes y empleados: tomando en cuenta propiedades anti deslumbramiento y posicionamiento correcto de las luminarias.
- Iluminación vertical uniforme para áreas de estantería.

5. PRESENTACIÓN ATRACTIVA



6. GRANDES AHORROS ENERGÉTICOS

- La tecnología LED moderna, duradera y con un manejo de luz inteligente (por ejemplo, a través de sensores de luz y presencia) proporciona alta eficacia energética, bajo mantenimiento y bajos costos de operación.



ÍNDICE

LUMINARIAS LEDVANCE

RESIDENCIAL

PANAN DISC SINGLE	11
DESKLUM	12
SLIM PLAFON	13
INSERT SQUARE	14
INSERT ROUND	15
LIVIN	16

PROFESIONAL / COMERCIAL

PANEL PERFORMANCE	19
PANEL PFM DIM	20
PANEL PFM TROFFER	21
SPOTLIGHT	22
SPOTLIGHT MODULAR	23
SPOTLIGHT VARIO	25
DOWNLIGHT	26
DOWNLIGHT PARA BOTE INTEGRAL	27
DOWNLIGHT RT	28
LINEAR	29
LINEAR BATTEN T5	30
LINEAR PENDANT	31
MULTI LINEAR	32
MULTI ROUND	33
LOWBAY	34
PENDULUM	35
PENDULUM INDUSTRIAL & RETRO	36
STRING LIGHT	37
TRACKLIGHT	38
TRACKLIGHT ZOOM	41
TRACKLIGHT SPOT ZOOM	42
EMERGENCY LIGHT 2X1W	43

INDUSTRIAL

HIGHBAY 220 V	46
HIGHBAY PERFORMANCE	47
HIGHBAY NSF	48
HIGHBAY PREMIER	49
CANOPY	50
PLANT GROWTH	51
FLOODLIGHT MIDDLE WATTAGE PERFORMANCE	52
FLOODLIGHT HIGH POWER	53
FLOODLIGHT HIGH POWER 1KW	54
FLOODLIGHT HIGH POWER 1KW DMX	55
FLOODLIGHT 1.4 KW	56
DAMP PROOF HOUSING	57
DAMP PROOF SLIM	58
DAMP PROOF LED PERFORMANCE	59
DAMP PROOF LED PFM SENSOR	60
DAMP PROOF EMERGENCY DRIVER	61
VAPOR TIGHT PFM	62
WALL PACK	63

EXTERIOR

SPIKE	66
UPLIGHT	67
WALL LIGHT APLIQUE SINGLE & DUAL HOUSING	68
WALL LIGHT DECOLED	69
ENDURA	70
SOLAR WALL	71
SOLAR FLOODLIGHT Y SECURITY LIGHT	72
FLOODLIGHT LOW WATTAGE PERFORMANCE	73
FLOODLIGHT SENSOR PERFORMANCE	74
FLOODLIGHT RGBW	75
URBANA	76
BULKHEAD	77

ALUMBRADO PÚBLICO

AREALIGHT PHOTOCELL	80
STREETLIGHT 10Y	81
SOLAR STREETLIGHT	82



RESIDENCIAL





LEDVANCE® PANAN DISC SINGLE

Luminaria de escritorio que favorecerá al máximo tu rendimiento, concentración y bienestar regulando la intensidad de la luz con su interruptor táctil. Cuenta con una batería recargable que garantiza cuatro horas de libertad inalámbrica, además ofrece conexión directa al puerto USB de la computadora o laptop. Es el compañero ideal en la oficina en casa o rincón de lectura.

Desk lamp that will maximize your performance, concentration and well-being by regulating the intensity of the light with its touch switch. It has a rechargeable battery that guarantees four hours of wireless freedom, also offers direct connection to the USB port of the computer or laptop. It is the ideal companion in the home office or reading corner.



- 2**
AÑOS DE GARANTÍA
- 5V**
- 10% 100%
ATENUABLE
- TIEMPO DE CARGA BATERÍA 6h**
- TOUCH
- 2**
COLORES

APLICACIONES / APPLICATIONS



Código Sku	Potencia Power (W)	Flujo Luminoso Luminous Flux (lm)	Ángulo de Apertura Opening Angle	Temp. de Color Color Temp. (K)	IRC CRI	Vida Útil Life (h)	Dimensiones Dimensions (mm)	Color de Producto Product Color	Unidades por Caja Units per box
88393	5	220	105°	3000	> 80	30 000	170 x 350 x 370	Blanco	4
88394	5	220	105°	3000	> 80	30 000	170 x 350 x 370	Gris	4



LEDVANCE® DESKLUM

Luminaria de escritorio que se integra perfectamente en cualquier espacio, un complemento ideal para realizar actividades de manera más eficiente, productiva y cómoda. Su diseño ergonómico permite obtener luz precisa para un tipo de actividad en específico, ajustando el brillo o la temperatura de color de acuerdo a las necesidades mediante su botón táctil.

Desk lamp that integrates perfectly into any space, an ideal complement to carry out activities in a more efficient, productive and comfortable way. Its ergonomic design allows to obtain precise light for a specific type of activity, adjusting the brightness or color temperature according to the needs through its touch button.



APLICACIONES / APPLICATIONS



Código Sku	Potencia Power (W)	Flujo Luminoso Luminous Flux (lm)	Ángulo de Apertura Opening Angle	Temp. de Color Color Temp. (K)	IRC CRI	Vida Útil Life (h)	Dimensiones Dimensions (mm)	Color de Producto Product Color	Unidades por Caja Units per box
88444	3	220	90°	2 700 - 6 500	> 80	10 000	286 x 336 x 170	Negro	16
88445	3	220	90°	2 700 - 6 500	> 80	10 000	286 x 336 x 170	Blanco	16



LEDVANCE® SLIM PLAFON

Luminaria de techo para sobreponer o empotrar tipo plafón, con diseño compacto y marco reducido que emite una luz homogénea a través de su difusor. Disponible en versiones redondo y cuadrado en dos temperaturas de color: Luz de Día (6500 K) y Luz Cálida (3000 K). De fácil y rápida instalación.

It is a ceiling luminaire to embed, recessed lighting fixture type. It has an ultrafine design and reduced frame, which emits homogeneous light through its diffuser. Available in round and square versions, at two color temperatures: Day Light (6500 K) and Warm Light (3000 K). Quick and easy to install.



HASTA
50%
DE AHORRO
DE ENERGÍA

3
AÑOS DE
GARANTÍA

100 – 240 V~

IP20

DISEÑO
COMPACTO
MARCO
REDUCIDO

DISTRIBUCIÓN
DE LUZ
UNIFORME

2 X 1
APLICACIÓN
DUAL

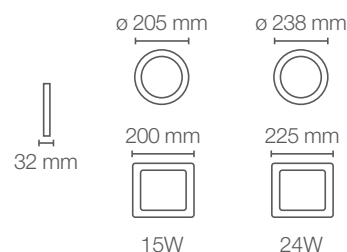

APLICACIONES / APPLICATIONS



Código Sku	Potencia Power (W)	Equivalencia Equivalence CFLI (W)	Flujo Luminoso Luminous Flux (lm)	Ángulo de Apertura Opening Angle	Temp. de Color Color Temp. (K)	Vida Útil Life (h)	IRC CRI	Dimensiones Dimensions (mm)	Color de Producto Product Color	Unidades por Caja Units per box
86490	15	2 x 15	1 125	120°	3000	25 000	> 80	∅ 205 x 32	Blanco	10
86491	15	2 x 15	1 125	120°	3000	25 000	> 80	200 x 200 x 32	Blanco	10
86492	15	2 x 15	1 125	120°	6500	25 000	> 80	∅ 205 x 32	Blanco	10
86493	15	2 x 15	1 125	120°	6500	25 000	> 80	200 x 200x32	Blanco	10
86495	24	2 x 23	1 800	120°	3000	25 000	> 80	225 x 225 x 32	Blanco	10
86496	24	2 x 23	1 800	120°	6500	25 000	> 80	∅ 238 x 32	Blanco	10
86497	24	2 x 23	1 800	120°	6500	25 000	> 80	225 x 225 x 32	Blanco	10

* En sustitución de lámparas CFLI compactas / In the replacement of compact CFLI lamps.



LEDVANCE® INSERT SQUARE

Luminaria de techo para empotrar con diseño ultra delgado y con una distribución de luz homogénea. Equipada con LED de alta potencia. Disponible en versión cuadrado con tres temperaturas de color: Blanco Frío (4000 K) y Luz de Día (6500 K). Instalación fácil y rápida.

Indoor lighting with ultra slim design and homogeneous distribution light. Equipped with high power led. Available in three versions: Warm Light (3000 K), Cool Light (4000 K) and Day Light (6500 K). Easy and fast installing.

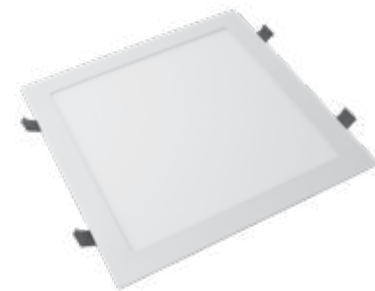

HASTA
50%
DE AHORRO
DE ENERGÍA

3
AÑOS DE
GARANTÍA

100 – 240 V~

IP20

DISTRIBUCIÓN
DE LUZ
UNIFORME

DISEÑO
ULTRA DELGADO

23 mm

172 mm
12W

225 mm
18W

300 mm
24W

APLICACIONES / APPLICATIONS



Código SKU	Potencia Power (W)	Equivalencia Equivalence CFLI (W)	Flujo Luminoso Luminous Flux (lm)	Ángulo de Apertura Opening Angle	Temp. de Color Color Temp. (K)	Vida Útil Life (h)	IRC CRI	Dimensiones Dimensions (mm)	Color de Producto Product Color	Unidades por Caja Units per box
86443	12	2 x 13	950	120°	○ 4000	25 000	>80	172 x 172 x 23	Blanco	10
86444	12	2 x 13	950	120°	● 6500	25 000	>80	172 x 172 x 23	Blanco	10
86450	18	2 x 15	1 500	120°	● 6500	25 000	>80	225 x 225 x 23	Blanco	10
86456	24	2 x 23	2 200	120°	● 6500	25 000	>80	300 x 300 x 23	Blanco	10

* En sustitución de lámparas CFLI compactas / In the replacement of compact CFLI lamps.



LEDVANCE® INSERT ROUND

Luminaria de techo para empotrar con diseño ultra delgado y con una distribución de luz homogénea. Equipada con LED de alta potencia. Disponible en versión redondo con tres temperaturas de color: Luz Cálida (3000 K), Blanco Frío (4000 K) y Luz de Día (6500 K). Instalación fácil y rápida.

Indoor lighting with ultra slim design and homogeneous distribution light. Equipped with high power led. Available in three versions: Warm Light (3000 K), Cool Light (4000 K) and Day Light (6500 K). Easy and fast installing.

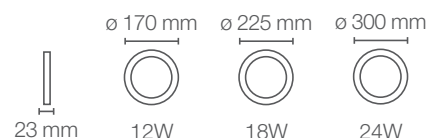

APLICACIONES / APPLICATIONS



Código Sku	Potencia Power (W)	Equivalencia Equivalence CFLI (W)	Flujo Luminoso Luminous Flux (lm)	Ángulo de Apertura Opening Angle	Temp. de Color Color Temp. (K)	Vida Útil Life (h)	IRC CRI	Dimensiones Dimensions (mm)	Color de Producto Product Color	Unidades por Caja Units per box
86445	12	2 x 13	950	120°	● 3000	25 000	>80	Ø 170 x 23	Blanco	10
86446	12	2 x 13	950	120°	○ 4000	25 000	>80	Ø 170 x 23	Blanco	10
86447	12	2 x 13	950	120°	● 6500	25 000	>80	Ø 170 x 23	Blanco	10
86451	18	2 x 15	1 500	120°	● 3000	25 000	>80	Ø 225 x 23	Blanco	10
86452	18	2 x 15	1 500	120°	○ 4000	25 000	>80	Ø 225 x 23	Blanco	10
86453	18	2 x 15	1 500	120°	● 6500	25 000	>80	Ø 225 x 23	Blanco	10
86458	24	2 x 23	2 200	120°	○ 4000	25 000	>80	Ø 300 x 23	Blanco	10
86459	24	2 x 23	2 200	120°	● 6500	25 000	>80	Ø 300 x 23	Blanco	10

* En sustitución de lámparas CFLI compactas / In the replacement of compact CFLI lamps.



LEDVANCE® LIVIN

Luminaria de techo para sobreponer con diseño lineal y moderno. Está equipada con LED de alta potencia con luz blanca, que ilumina el ambiente de manera uniforme. Instalación fácil y rápida. Disponible en versiones corta y larga.

Indoor lighting with a linear and modern design. Equipped with high power led with day lighth, it lights up uniformly the environment. Easy and fast installing.

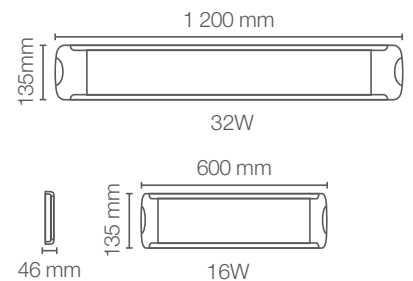

APLICACIONES / APPLICATIONS

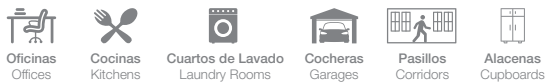

Código Sku	Potencia Power (W)	Equivalencia Equivalence Fluor. (W)	Flujo Luminoso Luminous Flux (lm)	Ángulo de Apertura Opening Angle	Temp. de Color Color Temp. (K)	IRC CRI	Vida Útil Life (h)	Dimensiones Dimensions (mm)	Color de Producto Product Color	Unidades por Caja Units per box
83194	16	2 x 17 T8	1 400	110°	5000	>80	30 000	600 x 135 x 46	Blanco	10
83195	32	2 x 32 T8	3 000	110°	5000	>80	30 000	1200 x 135 x 46	Blanco	8

* En sustitución de lámparas fluorescentes tubulares / In the replacement of tubular fluorescent lamps.



PROFESIONAL / COMERCIAL



LEDVANCE® PANEL PERFORMANCE

LEDVANCE PANEL implementa tecnología Backlit lo que permite una mejor distribución de luz sin percibir los puntos de luz en el difusor, disponible en 3 versiones: 60x60 cm (36W) y 60x120 cm (54W).

LEDVANCE PANEL implements Backlit technology which allows a better distribution of light without perceiving the points of light in the diffuser, available in 3 versions: 60x60 cm (36W) and 60x120 cm (54W).



HASTA
30%
DE AHORRO
DE ENERGÍA

5
AÑOS DE
GARANTÍA

100-277~V

IP20

SIN CORTES
DIAGONALES

DRIVER
EXTERNO

DISTRIBUCIÓN
DE LUZ
UNIFORME

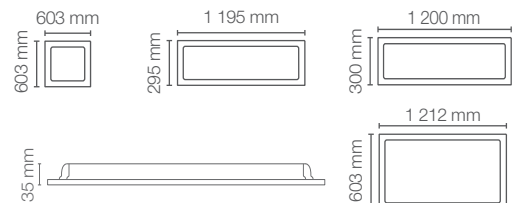

APLICACIONES / APPLICATIONS



Código Sku	Potencia Power (W)	Equivalencia Equivalence Fluor. (W)	Flujo Luminoso Luminous Flux (lm)	Ángulo de Apertura Opening Angle	Temp. de Color Color Temp. (K)	Vida Útil Life (h)	IRC CRI	Dimensiones Dimensions (mm)	Color de Producto Product Color	Unidades por Caja Units per box
89373	36	3 x 14W T5 o 2 x 32W T8	4 320	114°	● 3000	50 000	>80	□ 603 x 603 x 35	Blanco	5
89374	36	3 x 14W T5 o 2 x 32W T8	4 320	114°	○ 4000	50 000	>80	□ 603 x 603 x 35	Blanco	5
89375	36	3 x 14W T5 o 2 x 32W T8	4 320	114°	● 5000	50 000	>80	□ 603 x 603 x 35	Blanco	5
89376	36	3 x 14W T5 o 2 x 32W T8	4 320	114°	● 6500	50 000	>80	□ 603 x 603 x 35	Blanco	5
89377	36	2 x 28W T5 o 2 x 32W T8	4 320	114°	● 3000	50 000	>80	▭ 300 x 1200 x 35	Blanco	5
89378	36	2 x 28W T5 o 2 x 32W T8	4 320	114°	○ 4000	50 000	>80	▭ 300 x 1200 x 35	Blanco	5
89379	36	2 x 28W T5 o 2 x 32W T8	4 320	114°	● 6500	50 000	>80	▭ 300 x 1200 x 35	Blanco	5
89381	54	3 x 28W T5 o 3 x 32W T8	6 480	114°	○ 4000	50 000	>80	▭ 603 x 1212 x 35	Blanco	5
89382	54	3 x 28W T5 o 3 x 32W T8	6 480	114°	● 6500	50 000	>80	▭ 603 x 1212 x 35	Blanco	5



Accesorios*
Accessories*

86913	Marco para sobreponer Panel 600 x 600
86914	Marco para sobreponer Panel 300 x 1200
86915	Marco para sobreponer Panel 600 x 1200
86916	Kit de Suspensión
86917	Clips de Montaje

* Se venden por separado / They are sold separately.

* En sustitución de lámparas fluorescentes tubulares / In replacement of tubular fluorescent lamps.



LEDVANCE® PANEL PFM DIM

Gracias al protocolo de atenuación 0-10 V, ahora podrás tener el control total de tu iluminación. Podrás implementar dimmers tradicionales o incluso ir al siguiente nivel implementando sistemas de control inalámbricos, por medio del canal de comunicación 0-10 V y así eficientizar aún más tu instalación. No pierdas la oportunidad de actualizar tus espacios y tomar el control de tu iluminación de una manera excepcional.

Thanks to the 0-10 V dimming protocol, you can now have full control of your lighting. You can implement traditional dimmers or even go to the next level by implementing wireless control systems, through the 0-10 V communication channel and thus make your installation even more efficient. Don't miss the opportunity to update your spaces and take control of your lighting in an exceptional way.

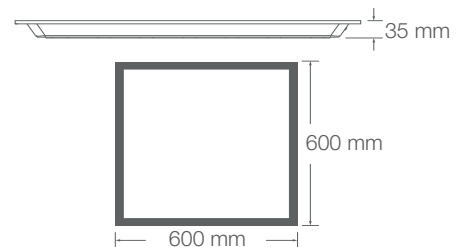

APLICACIONES / APPLICATIONS



Código Sku	Potencia Power (W)	Equivalencia Equivalence Fluor. (W)	Flujo Luminoso Luminous Flux (lm)	Ángulo de Apertura Opening Angle	Temp. de Color Color Temp. (K)	IRC CRI	Vida Útil Life (h)	Dimensiones Dimensions (mm)	Color de Producto Product Color	Unidades por Caja Units per box
89984	36	3 x 14W o 2 x 32W T8	4 320	114°	○ 4000	>80	50 000	603 x 603 x 35	Blanco	5
89986	36	3 x 14W o 2 x 32W T8	4 320	114°	● 6500	>80	50 000	603 x 603 x 35	Blanco	5



Accesorios* Accessories*

86913	Marco para sobreponer Panel 600 x 600
86914	Marco para sobreponer Panel 300 x 1200
86915	Marco para sobreponer Panel 600 x 1200
86916	Kit de Suspensión
86917	Clips de Montaje

* Se venden por separado / They are sold separately.

* En sustitución de lámparas fluorescentes tubulares / In replacement of tubular fluorescent lamps.



LEDVANCE® PANEL PFM TROFFER

PANEL TROFFER combina la estética clásica de los gabinetes tradicionales con la eficiencia y la durabilidad de la tecnología LED. Su aspecto clásico garantiza una fácil instalación y reemplazo de los sistemas existentes, mientras que su rendimiento y vida útil prolongada superan con creces a los tubos fluorescentes convencionales.

PANEL TROFFER combines the classic aesthetics of traditional cabinets with the efficiency and durability of LED technology. Its classic appearance ensures easy installation and replacement of existing systems, while its performance and long life far exceed conventional fluorescent tubes.



19 W
24 W
32 W
39 W

PANEL
600 X 600

29 W
34 W
39 W
49 W

PANEL
600 X 1 200

TEMPERATURA
3 EN 1

HASTA
100 000h
VIDA ÚTIL
L70

IP 20

0 10
ATENUABLE

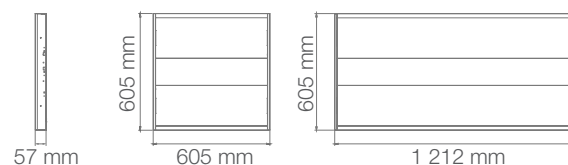

APLICACIONES / APPLICATIONS



Código Sku	Potencia Seleccionable Selectable Power (W)	Flujo Luminoso Luminous Flux (lm)	Ángulo de Apertura Opening Angle	Temp. de Color Color Temp. (K)	IRC CRI	Vida Útil Life (h)	Dimensiones Dimensions (mm)	Color de Producto Product Color	Unidades por Caja Units per box
90007	19W / 24W / 32W / 39W	2 660 lm / 3 360 lm / 4 480 lm / 5 460 lm	110°	● 3500 ○ 4000 ● 5000	>80	50 000	605 x 605 x 57	Blanco	1
90008	29W / 34W / 39W / 49W	4 350 lm / 5 100 lm / 5 850 lm / 7 350 lm	110°	● 3500 ○ 4000 ● 5000	>80	50 000	1 212 x 605 x 57	Blanco	1



LEDVANCE® SPOTLIGHT

Luminaria de techo para empotrar tipo spot, utilizada para destacar objetos o ambientes. Lámpara ajustable con recubrimiento antirreflejante, ideal para iluminación decorativa en establecimientos, oficinas, centros comerciales y hoteles. Acabado en blanco mate.

Ceiling luminaire to embed, spot type. It is used to highlight objects or environments. Adjustable lamp with anti-glare coating. It is ideal for decorative lighting in shops, offices, shopping centers. In matt white.



- HASTA 90% DE AHORRO DE ENERGÍA**
- 3 AÑOS DE GARANTÍA**
- 100 - 240 V~**
- IP 20**
- RECUBRIMIENTO ANTIRREFLEJANTE**
- LÁMPARA AJUSTABLE**
- LED COB**
- DRIVER PLUG & PLAY**

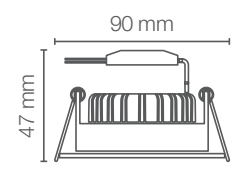

APLICACIONES / APPLICATIONS

- Oficinas
Offices
- Establecimientos
Shops
- Bar/
Restaurantes
Restaurants
- Hoteles
Hotels
- Museos/Galerías
Museums/Galleries

Código Sku	Potencia Power (W)	Equivalencia Equivalence Halógena (W)	Flujo Luminoso Luminous Flux (lm)	Ángulo de Apertura Opening Angle	Temp. de Color Color Temp. (K)	IRC CRI	Vida Útil Life (h)	Dimensiones Dimensions (mm)	Color de Producto Product Color	Unidades por Caja Units per box
82876	10	75	800	36°	3000	>80	30 000	Ø 90 x 47	Blanco	20
85271	10	75	800	36°	6500	>80	30 000	Ø 90 x 47	Blanco	20

* En sustitución de lámparas halógenas convencionales / In replacement of conventional halogen lamps.



LEDVANCE® SPOTLIGHT MODULAR

Luminaria de techo para empotrar tipo spot con LED COB de alta calidad que realza perfectamente el color de los objetos alcanzados hasta 1,800 lúmenes. Combinándolo con alguno de sus 9 accesorios en acabado blanco mate puedes crear hasta 36 combinaciones diferentes para lucir espacios creativos y espectaculares.

Spot-type embed ceiling luminaire with high quality COB LED that perfectly enhances the color of objects, reaching up to 1,800 lumens. Combining it with one of its 9 accessories in matte white finish, you can create up to 36 combinations to design creative and spectacular spaces.

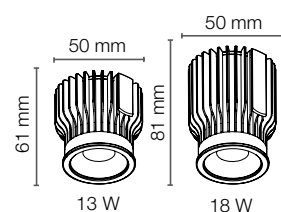

APLICACIONES / APPLICATIONS



Código Sku	Potencia Power (W)	Equivalencia Equivalence Halógena (W)	Flujo Luminoso Luminous Flux (lm)	Ángulo de Apertura Opening Angle	Temp. de Color Color Temp. (K)	IRC CRI	Vida Útil Life (h)	Dimensiones Dimensions (mm)	Color de Producto Product Color	Unidades por Caja Units per box
80697	13	1 X 90	1 105	36°	● 3000	>80	50 000	Ø50 x 61	Negro	20
80698	13	1 X 90	1 210	36°	○ 4000	>80	50 000	Ø50 x 61	Negro	20
80699	18	1 X 150	1 700	36°	● 3000	>80	50 000	Ø50 x 81	Negro	20
80700	18	1 X 150	1 800	36°	○ 4000	>80	50 000	Ø50 x 81	Negro	20

*En sustitución de lámparas halógenas convencionales / In replacement of conventional halogen.

Código Sku	Versión	Tamaño de corte	Material	Peso Weight (g)	Dimensiones Dimensions (mm)	Color de Producto Product Color	Unidades por Caja Units per box
80701	DEEP TRIM	Ø80	Aluminio	75	Ø85 x 46.8	Blanco	20
80702	OVAL HOLE TRIM	Ø80	Aluminio	110	Ø85 x 34.5	Blanco	20
80704	TILT TRIM	Ø80	Aluminio	70	Ø90 x 24.8	Blanco	20
80705	DEEP TRIM	Ø95	Aluminio	90	Ø100 x 45.8	Blanco	20
80706	ASYMMETRICAL TRIM	Ø95	Aluminio	95	Ø100 x 64	Blanco	20
80709	SQUARE TILT TRIM	Ø95	Aluminio	160	Ø110 x 35	Blanco	20



DEEP TRIM Ø80



DEEP TRIM Ø95



OVAL HOLE TRIM Ø80



ASYMMETRICAL TRIM Ø95



TILT TRIM Ø80



SQUARE TILT TRIM Ø95

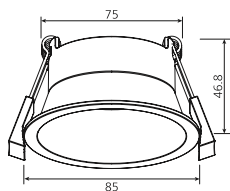

DEEP TRIM Ø80

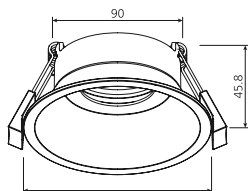

DEEP TRIM Ø95

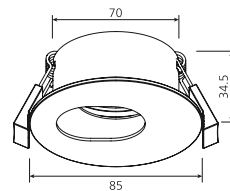

OVAL HOLE TRIM Ø80

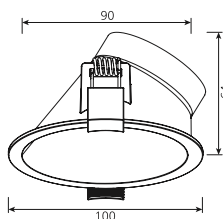

ASYMMETRICAL TRIM Ø95

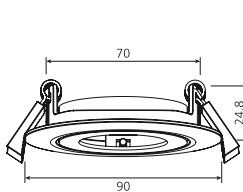

TILT TRIM Ø80

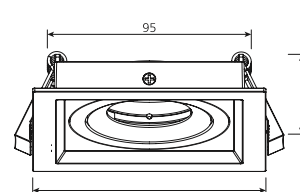



LEDVANCE® SPOTLIGHT VARIO

Nuevo SPOTLIGHT VARIO, luminaria para empotrar con cabezal direccionable y ajustable. Puede ser utilizado como un downlight clásico (con el cabezal completamente empotrado), como bañador de pared (con el cabezal inclinado) o para proporcionar iluminación de fondo y de acento ya que es extremadamente versátil. Ideal para espacios con techos altos, para aquellos que buscan una iluminación excepcional.

New SPOTLIGHT VARIO, recessed luminaire with an addressable and adjustable head. It can be used as a classic downlight (with fully recessed head), as a wallwasher (with tilted head) or to provide background and accent lighting as it is extremely versatile. Ideal for spaces with high ceilings, for those looking for exceptional lighting.

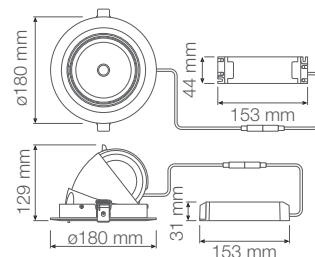

APLICACIONES / APPLICATIONS



Código Sku	Potencia Power (W)	Equivalencia Equivalence CFL (W)	Flujo Luminoso Luminous Flux (lm)	Ángulo de Apertura Opening Angle	Temp. de Color Color Temp. (K)	Vida Útil Life (h)	IRC CRI	Dimensiones Dimensions (mm)	Color de Producto Product Color	Unidades por Caja Units per box
85801	35	2 x 42 CFL	3 350	24°	● 3000	50 000	>80	Ø 180 x 128	Blanco	4
85802	35	2 x 42 CFL	3 550	24°	○ 4000	50 000	>80	Ø 180 x 128	Blanco	4

* En sustitución de lámparas fluorescentes compactas no integradas / In the replacement of non-integrated compact fluorescent lamps.



LEDVANCE® DOWNLIGHT

Luminaria de techo para empotrar, ideal para ambientes profesionales.
Acabado en aluminio blanco mate.

Ceiling luminaire to embed. It is ideal for professional environments. Finished in matt white aluminum.



HASTA
60%
DE AHORRO
DE ENERGÍA

3
AÑOS DE
GARANTÍA

100 - 277 V~

DIFUSOR DE
ALTA CALIDAD

IP20
IP54

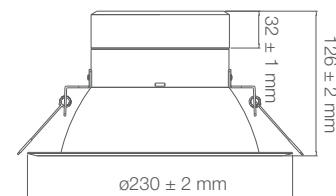

31 W / 40 W

APLICACIONES / APPLICATIONS

Oficinas
Offices

Ambientes residenciales
Residential environments

Establecimientos
Shops

Hoteles
Hotels

Museos/Galerías
Museums/Galleries

Sala de juntas
Meeting rooms

Pasillos
Corridors

Código SKU	Potencia Power (W)	Equivalencia Equivalence CFL (W)	Flujo Luminoso Luminous Flux (lm)	Ángulo de Apertura Opening Angle	Temp. de Color Color Temp. (K)	IRC CRI	Vida Útil Life (h)	Dimensiones Dimensions (mm)	Color de Producto Product Color	Unidades por Caja Units per box
86709	25	2 x 32	2 200	100°	● 3000	>80	30 000	Ø 215 x 61	Blanco	8
88890	31	2 x 32	3 100	80°	○ 4000	>80	50 000	Ø 230 x 126	Blanco	6
88891	31	2 x 32	3 100	80°	● 6500	>80	50 000	Ø 230 x 126	Blanco	6
88892	40	2 x 42	4 000	80°	○ 4000	>80	50 000	Ø 230 x 126	Blanco	6
88893	40	2 x 42	4 000	80°	● 6500	>80	50 000	Ø 230 x 126	Blanco	6

* En sustitución de lámparas fluorescentes compactas no integradas / In the replacement of non-integrated compact fluorescent lamps.



LEDVANCE® DOWNLIGHT PARA BOTE INTEGRAL

Luminaria con controlador integrado para su aplicación en bote integral de 8 cm y 12 cm. Con construcción en aluminio y difusor en policarbonato lo que permite una distribución uniforme de luz. Disponible en 6 500 K y además una versión atenuable.

Luminaire with integrated controller for application in 8 cm and 12 cm integral boat. With construction in aluminum and diffuser in polycarbonate that allows a uniform distribution of light. Available in 6 500 K and also an dimmable version.



HASTA
60%
DE AHORRO
DE ENERGÍA

3
AÑOS DE
GARANTÍA

ATENUABLE
A FASE

IP 20

100 - 277 V~

120 V~

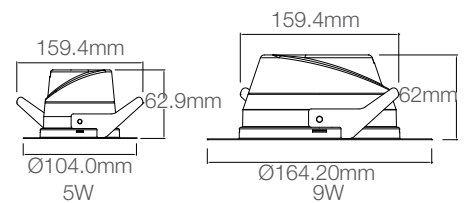

APLICACIONES / APPLICATIONS



Código SKU	Potencia Power (W)	Equivalencia Equivalence CFLI (W)	Flujo Luminoso Luminous Flux (lm)	Ángulo de Apertura Opening Angle	Temp. de Color Color Temp. (K)	Vida Útil Life (h)	IRC CRI	Dimensiones Dimensions (mm)	Color de Producto Product Color	Unidades por Caja Units per box
80304	5	1 x 13	400	110°	6500	30 000	>80	Ø104x629	Blanco	12
80307	9	2 x 13	720	110°	6500	30 000	>80	Ø164.2x620	Blanco	12
80310	5	1 x 13	400	110°	6500	30 000	>80	Ø104x629	Blanco	12

* En sustitución de lámparas CFLI compactas / In the replacement of compact CFLI lamps.



LEDVANCE® DOWNLIGHT RT

Luminaria LED de gran versatilidad y excelente especificación, ideal para proyectos que demanden iluminación de primer nivel, ofrece compatibilidad para la implementación con sistemas de control y atenuadores.

LED luminaire of great versatility and excellent specification, ideal for projects that require first-class lighting, it offers compatibility for implementation with control systems and dimmers.



IRC >90

3 POTENCIAS SELECCIONABLES

TEMPERATURA 4 EN 1

IP44

0 10 ATENUABLE

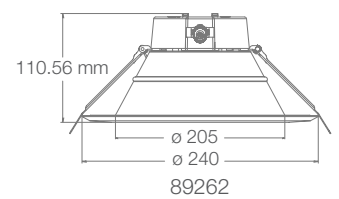
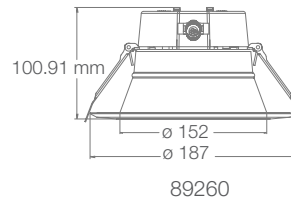

APLICACIONES / APPLICATIONS

Oficinas
Offices

Ambientes residenciales
Residential environments

Establecimientos
Shops

Hoteles
Hotels

Museos
Museums

Sala de juntas
Meeting rooms

Pasillos
Corridors

Código Sku	Potencia Seleccionable Selectable Power (W)	Flujo Luminoso Luminous Flux (lm)	Ángulo de Apertura Opening Angle	Temp. de Color Color Temp. (K)	Vida Útil Life (h)	IRC CRI	Dimensiones Dimensions (mm)	Color de Producto Product Color	Unidades por Caja Units per box
89260	7W/9W/11W	500 / 700 / 900	85°	<ul style="list-style-type: none"> ● 3000 ● 3500 ○ 4000 ● 5000 	50 000	>90	Ø 187 x 101	Blanco	4
89262	25W/29W/35W	2 400 / 2 800 / 3 300	90°	<ul style="list-style-type: none"> ● 3000 ● 3500 ○ 4000 ● 5000 	50 000	>90	Ø 240 x 110	Blanco	4



LEDVANCE® LINEAR

Luminaria de techo para sobreponer con diseño lineal y moderno. Equipada con LED de alta potencia, que ilumina el ambiente de manera uniforme. Disponible en temperaturas de color: Luz Cálida (3000 K), Blanco Frío (4000 K) y Luz de Día (6500 K).

Indoor lighting with a linear and modern design. Equipped with high power led with day light and cool light, it lights up uniformly the environment. Easy and fast installing. Available in versions: Warm Light (3000 K), Cool Light (4000 K) and Day Light (6500 K).

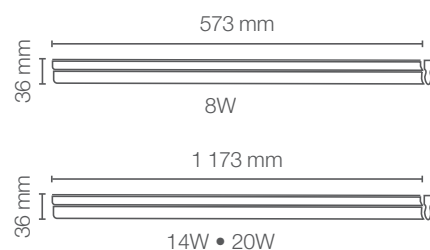

APLICACIONES / APPLICATIONS



Código Sku	Potencia Power (W)	Equivalencia Equivalence Fluor. (W)	Flujo Luminoso Luminous Flux (lm)	Ángulo de Apertura Opening Angle	Temp. de Color Color Temp. (K)	IRC CRI	Vida Útil Life (h)	Dimensiones Dimensions (mm)	Color de Producto Product Color	Unidades por Caja Units per box
86510	8	1 x 17 T8	800	100°	● 3000	>80	30 000	573 x 28 x 36	Blanco	15
86398	8	1 x 17 T8	800	100°	○ 4000	>80	30 000	573 x 28 x 36	Blanco	15
86399	8	1 x 17 T8	800	100°	● 6500	>80	30 000	573 x 28 x 36	Blanco	15
86512	14	1 x 25 T8	1 400	100°	● 3000	>80	30 000	1173 x 28 x 36	Blanco	15
86400	14	1 x 25 T8	1 400	100°	○ 4000	>80	30 000	1173 x 28 x 36	Blanco	15
86401	14	1 x 25 T8	1 400	100°	● 6500	>80	30 000	1173 x 28 x 36	Blanco	15
86514	20	1 x 32 T8	2 000	100°	● 3000	>80	30 000	1173 x 28 x 36	Blanco	15
86402	20	1 x 32 T8	2 000	100°	○ 4000	>80	30 000	1173 x 28 x 36	Blanco	15
86403	20	1 x 32 T8	2 000	100°	● 6500	>80	30 000	1173 x 28 x 36	Blanco	15

* En sustitución de lámparas fluorescentes tubulares / In replacement of tubular fluorescent lamps.



LEDVANCE® LINEAR BATTEN T5

Su aplicación versátil te permitirá crear estructuras de iluminación homogénea, ya sea de manera general o decorativa e incluso podrás instalar en mobiliario que requiera realzar fielmente los colores gracias a su alto índice de reproducción cromática >90.

Aporta iluminación continua y sin sombras gracias a su sistema de interconexión lineal con el cual podrás tener hasta 10 luminarias.

Its versatile application will allow you to create homogeneous lighting structures, either in a general or decorative way and you can even install it in furniture that needs to faithfully enhance colors thanks to its high color rendering index >90.

Provides continuous lighting without shadows thanks to its linear interconnection system with which you can have up to 10 luminaires.

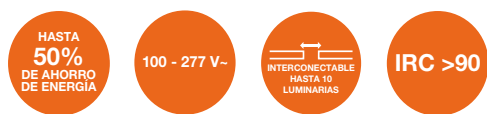

APLICACIONES / APPLICATIONS



Código Sku	Potencia Power (W)	Equivalencia Equivalence Fluor. (W)	Flujo Luminoso Luminous Flux (lm)	Ángulo de Apertura Opening Angle	Temp. de Color Color Temp. (K)	IRC CRI	Vida Útil Life (h)	Dimensiones Dimensions (mm)	Color de Producto Product Color	Unidades por Caja Units per box
88974	13	1 x 25	1 300	180°	4000	>90	50 000	870 x 225 x 36	Blanco	25

* En sustitución de lámparas fluorescentes tubulares / In replacement of tubular fluorescent lamps.



LEDVANCE® LINEAR PENDANT

Luminaria de techo para suspender, ahora con mayor eficacia que le garantiza la mejor iluminación para espacios comerciales y corporativos, luzca un ambiente elegante y sofisticado gracias a su iluminación directa e indirecta la cual a su vez ayuda a mitigar el efecto caverna.

Ceiling luminaire to suspend, now with greater efficiency that guarantees the best lighting for commercial and corporate spaces, looks elegant and sophisticated thanks to its direct and indirect lighting which in turn helps to mitigate the cavern effect.

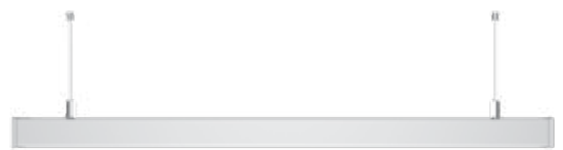

- HASTA
40%
DE AHORRO
DE ENERGÍA
- 5
AÑOS DE
GARANTÍA
- 100 - 277 V-
- IP20
- IK06
- LUZ DIRECTA
E INDIRECTA

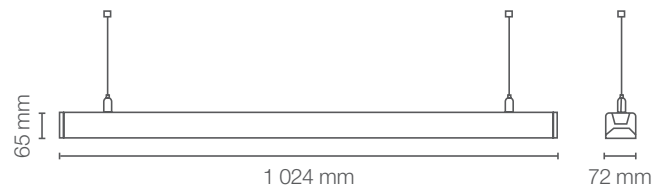

APLICACIONES / APPLICATIONS



Código SKU	Potencia Power (W)	Equivalencia Equivalence Fluor. (W)	Flujo Luminoso Luminous Flux (lm)	Ángulo de Apertura Opening Angle	Temp. de Color Color Temp. (K)	IRC CRI	Vida Útil Life (h)	Dimensiones Dimensions (mm)	Color de Producto Product Color	Unidades por Caja Units per box
80179	36	2 x 28W T5 0 2 x 32W T8	3 300	110°	○ 4000	>80	50 000	1024 x 72 x 65	Blanco	6

* En sustitución de lámparas fluorescentes tubulares / In replacement of tubular fluorescent lamps.



LEDVANCE® MULTI LINEAR

Juega con los contrastes de luz y sombra seleccionando entre sus 3 diferentes temperaturas de color y transforma la iluminación tradicional en una nueva experiencia de luminosidad creando confort y armonía. Elige entre sus diferentes modalidades de instalación: Suspendido, Sobrepuesto en techo y Sobrepuesto en Pared. Complementa tu instalación con los conectores en L y X que te permitirán crear grandes estructuras de iluminación continua.

Play with the contrasts of light and shadow by selecting between its 3 different color temperatures and transform traditional lighting into a new light experience creating comfort and harmony. Choose between its different installation modes: Suspended, Ceiling-mounted and Wall-mounted. Complement your installation with the L and X connectors that will allow you to create large continuous lighting structures.



- HASTA
40%
DE AHORRO
DE ENERGÍA**
- 36W**
- 100 - 277 V-**
- INTERCONECTABLE**
- 3
TEMPERATURAS
EN 1**
- 0 10
ATENUABLE**



APLICACIONES / APPLICATIONS



Código Sku	Potencia Power (W)	Equivalencia Equivalence Fluor. (W)	Flujo Luminoso Luminous Flux (lm)	Ángulo de Apertura Opening Angle	Temp. de Color Color Temp. (K)	IRC CRI	Vida Útil Life (h)	Dimensiones Dimensions (mm)	Color de Producto Product Color	Unidades por Caja Units per box
------------	--------------------	-------------------------------------	-----------------------------------	----------------------------------	--------------------------------	---------	--------------------	-----------------------------	---------------------------------	---------------------------------



88824	36	2 x 28W T5 o 2 x 32W T8	3 600	110°	● 3000 ○ 4000 ● 5700	>80	50 000	1212 x 57 x 76	Blanco	6
-------	----	-------------------------------	-------	------	----------------------------	-----	--------	----------------	--------	---



* Se venden por separado / They are sold separately.

* En sustitución de lámparas fluorescentes tubulares / In replacement of tubular fluorescent lamps.

Accesorios* Accessories*	Código	Descripción	Dimensiones
	88825	Conector X	343 x 343 x 76
	88826	Conector L	200 x 200 x 76
	88827	Montaje de Pared	56.5 x 20 x 20
	88828	Kit de suspensión	Ø 15 x 1000



LEDVANCE® MULTI ROUND

Juega con los contrastes de luz y sombra, transformando la iluminación tradicional en una nueva experiencia de luminosidad creando confort y armonía. Permite instalación empotrada, sobrepuesta o en muro.

Play with contrasts of light and shadow, transforming traditional lighting into a new experience of luminosity, creating comfort and harmony. Allows recessed, surface-mounted or wall installation.

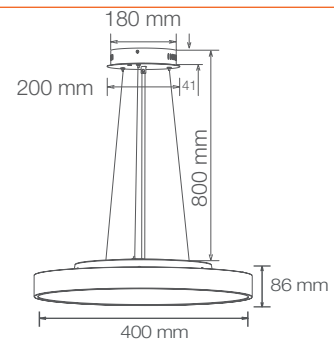

APLICACIONES / APPLICATIONS



Código Sku	Potencia Power (W)	Flujo Luminoso Luminous Flux (lm)	Ángulo de Apertura Opening Angle	Temp. de Color Color Temp. (K)	IRC CRI	Vida Útil Life (h)	Dimensiones Dimensions (mm)	Color del Producto Product Color	Unidades por caja Units per box
88830	40	3 500	120°	● 3000	>80	50 000	Ø 400 x 86	Negro	6
88831	40	4 300	120°	○ 4000	>80	50 000	Ø 400 x 86	Negro	6



Accesorios*
Accessories*

88832

Kit de suspensión

Ø15 x 1000

* Se venden por separado / They are sold separately.



LEDVANCE® LOWBAY

Luminaria con diseño ligero y compacto que se puede integrar en cualquier espacio proporcionando una apariencia más discreta y estética. Su alta eficacia de 135 lm/W permite reducir el consumo de energía hasta un 60% en comparación con tecnología tradicional. Cuenta con protocolo de atenuación que permitirá integrarla a un sistema de control alámbrico o inalámbrico de acuerdo a la preferencia del cliente.

Light and compact design luminaire, can be integrated into any space providing a more discreet and aesthetic appearance. Its high efficiency of 135 lm/W allows energy consumption to be reduced by up to 60% compared to traditional technology. It has an attenuation protocol that will allow it to be integrated into a wired or wireless control system according to the customer's preference.



HASTA
50%
DE AHORRO
DE ENERGÍA

5

AÑOS DE
GARANTÍA

100 – 277 V~

1 10V
ATENUABLE

IP44

IK06

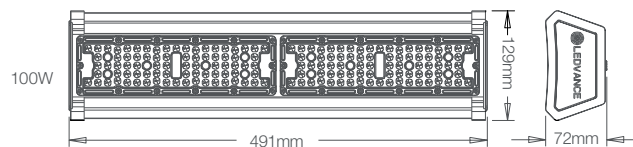
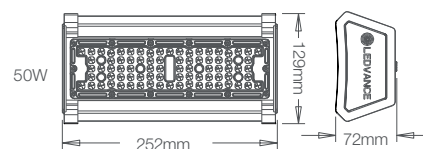

APLICACIONES / APPLICATIONS

- Supermercados
Supermarket
- Establecimientos
Shops
- Pasillos
Corridors
- Bodegas
Wineries

Código Sku	Potencia Power (W)	Equivalencia Equivalence Fluor. T5 (W)	Flujo Luminoso Luminous Flux (lm)	Ángulo de Apertura Opening Angle	Temp. de Color Color Temp. (K)	IRC CRI	Vida Útil Life (h)	Dimensiones Dimensions (mm)	Color de Producto Product Color	Unidades por Caja Units per box
80153	50	2 x 54	6 750	90°	● 5000	>80	50 000	269 x 128 x 60	Gris	10
80154	100	4 x 54	13 500	90°	● 5000	>80	50 000	526 x 128 x 60	Gris	6

* En sustitución de lámparas fluorescentes tubulares / In replacement of tubular fluorescent lamps.



LEDVANCE® PENDULUM

Accesorio para lámparas LED e Incandescentes con base E27 ideal para crear una atmósfera clásica y retro. Combinable con diferentes ambientes y propuestas decorativas.

Accessory for LED and incandescent lamps with E27 base ideal to create a classic and retro atmosphere. Combination with different environments and decorative proposals.



*Lámpara no incluida

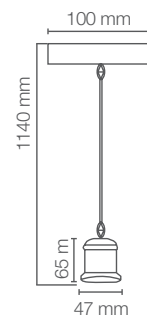

APLICACIONES / APPLICATIONS

- Salas
Livings
- Recámaras
Rooms
- Áreas Gastronómicas
Gastronomic areas
- Restaurantes
Restaurants
- Establecimientos
Shops

Compatible con nuestra línea de lámparas LED VINTAGE 1906.

Código Sku	Material	Potencia Max. Max. Power (W)	Base	Dimensiones Dimensions (mm)	Color de Producto Product Color	Unidades por Caja Units per box
83960	Acero	LED 31W o INCANDESCENTE 40W	E27	Ø 47 x 1140	Negro	12
83961	Acero	LED 31W o INCANDESCENTE 40W	E27	Ø 47 x 1140	Bronce	12



LEDVANCE® PENDULUM INDUSTRIAL & RETRO

Aporta dinamismo a tus espacios, agrega un acento nostálgico y crea la experiencia perfecta, éstas apuestas de auténtico diseño hacen un guiño cómplice al pasado, pero con una mirada firme hacia el futuro.

PENDULUM INDUSTRIAL: Es perfecta por tener un punto de luz específico, y conseguir una decoración urbana la cual se caracteriza por dejar estructuras visibles, ladrillos, vigas de acero, techos altos y grandes ventanales.

PENDULUM RETRO: Estilo cálido y eficiente que complementa con naturalidad cualquier tipo de diseño de iluminación ya sea vintage, rústico, moderno o vanguardista generando un ambiente único.

Bring dynamism to your spaces, add a nostalgic accent and create the perfect experience, these bets of authentic design make a complicit nod to the past, but with a firm look towards the future.

PENDULUM INDUSTRIAL: It is perfect for having a specific point of light, and achieving an urban decoration which is characterized by leaving visible structures, bricks, steel beams, high ceilings and large windows.

PENDULUM RETRO: Warm and efficient style that naturally complements any type of lighting design, whether vintage, rustic, modern or avant-garde, generating a unique atmosphere.



INDUSTRIAL



RETRO

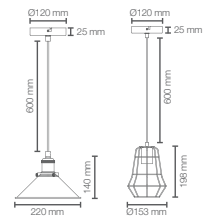

APLICACIONES / APPLICATIONS



Compatible con nuestra línea de lámparas LED VINTAGE 1906.

Código Sku	Material	Potencia Max. Max. Power (W)	Base	Dimensiones Dimensions (mm)	Color de Producto Product Color	Unidades por Caja Units per box
88870	Aluminio	40	E27	Ø 220 x 820	Negro / Dorado	12
88871	Aluminio	40	E27	Ø 153 x 860	Negro	12



LEDVANCE® STRING LIGHT

Decora e inspira tus espacios exteriores con una iluminación suave que asombre e incite a entrar a tu establecimiento a clientes potenciales. Cuenta con 7 metros de largo que te permitirán una excelente distribución de iluminación por todo el lugar, además podrás interconectar una tras otra ampliando las posibilidades.

Combina distintos estilos de iluminación para crear una amalgama única y original que genere un sello de identidad propio creando ambientes acogedores y tranquilos logrando que los usuarios se desconecten del mundo exterior y de la rutina, regalándose a sí mismos un momento de relajación alejado de las prisas y el estrés.

Decorate and inspire your outdoor spaces with soft lighting that will amaze and entice potential customers to enter your establishment. It is 7 meters long that will allow you an excellent distribution of lighting throughout the place, you can also interconnect one after another, expanding the possibilities.

It combines different styles of lighting to create a unique and original amalgam that generates a stamp of its own identity, creating cozy and quiet environments, making users disconnect from the outside world and routine, giving themselves a moment of relaxation away from the rush and stress.

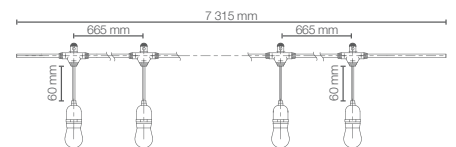
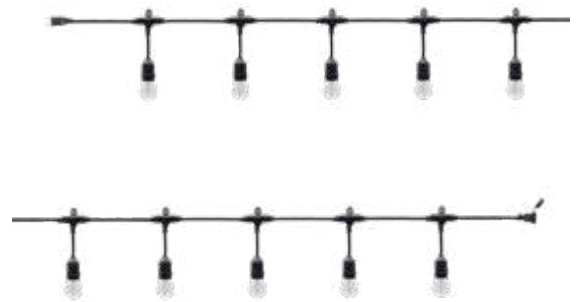

APLICACIONES / APPLICATIONS



Código Sku	Potencia Power (W)	Flujo Luminoso Luminous Flux (lm)	Ángulo de Apertura Opening Angle	Temp. de Color Color Temp. (K)	IRC CRI	Vida Útil Life (h)	Dimensiones Dimensions (mm)	Color de Producto Product Color	Unidades por Caja Units per box
88872	0.8 x 10	60 x 10	270°	2700	>80	30 000	7310 x 33.2 x 130	Negro	2



LEDVANCE® TRACKLIGHT

Es una tendencia en la iluminación a detalle, adecuada para aplicaciones comerciales, con una iluminación moderna y decorativa. Ideal para enfocar objetos y destacar espacios.

A trend towards lighting in detail, it is suitable for commercial applications, with modern and decorative lighting, ideal for focusing objects and highlighting spaces.



- 3**
AÑOS DE GARANTÍA
- MATERIAL ALUMINIO**
- E27**
- GU10**
- 2**
COLORES
- LÁMPARA NO INCLUIDA**

*Lámpara no incluida

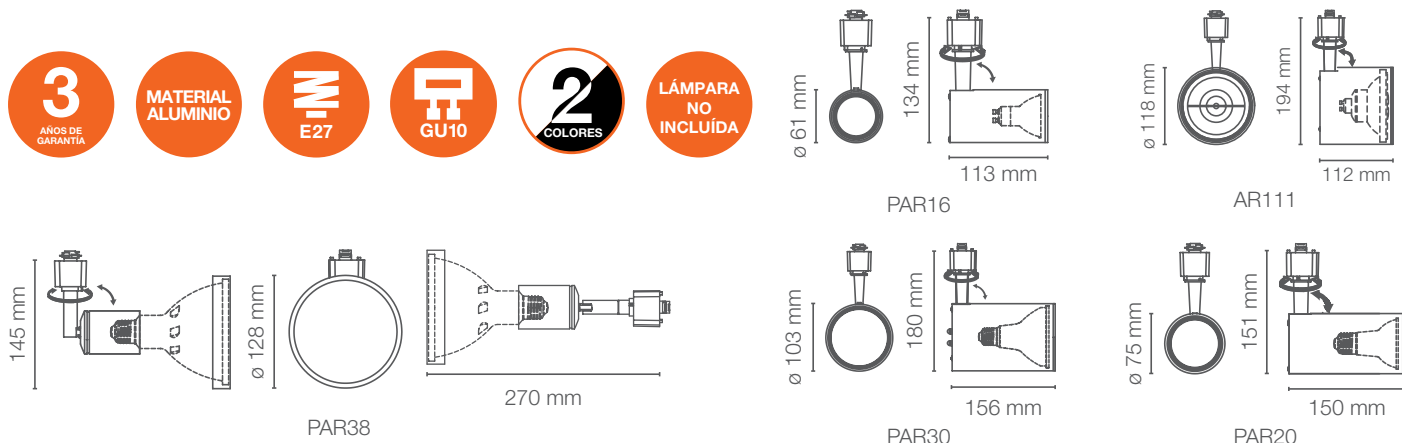

APLICACIONES / APPLICATIONS



Compatible con nuestra línea de lámparas LED SUPERSTAR.

Código Sku	Versión	Material	Potencia Max. Max. Power (W)	Base	Dimensiones Dimensions (mm)	Peso Weight (g)	Color de Producto Product Color	Unidades por caja Units per box
86636	AR111	Aluminio	14	GU10	112 x 118 x 194	440	Negro	12
86637	AR111	Aluminio	14	GU10	112 x 118 x 194	440	Blanco	12
86632	PAR16	Aluminio	11	GU10	113 x 61 x 134	235	Negro	12
86633	PAR16	Aluminio	11	GU10	113 x 61 x 134	235	Blanco	12
86638	PAR20	Aluminio	7	E27	150 x 75 x 151	340	Negro	12
86639	PAR20	Aluminio	7	E27	150 x 75 x 151	340	Blanco	12
86640	PAR30 LN	Aluminio	31	E27	156 x 103 x 180	425	Negro	12
86641	PAR30 LN	Aluminio	31	E27	156 x 103 x 180	425	Blanco	12
86644	PAR38	Aluminio	16	E27	270 x 128 x 145	288	Negro	12
86645	PAR38	Aluminio	16	E27	270 x 128 x 145	288	Blanco	12

RIELES Y CONECTORES / RAILS AND CONNECTORS



RIELES / RAILS

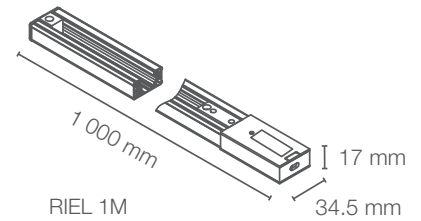
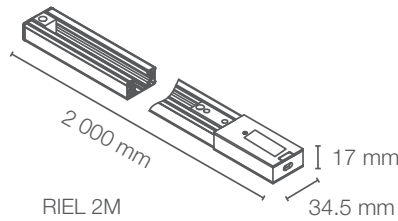

Código Sku	Versión	Material	Potencia Max. Max. Power (W)	Dimensiones Dimensions (mm)	Peso Weight (g)	Color del Producto Product Color	Spots Max. Por Riel Max. Spots Per Rail	Unidades por caja Units per box
86646	Riel 1M	Aluminio	190	1000 x 34.5 x 17	500	Negro	AR111 - 6 PAR16 - 6 PAR20 - 6 PAR30 LN - 4 PAR38 - 4	12
86647	Riel 1M	Aluminio	190	1000 x 34.5 x 17	500	Blanco	AR111 - 6 PAR16 - 6 PAR20 - 6 PAR30 LN - 4 PAR38 - 4	12
86648	Riel 2M	Aluminio	190	2000 x 34.5 x 17	1000	Negro	AR111 - 11 PAR16 - 11 PAR20 - 11 PAR30 LN - 7 PAR38 - 7	12
86649	Riel 2M	Aluminio	190	2000 x 34.5 x 17	1000	Blanco	AR111 - 11 PAR16 - 11 PAR20 - 11 PAR30 LN - 7 PAR38 - 7	12

CONECTORES / CONNECTORS

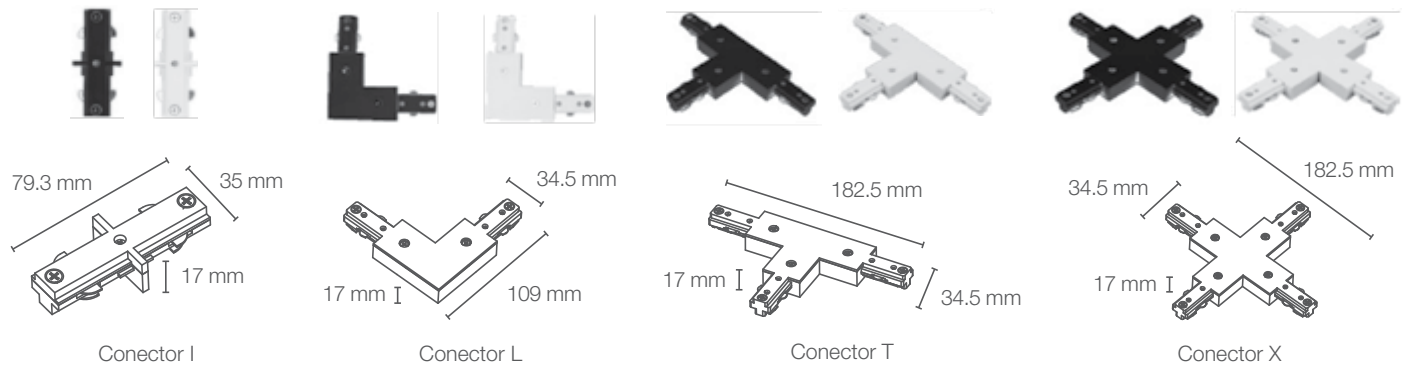

Código Sku	Versión	Material	Potencia Max. Max. Power (W)	Dimensiones Dimensions (mm)	Peso Weight (g)	Color del Producto Product Color	Unidades por caja Units per box
86650	Conector I	Aluminio	190	79.3 x 35 x 17	28	Negro	12
86651	Conector I	Aluminio	190	79.3 x 35 x 17	28	Blanco	12
86652	Conector L derecho	Aluminio	190	109 x 34.5 x 17	104	Negro	12
86653	Conector L derecho	Aluminio	190	109 x 34.5 x 17	104	Blanco	12
86758	Conector L izquierdo	Aluminio	190	109 x 34.5 x 17	104	Negro	12
86759	Conector L izquierdo	Aluminio	190	109 x 34.5 x 17	104	Blanco	12
86722	Conector T derecho	Aluminio	190	182.5 x 34.5 x 17	148	Negro	12
86723	Conector T derecho	Aluminio	190	182.5 x 34.5 x 17	148	Blanco	12
86760	Conector T izquierdo	Aluminio	190	182.5 x 34.5 x 17	148	Negro	12
86761	Conector T izquierdo	Aluminio	190	182.5 x 34.5 x 17	148	Blanco	12
86724	Conector X	Aluminio	190	182.5 x 34.5 x 17	196	Negro	12
86725	Conector X	Aluminio	190	182.5 x 34.5 x 17	196	Blanco	12

RECESSED RAIL & FLEXIBLE CONNECTOR



RIEL PARA EMPOTRAR / RECESSED RAIL

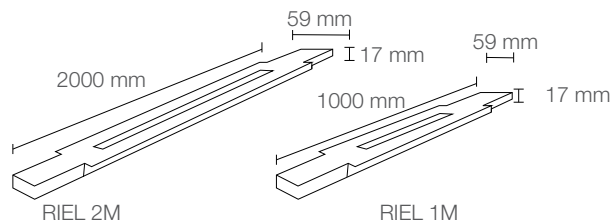

Código Sku	Versión	Material	Potencia Max. Max. Power (W)	Dimensiones Dimensions (mm)	Peso Weight (g)	Color del Producto Product Color	Spots Max. Por Riel Max. Spots Per Rail	Unidades por caja Units per box
80215	Riel 1M	Aluminio	190	1000x59x17	575	Blanco	AR111 - 6 PAR16 - 6 PAR20 - 6 PAR30 LN - 4 PAR38 - 4	12
80216	Riel 2M	Aluminio	190	2000x59x17	1120	Negro	AR111 - 11 PAR16 - 11 PAR20 - 11 PAR30 LN - 7 PAR38 - 7	12
80217	Riel 2M	Aluminio	190	2000x59x17	1120	Blanco	AR111 - 11 PAR16 - 11 PAR20 - 11 PAR30 LN - 7 PAR38 - 7	12

CONECTOR FLEXIBLE / FLEXIBLE CONNECTOR

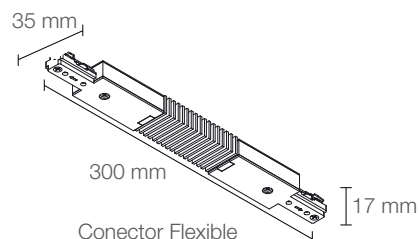

Código Sku	Versión	Material	Potencia Max. Max. Power (W)	Dimensiones Dimensions (mm)	Peso Weight (g)	Color del Producto Product Color	Unidades por caja Units per box
80218	Conector Flexible	Aluminio	190	300 x 35 x 17	155	Negro	12
80219	Conector Flexible	Aluminio	190	300 x 35 x 17	155	Blanco	12



LEDVANCE® TRACKLIGHT ZOOM

Su diseño SCALE exclusivo de LEDVANCE y su módulo de LED de 25 W de alta reproducción cromática, lo convierten en la solución en iluminación de acento más versátil y completa para aplicaciones comerciales, destacando espacios y enfocando objetos adecuándose a sus necesidades con sus 4 tipos de ajuste: rotación, inclinación, atenuación y acentuación.

Its exclusive SCALE design from LEDVANCE and its high color rendering 25W LED module, make it the most versatile and complete accent lighting solution for commercial applications, highlighting spaces and focusing objects according to your needs with its 4 types of adjustment: rotation angle, tilt angle, dimmable and beam angle.

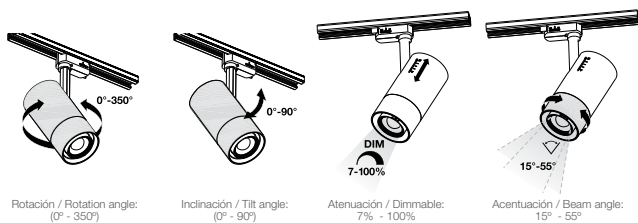

Rotación / Rotation angle: (0° - 350°)

Inclinación / Tilt angle: (0° - 90°)

Atenuación / Dimmable: 7% - 100%

Acentuación / Beam angle: 15° - 55°

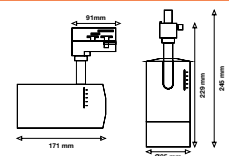

25 W

APLICACIONES / APPLICATIONS



Código Sku	Potencia Power (W)	Equivalencia Equivalence Halógena (W)	Flujo Luminoso Luminous Flux (lm)	Ángulo de Apertura Opening Angle (lm)	Temp. de Color Color Temp. (K)	IRC CRI	Vida Útil Life (h)	Dimensiones Dimensions (mm)	Color de Producto Product Color	Unidades por caja Units per box
80625	25	1 X 90	1 500	15° - 55°	● 3000	97	50 000	93 x 85 x 265	Blanco	4
80626	25	1 X 90	1 500	15° - 55°	○ 4000	97	50 000	93 x 85 x 265	Blanco	4
80627	25	1 X 90	1 500	15° - 55°	● 3000	97	50 000	93 x 85 x 265	Negro	4
80628	25	1 X 90	1 500	15° - 55°	○ 4000	97	50 000	93 x 85 x 265	Negro	4

*En sustitución de lámparas halógenas convencionales / In replacement of conventional halogen lamps.



LEDVANCE® TRACKLIGHT SPOT ZOOM

Brinde un esquema de iluminación personalizado que denote confort y clase con la cantidad adecuada de luz uniforme y limpia. Cautive a los clientes con efectos que mejoran la percepción de colores y texturas gracias a su alto índice de reproducción cromática.

Provide a custom lighting scheme that denotes comfort and class with the right amount of clean, uniform light. Captivate customers with effects that improve the perception of colors and textures thanks to their high color rendering index.



BLOQUEAR / DESBLOQUEAR

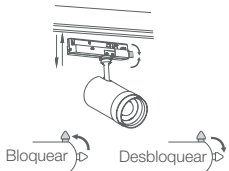

INCLINACIÓN Y ROTACIÓN

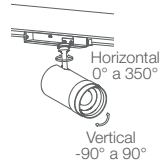

ACENTUACIÓN

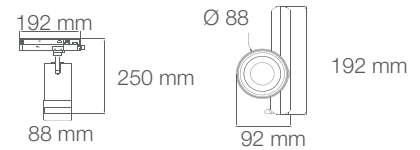
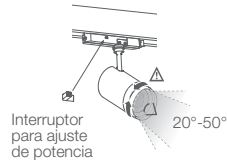

28W / 33W / 38W

APLICACIONES / APPLICATIONS



Código Sku	Potencia Seleccionable Selectable Power (W)	Flujo Luminoso Luminous Flux (lm)	Ángulo de Apertura Opening Angle	Temp. de Color Color Temp. (K)	IRC CRI	Vida Útil Life (h)	Dimensiones Dimensions (mm)	Color de Producto Product Color	Unidades por Caja Units per box
89927	28W / 33W / 38W	2300 lm / 2700 lm / 3000 lm	20°- 50°	● 3000	> 90	50 000	Ø 88x192	Blanco	6
89928	28W / 33W / 38W	2600 lm / 3000 lm / 3400 lm	20°- 50°	○ 4000	> 90	50 000	Ø 88x192	Blanco	6
89929	28W / 33W / 38W	2300 lm / 2700 lm / 3000 lm	20°- 50°	● 3000	> 90	50 000	Ø 88x192	Negro	6
89930	28W / 33W / 38W	2300 lm / 2700 lm / 3000 lm	20°- 50°	○ 4000	> 90	50 000	Ø 88x192	Negro	6



LEDVANCE® EMERGENCY LIGHT 2X1W

A la hora de iluminar un pasillo o un área de tránsito, es primordial tener en cuenta la implementación de sistemas de emergencia que brinden las condiciones adecuadas de orientación, visibilidad y seguridad ante cortes de energía o siniestros. Esta nueva luminaria de emergencia incorpora un diseño robusto en materiales de alta resistencia autoextinguibles en caso de exposición al fuego, cuenta con 2 cabezales LED ajustables ultrabrillantes que permiten direccionar la iluminación para un máximo aprovechamiento. Su batería integrada de Níquel-Cadmio le permitirá un funcionamiento mínimo de 90 minutos de respaldo.

When lighting a corridor or a traffic area, it is essential to take into account the implementation of emergency systems that provide adequate orientation, visibility and safety conditions in the event of power outages or accidents. This new emergency luminaire incorporates a robust design in self-extinguishing high-resistance materials in case of fire exposure, it has 2 ultra-bright adjustable LED heads that allow directing the lighting for maximum use. Its built-in Nickel-Cadmium battery will allow a minimum 90-minute backup operation.



APLICACIONES / APPLICATIONS



Código Sku	Potencia Power (W)	Flujo Luminoso Luminous Flux (lm)	Ángulo de Apertura Opening Angle	Temp. de Color Color Temp. (K)	IRC CRI	Vida Útil Life (h)	Dimensiones Dimensions (mm)	Color de Producto Product Color	Unidades por Caja Units per box
88687	2	200	110°	● 6500	> 70	30 000	280 x 110 x 67.5	Blanco	6



K

L

INDUSTRIAL



LEDVANCE® HIGHBAY 220 V

Luminaria compacta con estructura de aluminio y vidrio templado que garantiza alta protección IP e IK. Ideal para iluminar espacios entre 12 y 15 metros de altura. Cuenta con protección contra sobretensiones y ángulo de apertura de 105° que le brindará una excelente distribución de luz.

Compact luminaire with aluminum and tempered glass structure that guarantees high IP and IK protection. Ideal for lighting spaces between 12 and 15 meters high. It has SPD and 105° beam angle that will provide excellent light distribution.

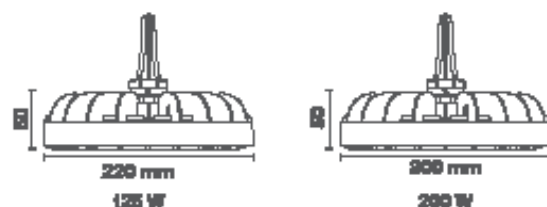

APLICACIONES / APPLICATIONS



Código Sku	Potencia Power (W)	Equivalencia Equivalence AM (W)	Flujo Luminoso Luminous Flux (lm)	Ángulo de Apertura Opening Angle	Temp. de Color Color Temp. (K)	IRC CRI	Vida Útil Life (h)	Dimensiones Dimensions (mm)	Color de Producto Product Color	Unidades por Caja Units per box
82607	125	1 x 250	15 000	105°	● 6500	>80	30 000	Ø 220 x 50	Negro Mate	1
82608	200	1 x 400	24 000	105°	● 6500	>80	30 000	Ø 300 x 50	Negro Mate	1

* En sustitución de lámparas de aditivos metálicos / In the replacement of metal halide lamps.



LEDVANCE® HIGHBAY PERFORMANCE

HIGHBAY PERFORMANCE de LEDVANCE integra un diseño moderno con estructura de aluminio fundido y difusor de policarbonato de alta resistencia siendo ahora más ligero, pero manteniendo la rigidez de antes, tiene un alto desempeño de 150 lm/W y cuenta con protección contra sobre tensiones de 4kV además de disponer de atenuación 0-10V ofreciéndole eficacia, seguridad y ahorro en un solo producto.

HIGHBAY PERFORMANCE by LEDVANCE integrates a modern design with a cast aluminum structure and a high-resistance polycarbonate diffuser being now lighter, but maintaining the rigidity of before, it has a high performance of 150 lm/W and it has surge protection of 4kV in addition to having 0-10V dimming offering efficiency, safety and savings in a single product.



- HASTA
60%
DE AHORRO
DE ENERGÍA
- 5**
AÑOS DE
GARANTÍA
- 100 – 277 V-
- IP65**
- IK08**
- 0 10
ATENUABLE
- PROTECCIÓN
CONTRA
SOBRETENSIONES
4kV

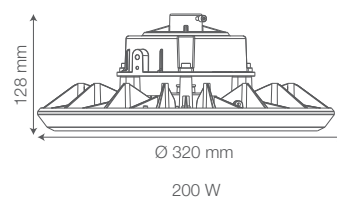
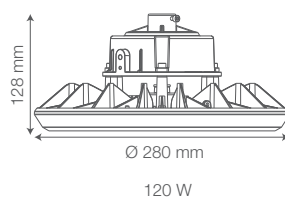

APLICACIONES / APPLICATIONS



Código Sku	Potencia Power (W)	Equivalencia Equivalence AM (W)	Flujo Luminoso Luminous Flux (lm)	Ángulo de Apertura Opening Angle	Temp. de Color Color Temp. (K)	IRC CRI	Vida Útil Life (h)	Dimensiones Dimensions (mm)	Color de Producto Product Color	Unidades por Caja Units per box
88987	120	1 x 250	18 000	110°	5700	>80	50 000	Ø 280 x 128	Negro Mate	1
88986	120	1 x 250	18 000	110°	6500	>80	50 000	Ø 280 x 128	Negro Mate	1
88989	200	1 x 400	30 000	110°	5700	>80	50 000	Ø 320 x 128	Negro Mate	1
88988	200	1 x 400	30 000	110°	6500	>80	50 000	Ø 320 x 128	Negro Mate	1
								88990	HB PFM BRACKET 120W	
								88991	HB PFM BRACKET 200W	

* Se venden por separado / They are sold separately.

* En sustitución de lámparas de aditivos metálicos / In the replacement of metal halide lamps.



Contenido relacionado con este producto en Realidad Aumentada



LEDVANCE® HIGHBAY NSF

Promueve la mejor calidad en tus procesos de producción. Cuenta con certificación NSF (National Sanitation Foundation) lo que la hace ideal para plantas de procesamiento de alimentos, garantizando seguridad e higiene. Su alto índice de protección (IP69K / IK10) eficientiza su proceso de mantenimiento ya que tiene gran resistencia a lavados de alta presión y vapores.

Promote the best quality in your production processes. It has NSF (National Sanitation Foundation) certification, which makes it ideal for food processing plants, guaranteeing safety and hygiene. Its high protection index (IP69K / IK10) makes your maintenance process more efficient, as it is highly resistant to high-pressure washing and steam.



HASTA
60%
DE AHORRO
DE ENERGÍA

NSF

100 – 277 V~

IP69K

PROTECCIÓN
CONTRA
SOBRETENSIONES
6kV

1 **10V**
ATENUABLE

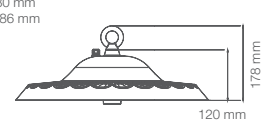
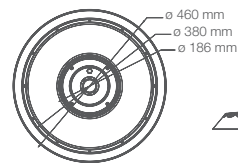

APLICACIONES / APPLICATIONS



Cocinas Industriales
Industrial Kitchens



Comisariatos
Commissariats



Procesadoras de Alimentos
Food Processors



Almacenes Fríos
Cold Warehouses

Código Sku	Potencia Power (W)	Equivalencia Equivalence AM (W)	Flujo Luminoso Luminous Flux (lm)	Ángulo de Apertura Opening Angle	Temp. de Color Color Temp. (K)	IRC CRI	Vida Útil Life (h)	Dimensiones Dimensions (mm)	Color de Producto Product Color	Unidades por Caja Units per box
89421	150	400W AM	21 000	110°	5000	>80	50 000	Ø 460 x 177	Blanco	1
89422	200	400W AM	28 000	110°	5000	>80	50 000	Ø 460 x 177	Blanco	1

* En sustitución de lámparas de aditivos metálicos / In replacement of metal halide lamps.



LEDVANCE® HIGHBAY PREMIER

Lleva la eficacia energética al siguiente nivel y benefíciate con las bondades de sus ópticas logrando una iluminación focalizada y perfectamente distribuida, generando grandes ahorros energéticos y económicos, disminuyendo los equipos instalados en la planificación de proyectos. Potencializa tus ahorros empleando sistemas de control por medio de su protocolo 0-10V mejorando su eficiencia operativa.

Takes energy efficiency to the next level and benefits from the benefits of its optics, achieving focused and perfectly distributed lighting, generating great energy and economic savings, reducing the equipment installed in project planning. Potentialize your savings using control systems through its 0-10V protocol, improving its operational efficiency.



HASTA
60%
DE AHORRO
DE ENERGÍA

5
AÑOS DE
GARANTÍA

100 - 277 V~

IP44

0 10
ATENUABLE

PROTECCIÓN
CONTRA
SOBRETENSIONES
4kV

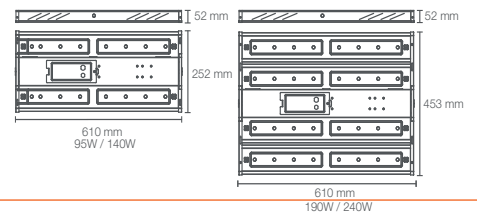

APLICACIONES / APPLICATIONS



Industrias
Industries



Hangares
Hangars



Almacenes
Warehouses



Bodegas
Wineries

Código SKU	Potencia Power (W)	Equivalencia Equivalence Fluor. T5	Flujo Luminoso Luminous Flux (lm)	Ángulo de Apertura Opening Angle	Temp. de Color Color Temp. (K)	IRC CRI	Vida Útil Life (h)	Dimensiones Dimensions (mm)	Color de Producto Product Color	Unidades por Caja Units per box	
88804	95	4 x 54W	15 200	70 x 120°	5000	>80	50 000	610 x 252 x 52	Blanco	1	
88806	140	6 x 54W	22 400	70 x 120°	5000	>80	50 000	610 x 252 x 52	Blanco	1	
88807	140	6 x 54W	22 400	70 x 120°	6500	>80	50 000	610 x 252 x 52	Blanco	1	
88808	190	NA	30 400	70 x 120°	5000	>80	50 000	610 x 453 x 52	Blanco	1	
88809	190	NA	30 400	70 x 120°	6500	>80	50 000	610 x 453 x 52	Blanco	1	
88810	190	NA	30 400	40 x 90°	5000	>80	50 000	610 x 453 x 52	Blanco	1	
88811	190	NA	30 400	40 x 90°	6500	>80	50 000	610 x 453 x 52	Blanco	1	
88812	240	NA	38 400	70 x 120°	5000	>80	50 000	610 x 453 x 52	Blanco	1	
								Accesorios* Accessories*	88853	Soportes para sobreponer	50

* Se venden por separado / They are sold separately.

* En sustitución de lámparas fluorescentes tubulares / In replacement of tubular fluorescent lamps.



LEDVANCE® CANOPY

Ilumina tus espacios del exterior con CANOPY de larga duración y bajo costo de mantenimiento, su alto flujo luminoso tiene un alcance de hasta 12 m. Su diseño ergonómico y ligero facilitan su instalación y mantenimiento. Incluye un kit de seguridad.

Illuminate your outdoor spaces with long-lasting and low-maintenance CANOPY, its high luminous flux has a range of up to 12 m. Its ergonomic and lightweight design makes it easy to install and maintain. Includes a safety kit.

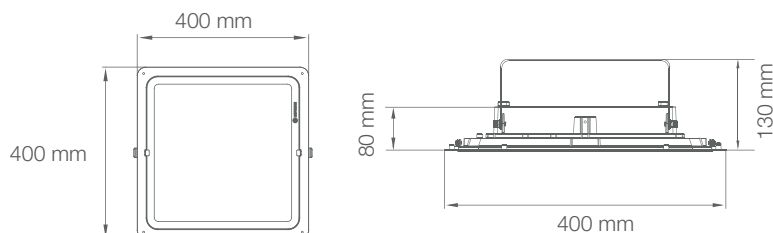

APLICACIONES / APPLICATIONS



Fachadas
Facades



Entradas principales
Main entries



Plazas comerciales
Shopping malls



Áreas recreativas
Recreative areas

Código Sku	Potencia Power (W)	Equivalencia Fluor. T5(W)	Flujo Luminoso Luminous Flux (lm)	Ángulo de Apertura Opening Angle	Temp. de Color Color Temp. (K)	IRC CRI	Vida Útil Life (h)	Dimensiones Dimensions (mm)	Color de Producto Product Color	Unidades por Caja Units per box
88998	100	4 x 54W Fluor T5	15 000	110°	5700	>80	50 000	400 x 400 x 80	Blanco	5
88999	150	6 x 54W Fluor T5	22 500	110°	5700	>80	50 000	400 x 400 x 80	Blanco	5
Accesorios* Accessories*								88194	Embedded Mounting Frame	



* En sustitución de lámparas fluorescentes tubulares / In replacement of tubular fluorescent lamps.



LEDVANCE® PLANT GROWTH

Los nuevos sistemas de iluminación LED permiten sustituir la iluminación natural mediante su espectro de reproducción de color apropiado para la fotosíntesis.

La horticultura apoyada con iluminación LED ha sido un gran aliado para los productores, permitiendo desarrollar productos alimenticios de forma más rápida, eficiente y sustentable.

LEDVANCE® PLANT GROWTH es una luminaria LED de espectro completo para crecimiento de plantas y vegetales para aplicación en interiores y exteriores.

Cuenta con chips de alta eficacia de hasta 160 lm/W con dos tonos de luz en 4000 K y 5000 K, que en conjunto con su configuración de LED rojo puro de 660 nm, brindarán a tus plantas y cultivos el espectro de luz adecuado para su crecimiento progresivo.

The new LED lighting systems make it possible to replace natural lighting through its color rendering spectrum suitable for photosynthesis.

Horticulture supported by LED lighting has been a great ally for growers, allowing them to develop food products in a faster, more efficient and sustainable way.

LEDVANCE® PLANT GROWTH is a full spectrum LED luminaire for plant and vegetable growth for indoor and outdoor application. It features high efficacy chips of up to 160 lm/W with two light tones in 4000 K and 5000 K, which together with its 660 nm pure red LED configuration, will provide your plants and crops with the right light spectrum for progressive growth.



100W



200W

4 000 K
5 000 K
660 nm

100 - 277 V~

PROTECCIÓN
CONTRA
SOBRETENSIONES
6kV

IP65

5
AÑOS DE
GARANTÍA

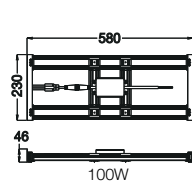

100W

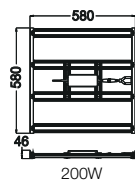

200W

APLICACIONES / APPLICATIONS



Invernaderos
Green House



Horticultura
Horticulture

Código Sku	Potencia Power (W)	Flujo Luminoso Luminous Flux (lm)	Ángulo de Apertura Opening Angle	Temp. de Color Color Temp.	IRC CRI	Vida Útil Life (h)	Dimensiones Dimensions (mm)	Color de Producto Product Color	Unidades por Caja Units per box
88980	100	16 000	115°	<input type="radio"/> 4000 <input checked="" type="radio"/> 5000 <input checked="" type="radio"/> 660nm	>80	50 000	230 x 580 x 46	Blanco	1
88981	200	32 000	115°	<input type="radio"/> 4000 <input checked="" type="radio"/> 5000 <input checked="" type="radio"/> 660nm	>80	50 000	580 x 580 x 46	Blanco	1



LEDVANCE® FLOODLIGHT MIDDLE WATTAGE PERFORMANCE

Reflector de LED de alta potencia para iluminación de exteriores.
Instalación fácil y rápida.

LED reflector for outdoor lighting.
Easy and fast installing.



- HASTA 50% DE AHORRO DE ENERGÍA**
- 5 AÑOS DE GARANTÍA**
- IP65**
- IK08**

- SOPORTE ROTATIVO 180°**
- LED SMD**

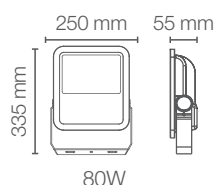

80W

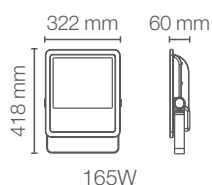

165W

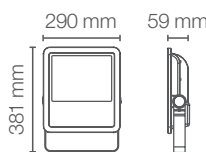

125W

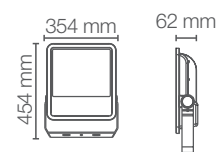

200W

APLICACIONES / APPLICATIONS

- Jardines / Gardens
- Entradas principales / Main entries
- Fachadas / Facades
- Canchas de fútbol / Soccer fields
- Áreas públicas / Public areas
- Áreas recreativas / Recreative areas
- Estacionamientos / Parking lots

Código Sku	Potencia Power (W)	Equivalencia Equivalence AM (W)	Flujo Luminoso Luminous Flux (lm)	Ángulo de Apertura Opening Angle	Tensión Tension (V~)	Temp. de Color Color Temp. (K)	IRC CRI	Vida Útil Life (h)	Dimensiones Dimensions (mm)	Color de Producto Product Color	Unidades por Caja Units per box
80650	80	1 x 175	10 000	100°	100-277	5000	>80	50 000	250 x 55 x 335	Negro	1
80652	125	1 x 250	15 000	100°	100-277	5000	>80	50 000	290 x 59 x 381	Negro	1
80654	165	1 x 400	20 000	100°	100-277	5000	>80	50 000	322 x 60 x 418	Negro	1
82023	200	1 x 400	25 000	100°	100-277	5000	>80	50 000	454 x 354 x 62	Negro	1

* En sustitución de lámparas de aditivos metálicos / In the replacement of metal halide lamps.



LEDVANCE® FLOODLIGHT HIGH POWER

FLOODLIGHT de alto rendimiento, alta reproducción de color y con protección contra sobretensiones de 6kV, adecuada para aplicaciones en espacios amplios. Disponible en versiones de 300W, 400W y 600W con 2 ángulos de apertura 30° y 60°.

FLOODLIGHT high performance, high color reproduction and 6 000 V surge protection, suitable for applications in large spaces. Available in 300W, 400W and 600W versions and two opening angles 30° and 60°.



5
AÑOS DE GARANTÍA

100 - 277 V~

PROTECCIÓN CONTRA SOBRETENSIONES
6kV

SOPORTE ROTATIVO
180°

IP65

IK08

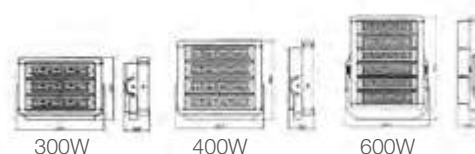

APLICACIONES / APPLICATIONS



Código Sku	Potencia Power (W)	Equivalencia Equivalence AM (W)	Flujo Luminoso Luminous Flux (lm)	Ángulo de Apertura Opening Angle	Temp. de Color Color Temp. (K)	IRC CRI	Vida Útil Life (h)	Dimensiones Dimensions (mm)	Color de Producto Product Color	Unidades por Caja Units per box
86798	300	1 x 600	36 000	30°	● 5700	>80	50 000	522 x 152 x 370	Negro	1
86799	400	1 x 750	48 000	30°	● 5700	>80	50 000	522 x 152 x 466	Negro	1
86801	600	1 x 1000	72 000	30°	● 5700	>80	50 000	575 x 152 x 700	Negro	1
86742	300	1 x 600	36 000	60°	● 5700	>80	50 000	575 x 152 x 370	Negro	1
86743	400	1 x 750	48 000	60°	● 5700	>80	50 000	522 x 152 x 466	Negro	1
86745	600	1 x 1000	72 000	60°	● 5700	>80	50 000	575 x 152 x 700	Negro	1



LEDVANCE® FLOODLIGHT HIGH POWER 1KW

Potente reflector de 1 000W con lente de policarbonato, brazo ajustable de 240° y acabado en inyección de aluminio resistente a radiación UV. Con una eficacia de 120 lm/W, tres diferentes ángulos de apertura, atenuable y alta protección contra sobretensiones. Seguridad y ahorro de energía en un solo producto.

Powerful 1,000W reflector with polycarbonate lens, 240° adjustable arm and UV-resistant aluminum injection finish. With an efficiency of 120 lm/W, three different opening angles, attenuatable and also high surge protection. Safety and energy savings in a single product.



5
AÑOS DE GARANTÍA

0 10 V
ATENUABLE

PROTECCIÓN
CONTRA
SOBRETENSIONES
10kV

SOPORTE
ROTATIVO
240°

IP66

IK08

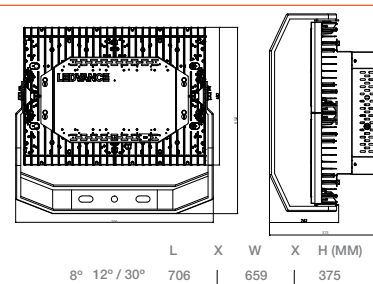

APLICACIONES / APPLICATIONS



Código Sku	Potencia Power (W)	Flujo Luminoso Luminous Flux (lm)	Ángulo de Apertura Opening Angle	Temp. de Color Color Temp. (K)	IRC CRI	Vida Útil Life (h)	Dimensiones Dimensions (mm)	Color de Producto Product Color	Unidades por Caja Units per box
85251	1 000	120 000	8°	5700	>80	50 000	706 x 659 x 375	Gris	1
85252	1 000	120 000	12°	5700	>80	50 000	706 x 659 x 375	Gris	1
85253	1 000	120 000	30°	5700	>80	50 000	706 x 659 x 375	Gris	1

*Producto bajo pedido / Make to order product.



Los accesorios de instalación como: cable DMX, conectores DMX y/o panel de control DMX no están incluidos con el producto.

LEDVANCE® FLOODLIGHT HIGH POWER 1KW DMX

Obtén todas las bondades de FLOODLIGHT HP 1KW y complementa con toda la dinámica que ofrece el protocolo de control DMX 512. Implementa conectividad y rendimiento a tus proyectos, controlando y regulando la intensidad de luz, creando escenas y programaciones especiales para espectáculos o grandes eventos.

Get all the benefits of FLOODLIGHT HP 1KW and complement all the dynamics offered by the DMX 512 control protocol. Implement connectivity and performance to your projects, controlling and regulating the intensity of light, creating scenes and special settings for shows or big events.

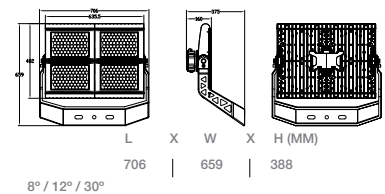

APLICACIONES / APPLICATIONS



Estadios
Stadiums

Autódromos
Racetracks

Concursos
Concerts

Espectáculos
Shows

Código Sku	Potencia Power (W)	Flujo Luminoso Luminous Flux (lm)	Ángulo de Apertura Opening Angle	Temp. de Color Color Temp. (K)	IRC CRI	Vida Útil Life (h)	Dimensiones Dimensions (mm)	Color de Producto Product Color	Unidades por Caja Units per box
85254*	1 000	120 000	8°	5700	>80	50 000	706 x 659 x 388	Gris	1
85255*	1 000	120 000	12°	5700	>80	50 000	706 x 659 x 388	Gris	1
85256*	1 000	120 000	30°	5700	>80	50 000	706 x 659 x 388	Gris	1



Accesorios*
Accessories*

85257

Connector XLR3 - RJ45 2m

*Producto bajo pedido / Make to order product.



LEDVANCE® FLOODLIGHT 1.4 KW

Incrementa la energía, estimula y fomenta la concentración de los jugadores en la cancha de juego con una adecuada iluminación.

Vive cada momento del espectáculo con FLOODLIGHT 1.4 kW. Pon en marcha tu pasión con ayuda de los controladores proporciona un versátil dinamismo que aportara una óptima visibilidad a los espectadores, regulando la intensidad de luz creando momentos inolvidables.

Increases energy, stimulates and promotes the concentration of the players on the playing field with adequate lighting.

Live every moment of the show with the FLOODLIGHT 1.4 kW. Put your passion into motion with the help of the controllers, it provides a versatile dynamism that will provide optimal visibility to the spectators, regulating the light intensity creating unforgettable moments.

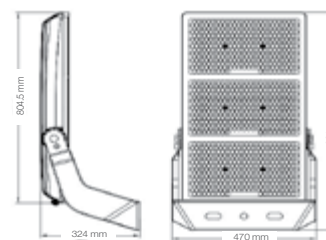

APLICACIONES / APPLICATIONS



Código Sku	Potencia Power (W)	Flujo Luminoso Luminous Flux (lm)	Ángulo de Apertura Opening Angle	Temp. de Color Color Temp. (K)	IRC CRI	Vida Útil Life (h)	Dimensiones Dimensions (mm)	Color de Producto Product Color	Unidades por Caja Units per box
89757	1 400	180 000	8°	● 5700	>80	75 000 L80	804 x 470 x 324	Gris	1
89758	1 400	180 000	12°	● 5700	>80	75 000 L80	804 x 470 x 324	Gris	1
89759	1 400	195 000	15°	● 5700	>80	75 000 L80	804 x 470 x 324	Gris	1
89760	1 400	210 000	30°	● 5700	>80	75 000 L80	804 x 470 x 324	Gris	1
Accesorios* Accessories*							89761	DRIVER 100-277V 3X540W DIM	
							89762	DRIVER 249-528V 3X540W DIM	
							89763	DRIVER 100-277V 3X540W DMX	
							89764	DRIVER 249-528V 3X540W DMX	

*Producto bajo pedido / Make to order product.



LEDVANCE® DAMP PROOF HOUSING

Luminaria diseñada para tubos LED T5 y T8 de 120 cm. Brinda protección contra el ingreso de líquidos y polvo gracias al sellado hermético que proporcionan sus clips laterales, además de un alto grado de protección contra impactos mecánicos debido a su fabricación en ABS y Policarbonato, polímeros de alta resistencia a impactos mecánicos y altas temperaturas.

Luminaire designed for T5 and T8 LED tubes in 120 cm version. Provides protection against ingress of liquids and dust thanks to the hermetic sealing provided by its side clips, in addition to a high degree of protection against mechanical impacts due to its manufacture in ABS and Polycarbonate, polymers of high resistance to mechanical impacts and high temperatures.

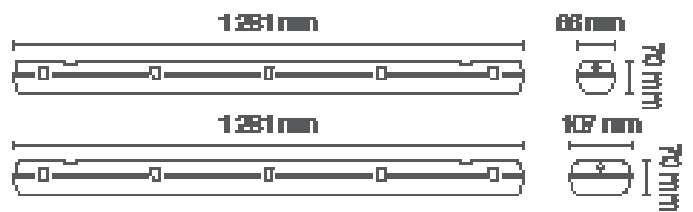

APLICACIONES / APPLICATIONS



Código Sku	Versión	Material	Potencia Max. Power (W)	Dimensiones Dimensions (mm)	Peso Weight (g)	Color de Producto Product Color	Unidades por Caja Units per box
80960	1 Lámpara	Plástico / Policarbonato	1 x 16	1261 x 66 x 70	710	Gris	8
80961	2 Lámparas	Plástico / Policarbonato	2 x 16	1261 x 107 x 70	1 092	Gris	6



LEDVANCE® DAMP PROOF SLIM

La luminaria perfecta con driver integrado de uso interior y exterior para sobreponer. Tiene diseño compacto, ligero y además es de fácil instalación.

The perfect luminaire with integrated driver for interior and exterior use to overlap. It has a compact, lightweight design and is also easy to install.



HASTA
50%
DE AHORRO
DE ENERGÍA

2

AÑOS DE
GARANTÍA

100 – 277 V~

IP65

PROTECCIÓN
CONTRA
SOBRETENSIONES
2 kV

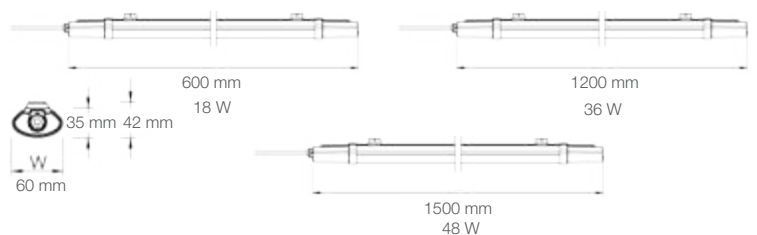

APLICACIONES / APPLICATIONS



Código Sku	Potencia Power (W)	Equivalencia Equivalence Fluor. T8 (W)	Flujo Luminoso Luminous Flux (lm)	Ángulo de Apertura Opening Angle	Temp. de Color Color Temp. (K)	IRC CRI	Vida Útil Life (h)	Dimensiones Dimensions (mm)	Color de Producto Product Color	Unidades por Caja Units per box
89476	18	2 x 14 T5 ó 2 x 17 T8	1 980	120°	● 6500	>70	20 000	600 x 60 x 35	Blanco	18
89478	36	2 X 28 T5 ó 2 x 32 T8	3 960	120°	● 6500	>70	20 000	1200 x 60 x 35	Blanco	18
89480	48	2 x 54 T5 ó 2 x 59 T8	5 280	120°	● 6500	>70	20 000	1500 x 60 x 35	Blanco	18

*En sustitución de lámparas fluorescentes tubulares. / In replacement of tubular fluorescent lamps.



LEDVANCE® DAMP PROOF LED PERFORMANCE

Nuestra línea de luminarias LED a prueba de vapor cuenta con nueva imagen y ha reforzado su grado de protección IP con clips de seguridad de acero inoxidable. Ahora encuentre su DAMP PROOF LED en 18W, 36W, 40W y 58W con mayor desempeño de 130 lm/W y mayor ángulo de apertura.

Our waterproof LED luminaires has a new look, IP protection has been reinforced with stainless steel safety clips. Now find your DAMP PROOF LED in 18W, 36W, 40W, and 58W with higher performance than 130 lm/W and greater opening angle.



HASTA
50%
DE AHORRO
DE ENERGÍA

5

AÑOS DE
GARANTÍA

100 – 277 V~

IK08

IP65

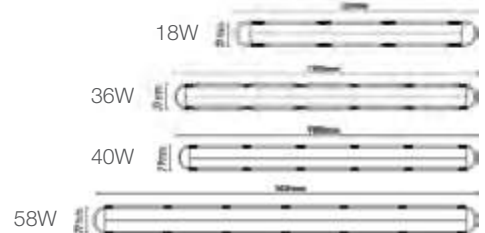

APLICACIONES / APPLICATIONS

- 

Cámaras frigoríficas
Cold rooms



Hangares
Hangars



Industrias
Industries



Estacionamientos
Parking lots



Vapores y Saunas
Steam Room

Código Sku	Potencia Power (W)	Equivalencia Fluor. T8 (W)	Flujo Luminoso Luminous Flux (lm)	Ángulo de Apertura Opening Angle	Temp. de Color Color Temp. (K)	IRC CRI	Vida Útil Life (h)	Dimensiones Dimensions (mm)	Color de Producto Product Color	Unidades por Caja Units per box
86889	18	2 x 14 T5 ó 2 x 17 T8	2 340	110°	○ 4000	>80	50 000	600 x 77 x 66	Gris	6
86890	18	2 x 14 T5 ó 2 x 17 T8	2 340	110°	● 6500	>80	50 000	600 x 77 x 66	Gris	6
86892	36	2 X 28 T5 ó 2 x 32 T8	4 680	110°	● 6500	>80	50 000	1200 x 77 x 66	Gris	6
88564	40	2 X 28 T5 ó 2 x 32 T8	4 800	115°	○ 4000	>80	30 000	1199 x 77 x 68	Gris	6
86893	58	2 x 54 T5 ó 2 x 59 T8	7 540	110°	○ 4000	>80	50 000	1500 x 77 x 66	Gris	6
86894	58	2 x 54 T5 ó 2 x 59 T8	7 540	110°	● 6500	>80	50 000	1500 x 77 x 66	Gris	6

* En sustitución de lámparas fluorescentes tubulares. / In replacement of tubular fluorescent lamps.



LEDVANCE® DAMP PROOF LED PFM SENSOR

Luminaria LED a prueba de polvo y vapor de LED para sobreponer en techo.
 Difusor de policarbonato de alta resistencia
 Incluye sensor de movimiento de tecnología microondas.
 Sensor configurable por: tiempo, sensibilidad y nivel de iluminación.
 Eficacia de hasta 120 lm/W.
 Garantía de 5 años.



HASTA
50 000h
 VIDA ÚTIL

5
 AÑOS DE
 GARANTÍA

HASTA
50%
 DE AHORRO
 DE ENERGÍA



	* / ☾			☽			☼				
	1	2	3	4	5	6	7	8			
I	ON	ON	ON	2 Lux	ON	ON	ON	5 s	ON	ON	100%
II	-	ON	ON	10 Lux	ON	ON	-	30 s	ON	-	75%
III	-	ON	-	30 Lux	ON	-	ON	90 s	-	ON	50%
IV	-	-	ON	50 Lux	ON	-	-	5 min	-	-	25%
V	-	-	-	OFF	-	ON	ON	20 min	-	-	-
VI	-	-	-	-	-	-	-	30 min	-	-	-

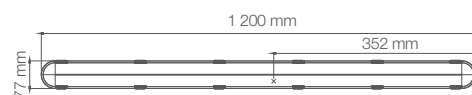

APLICACIONES / APPLICATIONS



Código Sku	Potencia Power (W)	Equivalencia Equivalence Fluor. T8(W)	Flujo Luminoso Luminous Flux (lm)	Ángulo de Apertura Opening Angle	Temp. de Color Color Temp. (K)	IRC CRI	Vida Útil Life (h)	Dimensiones Dimensions (mm)	Color de Producto Product Color	Unidades por Caja Units per box
89979	36	2 x 28 T8 ó 2 x 32 T8	5 400	120°	☉ 4000	>80	50 000 L70	1200 x 77 x 66	Gris	6
86900	36	2 x 28 T8 ó 2 x 32 T8	4 320	110°	● 6500	>80	50 000 L70	1200 x 77 x 66	Gris	6

* En sustitución de lámparas fluorescentes tubulares / In replacement of tubular fluorescent lamps.



LEDVANCE® DAMP PROOF EMERGENCY DRIVER

Nueva versión de luminaria LED a prueba de vapor con Sistema de Emergencia que permite utilizar la luminaria de manera habitual y a su vez contar con una iluminación de respaldo de hasta 180 minutos garantizando la seguridad de los usuarios cuando exista un corte en el suministro de energía.

New version of waterproof LED luminaire with Emergency System that allows the luminaire to be used regularly and at the same time have back-up lighting of up to 180 minutes warranting the safety of users when there is a cut in the power supply.



100-277 V~

IP65

3
AÑOS DE GARANTÍA

IK08

600 lm
DE ILUMINACIÓN EMERGENCIA

CARGA DE BATERÍA EN 24h



APLICACIONES / APPLICATIONS



Código Sku	Potencia Power (W)	Equivalencia Equivalence Fluor. T8(W)	Flujo Luminoso Luminous Flux (lm)	Ángulo de Apertura Opening Angle	Temp. de Color Color Temp. (K)	IRC CRI	Vida Útil Life (h)	Dimensiones Dimensions (mm)	Color de Producto Product Color	Unidades por Caja Units per box
88569	43	2 x 32Wzzzzz	4 773	115°	○ 4000	>80	30 000	1199 x 77 x 68	Gris	6
88570	43	2 x 32W	4 773	115°	● 6500	>80	30 000	1199 x 77 x 68	Gris	6
80356	60	2 x 59W	6 960	115°	○ 4000	>80	30 000	1499 x 77 x 68	Gris	6
88572	61	2 x 59W	6 956	115°	● 6500	>80	30 000	1499 x 77 x 68	Gris	6

* En sustitución de lámparas fluorescentes tubulares / In replacement of tubular fluorescent lamps.



LEDVANCE® VAPOR TIGHT PFM

VAPOR TIGHT PFM ofrece un rendimiento y durabilidad excepcional. Su eficacia de 157 lm/W te permitirá implementar iluminación brillante y uniforme mientras reduces significativamente el consumo energético. Además, está equipada con un protocolo de comunicación 0-10 V, lo que te permitirá implementar atenuadores tradicionales o sistemas de control inalámbricos para optimizar aún más tu instalación.

Esta luminaria garantiza una protección duradera y confiable gracias a sus materiales de fabricación de alta resistencia, en este caso, policarbonato, el cual nos brindará protección contra impactos mecánicos de grado IK08, además de protección NEMA4X, lo que garantiza resistencia frente a ciertos agentes corrosivos.

VAPOR TIGHT PFM offers exceptional performance and durability. Its efficiency of 157 lm/W will allow you to implement bright and uniform lighting while significantly reducing energy consumption. In addition, it is equipped with a 0-10 V communication protocol, which will allow you to implement traditional dimmers or wireless control systems to further optimize your installation.

This luminaire guarantees long-lasting and reliable protection thanks to its high-resistance manufacturing materials, in this case, polycarbonate, which will provide protection against IK08 grade mechanical impacts, as well as NEMA4X protection, which guarantees resistance against certain corrosive agents.



**NEMA
4X**

IP66

IK08

HASTA
100 000h
VIDA ÚTIL
L70

0 10
ATENUABLE

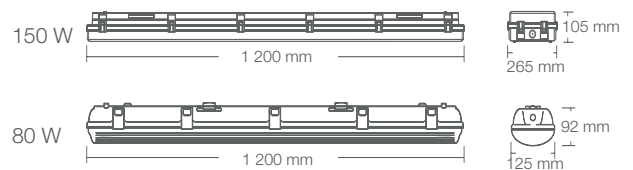

APLICACIONES / APPLICATIONS



Código Sku	Potencia Power (W)	Equivalencia Equivalence Fluor. T5(W)	Flujo Luminoso Luminous Flux (lm)	Ángulo de Apertura Opening Angle	Temp. de Color Color Temp. (K)	IRC CRI	Vida Útil Life (h)	Dimensiones Dimensions (mm)	Color de Producto Product Color	Unidades por Caja Units per box
90021	150	6 x 54W	23 550	110°	5000	>80	50 000	1200 x 265 x 105	Gris	1
90019	80	3 x 54W	12 560	110°	5000	>80	50 000	1200 x 125 x 92	Gris	1

* En sustitución de lámparas fluorescentes tubulares / In replacement of tubular fluorescent lamps.



LEDVANCE® WALL PACK

Luminaria para sobreponer en muro, con estructura de aluminio extruido resistente a impactos mecánicos de grado IK08, y para aplicaciones exteriores gracias a la hermeticidad que le brinda su IP65. Adquiera la iluminación ideal de acuerdo a sus necesidades gracias a la atenuación que le permite el controlador de la luminaria, así como también le brinda un rendimiento de hasta 130 lm/W.

Surface mounted aluminum luminaire for external application due the high resistant IP/IK. Acquire the ideal lighting according to your needs thanks to the dimming allowed by the luminaire controller, as well as giving you a performance of up to 130 lm/W.



HASTA
80%
DE AHORRO
DE ENERGÍA

5
AÑOS DE
GARANTÍA

FULL CUTOFF

PROTECCIÓN
CONTRA
SOBRETENSIONES
2kV

0 10V
ATENUABLE

120-277 V~

UL

IP 65

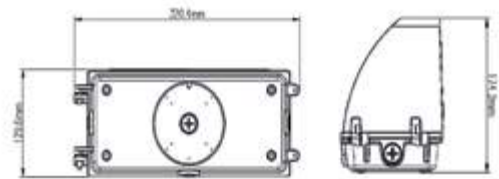

APLICACIONES / APPLICATIONS



Código SKU	Potencia Power (W)	Equivalencia Equivalence AM (W)	Flujo Luminoso Flux (lm)	Ángulo de Apertura Opening Angle	Temp. de Color Color Temp. (K)	IRC CRI	Vida Útil Life (h)	Dimensiones Dimensions (mm)	Color de Producto Product Color	Unidades por Caja Units per box
80436	70	400	9 100	110°	○ 4000	>80	50 000	320.4 x 129.6 x 174.2	Gris Oscuro	4
80437	70	400	9 100	110°	● 6500	>80	50 000	320.4 x 129.6 x 174.2	Gris Oscuro	4

* En sustitución de lámparas de aditivos metálicos / In the replacement of metal halide lamps.

EXTERIOR





LEDVANCE® SPIKE

La nueva línea de luminarias para jardín de LEDVANCE combina calidad y confianza, dos aspectos decisivos para la aplicación en exteriores. Con alta resistencia y durabilidad, la línea LEDVANCE SPIKE está especialmente diseñada para resistir en áreas externas con grado de protección IP67 e IK08.

The new line LEDVANCE SPIKE combines quality and reliability, two decisive aspects for outdoor applications. With high strength and durability, these luminaires is specially designed to resist in external areas with high index protection IP67 and IK08.



- 2**
AÑOS DE GARANTÍA
- FÁCIL INSTALACIÓN
- 100 - 240 V~**
- IP67**
- INCLUYE LLAVE HEXAGONAL

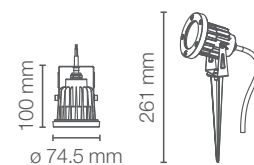

APLICACIONES / APPLICATIONS

- Ambientes residenciales
Residential environments
- Jardines
Gardens
- Entradas principales
Main entries
- Áreas recreativas
Recreative areas
- Áreas públicas
Public areas

Código Sku	Potencia Power (W)	Equivalencia Equivalence Halógena (W)	Flujo Luminoso Luminous Flux (lm)	Ángulo de Apertura Opening Angle	Temp. de Color Color Temp. (K)	IRC CRI	Vida Útil Life (h)	Dimensiones Dimensions (mm)	Color de Producto Product Color	Unidades por Caja Units per box
86635	5	45	350	24°	5000	>80	15 000	Ø 74.50 x 261	Negro	30
86642	9	65	720	30°	3000	>80	15 000	Ø 74.50 x 261	Negro	30
86643	9	65	720	30°	5000	>80	15 000	Ø 74.50 x 261	Negro	30

* En sustitución de lámparas halógenas convencionales / In the replacement of conventional halogen lamps.



LEDVANCE® UPLIGHT

Luminarias de LED integrado empotrables en piso, ideal para destacar cualquier tipo de espacio a través de su iluminación de alta eficacia y su ángulo de apertura de 20°. Su elegante diseño facilita integrarlo a la arquitectura de cualquier espacio urbano e incluso residencial, siendo un complemento perfecto para el paisajismo del lugar.

Embed floor LED luminaires, ideal for highlighting any type of space through its high efficiency lighting and 20° opening angle. Its elegant design makes it easy to integrate it into the architecture of any urban and even residential space, being a perfect complement to the landscaping of the place.



HASTA
80%
DE AHORRO
DE ENERGÍA

3
AÑOS DE
GARANTÍA

100 – 240V~

IP67

IK10

120 mm
145 mm
6 W / 9 W

160 mm
160 mm
15 W

APLICACIONES / APPLICATIONS



Código Sku	Potencia Power (W)	Equivalencia Equivalence Halógena (W)	Flujo Luminoso Luminous Flux (lm)	Ángulo de Apertura Opening Angle	Temp. de Color Color Temp. (K)	IRC CRI	Vida Útil Life (h)	Dimensiones Dimensions (mm)	Color de Producto Product Color	Unidades por Caja Units per box
80876	6	1 X 50*	480	20°	3000	>70	30 000	Ø 120 x 145	Gris	8
80877	6	1 X 50*	480	20°	5000	>70	30 000	Ø 120 x 145	Gris	8
80879	9	1 X 75*	810	20°	3000	>70	30 000	Ø 120 x 145	Gris	8
80881	9	1 X 75*	810	20°	5000	>70	30 000	Ø 120 x 145	Gris	8
80882	15	1 X 100*	1 500	20°	3000	>70	30 000	Ø 160 x 160	Gris	4
80883	15	1 X 100*	1 500	20°	5000	>70	30 000	Ø 160 x 160	Gris	4

**En sustitución de lámparas de aditivos metálicos cerámicos / In the replacement of ceramic metal halide lamps.



LEDVANCE® WALL LIGHT APLIQUE SINGLE & DUAL HOUSING

Luminarias decorativas para uso interior y exterior en versión housing.

Gracias a su base GU10 integrada se logra una combinación de APLIQUE + Lámpara PAR16 posibilitando aplicaciones con diferentes temperaturas de color (Luz Cálida, Blanco Frío, Luz de Día o hasta RGB).

Decorative luminaires for indoor and outdoor use in housing.

Thanks to its integrated GU10 base, a combination of APLIQUE + PAR16 lamp is achieved, enabling applications with different color temperatures (Warm Light, Cool Light, Day Light or even RGB light).

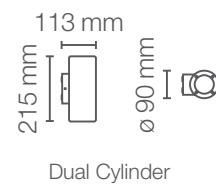
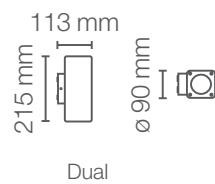

APLICACIONES / APPLICATIONS

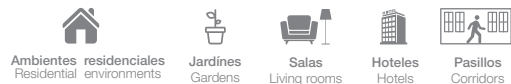

Compatible con nuestra línea de lámparas
LED SUPERSTAR PAR16.

Código Sku	Versión	Material	Potencia Max. Power (W)	Base	Dimensiones Dimensions (mm)	Peso Weight (g)	Color de Producto Product Color	Unidades por caja Units per box
86596	Dual	Policarbonato	2 x 11	GU10	90 x 113 x 215	558	Negro	16
86597	Dual	Policarbonato	2 x 11	GU10	90 x 113 x 215	558	Blanco	16
86599	Dual Cylinder	Policarbonato	2 x 11	GU10	90 x 113 x 215	498	Negro	16
86598	Dual Cylinder	Policarbonato	2 x 11	GU10	90 x 113 x 215	498	Blanco	16



LEDVANCE® WALL LIGHT DECOLED

Luminarias decorativas para uso interior y exterior en versión led integrado.

Decorative luminaires for indoor and outdoor use in integrated LED version.

3 AÑOS DE GARANTÍA
2 COLORES COLORES
100 - 240 V~
DISÑO COMPACTO
IP65

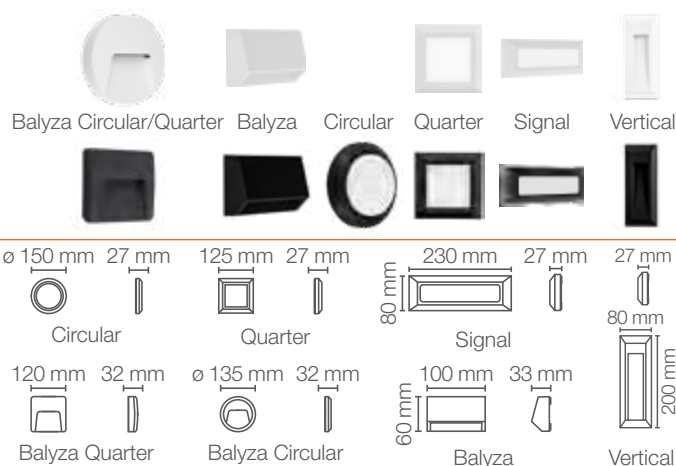

APLICACIONES / APPLICATIONS

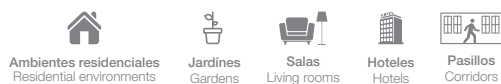

Código Sku	Versión	Potencia Power (W)	Flujo Luminoso Luminous Flux (lm)	Ángulo de Apertura Opening Angle	Temp. de Color Color Temp. (K)	IRC CRI	Vida Útil Life (h)	Dimensiones Dimensions (mm)	Color de Producto Product Color	Unidades por caja Units per box
86610	Circular	3	150	110°	3000	>80	30 000	∅ 150 x 27	Negro	24
86608	Quarter	3	150	110°	3000	>80	30 000	125 x 125 x 27	Negro	24
86609	Quarter	3	150	110°	3000	>80	30 000	125 x 125 x 27	Blanco	24
86604	Signal	4	180	110°	3000	>80	30 000	230 x 80 x 27	Negro	24
86605	Signal	4	180	110°	3000	>80	30 000	230 x 80 x 27	Blanco	24
86606	Vertical	1	30	140°	3000	>80	30 000	80 x 200 x 27	Negro	24
86607	Vertical	1	30	140°	3000	>80	30 000	80 x 200 x 27	Blanco	24
86612	Balyza	1.5	70	160°	3000	>80	30 000	100 x 60 x 33	Negro	24
86613	Balyza	1.5	70	160°	3000	>80	30 000	100 x 60 x 33	Blanco	24
86689	Balyza Quarter	3	100	112°	3000	>80	30 000	120 x 120 x 32	Negro	24
86692	Balyza Circular	3	100	104°	3000	>80	30 000	∅ 135 x 32	Blanco	24



LEDVANCE® ENDURA

Elegante línea decorativa de luminarias LED para uso interior y exterior con diseño sofisticado.

Elegant decorative line of LED luminaires for indoor and outdoor use with sophisticated design.



5
AÑOS DE GARANTÍA

FÁCIL INSTALACIÓN

100 - 277 V~

IP44

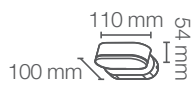

Mini Spot

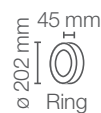

Ring



UpDown

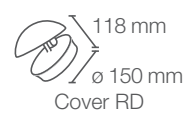

Cover RD



Shield



UpDown Puck

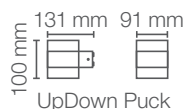

UpDown Puck

APLICACIONES / APPLICATIONS



Código Sku	Versión	Potencia Power (W)	Flujo Luminoso Luminous Flux (lm)	Ángulo de Apertura Opening Angle	Temp. de Color Color Temp. (K)	IRC CRI	Vida Útil Life (h)	Dimensiones Dimensions (mm)	Color de Producto Product Color	Unidades por caja Units per box
86866	UpDown Deco I	6	280	40°	● 3000	>80	30 000	130 x 100 x 50	Gris Oscuro	6
86867	UpDown Deco II	11	550	40°	● 3000	>80	30 000	130 x 140 x 50	Gris Oscuro	6
86868	UpDown Puck	13	980	120°	● 3000	>80	30 000	131 x 110 x 91	Gris Oscuro	6
86876	Ring	13	500	100°	● 3000	>80	30 000	∅ 202 x 45	Gris Oscuro	6
86878	Mini Spot I	8	320	100°	● 3000	>80	30 000	100 x 110 x 54	Gris Oscuro	6
86879	Mini Spot II	13	800	100°	● 3000	>80	30 000	100 x 230 x 54	Gris Oscuro	6
86880	Cover RD	13	640	100°	● 3000	>80	30 000	∅ 150 x 142	Gris Oscuro	4
86881	Cover RD	13	640	100°	● 3000	>80	30 000	∅ 150 x 142	Blanco	4
86883	Shield SQ	11	400	340°	● 3000	>80	30 000	142 x 240 x 60	Gris Oscuro	6



LEDVANCE® SOLAR

Aprovecha la energía natural del sol para iluminar tus espacios sin gastar un solo peso en consumo eléctrico al mismo tiempo que favoreces al cuidado de nuestro planeta con el uso de energías limpias.

Implementa iluminación sofisticada con un sistema fotovoltaico todo en uno, al no necesitar ningún tipo de conexión eléctrica podrás realizar la instalación TÚ mismo en cualquier espacio.

Sus materiales de alta resistencia y su hermeticidad de grado IP65 lo convierten en la opción ideal para iluminar áreas exteriores, además su eficiente batería combinada con su sensor infrarrojo (PIR) te garantizan iluminación óptima y autónoma por hasta 15 horas.

Take advantage of the natural energy of the sun to illuminate your spaces without spending money on electricity consumption while favoring the care of our planet with the use of clean energy.

Implement sophisticated lighting with an all-in-one photovoltaic system, since you do not need any type of electrical connection, you can carry out the installation YOURSELF in any space.

Its high-resistance materials and its IP65 degree of tightness make it the ideal option for lighting outdoor areas, plus its efficient battery combined with its infrared sensor (PIR) guarantee optimal and autonomous lighting for up to 15 hours.



SOLAR WALL

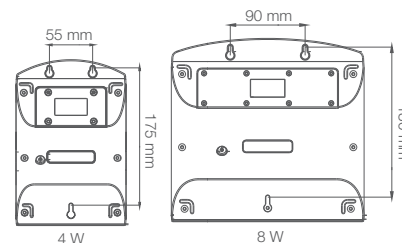

APLICACIONES / APPLICATIONS



Código Sku	Potencia Power (W)	Flujo Luminoso Luminous Flux (lm)	Ángulo de Apertura Opening Angle	Temp. de Color Color Temp. (K)	IRC CRI	Vida Útil Life (h)	Dimensiones Dimensions (mm)	Color de Producto Product Color	Unidades por Caja Units per box
89544	4	500	90°	● 6500	>80	25 000	211 x 140 x 114	Negro	8
89545	8	850	90°	● 6500	>80	25 000	232 x 220 x 121	Negro	8

LEDVANCE® SOLAR FLOODLIGHT



SOLAR FLOODLIGHT

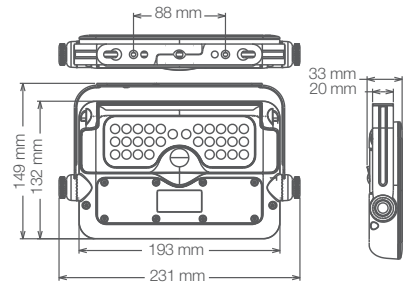

Código Sku	Potencia Power (W)	Flujo Luminoso Luminous Flux (lm)	Ángulo de Apertura Opening Angle	Temp. de Color Color Temp. (K)	IRC CRI	Vida Útil Life (h)	Dimensiones Dimensions (mm)	Color de Producto Product Color	Unidades por Caja Units per box
89546	5	500	90°	6500	>80	25 000	231 x 149 x 33	Negro	8

LEDVANCE® SOLAR SECURITY LIGHT



SOLAR SECURITY LIGHT

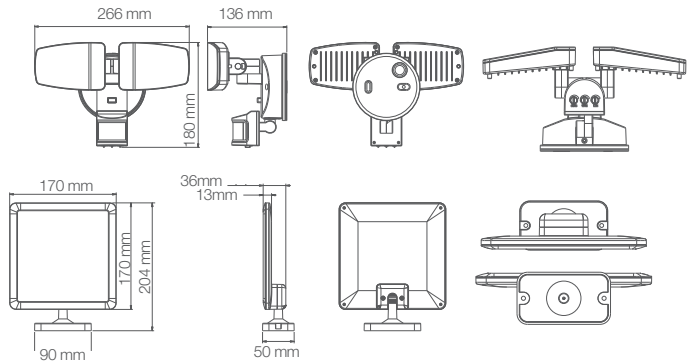

Código Sku	Potencia Power (W)	Flujo Luminoso Luminous Flux (lm)	Ángulo de Apertura Opening Angle	Temp. de Color Color Temp. (K)	IRC CRI	Vida Útil Life (h)	Dimensiones Dimensions (mm)	Color de Producto Product Color	Unidades por Caja Units per box
89547	10	1000	100°	6500	>80	25 000	265 x 181 x 136	Negro	8



LEDVANCE® FLOODLIGHT LOW WATTAGE PERFORMANCE

Reflector de LED para iluminación de exteriores, elaborado con materiales de alta calidad, resistente a chorros de agua, lluvia y polvo. Tiene un diseño compacto y moderno, difusor en vidrio templado esmerilado antirreflejante. Disponible en temperaturas de color: Luz Cálida (3000 K) y Blanco Frío (5000 K).

LED reflector for outdoor lighting, made with high quality materials, resistant to waterjets, rain and dust. It has a compact and modern design, anti-glare frosted tempered glass diffuser. Available in Warm Light temperature (3000 K) and Cool Light (5000 K) versions.



APLICACIONES / APPLICATIONS



Código Sku	Potencia Power (W)	Equivalencia Equivalence Halógena (W)	Flujo Luminoso Luminous Flux (lm)	Ángulo de Apertura Opening Angle	Temp. de Color Color Temp. (K)	IRC CRI	Vida Útil Life (h)	Dimensiones Dimensions (mm)	Color de Producto Product Color	Unidades por Caja Units per box
80633	10	1 x 100 Hal.	1100	100°	3000	>80	50 000	122 x 131 x 36	Negro	12
80634	10	1 x 100 Hal.	1200	100°	5000	>80	50 000	122 x 131 x 36	Negro	12
80641	10	1 x 100 Hal.	1100	100°	3000	>80	50 000	122 x 131 x 36	Blanco	12
80642	10	1 x 100 Hal.	1 200	100°	5000	>80	50 000	122 x 131 x 36	Blanco	12
80637	30	1 x 250 Hal.	3 300	100°	3000	>80	50 000	177 x 186 x 42	Negro	8
80638	30	1 x 250 Hal.	3 600	100°	5000	>80	50 000	177 x 186 x 42	Negro	8
80645	30	1 x 250 Hal.	3 300	100°	3000	>80	50 000	177 x 186 x 42	Blanco	8
80646	30	1 x 250 Hal.	3 600	100°	5000	>80	50 000	177 x 186 x 42	Blanco	8
80639	50	1 x 500 Hal.	5 500	100°	3000	>80	50 000	206 x 218 x 46	Negro	8
80640	50	1 x 500 Hal.	6 000	100°	5000	>80	50 000	206 x 218 x 46	Negro	8
80647	50	1 x 500 Hal.	5 500	100°	3000	>80	50 000	206 x 218 x 46	Blanco	8
80648	50	1 x 500 Hal.	6 000	100°	5000	>80	50 000	206 x 218 x 46	Blanco	8

* En sustitución de lámparas halógenas convencionales / In the replacement of conventional halogen lamps.



LEDVANCE® FLOODLIGHT SENSOR PERFORMANCE

Descubra todas las bondades que la nueva generación de FLOODLIGHT SENSOR ofrece, este compacto reflector cuenta con una alta eficacia de hasta 120 lm/W y le brinda la libertad de ajustar la configuración del sensor de acuerdo a sus necesidades, ajuste la distancia de detección de 4 a 12 m para términos de detección de movimiento, complemente su configuración con el sensor de luz, el cual permitirá encendidos y apagados automáticos cuando haya bajos o altos niveles de iluminación en el entorno y finalmente ajuste el temporizador de apagado desde 10 segundos hasta 2 minutos.

Discover all the benefits that the new generation of FLOODLIGHT SENSOR offers, this compact reflector has a high efficiency of up to 120 lm / W and gives you the freedom to adjust the sensor settings according to your needs, adjust the detection distance of 4 to 12 m for motion detection terms, complement your configuration with the light sensor, which will allow automatic on and off when there are low or high levels of lighting in the environment and finally set the off timer from 10 seconds to 2 minutes.



- SENSOR DE PRESENCIA
- SENSOR DE LUZ
- TEMPORIZADOR
- IK07**
- HASTA 80% DE AHORRO DE ENERGÍA**
- 5 AÑOS DE GARANTÍA**
- 100 - 277 V~**
- IP65**

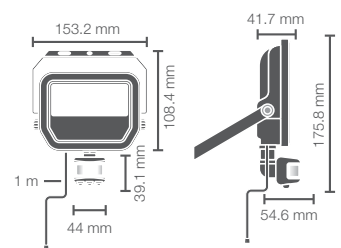
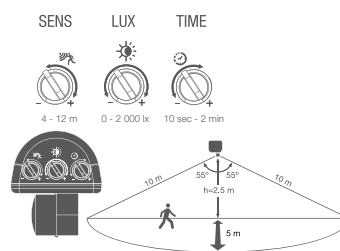

APLICACIONES / APPLICATIONS

- Jardines
Gardens
- Entradas principales
Main entries
- Fachadas
Facades
- Áreas públicas
Public areas
- Áreas recreativas
Recreative areas
- Estacionamientos
Parking lots

Código Sku	Potencia Power (W)	Equivalencia Equivalence Halógena (W)	Flujo Luminoso Luminous Flux (lm)	Ángulo de Apertura Opening Angle	Temp. de Color Color Temp. (K)	IRC CRI	Vida Útil Life (h)	Dimensiones Dimensions (mm)	Color de Producto Product Color	Unidades por Caja Units per box
80643	20	1 x 160 Hal.	2 200	100°	3000	>80	50 000	145 x 42 x 156	Negro	12
80644	20	1 x 160 Hal.	2 400	100°	5000	>80	50 000	145 x 42 x 156	Negro	12

* En sustitución de lámparas halógenas convencionales / In the replacement of conventional halogen lamps.



LEDVANCE® FLOODLIGHT RGBW

Crea dinamismo con un sistema dual que te permite elegir desde luz blanca (5000 K) hasta uno de sus 12 colores preestablecidos. Atenúa tu iluminación e implementa extrovertidos efectos a través de su control remoto y proyecta un estilo propio. Su diseño ultra-compacto lo vuelve ideal para armonizar en cualquier concepto.

Create dynamism with a dual system that lets you choose from white light (5000 K) to one of 12 preset colors. Dim your lighting and implement extrovert effects through its remote control and project your own style. Its ultra-compact design makes it ideal to harmonize with any concept.



- HASTA
80%
DE AHORRO
DE ENERGÍA
- 2**
AÑOS DE
GARANTÍA
- 100 – 240 V~
- IP65**
- CONTROL
REMOTO
INCLUIDO

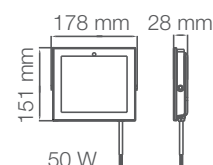

APLICACIONES / APPLICATIONS



Fachadas
Facades



Jardines
Gardens



Establecimientos
Shops



Áreas recreativas
Recreative areas

Código SKU	Potencia Power (W)	Equivalencia Equivalence Halógena (W)	Flujo Luminoso Luminous Flux (lm)	Ángulo de Apertura Opening Angle	Temp. de Color Color Temp. (K)	IRC CRI	Vida Útil Life (h)	Dimensiones Dimensions (mm)	Color de Producto Product Color	Unidades por Caja Units per box
89555	50	1 x 500 Hal.	5 000	100°	RGBW + 5000	>80	25 000	178 x 150 x 28	Negro	8



Compatible con nuestra fotocelda de tres pines 85204

LEDVANCE® URBANA

Luminaria LED para punta de poste decorativa con alta reproducción de color y alto índice de protección. Cuenta con receptáculo que permite la interconexión con sistemas de telegestión. Cubre las necesidades lumínicas con el manejo de sombras, colores y contrastes tratando la iluminación como un arte.

LED luminaire for decorative pole tip with high color reproduction and high protection index. It has a receptacle that allows interconnection with remote management systems. It covers the light needs with the handling of shadows, colors and contrasts treating lighting as an art.



incluye adaptador para fotocelda
photocell adapter included

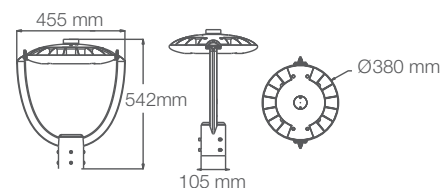

APLICACIONES / APPLICATIONS



Código Sku	Potencia Power (W)	Equivalencia Equivalence AM (W)	Flujo Luminoso Flux (lm)	Ángulo de Apertura Opening Angle	Temp. de Color Color Temp. (K)	IRC CRI	Vida Útil Life (h)	Dimensiones Dimensions (mm)	Color de Producto Product Color	Unidades por Caja Units per box
80326	75	1 x 175	9 375	115°	○ 4000	>80	50 000	Ø 455 x 522	Gris	1
80327	75	1 x 175	9 375	115°	● 5000	>80	50 000	Ø 455 x 522	Gris	1

* En sustitución de lámparas de aditivos metálicos / In the replacement of metal halide lamps.



LEDVANCE® BULKHEAD

Ilumina tus espacios del exterior con BULKHEAD que además de resultar eficiente ofrece un elegante diseño de aluminio mate que permitirá crear ambientes únicos y personalizados ofreciendo una vista confortable con una iluminación sublime.

Illuminate your outdoor spaces with BULKHEAD which, in addition to being efficient, offers an elegant matte aluminum design that will allow you to create unique and personalized environments offering a comfortable view with sublime lighting.

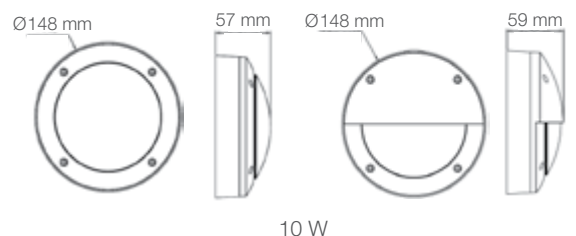
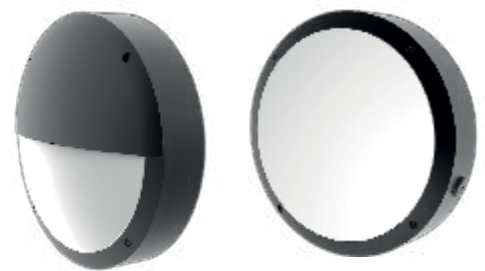

APLICACIONES / APPLICATIONS



Fachadas
Facades



Entradas principales
Main entries



Plazas comerciales
Shopping malls



Áreas recreativas
Recreative areas

Código Sku	Potencia Power (W)	Flujo Luminoso Luminous Flux (lm)	Ángulo de Apertura Opening Angle	Temp. de Color Color Temp. (K)	IRC CRI	Vida Útil Life (h)	Dimensiones Dimensions (mm)	Color de Producto Product Color	Unidades por Caja Units per box
89405	10	900	100°	3000	>80	30 000	Ø 148 x 57	Negro	8
89409	10	450	100°	3000	>80	30 000	Ø 148 x 59	Negro	8

* En sustitución de lámparas de aditivos metálicos / In the replacement of metal halide lamps.



ALUMBRADO PÚBLICO



LEDVANCE® AREALIGHT PHOTOCELL

Luminaria para alumbrado público como vialidades primarias y secundarias con alta eficiencia óptica y eficacia energética proporcionando una rápida percepción y capacidad visual. Su fotosensor integrado enciende la luminaria al detectar en el área entre 10-30 luxes y la apaga cuando detecta entre 80-120 luxes.

Luminaire for public lighting such as primary and secondary roads with high optical efficiency and energy efficiency, providing rapid perception and visual capacity. Its integrated photosensor turns on the luminaire when detecting in the area between 10-30 lux and turns it off when it detects between 80-120 lux.

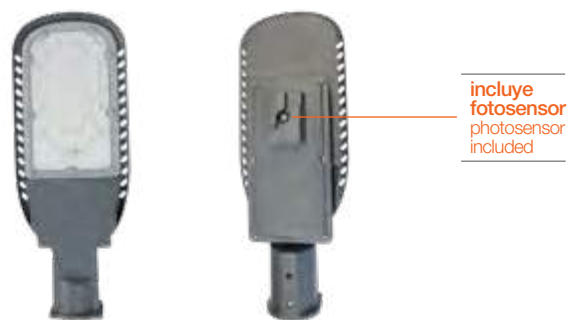

HASTA
50%
DE AHORRO
DE ENERGÍA

5
AÑOS DE
GARANTÍA

100 – 277 V~

IP66

IK08

PROTECCIÓN
CONTRA
SOBRETENSIONES
10kV

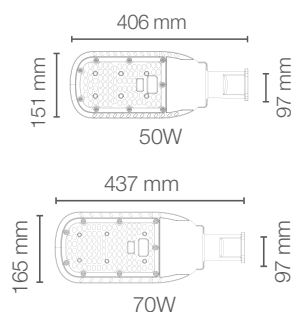

APLICACIONES / APPLICATIONS



Avenidas
Avenues



Carreteras
Roads



Áreas públicas
Public areas



Estacionamientos
Parking lots

Código Sku	Potencia Power (W)	Equivalencia Equivalence SHP (W)	Flujo Luminoso Luminous Flux (lm)	Tipo de Curva Curve Type	Temp. de Color Color Temp. (K)	IRC CRI	Vida Útil Life (h)	Dimensiones Dimensions (mm)	Color de Producto Product Color	Unidades por Caja Units per box
80338	50	1 x 100	5 000	II Media	● 6500	>80	50 000	406 x 151 x 97	Gris	6
80339	70	1 x 150	7 000	II Media	● 6500	>80	50 000	437 x 165 x 97	Gris	6
80335	50	1 x 100	5 000	II Media	○ 4000	>80	50 000	406 x 151 x 97	Gris	6
80336	70	1 x 150	7 000	II Media	○ 4000	>80	50 000	437 x 165 x 97	Gris	6

*En sustitución de lámparas de sodio de alta presión / In the replacement of sodium high pressure lamps.



Compatible con nuestra fotocelda de tres pines 85204

LEDVANCE® STREETLIGHT 10Y

Luminaria LED con receptáculo de siete pines para sustitución de equipos tradicionales de aditivos metálicos, cerámicos o vapor de sodio en alta presión logrando hasta un 70% de ahorro en el consumo de energía eléctrica.

Esta nueva generación incorpora LEDs de mayor rendimiento que garantizan un flujo luminoso de 80% a lo largo de 100 000 horas de funcionamiento, lo que se traduce en una disminución de gastos operativos y de mantenimiento.

Su novedoso diseño fabricado en aluminio inyectado en alta presión, tiene un acabado de pintura anticorrosiva que en conjunto con su alto índice de protección IP66 es recomendado para instalarse en ambientes salinos y resiste a los cambios bruscos de temperatura.

Recomendado para montaje en poste desde 6 hasta 12 metros de altura, con ajuste de inclinación de +/- 15 grados.

LED luminaire with seven-pin receptacle to replace traditional equipment with metallic, ceramic or high-pressure sodium vapor additives, achieving up to 70% savings in electrical energy consumption.

This new generation incorporates higher performance LEDs that guarantee a luminous flux of 80% over 100,000 hours of operation, which translates into lower operating and maintenance costs.

Its innovative design, made of high pressure injected aluminum, has an anticorrosive paint finish that, together with its high IP66 protection index, is recommended for installation in saline environments and resists sudden changes in temperature.

Recommended for pole mounting from 6 to 12 meters high, with tilt adjustment of +/- 15 degrees.



incluye adaptador para fotocelda
 photocell adapter included

- HASTA 60% DE AHORRO DE ENERGÍA**
- 10 AÑOS DE GARANTÍA**
- 100 - 277 V~**
- 1 10V ATENUABLE**
- PROTECCIÓN CONTRA SOBRETENSIONES 10kV**
- CURVA II MEDIA**

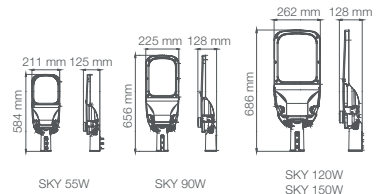

APLICACIONES / APPLICATIONS



Avenidas
Avenues



Carreteras
Highways



Áreas públicas
Public areas

Código Sku	Potencia Power (W)	Equivalencia Equivalence AM (W)	Flujo Luminoso Luminous Flux (lm)	Ángulo de Apertura Opening Angle	Temp. de Color Color Temp. (K)	IRC CRI	Vida Útil Life (h)	Dimensiones Dimensions (mm)	Color de Producto Product Color	Unidades por Caja Units per box
88790	55	100	8 250	155 x 100°	5000	>70	100 000	584 x 211 x 125.6	Gris	1
88791	90	150	13 500	155 x 100°	5000	>70	100 000	656 x 225 x 128	Gris	1
88792	120	200	18 000	155 x 100°	5000	>70	100 000	686 x 262 x 128	Gris	1

* En sustitución de lámparas de aditivos metálicos / In the replacement of metal halide lamps.



LEDVANCE® SOLAR STREETLIGHT

Luminaria LED que funciona a base de energía solar fotovoltaica, la cual es almacenada en un sistema de baterías para proveer energía limpia para sistemas de alumbrado durante la noche.
Dentro de sus principales beneficios encontramos:

TODO EN UNO: panel solar + sistema de baterías + controlador inteligente.

Módulos ajustables de inclinación de +/- 15 grados.

Cero consumo de energía eléctrica.

Autonomía de 3 días con cielo nublado.

Bajo costo de instalación y mantenimiento ya que no requiere cableado ni otra clase de dispositivos para poder operar.

Limita el impacto medioambiental aumentando la eficiencia, usando tecnología renovable.

LED luminaire that works based on photovoltaic solar energy, which is stored in a battery system to provide clean energy for lighting systems at night.

Among its main benefits we find:

ALL IN ONE: solar panel + battery system + smart controller.

Adjustable tilt modules of +/- 15 degrees.

Zero electricity consumption.

Autonomy of 3 days with cloudy sky.

Low installation and maintenance cost since it does not require wiring or other kinds of devices to be able to operate.

Limits the environmental impact by increasing efficiency, using renewable technology.

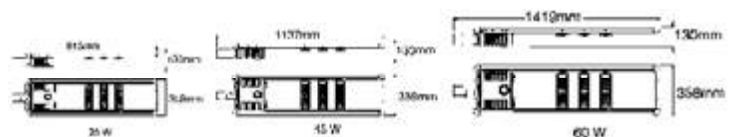

APLICACIONES / APPLICATIONS



Avenidas
Avenues



Carreteras
Highways



Áreas públicas
Public areas

Código Sku	Potencia Power (W)	Equivalencia Equivalence AM (W)	Flujo Luminoso Luminous Flux (lm)	Ángulo de Apertura Opening Angle	Temp. de Color Color Temp. (K)	IRC CRI	Vida Útil Life (h)	Dimensiones Dimensions (mm)	Color de Producto Product Color	Unidades por Caja Units per box
88770	25	50	4 625	150 x 100°	● 5000	>70	60 000	813 x 358 x 130	Negro	1
88771	45	100	8 325	150 x 100°	● 5000	>70	60 000	1137 x 358 x 130	Negro	1
88772	60	120	11 100	150 x 100°	● 5000	>70	60 000	1419 x 358 x 130	Negro	1

ÍNDICE

LÁMPARAS DE LED OSRAM

CLASSIC

LED CLASSIC A19 SUPERSTAR®	86
LED CLASSIC A19 VALUE®	87
LED A19 ATENUABLE SUPERSTAR®	88
LED P45 SUPERSTAR®	89
LED VELAS SUPERSTAR®	90
LED VELAS SUPERSTAR® DIM	91
LED GLOBO SUPERSTAR®	92
LED A19 SENSOR SUPERSTAR®	93
LED CEILING LAMP	94
LED REPELLENT DUAL	95
LED EMERGENCY	96
LED SMART+ WIFI	97
LED CONTROL REMOTO RGBW	99
LED VINTAGE 1906	100
LED FILAMENT CLASSIC	101
LED FILAMENT SPECIAL	102
LED HIGH WATTAGE SUPERSTAR®	103
LED HIGH WATTAGE ECO	104
LED HIGH WATTAGE E40 SUPERSTAR®	105
LED UFO E40 SUPERSTAR®	106
LED PIN BASE SUPERSTAR®	107



SPOT

LED AR111 SUPERSTAR®	109
LED SUPERIOR AR111 IRC90	110
LED MR16 VALUE®	111
LED PAR16 SUPERSTAR®	112
LED PAR16 SUPERSTAR IRC90	113
LED PAR16 RGBW	114
LED PAR16 VALUE	115
LED PAR20 SUPERSTAR®	116
LED PAR20 VALUE	117
LED PAR30 SUPERSTAR®	118
LED PAR30 SUPERSTAR® IP65	119
LED PAR30 HCI SUPERSTAR®	120
LED PAR30 VALUE	121
LED PAR38 SUPERSTAR® IP65	122
LED PAR38 VALUE	123



TUBOS LED

LED T8 SUPERIOR	126
LED T8 SUPERSTAR®	127
LED T8 SUPERSTAR® SENSOR	128
LED T8 VALUE G3	129
LED T8 ECO	130
LED T8 CURVALUM SUPERSTAR®	131
LED T8 SLIM SUPERSTAR®	132
LED T5 SUPERSTAR®	133





CLASSIC



LED CLASSIC A19 SUPERSTAR®

Familia de lámparas de LED ideales para iluminación general, disponibles en dos temperaturas de color: Luz Cálida (3000 K) y Luz Fría (6500 K).
Cuentan con una vida útil de 25 000 horas de vida y multivoltaje (100-240 V~).

LED CLASSIC A19 SUPERSTAR products are suitable for general lighting. Available in two different color temperatures, Warm Light (3000 K) and Cold Light (6500 K) possessing up to 25,000 hours life and high voltage range (100-240 V~).



4.5W • 8W

9.5W • 13.5W

HASTA
85%
DE AHORRO
DE ENERGÍA

3
AÑOS DE
GARANTÍA

HASTA
25 000h
VIDA ÚTIL

100 – 240 V~

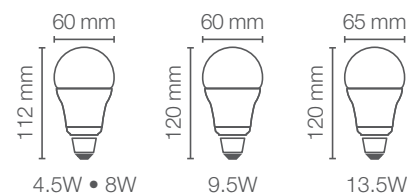

4.5W • 8W

9.5W

13.5W

APLICACIONES / APPLICATIONS



Código Sku	Potencia Power (W)	Equivalencia Inc. (W)	Flujo Luminoso Luminous Flux (lm)	IRC CRI	Temp. Color Color Temp. (K)	Vida Útil Life (h)	Acabado Product Finishing	Base Base	Atenuable Dimmable	Dimensiones Dimensions (mm)	Unidades por Caja Units per box
85965	4.5	40	480	>80	3000	25 000	Opalino	E27	No	Ø 60 x 112	12
85966	4.5	40	480	>80	6500	25 000	Opalino	E27	No	Ø 60 x 112	12
85968	8	60	800	>80	6500	25 000	Opalino	E27	No	Ø 60 x 112	12

* En sustitución de lámparas incandescentes / Replacing incandescent lamps.



LED CLASSIC A19 VALUE®

Familia de lámparas de LED ideales para iluminación general, disponibles en dos temperaturas de color: Luz Cálida (3000 K) y Luz Fría (6500 K).
Cuentan con una vida útil de 10 000 horas y voltaje dedicado (120V~).

LED CLASSIC A19 Value products are suitable for general lighting. Available in two different color temperatures, Warm Light (3000 K) and Cold Light (6500 K) possessing up to 10,000 hours life and 120V~ voltage range.



HASTA
85%
DE AHORRO
DE ENERGÍA

3
AÑOS DE
GARANTÍA

HASTA
10 000h
VIDA ÚTIL

120 V~



APLICACIONES / APPLICATIONS



Pasillos
Corridors



Recámaras
Rooms



Salas
Living rooms



Ambientes residenciales
Residential environments



Oficinas
Offices



Cuartos de Lavado
Laundry rooms

Código Sku	Potencia Power (W)	Equivalencia Equivalence Inc. (W)	Flujo Luminoso Luminous Flux (lm)	IRC CRI	Temp. Color Color Temp. (K)	Vida Útil Life (h)	Base Base	Protección Protection	Unidades por Caja Units per box
88726	5.5	120	420	80	● 2700	10 000	E27	IP20	12
88727	5.5	120	450	80	● 3000	10 000	E27	IP20	12
88728	5	120	450	80	○ 4000	10 000	E27	IP20	12
88729	5	120	450	80	● 6500	10 000	E27	IP20	12
88730	8.5	120	720	80	● 2700	10 000	E27	IP20	12
88731	8.5	120	800	80	● 3000	10 000	E27	IP20	12
88732	8.5	120	800	80	○ 4000	10 000	E27	IP20	12
88733	8.5	120	800	80	● 6500	10 000	E27	IP20	12
88734	11	120	1000	80	● 3000	10 000	E27	IP20	12
88756	11	120	1000	80	● 3000	10 000	E27	IP20	12
88757	11	120	1000	80	● 6500	10 000	E27	IP20	12
88737	13	120	1500	80	● 3000	10 000	E27	IP20	12
88738	13	120	1500	80	● 3000	10 000	E27	IP20	12
88739	13	120	1500	80	● 6500	10 000	E27	IP20	12

* En sustitución de lámparas incandescentes / Replacing incandescent lamps.



LED A19 ATENUABLE SUPERSTAR®

La versión atenuable que permite el control de la intensidad de la luz, creando una atmósfera más acogedora en salas y dormitorios.
 Uso interior donde se requiera controlar la intensidad de iluminación mediante un dimmer.





The dimmable version is perfect to control the light intensity by a dimmer creating comfort in any room of your spaces. Available in Warm Light (3000 K).

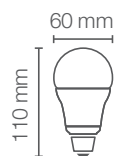

- HASTA
86%
DE AHORRO
DE ENERGÍA
- 3**
AÑOS DE
GARANTÍA
- HASTA
25 000h
VIDA ÚTIL
- 127 V~**
- 
ATENUABLE



APLICACIONES / APPLICATIONS

- 
Ambientes residenciales
Residential environments
- 
Recámaras
Rooms
- 
Hoteles
Hotels
- 
Pasillos
Corridors
- 
Establecimientos
Shops

Código Sku	Potencia Power (W)	Equivalencia Inc. (W)	Flujo Luminoso Luminous Flux (lm)	IRC CRI	Temp. Color Color Temp. (K)	Vida Útil Life (h)	Acabado Product Finishing	Base Base	Atenuable Dimmable	Dimensiones Dimensions (mm)	Unidades por Caja Units per box
88131	8.5	60	806	>80	● 3000	25 000	Opalino	E27	Si	60 x 110	12

* En sustitución de lámparas incandescentes / Replacing incandescent lamps.



LED P45 SUPERSTAR®

La familia de lámparas P45 son ideales para aplicaciones residenciales que generan un confort de tranquilidad, ideales para lámparas de mesa y luminarias decorativas. Disponibles en 3W con base E12, E14 y E27.

LED P45 SUPERSTAR are perfect for residential application at living room's lamps, giving an unique relaxed comfort. Available in E12, E14 and E27 base.



E12

E27

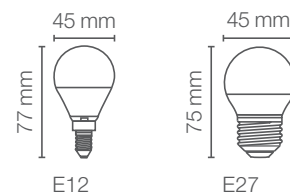

E12

E27

APLICACIONES / APPLICATIONS



Código Sku	Potencia Power (W)	Equivalencia Inc. (W)	Flujo Luminoso Luminous Flux (lm)	IRC CRI	Temp. Color Color Temp. (K)	Vida Útil Life (h)	Acabado Product Finishing	Base Base	Atenuable Dimmable	Dimensiones Dimensions (mm)	Unidades por Caja Units per box
85962	3	25 W	260	>80	6500	15 000	Opalino	E12	No	45 x 77	12
85975	3	25 W	260	>80	2700	15 000	Opalino	E27	No	45 x 75	12
85976	3	25 W	260	>80	6500	15 000	Opalino	E27	No	45 x 75	12

* En sustitución de lámparas incandescentes / Replacing incandescent lamps.



LED VELAS SUPERSTAR®

Las lámparas decorativas tipo vela ofrecen un ahorro de energía comparado con tecnologías tradicionales en versiones no atenuables con base E12 y E27.

The Candles Decorative Types offers energy savings compared with traditional technologies with NO DIM versions with E12 and E27 bases available.



3W E12
Opalino

3W E27
Opalino

3W E27
Clear

- HASTA
90%
DE AHORRO
DE ENERGÍA
- 3**
AÑOS DE
GARANTÍA
- HASTA
15 000h
VIDA ÚTIL
- 100 – 240 V~

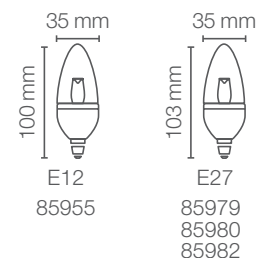

APLICACIONES / APPLICATIONS

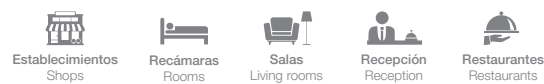

Código Sku	Potencia Power (W)	Equivalencia Equivalence Inc. (W)	Flujo Luminoso Luminous Flux (lm)	IRC CRI	Temp. Color Color Temp. (K)	Vida Útil Life (h)	Acabado Product Finishing	Base Base	Atenuable Dimmable	Dimensiones Dimensions (mm)	Unidades por Caja Units per box
85955	3	25 W	260	>80	● 2700	15 000	Opalino	E12	No	35 x 100	12
85979	3	25 W	260	>80	● 2700	15 000	Opalino	E27	No	35 x 103	12
85980	3	25 W	260	>80	● 6500	15 000	Opalino	E27	No	35 x 103	12
85982	3	25 W	260	>80	● 2700	15 000	Clear	E27	No	35 x 103	12

* En sustitución de lámparas incandescentes / Replacing incandescent lamps.



LED VELAS SUPERSTAR® DIM

Las lámparas decorativas tipo vela ofrecen un ahorro de energía comparado con tecnologías tradicionales en versiones atenuables con base E14 y E27.

The Candles Decorative Types offers energy savings compared with traditional technologies with DIM versions with E14 and E27 bases available.



4W E14

4W E27

- HASTA
90%
DE AHORRO
DE ENERGÍA**
- 3
AÑOS DE
GARANTÍA**
- HASTA
15 000h
VIDA ÚTIL**
- 127 V~**
- ATENUABLE**

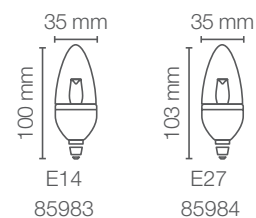

E14

E27

85983

85984

APLICACIONES / APPLICATIONS

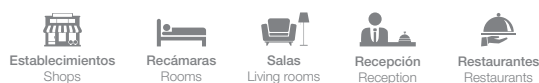

Código Sku	Potencia Power (W)	Equivalencia Equivalence Inc. (W)	Flujo Luminoso Luminous Flux (lm)	IRC CRI	Temp. Color Color Temp. (K)	Vida Útil Life (h)	Acabado Product Finishing	Base Base	Atenuable Dimmable	Dimensiones Dimensions (mm)	Unidades por Caja Units per box
85983	4	25 W	350	>80	● 2700	15 000	Clear	E14	Si	35 x 100	12
85984	4	25 W	350	>80	● 2700	15 000	Clear	E27	Si	35 x 103	12

* En sustitución de lámparas incandescentes / Replacing incandescent lamps.



LED GLOBO SUPERSTAR®

Ideal para uso residencial y hotelería. Disponible en temperatura de color: Luz Cálida (2700 K) y Luz Fría (6500 K).

LED GLOBE SUPERSTAR are perfect for hospitality and residential applications. Available in Warm Light (2700 K) and Cold Light (6500 K).

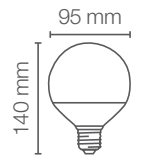

APLICACIONES / APPLICATIONS



Código Sku	Potencia Power (W)	Equivalencia Equivalence Inc. (W)	Flujo Luminoso Luminous Flux (lm)	IRC CRI	Temp. Color Color Temp. (K)	Vida Útil Life (h)	Acabado Product Finishing	Base Base	Atenuable Dimmable	Dimensiones Dimensions (mm)	Unidades por Caja Units per box
86286	9	60	900	>80	2700	15 000	Opalino	E27	No	95 x 140	12
86287	9	60	900	>80	6500	15 000	Opalino	E27	No	95 x 140	12

* En sustitución de lámparas fluorescentes / Replacing fluorescent lamps.



LED A19 SENSOR SUPERSTAR®

LED A19 SENSOR SUPERSTAR es ideal para iluminar tus espacios sin necesidad de encender la luz cada vez que lo necesites, basta con dejar el interruptor encendido. La función de la lámpara es la detección de movimiento a un rango de 3 metros, es capaz de detectar si es de día o de noche para minimizar el consumo eléctrico de la lámpara. Incluye sensor infrarrojo integrado.

LED A19 SENSOR SUPERSTAR is perfect to light up your spaces without using the switch everytime you need it, just one switch on and the motion sensor will be working to light on/off if it detects some movements from a special range of distance. Available in Warm Light (3000 K) and Day Light (6500 K).



HASTA
85%
DE AHORRO
DE ENERGÍA

2
AÑOS DE
GARANTÍA

HASTA
25 000h
VIDA ÚTIL

100 – 240 V~

E27

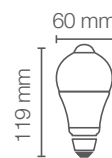
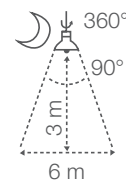

APLICACIONES / APPLICATIONS

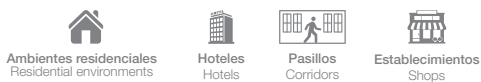

Código Sku	Potencia Power (W)	Equivalencia Equivalence Inc. (W)	Flujo Luminoso Luminous Flux (lm)	IRC CRI	Temp. Color Color Temp. (K)	Vida Útil Life (h)	Acabado Product Finishing	Base Base	Atenuable Dimmable	Dimensiones Dimensions (mm)	Unidades por Caja Units per box
88152	9	60	806	>80	3000	25 000	Opalino	E27	No	60 x 119	12
88153	9	60	806	>80	6500	25 000	Opalino	E27	No	60 x 119	12

* En sustitución de lámparas incandescentes / Replacing incandescent lamps.



LED CEILING LAMP®

La familia de productos LED CEILING LAMP es ideal para aplicaciones residenciales con un diseño original y estético con un tamaño perfecto para cualquier hogar.

Disponible en temperatura:

Luz Cálida (3000 K), Luz Neutra (4000 K) y Luz Fría (6500 K) con base E27.

LED CEILING LAMP products are perfect to use in residential applications with an unique and esthetic design and a perfect size to place anywhere. Available in Warm Light (3000 K), Neutral Light (4000 K) and Cold Light (6500 K) with E27 base.

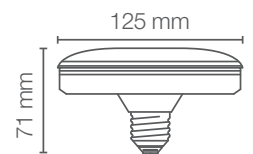

APLICACIONES / APPLICATIONS



Código Sku	Potencia Power (W)	Equivalencia Equivalence Inc. (W)	Flujo Luminoso Luminous Flux (lm)	IRC CRI	Temp. Color Color Temp. (K)	Vida Útil Life (h)	Acabado Product Finishing	Base Base	Atenuable Dimmable	Dimensiones Dimensions (mm)	Unidades por Caja Units per box
88173	14.5	100	1 300	>80	● 3000	15 000	Opalino	E27	No	125 x 71	12
88175	14.5	100	1 400	>80	○ 4000	15 000	Opalino	E27	No	125 x 71	12
88176	14.5	100	1 400	>80	● 6500	15 000	Opalino	E27	No	125 x 71	12

* En sustitución de lámparas incandescentes / Replacing incandescent lamps.

OSRAM



LED REPELLENT DUAL®

Una misma lámpara, dos beneficios. Iluminación general Luz Fría (6500 K) y amarillo (Repelente). Cambia de función con cada encendido y apagado. Ideal para zonas húmedas y mucha vegetación.



One lamp, two functions: General lighting at Cold Light (6500 K) and repellent mode. Changes the function just with one switch, best option for humidity zones.

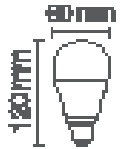

- HASTA
87%
DE AHORRO
DE ENERGÍA
- 3**
AÑOS DE
GARANTÍA
- HASTA
25 000h
VIDA ÚTIL
- 100 – 240 V~
- 
REPELENTE



APLICACIONES / APPLICATIONS

- 
Ambientes residenciales
Residential environments
- 
Hoteles
Hotels
- 
Establecimientos
Shops
- 
Jardines
Gardens
- 
Pasillos
Corridors

Uso exterior solo con luminarios.

Código Sku	Potencia Power (W)	Equivalencia Equivalence Inc. (W)	Flujo Luminoso Luminous Flux (lm)	IRC CRI	Temp. Color Color Temp. (K)	Vida Útil Life (h)	Acabado Product Finishing	Base Base	Atenuable Dimmable	Dimensiones Dimensions (mm)	Unidades por Caja Units per box
88067	8	60	806	>80	● 6500 + ● Luz amarilla (Repelente)	25 000	Opalino	E27	No	60 x 120	12

* En sustitución de lámparas incandescentes / Replacing incandescent lamps.



LED EMERGENCY

La lámpara de emergencia asegura la iluminación en todo momento, ya que funciona como un bulbo normal y gracias a su batería integrada, cambiara a modo emergencia de forma automática cuando haya una interrupción en la energía eléctrica (hasta 2.5 hrs)

The lamp has two working modes, it works as a common light bulb and it swith to emergency mode after power shut down automatically (2.5 hrs)



- HASTA
87%
DE AHORRO
DE ENERGÍA
- 2**
AÑOS DE
GARANTÍA
- HASTA
15 000h
VIDA ÚTIL
- 100 - 240 V ~
- Batería de
litio
integrada

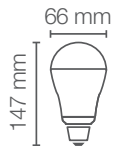

APLICACIONES / APPLICATIONS

- Ambientes residenciales
Residential environments
- Recámaras
Rooms
- Hoteles
Hotels
- Pasillos
Corridors
- Establecimientos
Shops

Código Sku	Potencia Power (W)	Equivalencia Equivalence Inc. (W)	Flujo Luminoso Luminous Flux (lm)	IRC CRI	Temp. Color Color Temp. (K)	Vida Útil Life (h)	Acabado Product Finishing	Base Base	Atenuable Dimmable	Dimensiones Dimensions (mm)	Unidades por Caja Units per box
80107	10	60	806	>80	● 3000	15 000	Opalino	E27	No	66 x 147	12
80108	10	60	850	>80	● 6500	15 000	Opalino	E27	No	66 x 147	12



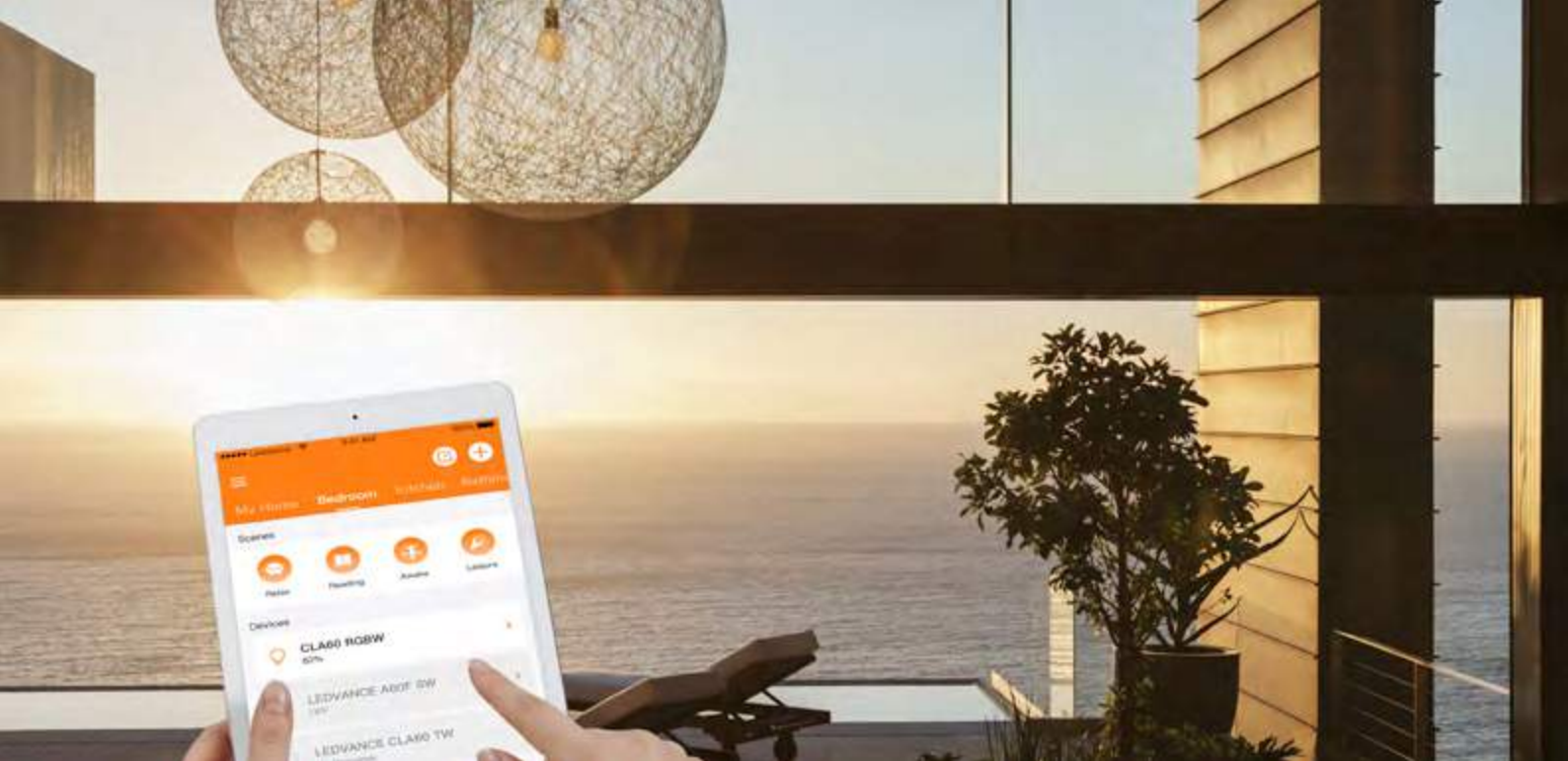

LED SMART+ WIFI®

Conexión vía WiFi (Disponible para Android y iOS). Cuenta con dos tipos de iluminación: Blanco Dinámico (2700 K a 6500 K) o Iluminación decorativa (RGB). Controla el color, intensidad, escenas e incluso el ritmo de la luz desde la aplicación Ledvance Smart+ WiFi en tu celular, o a través de comandos de voz (Alexa y Google Home).

Connected by WiFi (Available for Android and iOS). It has two types of lighting: Dynamic White (2700 K to 6500 K) or Decorative Lighting (RGB). Control the color, intensity, scenes and even the rhythm of the light from the Ledvance Smart + WiFi application on your cell phone, or through voice commands (Alexa and Google Home).

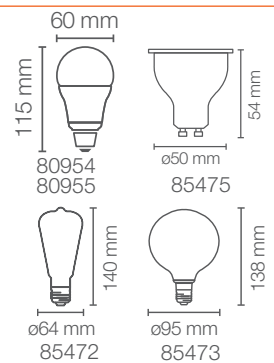

APLICACIONES / APPLICATIONS



Código Sku	Potencia Power (W)	Equivalencia Inc. (W)	Flujo Luminoso Luminous Flux (lm)	IRC CRI	Temp. Color Color Temp. (K)	Vida Útil Life (h)	Acabado Product Finishing	Base Base	Atenuable Dimmable	Dimensiones Dimensions (mm)	Unidades por Caja Units per box
80954	9	60	800	>80	RGBW	15 000	Opalino	E27	Si	60 x 115	4
80955	9	60	800	>80	2700	15 000	Opalino	E27	Si	60 x 115	4
85472	6	40	500	>80	RGB + 2700	15 000	Claro	E27	Si	64 x 140	4
85473	6	40	500	>80	RGB + 2700	15 000	Claro	E27	Si	95 x 138	4
85475	5	40	450	>80	RGBW	15 000	Claro	GU10	Si	50 x 54	12

* En sustitución de lámparas incandescentes / Replacing incandescent lamps.



LED CONTROL REMOTO RGBW®

La familia LED RGBW es un sistema de iluminación controlado vía control remoto que cuenta con control de intensidad y cambio de colores, personaliza tus ambientes con un estilo único con control de atenuación.

LED RGBW REMOTE CONTROL products are a special illumination system controlled by infrared remote control with dimmable controls and change of some colors to personalize your spaces with an unique style with dimming control.



7.5W



APLICACIONES / APPLICATIONS



Código Sku	Potencia Power (W)	Equivalencia Equivalence Inc. (W)	Flujo Luminoso Luminous Flux (lm)	IRC CRI	Temp. Color Color Temp. (K)	Vida Útil Life (h)	Acabado Product Finishing	Base Base	Atenuable Dimmable	Dimensiones Dimensions (mm)	Unidades por Caja Units per box
86277	7.5	60	600	>80	RGBW	15 000	Opalino	E27	Si	112 x 60 x 60	12 caja
86281	7.5	60	600	>80	RGBW	15 000	Opalino	E27	Si	112 x 60 x 60	6 blister

* En sustitución de lámparas incandescentes / Replacing incandescent lamps.

** Atenuable únicamente mediante control remoto (incluido) / Dimmable only by remote control (included).



LED VINTAGE® 1906

Lámparas de estilo vintage para decorar tus espacios con estilos inigualables y con un ahorro de energía de hasta 90% comparado con tecnologías tradicionales, disponibles con base E27 y E26 con acabado ambar en temperatura Luz Cálida (2500 K).

LED VINTAGE 1906 are perfect to decorate your lighting spaces with incomparable styles, saving energy up to 90% vs. traditional technologies. Available in E27 and E26 base with ambar finish in Warm Light (2500 K).

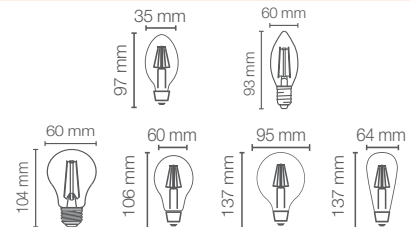

APLICACIONES / APPLICATIONS



Código Sku	Potencia Power (W)	Equivalencia Equivalence Inc. (W)	Flujo Luminoso Luminous Flux (lm)	IRC CRI	Temp. Color Color Temp. (K)	Vida Útil Life (h)	Base Base	Protección Protection	Unidades por Caja Units per box
85942	4.5	40	360	>80	● 2500	15 000	E26	IP20	6
88602	2	127 - 220	210	80	● 2 500	15 000	E19	IP20	12
88603	2.5	127 - 220	220	80	● 2 500	15 000	E27	IP20	12
88604	5.5	127 - 220	550	80	● 2 500	15 000	E27	IP20	12
88605	2.5	127 - 220	220	80	● 2 500	15 000	E27	IP20	6
88606	4.5	127 - 220	420	80	● 2 500	15 000	E27	IP20	12
88607	7	127	725	80	● 2 500	15 000	E27	IP20	12
88976	4.5	120	420	80	● 2 500	15 000	E27	IP20	12
88977	3.5	127	300	80	● 2 500	15 000	E12	IP20	12
88978	4.5	120	420	80	● 2 500	15 000	E27	IP20	12
88979	4.5	127	420	80	● 2 500	15 000	E27	IP20	12
88608	2.5	127	225	80	● 2 500	15 000	E27	IP20	12
88609	2.5	127	420	80	● 2 500	15 000	E27	IP20	12

* En sustitución de lámparas incandescentes / Replacing incandescent lamps.



LED FILAMENT CLASSIC

La familia de lámparas LED FILAMENT son ideales para aplicaciones decorativas, donde se quiera dar un toque único en los espacios, creando ambientes de confort y tranquilidad.

The family of LED FILAMENT lamps are ideal for decorative applications, where you want to give a unique touch in the spaces, creating environments of comfort and tranquility



HASTA
90%
DE AHORRO
DE ENERGÍA

3
AÑOS DE
GARANTÍA

HASTA
25 000h
VIDA ÚTIL

100-240 V~

LED
FILAMENTO

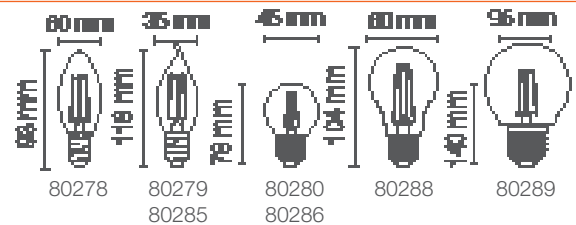

APLICACIONES / APPLICATIONS



Código Sku	Potencia Power (W)	Equivalencia Inc. (W)	Flujo Luminoso Luminous Flux (lm)	IRC CRI	Temp. Color Color Temp. (K)	Vida Útil Life (h)	Base Base	Protección Protection	Unidades por Caja Units per box
80278	2.5	25	250	>80	● 2700	15 000	E27	IP20	12
80279	2.5	25	250	>80	● 2700	15 000	E27	IP20	12
80286	2.5	25	250	>80	● 2700	15 000	E27	IP20	12
88610	2.5	101 - 240	250	80	● 2700	15 000	E27	IP20	12
88612	2.5	102 - 240	250	80	● 2700	15 000	E27	IP20	12
88613	2.5	104 - 240	250	80	● 2700	15 000	E27	IP20	12
88614	2.5	100 - 240	250	80	● 2700	15 000	E27	IP20	12
88622	2.5	100 - 240	250	80	● 2700	15 000	E27	IP20	12
88624	2.5	100 - 240	250	80	● 2700	15 000	E27	IP20	12
88626	2.5	100 - 240	250	80	● 2700	15 000	E27	IP20	12

* En sustitución de lámparas incandescentes / Replacing incandescent lamps.



LED FILAMENT SPECIAL

La familia de lámparas LED FILAMENT es ideal para aplicaciones decorativas, donde se quiera dar un toque especial, gracias a sus diseños únicos, creando ambientes de confort y tranquilidad

The family of LED FILAMENT lamps are ideal for decorative applications, where you want to give a special touch thanks to their unique designs, creating environments of comfort and tranquility



80290



80291



88637



80293



80294



80295

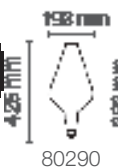

80290

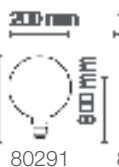

80291



80292



80293



80294



80295

APLICACIONES / APPLICATIONS



Salas
Living rooms



Hoteles
Hotels



Restaurantes
Restaurants

Código Sku	Potencia Power (W)	Equivalencia Inc. (W)	Flujo Luminoso Luminous Flux (lm)	IRC CRI	Temp. Color Color Temp. (K)	Vida Útil Life (h)	Base Base	Protección Protection	Unidades por Caja Units per box
88636	5	25	90	>80	● 1800	15 000	E27	IP20	2
80291	5	25	250	>80	○ 4000	15 000	E27	IP20	2
80293	5	25	350	>80	● 2000	15 000	E27	IP20	4
80294	2	25	225	>80	● 2500	15 000	E27	IP20	5
80295	5	25	250	>80	● 2000	15 000	E27	IP20	12
88636	4.5	127-220	90	80	● 1800	15 000	E27	IP20	2
88637	5	127-220	350	80	● 2000	15 000	E27	IP20	2
88634	5	127-220	300	80	○ 4000	15 000	E27	IP20	2
88638	4.5	127-220	300	80	● 2000	15 000	E27	IP20	4
88635	4.5	127-220	300	80	● 2500	15 000	E27	IP20	6
88639	4.5	127-220	250	80	● 2000	15 000	E27	IP20	12

* En sustitución de lámparas incandescentes / Replacing incandescent lamps.



LED HIGH WATTAGE SUPERSTAR®

La familia de LED Alta Potencia con base E27 son una excelente solución para la sustitución de lámparas fluorescentes ahorradoras compactas, ideales para aplicaciones residenciales y comerciales.

LED HIGH WATTAGE SUPERSTAR products are suitable for residential and commercial applications, replacing high wattage compact fluorescent lamps up to 80W. Direct replacement with E27 base.



HASTA
50%
DE AHORRO
DE ENERGÍA

3
AÑOS DE
GARANTÍA

HASTA
25 000h
VIDA ÚTIL

100-240 V~

ALTO FLUJO LUMINOSO

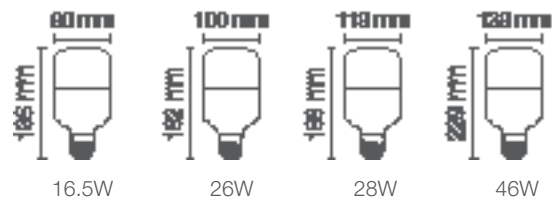

APLICACIONES / APPLICATIONS



Código Sku	Potencia Power (W)	Equivalencia Equivalence CFLi. (W)	Flujo Luminoso Luminous Flux (lm)	IRC CRI	Temp. Color Color Temp. (K)	Vida Útil Life (h)	Acabado Product Finishing	Base Base	Atenuable Dimmable	Dimensiones Dimensions (mm)	Unidades por Caja Units per box
80904	16.5 W	30	1 800	>80	● 6500	25 000	Opalino	E27	No	Ø 80 x 136	12
85825	26 W	45	2 800	>80	● 6500	25 000	Opalino	E27	No	Ø 100 x 162	12
80906	28 W	65	3 700	>80	● 6500	25 000	Opalino	E27	No	Ø 118 x 186	6
85827	46 W	80	4 850	>80	● 6500	25 000	Opalino	E27	No	Ø 138 x 229	6

* En sustitución de lámparas incandescentes / Replacing incandescent lamps.



LED HIGH WATTAGE ECO

La familia de LED High Wattage Eco con base E27 es una excelente sustitución de lámparas fluorescentes ahorradoras compactas, ofreciendo una solución funcional a tu alcance.

The ECO HIGH POWER LED family with E27 base is an excellent replacement for compact energy saving fluorescent lamps, offering a functional solution at your fingertips.



HASTA
50%
DE AHORRO
DE ENERGÍA

3
AÑOS DE
GARANTÍA

HASTA
10 000h
VIDA ÚTIL

120 V~

ALTO FLUJO
LUMINOSO

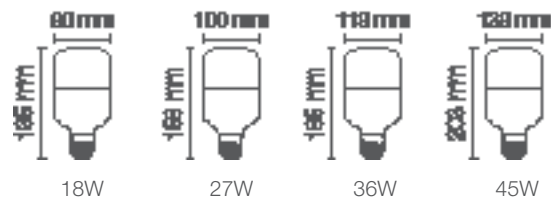

APLICACIONES / APPLICATIONS



Código Sku	Potencia Power (W)	Equivalencia Equivalence CFLI. (W)	Flujo Luminoso Luminous Flux (lm)	IRC CRI	Temp. Color Color Temp. (K)	Vida Útil Life (h)	Acabado Product Finishing	Base Base	Atenuable Dimmable	Dimensiones Dimensions (mm)	Unidades por Caja Units per box
80579	18	30	1 800	>80	● 6500	10 000	Opalino	E27	No	80 x 135	8
80580	27	45	2 800	>80	● 6500	10 000	Opalino	E27	No	100 x 158	8
80581	36	65	3 800	>80	● 6500	10 000	Opalino	E27	No	118 x 185	8
80582	45	80	4 850	>80	● 6500	10 000	Opalino	E27	No	138 x 203	8

* En sustitución de lámparas incandescentes / Replacing incandescent lamps.



LED HIGH WATTAGE E40 SUPERSTAR®

La familia de lámparas de altas potencias con base E40 es ideal para bodegas, almacenes, establecimientos o aplicaciones industriales para sustituir lámparas de aditivos metálicos y ahorrar hasta 50% en el consumo eléctrico. Disponibles en base mogúl (E40) y voltaje 100-277 V~. Solo para interiores.

LED HIGH WATTAGE E40 SUPERSTAR are perfect for indoor industrial applications replacing traditional technologies like mercury or sodium lamps saving energy up to 50% and high voltage range (100-277 V~).



- HASTA
63%
DE AHORRO
DE ENERGÍA
- 3**
AÑOS DE
GARANTÍA
- HASTA
25 000h
VIDA ÚTIL
- 100 - 277 V~
- ALTO FLUJO
LUMINOSO



APLICACIONES / APPLICATIONS



Código Sku	Potencia Power (W)	Equivalencia Equivalence CFLI. (W)	Flujo Luminoso Luminous Flux (lm)	IRC CRI	Temp. Color Color Temp. (K)	Vida Útil Life (h)	Acabado Product Finishing	Base Base	Atenuable Dimmable	Dimensiones Dimensions (mm)	Unidades por Caja Units per box
86293	65	100	5 800	>80	6500	25 000	Opalino	E40	No	145 x 217	4
86294	80	125	7 800	>80	6500	25 000	Opalino	E40	No	170 x 229	4
86295	100	175	9 500	>80	6500	25 000	Opalino	E40	No	190 x 270	2
86296	120	250	12 000	>80	6500	25 000	Opalino	E40	No	190 x 270	2

* En sustitución de lámparas incandescentes / Replacing incandescent lamps.



LED UFO E40 SUPERSTAR®

Alto flujo luminoso, sustitución de lámparas tradicionales como lámparas de mercurio hasta 250 W. Altura de montaje recomendable hasta 8 metros. Bajo consumo de energía. Base Mogúl (E40).

High luminous flux, perfect replacement for traditional technologies up to 250W. Ideal mounting height is up to 8 meters with energy saving up to 70% and high CRI >80.



80W • 92W

150W

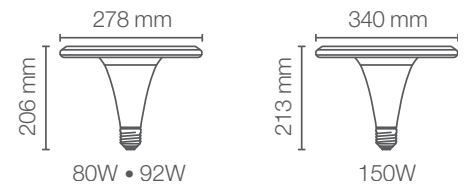

80W • 92W

150W

APLICACIONES / APPLICATIONS



Código Sku	Potencia Power (W)	Equivalencia Inc. (W)	Flujo Luminoso Luminous Flux (lm)	IRC CRI	Temp. Color Color Temp. (K)	Vida Útil Life (h)	Base Base	Atenuable Dimmable	Dimensiones Dimensions (mm)	Unidades por Caja Units per box
88149	80	175	8 500	>80	6500	25 000	E40	No	278 x 206	2
88150	92	250	12 000	>80	6500	25 000	E40	No	278 x 206	2
88151	150	400	18 000	>80	6500	25 000	E40	No	340 x 213	2

* En sustitución de lámparas de aditivo metálico. / Replacing metal halide lamps.



LED PIN BASE SUPERSTAR®

Las lámparas LED PIN BASE SUPERSTAR son ideales para aplicaciones comerciales, brindando un ahorro de energía de hasta 50% con una vida útil de 30 000 horas de vida garantizando años de servicio y reducción de costos de mantenimiento. Es el perfecto sustituto de lámparas fluorescentes pin base con base G24Q, 2G11, G23 y 2G7. Driver integrado con rango de voltaje de 120-277 V~.

LED PIN BASE SUPERSTAR are perfect for commercial applications, offering an energy saving up to 50% with 30 000 hours life guarantying years of service and maintenance saving costs. Perfect replacement for fluorescent pin base lamps with G24Q, 2G11, G23 and 2G7 base.

No external ballast or driver needed. Voltage range of 120-277 V~.

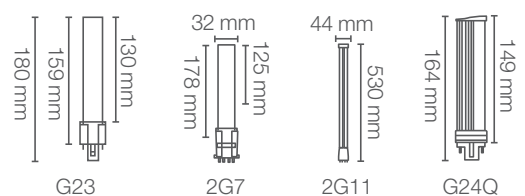

APLICACIONES / APPLICATIONS



Código Sku	Potencia Power (W)	Equivalencia Equivalence Inc. (W)	Flujo Luminoso Luminous Flux (lm)	IRC CRI	Temp. Color Color Temp. (K)	Vida Útil Life (h)	Acabado Product Finishing	Base Base	Atenuable Dimmable	Dimensiones Dimensions (mm)	Unidades por Caja Units per box
85191	6	13 (Dulux S)	490	>80	● 2700	30 000	Opalino	G23	No	159	20
85192	6	13 (Dulux S)	540	>80	○ 4000	30 000	Opalino	G23	No	159	20
85195	6	13 (Dulux SE)	540	>80	○ 4000	30 000	Opalino	2G7	No	32 x 171	20
80115	17	40 (Dulux L)	2 200	>80	○ 4000	30 000	Opalino	2G11	No	44 x 530	30
80118	8	26 (Dulux DE)	800	>80	○ 4000	30 000	Opalino	G24Q	No	149	50

MTO

* En sustitución de lámparas fluorescentes / Replacing fluorescent lamps.

SPOT



LED AR111 SUPERSTAR®

Las lámparas de LED AR111 SUPERSTAR combinan con un diseño tradicional de halógeno con tecnología innovadora. Cuentan con driver integrado con un rango de voltaje de 100-240 V~. Disponibles en base G53 y GU10 con 24° y 40°, además con opción no atenuable y atenuable.

*Ideales para luminarias LEDVANCE Tracklight y LEDVANCE Multispot.



TRACKLIGHT



MULTISPOT



LED AR111 SUPERSTAR products have a traditional halogen design with new LED technology. Does not need any external ballast or driver to operate. Voltage range of 100-240 V~. Available at G53 and GU10 base with 24° and 40°, additionally with dimmable and not dimmable version.

*Ideal for LEDVANCE Tracklight and LEDVANCE Multispot Luminaires.

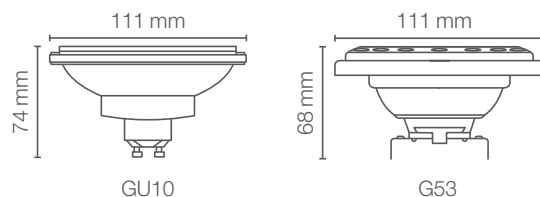

APLICACIONES / APPLICATIONS



Código Sku	Potencia Power (W)	Equivalencia Equivalence Halógena (W)	Flujo Luminoso Luminous Flux (lm)	Ángulo de Apertura Opening Angle	IRC CRI	Temp. Color Color Temp. (K)	Vida Útil Life (h)	Base Base	Atenuable Dimmable	Dimensiones Dimensions (mm)	Unidades por Caja Units per box
86354	12	75	950	24°	>80	2700	25 000	GU10	No	111 x 74	12
86355	12	75	950	24°	>80	2700	25 000	GU10	Si	111 x 74	12
86356	12	75	950	40°	>80	2700	25 000	GU10	Si	111 x 74	12
86357	12	75	950	40°	>80	2700	25 000	G53	Si	111 x 68	12

* En sustitución de lámparas halógenas / Replacing halogen lamps.



LED SUPERIOR AR111 IRC90

Las lámparas AR111 aseguran una iluminación profesional, debido a su alto IRC (90), ideal para boutiques, showrooms, galerías, museos, etc. donde se requiera una alta fidelidad de color.

*Ideales para luminarias LEDVANCE Tracklight y LEDVANCE Multispot.



TRACKLIGHT



MULTISPOT



The AR111 lamps ensure professional lighting, due to its high IRC (90), ideal for boutiques, showrooms, galleries, museums, etc. where high color fidelity is required.

*Ideal for LEDVANCE Tracklight and LEDVANCE Multispot Luminaires.

- HASTA
90%
DE AHORRO
DE ENERGÍA**
- 3
AÑOS DE
GARANTÍA**
- HASTA
25 000h
VIDA ÚTIL
GU10**
- 100 ~ 277 V~**

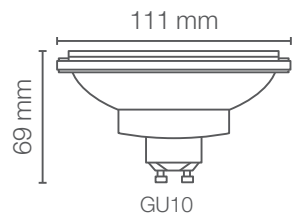

APLICACIONES / APPLICATIONS

- 
 Hoteles
Hotels
- 
 Establecimientos
Shops
- 
 Restaurantes
Restaurants
- 
 Hospitales
Hospitality

Código SKU	Potencia Power (W)	Equivalencia Equivalence Halógena (W)	Flujo Luminoso Luminous Flux (lm)	Ángulo de Apertura Opening Angle	IRC CRI	Temp. Color Color Temp. (K)	Vida Útil Life (h)	Base	Atenuable Dimmable	Dimensiones Dimensions (mm)	Unidades por Caja Units per box
80176	10	75	750	12°	>90	● 2700	25 000	GU10	No	111 x 69	12
80177	10	75	750	24°	>90	● 2700	25 000	GU10	No	111 x 69	12

* En sustitución de lámparas halógenas / Replacing halogen lamps.



LED MR16 VALUE®

La familia LED MR16 Value es ideal para iluminación de acento en aplicaciones residenciales y comerciales, disponible en temperatura: Luz Cálida (2700 K), (3000 K), Luz Neutra (4000 K) y Luz Fría (6500 K). Reemplazan a la tecnología de halógeno de 50 W. ¡Incluye porta lámpara para evitar accidentes!

LED MR16 VALUE products are perfect for accent lighting at residential and hospitality applications. Available in Temperatures (2700 K), (3000 K), (4000 K) and (6500 K). Includes lamp holder to avoid accidents!

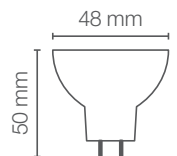

APLICACIONES / APPLICATIONS



Código Sku	Potencia Power (W)	Equivalencia Equivalence Halógena (W)	Flujo Luminoso Luminous Flux (lm)	Ángulo de Apertura Opening Angle	IRC CRI	Temp. Color Color Temp. (K)	Vida Útil Life (h)	Base Base	Protección Protection	Unidades por Caja Units per box
85987	5	50	400	36°	>80	● 2700	15 000	GU5.3	IP20	12
85886	5	50	400	36°	>80	● 3000	15 000	GU5.3	IP20	12
85988	5	50	400	36°	>80	○ 4000	15 000	GU5.3	IP20	12
85897	5	50	450	36°	>80	● 6500	15 000	GU5.3	IP20	12
85139	5	100 - 240	400	36°	80	● 2700	15 000	GU5.3	IP20	12
85140	5	100 - 240	400	36°	80	● 3000	15 000	GU5.4	IP20	12
85141	5	100 - 240	400	36°	80	○ 4000	15 000	GU5.5	IP20	12
85142	5	100 - 240	400	36°	80	● 6500	15 000	GU5.6	IP20	12

* En sustitución de lámparas halógenas / Replacing halogen lamps.



LED PAR16 SUPERSTAR®

Las lámparas PAR16 SUPERSTAR son ideales para destacar objetos (cuadros, esculturas, rasgos arquitectónicos, etc) y lugares (baños de luz en las paredes y la luz de teatro).

LED PAR16 SUPERSTAR lamps are ideal for highlighting objects (paintings, sculptures, architectural features, etc) and places (light baths on the walls and theater light). Available in dimmable version.

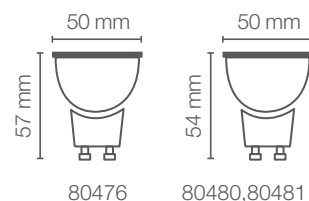

APLICACIONES / APPLICATIONS



Código Sku	Potencia Power (W)	Equivalencia Equivalence Halógena (W)	Voltaje Voltage (V)	Flujo Luminoso Luminous Flux (lm)	Ángulo de Apertura Opening Angle	IRC CRI	Temp. Color Color Temp. (K)	Vida Util Life (h)	Base Base	Atenuable Dimmable	Dimensiones Dimensions (mm)	Unidades por Caja Units per box
80476	5.5	60	127	550	35°	>80	2700	25 000	GU10	Si	50 x 57	12
80481	6	60	100-240	550	35°	>80	6500	25 000	GU10	No	54 x 50	12

* En sustitución de lámparas halógenas / Replacing halogen lamps.



LED PAR16 SUPERSTAR® IRC90

Las lámparas PAR16 aseguran una iluminación profesional, debido a su alto IRC >90, ideal para boutiques, showrooms, galerías, museos, etc. donde se requiera una alta fidelidad de color.



The AR11 lamps ensure professional lighting, due to its high IRC (90%), ideal for boutiques, showrooms, galleries, museums, etc. where high color fidelity is required

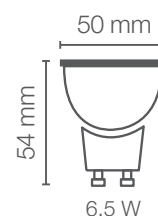

- HASTA
90%
DE AHORRO
DE ENERGÍA**
- 3
AÑOS DE
GARANTÍA**
- HASTA
25 000h
VIDA ÚTIL**
- 100 – 240 V~**



APLICACIONES / APPLICATIONS

- 
Establecimientos
Shops
- 
Hoteles
Hotels
- 
Restaurantes
Restaurants

Código Sku	Potencia Power (W)	Equivalencia Equivalence Halógena (W)	Flujo Luminoso Luminous Flux (lm)	Ángulo de Apertura Opening Angle	IRC CRI	Temp. Color Color Temp. (K)	Vida Útil Life (h)	Base Base	Atenuable Dimmable	Dimensiones Dimensions (mm)	Unidades por Caja Units per box
80478	6.5	60	525	35°	>90	● 2700	25 000	GU10	No	50 x 54	12
80479	6.5	60	550	35°	>90	● 6500	25 000	GU10	No	50 x 54	12

* En sustitución de lámparas halógenas / Replacing halogen lamps.



LED PAR16 RGBW®

La familia LED RGBW es un sistema de iluminación comandado vía control remoto que cuenta con atenuación de intensidad y cambio de colores, personaliza tus ambientes con un estilo único.

LED RGBW REMOTE CONTROL products are a special illumination system controlled by infrared remote control with dimmable controls and change of some colors to personalize your spaces with an unique style with dimming control.



4.5W

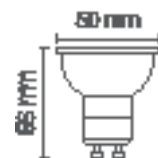

APLICACIONES / APPLICATIONS



Código Sku	Potencia Power (W)	Flujo Luminoso Luminous Flux (lm)	Ángulo de Apertura Opening Angle	IRC CRI	Temp. Color Color Temp. (K)	Vida Útil Life (h)	Base Base	Atenuable Dimmable	Dimensiones Dimensions (mm)	Unidades por Caja Units per box
88066	4.5	250	36°	>80	2700 + RGBW	15 000	GU10	Si**	50 x 56	12

* En sustitución de lámparas incandescentes / Replacing incandescent lamps.

** Atenuable únicamente mediante control remoto (incluido) / Dimmable only by remote control (included).



LED PAR16 VALUE

Las lámparas PAR16 VALUE garantizan una correcta iluminación de acento en objetos o elementos arquitectónicos. Disponibles en Luz Cálida (2 700 K) y Luz Fría (6 500 K).

PAR16 VALUE lamps ensure correct accent lighting on architectural objects or elements. Available in Warm Light (2 700 K) and Cold Light (6 500 K).



PAR16

- HASTA
90%
DE AHORRO
DE ENERGÍA**
- 3
AÑOS DE
GARANTÍA**
- HASTA
25 000h
VIDA ÚTIL**
- 100-240 V~**

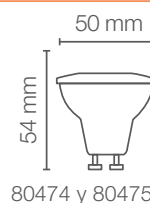

80474 y 80475

APLICACIONES / APPLICATIONS



Código Sku	Potencia Power (W)	Equivalencia Equivalence Halógena (W)	Flujo Luminoso Luminous Flux (lm)	Ángulo de Apertura Opening Angle	IRC CRI	Temp. Color Color Temp. (K)	Vida Útil Life (h)	Base Base	Atenuable Dimmable	Dimensiones Dimensions (mm)	Unidades por Caja Units per box
80474	4	50	350	35°	>80	● 2700	25 000	GU10	No	50 x 54	12
80475	4	50	370	35°	>80	● 6500	25 000	GU10	No	50 x 54	12

* En sustitución de lámparas halógenas / Replacing halogen lamps.



LED PAR20 SUPERSTAR®

Las lámparas PAR20 SUPERSTAR en su versión atenuable, son ideales para denotar objetos y lugares en temperatura Luz Cálida (2 700 K) y Luz Fría (6 500 K).

PAR20 SUPERSTAR lamps in their dimmable version, are ideal for denoting objects and places in warm light temperature (2 700 K) and Cold Light (6 500 K).



PAR20

- HASTA 90% DE AHORRO DE ENERGÍA**
- 3 AÑOS DE GARANTÍA**
- HASTA 25 000h VIDA ÚTIL**
- 127 V~**
- ATENUABLE***

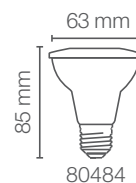

APLICACIONES / APPLICATIONS

- Ambientes residenciales
Residential environments
- Hoteles
Hotels
- Pasillos
Corridors
- Establecimientos
Shops
- Museos / Galerías
Museums / Galleries

Código Sku	Potencia Power (W)	Equivalencia Equivalence Halógena (W)	Voltaje Voltage (V~)	Flujo Luminoso Luminous Flux (lm)	Ángulo de Apertura Opening Angle	IRC CRI	Temp. Color Color Temp. (K)	Vida Útil Life (h)	Base Base	Atenuable Dimmable	Dimensiones Dimensions (mm)	Unidades por Caja Units per box
80484	6	50	127	525	25°	>80	● 2700	25 000	E27	Si	63 x 85	12

* En sustitución de lámparas halógenas / Replacing halogen lamps.



LED PAR20 VALUE

Las lámparas PAR20 VALUE garantizan una correcta iluminación de acento en objetos o elementos arquitectónicos. Disponibles en Luz Cálida (2 700 K) y Luz Fría (6 500 K).

PAR20 VALUE lamps ensure correct accent lighting on architectural objects or elements. Available in Warm Light (2 700 K) and Cold Light (6 500 K).



PAR20

- HASTA
90%
DE AHORRO
DE ENERGÍA
- 3**
AÑOS DE
GARANÍA
- HASTA
25 000h
VIDA ÚTIL
- 100-240 V~

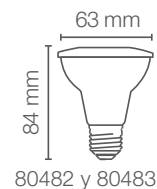

80482 y 80483

APLICACIONES / APPLICATIONS

- 
Ambientes residenciales
Residential environments
- 
Hoteles
Hotels
- 
Pasillos
Corridors
- 
Establecimientos
Shops
- 
Museos / Galerías
Museums / Galleries

Código Sku	Potencia Power (W)	Equivalencia Equivalence Halógena (W)	Flujo Luminoso Luminous Flux (lm)	Ángulo de Apertura Opening Angle	IRC CRI	Temp. Color Color Temp. (K)	Vida Útil Life (h)	Base Base	Atenuable Dimmable	Dimensiones Dimensions (mm)	Unidades por Caja Units per box
80482	5.5	50	525	40°	>80	● 2700	25 000	E27	No	63 x 84	12
80483	5.5	50	550	40°	>80	● 6500	25 000	E27	No	63 x 84	12

* En sustitución de lámparas halógenas / Replacing halogen lamps.



LED PAR30 SUPERSTAR®

Las lámparas PAR30 SUPERSTAR atenuables son ideales para iluminación de acento en base E27, reemplaza a la tecnología de halógeno de 75 W.

The dimmable PAR30 SUPERSTAR lamps are ideal for accent lighting on E27 base, replace the 75 W halogen technology.



83026



83150 y 80486

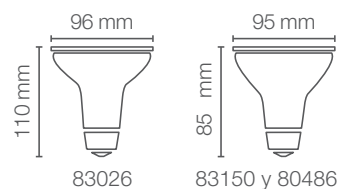

APLICACIONES / APPLICATIONS



Código Sku	Potencia Power (W)	Equivalencia Equivalence Halógena (W)	Voltaje Voltage (V~)	Flujo Luminoso Luminous Flux (lm)	Ángulo de Apertura Opening Angle	IRC CRI	Temp. Color Color Temp. (K)	Vida Útil Life (h)	Base Base	Atenuable Dimmable	Dimensiones Dimensions (mm)	Unidades por Caja Units per box
83026	12	26	120	900	40°	>80	3000	25 000	E27	No	96 x 110	6
83150	9	75	120	800	40°	>80	3000	25 000	E27	Si	95 x 85	10
80486	9.5	75	127	900	25°	>80	2700	25 000	E27	Si	95 x 85	12

* En sustitución de lámparas halógenas / Replacing halogen lamps.



LED PAR30 SUPERSTAR® IP65

Las lámparas PAR30 SUPERSTAR son ideales para iluminación de acento en exteriores, ya que cuentan con IP65, disponibles en Temperatura de color Cálida (2 700 K y 3 000 K) y Luz Fría (6 500 K).

PAR30 SUPERSTAR lamps are ideal for outdoor accent lighting as it has IP65, available in Warm color temperature (2 700 K and 3 000 K) and Cold Light (6 500 K).



80490 / 80491

80492 / 80493

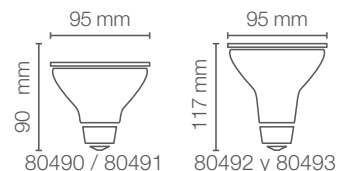

APLICACIONES / APPLICATIONS



Código Sku	Potencia Power (W)	Equivalencia Equivalence Halógena (W)	Flujo Luminoso Luminous Flux (lm)	Ángulo de Apertura Opening Angle	IRC CRI	Temp. Color Color Temp. (K)	Vida Útil Life (h)	Base Base	Atenuable Dimmable	Dimensiones Dimensions (mm)	Unidades por Caja Units per box
80490	9.5	75	900	25°	>80	2700	25 000	E27	No	95 x 90	12
80491	9.5	75	1000	25°	>80	6500	25 000	E27	No	95 x 90	12
80492	9.5	75	900	25°	>80	2700	25 000	E27	No	95 x 117	12
80493	9.5	75	1000	25°	>80	6500	25 000	E27	No	95 x 117	12

* En sustitución de lámparas halógenas / Replacing halogen lamps.



LED PAR30 HCI SUPERSTAR®

Las lámparas LED PAR30 HCI SUPERSTAR son ideales para aplicaciones comerciales y profesionales, ya que cuentan con alto flujo luminoso de hasta 3100 lúmenes con opciones de IRC 80 e IRC 90 con base E27. Disponible en 15° y 30° en temperaturas de color desde 3000 K hasta 6500 K, sustituyendo lámparas de aditivos metálicos cerámicos HCI PAR30 de 70 W.

LED PAR30 HCI SUPERSTAR are perfect for commercial and professional applications due high luminous flux up to 3100lm with two options of CRI of 80 and 90 with E27 base. Available in 15° and 30° and color temperatures from 3000 K up to 6500 K, the perfect replacement for 70 W PAR30 HCI Halogen Lamps.



IRC 90



IRC 80

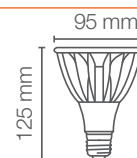

APLICACIONES / APPLICATIONS

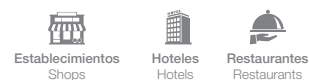

Código Sku	Potencia Power (W)	Equivalencia Equivalence Halógena (W)	Flujo Luminoso Luminous Flux (lm)	Ángulo de Apertura Opening Angle	IRC CRI	Temp. Color Color Temp. (K)	Vida Útil Life (h)	Base Base	Protección Protection	Unidades por Caja Units per box
88494	28	100 - 277	3 000	15°	>80	● 3000	15 000	E27	IP20	12
88495	28	100 - 277	3 000	15°	>80	○ 4000	15 000	E27	IP20	12
88496	28	100 - 277	3 000	15°	>80	● 6500	15 000	E27	IP20	12
88497	28	100 - 277	3 000	30°	>80	● 3000	15 000	E27	IP20	12
88498	28	100 - 277	3 000	30°	>80	○ 4000	15 000	E27	IP20	12
88138	28	100 - 277	3 000	30°	>80	● 6500	15 000	E27	IP20	12
88499	28	100 - 277	3 000	30°	>80	● 6500	15 000	E27	IP20	12
87959	37	100 - 277	3 100	15°	>90	○ 4000	15 000	E27	IP20	12
88500	28	100 - 277	3 000	15°	>90	● 3000	15 000	E27	IP20	12
88501	28	100 - 277	3 000	15°	>90	○ 4000	15 000	E27	IP20	12
88502	28	100 - 277	3 000	30°	>90	● 3000	15 000	E27	IP20	12
88503	28	100 - 277	3 000	30°	>90	○ 4000	15 000	E27	IP20	12

* En sustitución de lámparas halógenas / Replacing halogen lamps.



LED PAR30 VALUE

La familia LED Superstar PAR30 es ideal para usos comerciales ya que su acentuación direccional ofrece calidad de luz inigualable.

Disponibles en temperatura:

Luz Cálida (2 700 K) y Luz Fría (6 500 K).

LED PAR30 SUPERSTAR products are perfect for indoor and outdoor applications with an unique accent offering a magnifical quality.

Available in Warm Light (2700 K) and Cold Light (6500 K).



PAR30

- HASTA**
85%
DE AHORRO DE ENERGÍA
- 3**
AÑOS DE GARANTÍA
- HASTA**
25 000h
VIDA ÚTIL
- 100 – 240 V~**

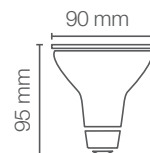

APLICACIONES / APPLICATIONS

- 
Ambientes residenciales
Residential environments
- 
Hoteles
Hotels
- 
Pasillos
Corridors
- 
Establecimientos
Shops
- 
Museos / Galerías
Museums / Galleries

Código Sku	Potencia Power (W)	Equivalencia Equivalence Halógena (W)	Flujo Luminoso Luminous Flux (lm)	Ángulo de Apertura Opening Angle	IRC CRI	Temp. Color Color Temp. (K)	Vida Útil Life (h)	Base Base	Dimensiones Dimensions (mm)	Unidades por Caja Units per box
80488	9.5	75	900	25°	>80	● 2700	25 000	E27	90 x 95	12
80489	9.5	75	940	25°	>80	● 6500	25 000	E27	90 x 95	12

* En sustitución de lámparas halógenas / Replacing halogen lamps.



LED PAR38 SUPERSTAR® IP65

Las lámparas PAR38 SUPERSTAR son ideales para iluminación de acento en exteriores, ya que cuentan con IP65, disponibles en Temperatura de color Cálida (2 700 K y 3 000 K) y Luz Fría (6 500 K).

PAR38 SUPERSTAR lamps are ideal for outdoor accent lighting as it has IP65, available in Warm color temperature (2 700 K and 3 000 K) and Cold Light (6 500 K).



80496 / 80497

- HASTA
80%
DE AHORRO
DE ENERGÍA**
- 3
AÑOS DE
GARANTÍA**
- HASTA
25 000h
VIDA ÚTIL**
- IP 65**
- 100-277 V~**

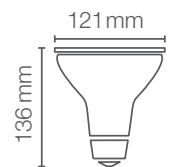

80496 y 80497

APLICACIONES / APPLICATIONS

- Ambientes residenciales
Residential environments
- Hoteles
Hotels
- Pasillos
Corridors
- Establecimientos
Shops
- Museos / Galerías
Museums / Galleries
- Jardines
Gardens

Código Sku	Potencia Power (W)	Equivalencia Equivalence Halógena (W)	Flujo Luminoso Luminous Flux (lm)	Ángulo de Apertura Opening Angle	IRC CRI	Temp. Color Color Temp. (K)	Vida Útil Life (h)	Base Base	Atenuable Dimmable	Dimensiones Dimensions (mm)	Unidades por Caja Units per box
80496	13.5	90	1 400	30°	>80	● 2700	25 000	E27	No	121 x 136	12
80497	13.5	90	1 600	30°	>80	● 6500	25 000	E27	No	121 x 136	12

* En sustitución de lámparas halógenas / Replacing halogen lamps.



LED PAR38 VALUE

La familia LED Superstar PAR38 es ideal para usos comerciales ya que su acentuación direccional ofrece calidad de luz inigualable. Disponibles en temperatura: Luz Cálida (2 700 K) y Luz Fría (6 500 K).

LED PAR38 SUPERSTAR products are perfect for indoor and outdoor applications with an unique accent offering a magnificent quality. Available in Warm Light (2700 K) and Cold Light (6500 K).



PAR38

- HASTA**
85%
DE AHORRO
DE ENERGÍA
- 3**
AÑOS DE
GARANTÍA
- HASTA**
25 000h
VIDA ÚTIL
- 100 – 240 V~**

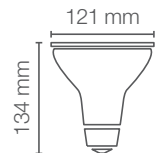

APLICACIONES / APPLICATIONS

- 
Ambientes residenciales
Residential environments
- 
Hoteles
Hotels
- 
Pasillos
Corridors
- 
Establecimientos
Shops
- 
Museos / Galerias
Museums / Galleries

Código Sku	Potencia Power (W)	Equivalencia Equivalence Halógena (W)	Flujo Luminoso Luminous Flux (lm)	Ángulo de Apertura Opening Angle	IRC CRI	Temp. Color Color Temp. (K)	Vida Útil Life (h)	Base Base	Dimensiones Dimensions (mm)	Unidades por Caja Units per box
80494	13.5	90	1400	30°	>80	● 2700	25 000	E27	121 x 134	12
80495	13.5	90	1500	30°	>80	● 6500	25 000	E27	121 x 134	12

* En sustitución de lámparas halógenas / Replacing halogen lamps.



TUBOS LED



LED T8 SUPERIOR

Las lámparas LED T8 SUPERIOR son ideales para aplicaciones comerciales y corporativas debido a su alto rango de voltaje (120-277 V~) y hasta 50,000 horas de vida. No necesita driver o balastro externo. Disponibles en 120cm y en todas las temperaturas de color. Material de vidrio.

LED T8 SUPERIOR products are perfect for commercial, industrial and corporate application due to wide voltage range (120-277 V~) and high hours life up to 50,000 hours. Does not need external ballast or driver. Available in 120 cm and all color temperatures. Glass material.



APLICACIONES / APPLICATIONS



	Código Sku	Potencia Power (W)	Equivalencia Fluor. (W)	Flujo Luminoso Luminous Flux (lm)	IRC CRI	Temp. Color Color Temp. (K)	Vida Útil Life (h)	Acabado Product Finishing	Base Base	Dimensiones Dimensions (mm)	Unidades por Caja Units per box
MTO	80109	17	32 W	2 200	>82	● 5000	50 000	Opalino	G13	1212 x 26	25
MTO	80110	17	32 W	2 200	>82	● 3000	50 000	Opalino	G13	1212 x 26	25
MTO	80111	17	32 W	2 200	>82	○ 4000	50 000	Opalino	G13	1212 x 26	25
MTO	80112	17	32 W	2 200	>82	● 6500	50 000	Opalino	G13	1212 x 26	25

* En sustitución de lámparas fluorescentes tubulares. / Replacing tubular fluorescent lamps.



LED T8 SUPERSTAR®

Las lámparas LED T8 SUPERSTAR son ideales para aplicaciones comerciales y corporativas debido a su alto rango de voltaje (100-277 V~) y hasta 40,000 horas de vida. No necesita driver o balastro externo. Disponibles en 60cm y 120cm. Material de vidrio.

LED T8 SUPERSTAR products are perfect for industrial application due to wide voltage range (100-277 V~) and high hours life up to 40,000 hours. Does not need external ballast or driver. Available in 2ft and 4ft. Glass material.



HASTA
50%
DE AHORRO
DE ENERGÍA

3
AÑOS DE
GARANTÍA

HASTA
40 000h
VIDA ÚTIL

100 - 277 V~

3000K
4000K

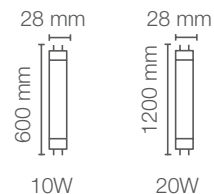

APLICACIONES / APPLICATIONS

- Establecimientos
Shops
- Oficinas/Escuelas
Offices/Schools
- Hospitales
Hospitality
- Pasillos
Corridors
- Cocheras
Garages
- Hangares
Hangars
- Estacionamientos
Parking lots

Código SKU	Potencia Power (W)	Equivalencia Equivalence Fluor. (W)	Flujo Luminoso Luminous Flux (lm)	IRC CRI	Temp. Color Color Temp. (K)	Vida Útil Life (h)	Base Base	Protección Protection	Unidades por Caja Units per box
86350	19	100 - 273	2 000	>80	● 3000	40 000	G13	IP20	25
86351	19	100 - 274	2 000	>80	○ 4000	40 000	G13	IP21	25
86352	19	100 - 275	2 000	>80	● 5000	40 000	G13	IP22	25
86352	19	100 - 276	2 000	>80	● 6500	40 000	G13	IP23	25

* En sustitución de lámparas fluorescentes tubulares. / Replacing tubular fluorescent lamps.



LED T8 SUPERSTAR® SENSOR

Las lámparas LED T8 SUPERSTAR SENSOR son ideales para aplicaciones comerciales y corporativas debido a su alto rango de voltaje (100-277 V~), cuenta con un sensor microondas de 5m y hasta 25,000 horas de vida. No necesita driver o balastro externo. Disponibles en 60cm y 120cm y en todas las temperaturas de color. Material de vidrio.

LED T8 SUPERSTAR SENSOR products are perfect for industrial application due to wide voltage range (100-277 V~), it has a 5m microwave sensor and high hours life up to 25,000 hours. Does not need external ballast or driver. Available in 2ft and 4ft and all color temperatures. Glass material.



28 mm
1200 mm
18W

APLICACIONES / APPLICATIONS



Código Sku	Potencia Power (W)	Equivalencia Fluor. (W)	Flujo Luminoso Luminous Flux (lm)	IRC CRI	Temp. Color Color Temp. (K)	Vida Útil Life (h)	Acabado Product Finishing	Base Base	Dimensiones Dimensions (mm)	Unidades por Caja Units per box
80238	18	32	2 000	>80	○4000	25 000	Opalino	G13	1200 x 28	25
80239	18	32	2 000	>80	●6500	25 500	Opalino	G13	1200 x 28	25

* En sustitución de lámparas fluorescentes tubulares. / Replacing tubular fluorescent lamps.



TUBO LED T8 VALUE® G3

Los tubos de LED T8 VALUE son una solución versátil para todo tipo de aplicaciones con bajo consumo de energía. No necesitan balastro.

LED T8 VALUE ideal for versatile lighting solutions, saving energy up to 50%. Does not need external ballast or driver.



8W • 16W



16W Claro

- HASTA
50%
DE AHORRO
DE ENERGÍA**
- 2
AÑOS DE
GARANTÍA**
- HASTA
15 000h
VIDA ÚTIL**
- 100 – 277 V~**
- 3000K
4000K
5000K
6500K**

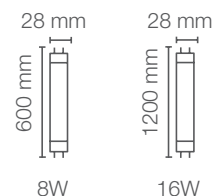

APLICACIONES / APPLICATIONS



Código SKU	Potencia Power (W)	Equivalencia Equivalence Fluor. (W)	Flujo Luminoso Luminous Flux (lm)	IRC CRI	Temp. Color Color Temp. (K)	Vida Útil Life (h)	Acabado Product Finishing	Base Base	Atenuable Dimmable	Dimensiones Dimensions (mm)	Unidades por Caja Units per box
88408	16	32	1 600	>80	● 3000	15 000	Opalino	G13	No	1200 x 28	25
88409	16	32	1 600	>80	○ 4000	15 000	Opalino	G13	No	1200 x 28	25
88410	16	32	1 600	>80	● 5000	15 000	Opalino	G13	No	1200 x 28	25
88411	16	32	1 600	>80	● 6500	15 000	Opalino	G13	No	600 x 28	25
88412	8	17	800	>81	● 3000	15 000	Opalino	G13	No	600 x 28	25
88413	8	17	800	>82	○ 4000	15 000	Opalino	G13	No	600 x 28	25
88414	8	17	800	>83	● 5000	15 000	Opalino	G13	No	600 x 28	25
88415	8	17	800	>84	● 6500	15 000	Opalino	G13	No	600 x 28	25
88416	16	32	1 600	>80	○ 4000	15 000	Clear	G13	No	1200 x 28	25
88417	16	32	1 600	>80	● 6500	15 000	Clear	G13	No	1200 x 28	25

* En sustitución de lámparas fluorescentes tubulares. / Replacing tubular fluorescent lamps.



TUBO LED T8 ECO®

Los tubos de LED T8 ECO son una solución para aquellas aplicaciones con iluminación práctica y funcional ya que no necesitan balastro.

LED T8 ECO ideal for functional lighting solutions. Does not need external ballast or driver.



8W • 16W



16W Claro

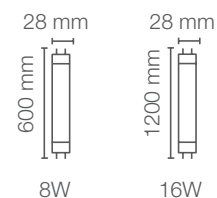

APLICACIONES / APPLICATIONS



Código Sku	Potencia Power (W)	Equivalencia Equivalence Fluor. (W)	Flujo Luminoso Luminous Flux (lm)	IRC CRI	Temp. Color Color Temp. (K)	Vida Útil Life (h)	Acabado Product Finishing	Base Base	Dimensiones Dimensions (mm)	Unidades por Caja Units per box
80186	8	17	800	>80	○ 4000	15 000	Opalino	G13	600 x 28	25
80189	16	32	1 440	>80	● 3000	15 000	Opalino	G13	1200 x 28	25
80192	16	32	1 600	>80	● 6500	15 500	Opalino	G13	1200 x 28	25

* En sustitución de lámparas fluorescentes tubulares. / Replacing tubular fluorescent lamps.



LED T8 CURVALUM SUPERSTAR®

Las lámparas LED T8 CURVALUM SUPERSTAR ofrecen el reemplazo ideal de tubos fluorescentes de 32W, cuentan con driver integrado ahorrando energía de hasta 50%. Driver integrado. Disponible en temperatura Luz Neutra (4000 K) y Luz Fría (6500 K).

LED T8 CURVALUM SUPERSTAR are the ideal fluorescent tubes substitution, offering integrated driver and saving energy up to 50%. Available in Neutral light (4000 K) and Cold Light (6500 K) temperature.



- HASTA
50%
DE AHORRO
DE ENERGÍA
- 3**
AÑOS DE
GARANTÍA
- HASTA
50 000h
VIDA ÚTIL
- 120 - 277 V~**

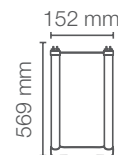

APLICACIONES / APPLICATIONS



Código Sku	Potencia Power (W)	Equivalencia Equivalence Fluor. (W)	Flujo Luminoso Luminous Flux (lm)	IRC CRI	Temp. Color Color Temp. (K)	Vida Útil Life (h)	Acabado Product Finishing	Base Base	Dimensiones Dimensions (mm)	Unidades por Caja Units per box
86341	18	32	2 200	>80	○ 4000	50 000	Opalino	G13	596 x 152	12
86342	18	32	2 200	>80	● 6500	50 000	Opalino	G13	596 x 152	12

* En sustitución de lámparas fluorescentes tubulares. / Replacing tubular fluorescent lamps.



LED T8 SLIM SUPERSTAR®

La lámpara LED T8 SLIM SUPERSTAR ofrece alto flujo luminoso, reemplazando T8 fluorescente Slimline de 59W. Driver integrado. Disponible en temperatura de Luz Fría (6500 K).

LED T8 SLIM SUPERSTAR offers high luminous flux, replacing T8 59W Slimline. Does not need external driver or ballast. Available at Cold Light temperature (6500 K).



28 mm
2373 mm
10W

APLICACIONES / APPLICATIONS



Pasillos
Corridors



Hangares
Hangars



Estacionamientos
Parking lots

Código Sku	Potencia Power (W)	Equivalencia Equivalence Fluor. (W)	Flujo Luminoso Luminous Flux (lm)	IRC CRI	Temp. Color Color Temp. (K)	Vida Útil Life (h)	Acabado Product Finishing	Base Base	Dimensiones Dimensions (mm)	Unidades por Caja Units per box
87900	36	60	3 600	>80	● 6500	30 000	Opalino	G13	2373 x 28	8

* En sustitución de lámparas fluorescentes tubulares. / Replacing tubular fluorescent lamps.



LED T5 SUPERSTAR®

Las lámparas LED T5 SUPERSTAR cuentan con 5 años de garantía y 50,000 horas de vida, el sustituto ideal de tubos fluorescentes T5 de 14W, 28W y 54W ahorrando energía de hasta 50%. Cuentan con driver integrado. Hasta una eficacia de 150 lm/W.

LED T5 SUPERSTAR products offer 5 warranty years and 50,000 hours life and integrated driver. The ideal substitution of 14W, 28W and 54W T5 Fluorescent tubes, saving energy up to 50%. Efficacy up to 150 lm/W.

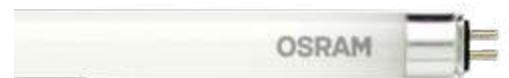

HASTA
50%
DE AHORRO
DE ENERGÍA

5
AÑOS DE
GARANTÍA

HASTA
50 000h
VIDA ÚTIL

100 – 277 V~

DE
G5

3000K
4000K
5000K
6500K

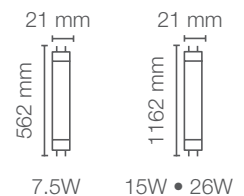

APLICACIONES / APPLICATIONS



Código Skü	Potencia Power (W)	Equivalencia Equivalence Fluor. (W)	Flujo Luminoso Luminous Flux (lm)	IRC CRI	Temp. Color Color Temp. (K)	Vida Útil Life (h)	Acabado Product Finishing	Base Base	Dimensiones Dimensions (mm)	Unidades por Caja Units per box
87892	7.5	17	900	>80	3000	50 000	Opalino	G5	562 x 21	25
85828	7.5	17	900	>80	4000	50 000	Opalino	G5	562 x 21	25
85829	7.5	17	900	>80	6500	50 500	Opalino	G5	562 x 21	25
85830	15	28	1 850	>80	3000	50 000	Opalino	G5	1162 x 21	25
85831	15	28	1 850	>80	4000	50 000	Opalino	G5	1162 x 21	25
85832	15	28	1 850	>80	5000	50 000	Opalino	G5	1162 x 21	25
85833	15	28	1 850	>80	6500	50 500	Opalino	G5	1162 x 21	25
85834	26	54	3 600	>80	3000	50 000	Opalino	G5	1162 x 21	25
85835	26	54	3 900	>80	4000	50 000	Opalino	G5	1162 x 21	25
85836	26	54	3 900	>80	5000	50 000	Opalino	G5	1162 x 21	25
85837	26	54	3 900	>80	6500	50 500	Opalino	G5	1162 x 21	25

* En sustitución de lámparas fluorescentes tubulares. / Replacing tubular fluorescent lamps.



ÍNDICE

COMPONENTES

ELECTRÓNICOS

LEDVANCE

TIRAS LED

TIRA ECOFLEX USB	136
TIRAS LED ECOFLEX 12V	137
DRIVERS ECOFLEX 12V	138
ACCESORIOS ECOFLEX	138
ECOKIT	139
TIRA LED ECOFLEX 127V	140
ACCESORIOS ECOFLEX 127V	141
TIRA LED PRIMEFLEX 24V	142
DRIVERS PRIMEFLEX 24V	143
ACCESORIOS PRIMEFLEX 24V	143
DRIVERS CS	144



SENSORES DE MOVIMIENTO

USO INTERIOR Y EXTERIOR	145
USO EXTERIOR INDUSTRIAL	146



FOTOCELDA

FOTOCELDA	147
-----------	-----



SISTEMAS DE EMERGENCIA

SISTEMAS DE EMERGENCIA	148
SISTEMAS DE CONTROL INALÁMBRICO	149



SISTEMAS DE CONTROL INALÁMBRICO

smARTlight[®]

GATEWAY BLE	150
CONTROL DE PARED BLE	150
SENSOR BLE	151
RELEVADORES BLE	151



SMART+

SMART+ LIGHTING	152
SMART+ FLOOR CORNER	153
SMART+ DESIGN PLAFON	154
SMART+ CEILING DECO	155
SMART+ SUSPENDING DECO	156





TIRA ECOFLEX USB

Nueva TIRA LED MULTICOLOR, ahora con conector USB que te permitirá alimentar la tira con cualquier dispositivo, además incluye control remoto con el cuál podrás controlar la iluminación.

New MULTICOLOR LED STRIP, now with a USB connector that will allow you to power the strip with any device, it also includes a remote control with which you can control the lighting.



2
AÑOS DE GARANTÍA

USB

2m
LONGITUD

CON CONTROL REMOTO

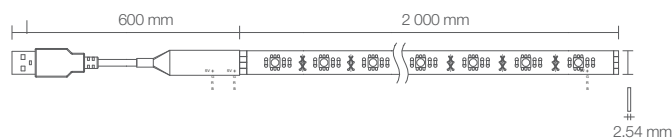

APLICACIONES / APPLICATIONS

- Salas
Living rooms
- Recámaras
Rooms
- Comedor
Dining room
- Cocina
Corridors
- Establecimientos
Shops
- Bar
Bar
- Centros de entretenimiento
Centers of entertainment

Código Sku	Potencia Power (W)	Flujo Luminoso Luminous Flux (lm/W)	Ángulo de Apertura Opening Angle	Temp. de Color Color Temp. (K)	Vida Útil Life (h)	IRC CRI	Dimensiones Dimensions (mm)	Color de Producto Product Color	Unidades por Caja Units per box
85226	2.5	25	120°	RGB	25 000	>70	2600 x 10 x 2.54	Blanco	12



TIRAS LED ECOFLEX 12V

Descubre la versatilidad que nuestras tiras ofrecen, ideal para iluminación de áreas interiores y exteriores, para crear ambientes únicos y resaltar detalles finos para darle un toque arquitectónico a los espacios, garantizando la misma tonalidad de luz a lo largo de su vida útil.

Discover the versatility that our strips offer, ideal for lighting indoor and outdoor areas, to create unique environments and highlight fine details to give an architectural touch to spaces, guaranteeing the same light tone throughout its useful life.



APLICACIONES / APPLICATIONS



Código Sku	Potencia/ m Power/m (W)	Flujo Luminoso Luminous Flux (lm/m)	Temp. Color Color Temp. (K)	Protección Protection	Vida Útil Life (h)	Uso Use	Dimensiones Dimensions (mm)	Unidades por Caja Units per box
86230	4.8	380	● 2700	IP20	20 000	Interior	5000 x 8 x 1.4	10
86231	4.8	400	○ 4000	IP20	20 000	Interior	5000 x 8 x 1.4	10
86232	4.8	400	● 6500	IP20	20 000	Interior	5000 x 8 x 1.4	10
86233	12	900	● 2700	IP20	20 000	Interior	5000 x 10 x 1.4	10
86235	12	950	○ 4000	IP20	20 000	Interior	5000 x 10 x 1.4	10
86236	12	950	● 6500	IP20	20 000	Interior	5000 x 10 x 1.4	10
86237	4.8	360	● 2700	IP65	20 000	Exterior	5025 x 10.3 x 4	10
86238	4.8	380	○ 4000	IP65	20 000	Exterior	5025 x 10.3 x 4	10
86239	4.8	380	● 6500	IP65	20 000	Exterior	5025 x 10.3 x 4	10
86240	12	850	● 2700	IP65	20 000	Exterior	5025 x 12.8 x 4.4	10
86242	12	900	● 6500	IP65	20 000	Exterior	5025 x 12.8 x 4.4	10

* No incluye driver. / Does not include driver.

DRIVERS ECOFLEX 12V

Complementa tu diseño de iluminación con tiras adicionando drivers de aplicación interior o exterior que energicen adecuadamente tus tiras ECOFLEX 12V.

Complement your lighting design with strips adding drivers for interior or exterior application that adequately energize your ECOFLEX 12V strips.

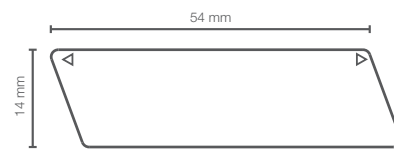
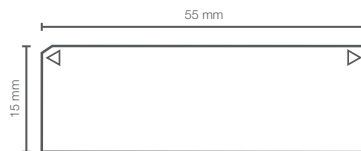

Código SKU	Potencia Power (W)	Parámetros de salida Output parameters		Protección Protection	Uso Use	Ideal para tiras Ideal for strips	Dimensiones Dimensions (mm)	Unidades por Caja Units per box
		Tensión (V)	Corriente (A)					
86316	30	12	2.5	IP20	Interior	ECOFLEX IP20	150 x 43 x 30	25
86317	60	12	5	IP20	Interior	ECOFLEX IP20	182 x 43 x 38	18
86318	30	12	2.5	IP67	Exterior	ECOFLEX IP65	146 x 40 x 29	15
86319	60	12	5	IP67	Exterior	ECOFLEX IP65	160 x 42 x 31	15

ACCESORIOS ECOFLEX 12V

Aumenta las posibilidades de instalación y diversifica tus diseños integrando conectores de fácil conexión: I, L, T y X.

Increase the installation possibilities and diversify your designs by integrating easy connection connectors: I, L, T and X.



Código SKU	Descripción Description	Uso Use	Ideal para tiras Ideal for strips	Unidades por Caja Units per box
88855	Conector I 8mm	Interior	ECOFLEX 4.8W IP20	20
88857	Conector L 8mm	Interior	ECOFLEX 4.8W IP20	20
88859	Conector T 8mm	Interior	ECOFLEX 4.8W IP20	20
88861	Conector X 8mm	Interior	ECOFLEX 4.8W IP20	20
88863	Plug de silicón 8mm	Exterior	ECOFLEX 4.8W IP65	20
83878	Conector de entrada macho 8mm	Exterior	ECOFLEX 4.8W IP65	20
88869	Tornillo para cintad LED	Exterior	ECOFLEX 4.8W & 12W IP65	20
88856	Conector I 10mm	Interior	ECOFLEX 12W IP20	20
88858	Conector L 10mm	Interior	ECOFLEX 12W IP20	20
88860	Conector T 10mm	Interior	ECOFLEX 12W IP20	20
88862	Conector X 10mm	Interior	ECOFLEX 12W IP20	20
88864	Plug de silicón 10mm	Exterior	ECOFLEX 12W IP65	20
88865	Conector de entrada hembra 10mm	Exterior	ECOFLEX 12W IP65	20
88866	Conector de entrada macho M13	Exterior	ECOFLEX 4.8W IP65 & 12W IP65	20
88867	Conector de entrada hembra M11	Exterior	ECOFLEX 4.8W IP65 & 12W IP65	20



ECOKIT

Kit de Tira LED + Driver de fácil instalación para crear diferentes escenarios y atmósferas confortables en interiores.

Easy to install LED Strip + Driver Kit to create different scenarios and comfortable atmospheres indoors.

2
AÑOS DE GARANTÍA

110 – 277 V~

5m
LONGITUD



APLICACIONES / APPLICATIONS



Cocinas
Kitchens



Pasillos
Corridors



Escaparate
Showcase



Oficinas
Offices



Escaleras
Stairs



Restaurantes
Restaurants

Código Sku	Potencia/ m Power/m (W)	Flujo Luminoso Luminous Flux (lm/m)	Temp. Color Color Temp. (K)	Protección Protection	Vida Útil Life (h)	Uso Use	Dimensiones Dimensions (mm)	Unidades por Caja Units per box
86243	4.8	380	● 2700	IP20	20 000	Interior	5000 x 8 x 1.4	10
86244	4.8	400	○ 4000	IP20	20 000	Interior	5000 x 8 x 1.4	10
86245	4.8	400	● 6500	IP20	20 000	Interior	5000 x 8 x 1.4	10



TIRAS LED ECOFLEX 127V

Integra tiras de LED a tus diseños exteriores y rediseña tus espacios, con la posibilidad de integrar sistemas de atenuación sin la necesidad de drivers adicionales.

Integrate LED strips into your exterior designs and redesign your spaces, with the possibility of integrating dimming systems without the need for additional drivers.



IP44



IP65

APLICACIONES / APPLICATIONS



Código Sku	Potencia/ m Power/m (W)	Flujo Luminoso Luminous Flux (lm/m)	Temp. Color Color Temp. (K)	Protección Protection	Vida Útil Life (h)	Uso Use	Longitud Length	Dimensiones Dimensions (mm)	Unidades por Caja Units per box
88217	7	260	● 2200	IP44	10 000	Exterior	5 m	5050 x 10 x 7	12
88232	7	300	● 2700	IP44	10 000	Exterior	5 m	5050 x 10 x 7	12
88234	7	300	● 6500	IP44	10 000	Exterior	5 m	5050 x 10 x 7	12
88233	7	260	● 2200	IP44	10 000	Exterior	25 m	25050 x 10 x 7	2
88218	7	300	● 2700	IP44	10 000	Exterior	25 m	25050 x 10 x 7	2
88235	7	300	● 6500	IP44	10 000	Exterior	25 m	25050 x 10 x 7	2
80017	9	550	● 2700	IP65	6 000	Exterior	25 m	25000 x 18 x 8	2
80018	9	550	○ 4000	IP65	6 000	Exterior	25 m	25000 x 18 x 8	2



ACCESORIOS ECOFLEX 127V

Facilita tu instalación con los accesorios de ECOFLEX 127V y realiza los cortes adecuados de acuerdo a las necesidades de tu diseño de Iluminación.

Make it easy to install with ECOFLEX 127V accessories and make the appropriate cuts according to the needs of your lighting design.



80562



80563



80564



80125



80127



80128



80565



80566



80129



80130

7W/m		
Código Sku	Uso Use	Unidades por Caja Units per box
80562	Exterior	250
80563	Exterior	50
80564	Exterior	70
80565	Exterior	20
80566	Exterior	120

9W/m		
Código Sku	Uso Use	Unidades por Caja Units per box
80125	Exterior	50
80127	Exterior	15
80128	Exterior	150
80129	Exterior	100
80130	Exterior	50



TIRAS LED PRIMEFLEX 24V

Estas tiras cuentan con las características adecuadas para el mercado de proyectos profesionales que buscan soluciones de alto rendimiento y vida útil con el fin de brindar los mayores beneficios en sistemas de iluminación general en espacios comerciales y de oficinas.

These strips have the appropriate characteristics for the professional project market that seek high performance and long life solutions in order to provide the greatest benefits in general lighting systems in commercial and office spaces.



APLICACIONES / APPLICATIONS



Código Sku	Potencia/ m Power/m (W)	Flujo Luminoso Luminous Flux (lm/m)	Temp. Color Color Temp. (K)	Protección Protection	Vida Útil Life (h)	Uso Use	Dimensiones Dimensions (mm)	Unidades por Caja Units per box
80001	9.6	1 170	● 2700	IP20	50 000	Interior	5000 x 10 x 1.6	10
80002	9.6	1 300	○ 4000	IP20	50 000	Interior	5000 x 10 x 1.6	10
80003	12	1 500	● 2700	IP20	50 000	Interior	5000 x 10 x 1.6	10
80004	12	1 650	○ 4000	IP20	50 000	Interior	5000 x 10 x 1.6	10
80005	16.8	2 150	● 2700	IP20	50 000	Interior	5000 x 10 x 1.6	10
80006	16.8	2 350	○ 4000	IP20	50 000	Interior	5000 x 10 x 1.6	10
80007	19.2	2 400	● 2700	IP20	50 000	Interior	4553 x 10 x 1.6	10
80008	19.2	2 600	○ 4000	IP20	50 000	Interior	4553 x 10 x 1.6	10

DRIVERS PRIMEFLEX 24V

Complementa tus proyectos de iluminación con tiras LED, adicionando drivers de aplicación interior o exterior que energicen adecuadamente tus tiras LED PRIMEFLEX 24V. Además cuentan con la posibilidad de integrar sistemas de atenuación 0-10V.

Complement your lighting projects with LED strips, adding drivers for interior or exterior application that adequately energize your PRIMEFLEX 24V LED strips. They also have the possibility of integrating 0-10V attenuation systems.



Código Sku	Potencia Power (W)	Parámetros de salida Output parameters		Protección Protection	Uso Use	Dimensiones Dimensions	Ideal para tiras Ideal for strips	Atenuable Dimmable	Unidades por Caja Units per box
		Tensión (V)	Corriente (A)						
80039	100	24 V	4.1	IP20	Interior	250 × 58 × 38	80001, 80002, 80003, 80004, 80005, 80006, 80007, 80008	No	20
80041	100	24 V	4.1	IP20	Interior	250 × 58 × 38	80001, 80002, 80003, 80004, 80005, 80006, 80007, 80008	0 - 10 V	20
80040	100	24 V	4.1	IP67	Exterior	233 × 74 × 42.2	80009, 80010, 80011, 80012, 80013, 80014, 80015, 80016	No	10
80042	100	24 V	4.1	IP67	Exterior	233 × 74 × 42.2	80009, 80010, 80011, 80012, 80013, 80014, 80015, 80016	0 - 10 V	10

ACCESORIOS PRIMEFLEX 24V

Aumenta las posibilidades de instalación y diversifica tus diseños integrando conectores de fácil conexión: I, L, T y X.

Increase the installation possibilities and diversify your designs by integrating easy connection connectors: I, L, T and X.



Código Sku	Descripción Description	Protección Protection	Unidades por Caja Units per box
80358	Conector I 10mm	IP20	20
80359	Conector L 10mm	IP20	20
80360	Conector T 10mm	IP20	20
80361	Conector X 10mm	IP20	20



DRIVERS CS

Adecua tus diseños, rehabilita y obtén el mejor rendimiento de tus equipos de iluminación con la nueva línea de drivers de corriente seleccionable, su diseño se adecua a múltiples requerimientos eléctricos ante luminarias de antigua y última generación de LED, ya que cuenta con 6 salidas de corriente predeterminadas, por lo tanto no es necesario contar con equipos sofisticados programables.

Adapt your designs, rehabilitate and obtain the best performance of your lighting equipment with the new line of selectable current drivers, its design adapts to multiple electrical requirements for old and latest generation LED luminaires, since it has 6 outputs predetermined current, therefore it is not necessary to have sophisticated programmable equipment.



CORRIENTE SELECCIONABLE

PROTECCIÓN CONTRA SOBRETENSIONES
2kV

TENSIÓN DE ENTRADA
100 - 277 V~

TENSIÓN DE SALIDA
24 - 46 V

5
AÑOS DE GARANTÍA

Código Sku	Potencia Power (W)	Parámetros de salida Output parameters		Protección Protection	Uso Use	Dimensiones Dimensions	Atenuable Dimmable	Unidades por Caja Units per box
		Tensión (V)	Corriente (mA)					
89517	23	24 - 46 V	250/300/350/400/450/500	IP20	Interior	118.5 x 40 x 30	No	20
89518	40	24 - 46 V	550/600/650/700/750/800/850	IP20	Interior	118.5 x 40 x 30	No	20
89519	55	24 - 46 V	950/1000/1050/1100/1150/1200	IP20	Interior	118.5 x 40 x 30	No	20



SENSORES DE MOVIMIENTO DE USO INTERIOR Y EXTERIOR

Complementa tus equipos de iluminación adicionando sensores de movimiento, los cuales emplean ondas de radar o energía infrarroja para reconocer posibles cambios en las áreas donde se encuentran instalados.

Obtén grandes ahorros de energía, esto debido a que la luz permanece encendida sólo en aquellas estancias que están ocupadas y se apaga cuando no se detecta presencia en la zona, incluso ajusta su configuración para lograrlo automáticamente al detectarse un nivel menor de luz.

Olvídate de los apagadores y disfruta de estos beneficios.

Automate your lighting equipment by adding motion sensors, which use radar waves or infrared energy to recognize possible changes in the areas where they are installed.

Get great energy savings, this because the light remains on only in those rooms that are occupied and turns off when no presence is detected in the area, it even adjusts its settings to achieve it automatically when a lower level of light is detected.

Forget about the dampers and enjoy these benefits.



85196



85197



85198



85199



85200



85202



85203

APLICACIONES / APPLICATIONS



Oficinas



Salas de juntas



Baños



Salas



Estacionamientos



Áreas exteriores



Accesos



Fachadas

Código Sku	Tecnología Technology	Tipo de Instalación Type of Installation	Uso Use	Protección Protection	Ángulo de Detección Detection Angle	Altura de Montaje Mounting Height	Carga Max. LED/ Fluorescente (W) Maximum LED charge / Fluorescent (W) 127 V / 220 V / 277 V	Carga Max. Halógena / Incandescente (W) Maximum Halogen charge / Incandescent (W) 127 V / 220 V / 277 V	Unidades por Caja Units per box
85196	Infrarrojo	Sobreponer	Interior	IP20	360°	2.2 - 4 m	200 W / 300 W /300 W	800 W / 1 000 W / 1 200 W	24
85197	Infrarrojo	Empotrar	Interior	IP20	360°	2.2 - 4 m	200 W / 300 W /300 W	800 W / 1 000 W / 1 200 W	50
85198	Microondas	Empotrar	Interior	IP20	360°	2.2 - 4 m	200 W / 300 W /300 W	800 W / 1 000 W / 1 200 W	50
85199	Microondas	Empotrar	Interior	IP20	360°	1.5 - 3.5 m	200 W / 300 W /300 W	800 W / 1 000 W / 1 200 W	50
85200	Infrarrojo	Empotrar	Interior	IP20	120°	1 - 1.8 m	200 W / 300 W /300 W	800 W / 1 000 W / 1 200 W	100
85202	Infrarrojo	Sobreponer	Exterior	IP44	180°	1.8 - 2.5 m	200 W / 300 W /300 W	800 W / 1 000 W / 1 200 W	50
85203	Infrarrojo	Sobreponer	Exterior	IP44	180°	1.8 - 2.5 m	200 W / 300 W /300 W	800 W / 1 000 W / 1 200 W	50



SENSORES DE MOVIMIENTO DE USO EXTERIOR INDUSTRIAL

Automatiza tus equipos industriales de iluminación adicionando sensores de movimiento con ondas de radar para reconocer posibles cambios en las áreas de trabajo donde se encuentran instalados.

Garantiza la seguridad de los usuarios y genera grandes ahorros de energía simultáneamente, gracias a la versatilidad de este sensor podrás atenuar tus sistemas de iluminación en tres niveles: 75%, 50% y 25% en caso de no detectar presencia, por lo que podrás asegurar el correcto funcionamiento y cuidado de tus equipos, crea configuraciones personalizadas de acuerdo a las necesidades que se requieran cómodamente desde el control remoto incluido.

Automate your industrial lighting equipment by adding motion sensors with radar waves to recognize possible changes in the work areas where they are installed.

It guarantees the safety of the users and generates great energy savings simultaneously, thanks to the versatility of this sensor you can dim your lighting systems in three levels: 75%, 50% and 25% in case of not detecting presence, so you can ensure the correct operation and care of your equipment, create personalized configurations according to the needs that are comfortably required from the included remote control.

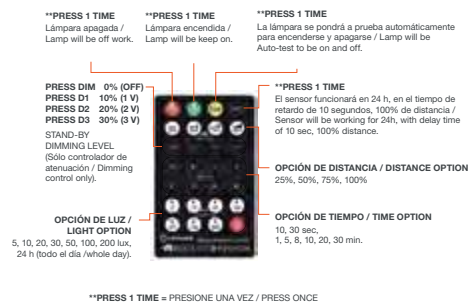

**PRESS 1 TIME = PRESIONE UNA VEZ / PRESS ONCE

- 3**
AÑOS DE GARANTÍA
- 120 - 277 V~**
- 0 10 V**
ATENUABLE
- CONTROL REMOTO INCLUIDO**

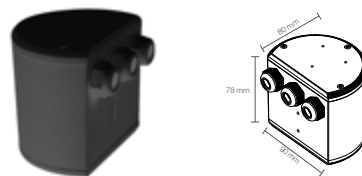

APLICACIONES / APPLICATIONS



Código Sku	Tecnología Technology	Tipo de Instalación Type of Installation	Uso Use	Protección Protection	Ángulo de detección Detection Angle	Altura de Montaje Mounting Height (m)	Atenuación Dimming	Carga máxima LED/Fluorescente (W) Maximum LED load / Fluorescent (W)	Carga máxima Halógena / Incandescente (W) Maximum Halogen load / Incandescent (W)
80447	Microondas	Sobreponer	Exterior	IP65	360°	4 - 15 m	0 - 10V	500W / 1 000W / 1 000 W	1 000W / 2 000W / 2 000 W
								80449	Montaje para techo
								80450	Montaje tipo bisagra

* Se venden por separado / They are sold separately.



FOTOCELDA

Este accesorio permite cortar el paso de la energía eléctrica cuando hay una determinada incidencia de luz logrando realizar un control automático de encendido y/o apagado de los sistemas de iluminación con bajos costos de mantenimiento.

This accessory allows to cut the passage of electrical energy when there is a certain incidence of light, achieving an automatic control of on and / or off lighting systems with low maintenance costs.



3
AÑOS DE GARANTÍA

120 - 277 V~

3
PINES

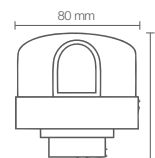

APLICACIONES / APPLICATIONS

- 
 Áreas públicas
Public areas
- 
 Entradas principales
Main entries
- 
 Estacionamientos
Parking lots
- 
 Carreteras
Highways

Código Sku	Uso Use	Protección Protection	Nivel de iluminación de ambiente Light ambient	Unidades por Caja Units per box
85204	Exterior	IP44	<15 LUXES	24



SISTEMAS DE EMERGENCIA

Selecciona el sistema adecuado de acuerdo a la capacidad de los equipos de iluminación y garantiza la seguridad de los usuarios cuando exista un corte en el suministro de energía por hasta 90 minutos.

Select the appropriate system according to the capacity of the lighting equipment and guarantee the safety of users when there is a power outage for up to 90 minutes.

120 - 277 V~

90 min
RESPALDO
MODO
EMERGENCIA

CARGA
DE BATERÍA
EN 24h



Interruptor de prueba
LED indicador de carga



80023



80024



80021



80022

APLICACIONES / APPLICATIONS



Establecimientos
Shops



Oficinas
Offices



Pasillos
Corridors

Código SKU	Potencia Power (W)	Tensión de salida Output Voltage (V)	Corriente de salida Output Current (mA)	Unidades por Caja Units per box
80021	4	10 - 60 V	50 - 500 mA	30
80022	8	15 - 52 V	130 - 540 mA	24
80023	8	15 - 52 V	200 - 750 mA	15
80024	12	15 - 55 V	240 - 480 mA	15

* La iluminación en modo emergencia de la luminaria dependerá de la capacidad del driver seleccionado / The light in emergency mode of the luminaire will depend on the capacity of the selected driver.



SISTEMAS DE CONTROL INALÁMBRICO

Sistema modular inalámbrico compatible con plataformas iOS y ANDROID que permite interconectar hasta 250 dispositivos por red por medio de comunicación vía Bluetooth.

Dentro de sus principales ventajas tenemos:

Wireless modular system compatible with iOS and ANDROID platforms that allows up to 250 devices to be interconnected per network through communication via Bluetooth.

Among its main advantages we have:



Control individual o grupal



Crear escenas



Control de blanco dinámico



Control con sensor de presencia



Control con sensor de luz



Animaciones



Control ajustable de acuerdo a la luz natural



Compatible con iOS y Android



Funcionalidad de ciclo circadiano



Atenuable



Control de colores RGB

GATEWAY BLE

Esta unidad central de control permite crear grupos de hasta 250 equipos interconectados entre si por unidad, con el fin de tener una gestión de los sistemas de control mucho más ordenadas y de acuerdo a las necesidades y requerimientos de cada espacio.

Además de ser la puerta de enlace hacia la nube donde podrá realizar cualquier configuración adicional en tiempo real.

Cuenta con dos protocolos de conexión a internet como son: Ethernet y Wi-Fi para poder ser conectado a una red local o residencial con cualquiera de éstas dos vías de comunicación.

This central control unit allows creating groups of up to 250 interconnected devices per unit, in order to have a much more orderly management of the control systems and according to the needs and requirements of each space.

In addition to being the gateway to the cloud where you can perform any additional configuration in real time.

It has two internet connection protocols such as: Ethernet and Wi-Fi to be able to be connected to a local network or residential area with either of these two communication routes.



Código Sku	Conectividad Connectivity	Salida de Video Video Output	Sistema Operativo Operating System	Unidades por Caja Units per box
80862	Ethernet / Wi-Fi / Bluetooth	HDMI 1.3	Android	20

CONTROL DE PARED BLE

Xpress es un control inalámbrico Bluetooth que se conecta al sistema de control para regular la intensidad de la iluminación, gestionar el encendido y apagado de equipos individuales, grupos y escenas previamente seleccionados en la aplicación.

Para mayor información y configuraciones consultar la ficha técnica.

Xpress is a bluetooth wireless controller that connects to the control system to regulate the intensity of the lighting, manage the on and off of individual equipment, groups and scenes previously selected in the application.

For more information and configurations consult the technical sheet.



Código Sku	Conectividad Connectivity	Alcance Range	Unidades por Caja Units per box
80861	Bluetooth	60 m	20

SENSOR BLE

Sensor infrarrojo que brinda amplios beneficios como el ahorro de energía mientras no se esté ocupando las áreas iluminadas, además de incluir un sensor de incidencia de luz con beneficios como la autorregulación de los equipos de iluminación de acuerdo a la incidencia de luz natural.

Sensor BLE provides extensive benefits such as energy savings while not occupying illuminated areas, in addition to including a light incidence sensor with benefits such as self-regulation of lighting equipment according to the incidence of natural light.



Código Sku	Conectividad Connectivity	Tecnología Technology	Tipo de Instalación Type of Installation	Uso Use	Protección Protection	Ángulo de Detección Detection Angle	Altura de Montaje Mounting Height	Unidades por Caja Units per box
80863	Bluetooth	Infrarrojo	Empotrar	Interior	IP20	53°	2.2 - 4 m	24

RELEVADORES BLE

Relevador que permite el control de cargas conectadas a este dispositivo y adiciona una comunicación 0-10V para un excelente control de equipos de iluminación.

Relay that allows the control of loads connected to this device and adds a 0-10V communication for an excellent control of lighting equipment.



Código Sku	Conectividad Connectivity	Carga Máxima Maximum Load	Salida de Control Control Output	Unidades por Caja Units per box
80865	Bluetooth	10 A	NA	25
80866	Bluetooth	2 A	0 -10V DC	25



LEDVANCE® SMART+ LIGHTING

Con la tecnología SMART+ de LEDVANCE, podrás transformar tu hogar en un mundo de experiencias creativas y dinámicas, creando escenas, grupos y programaciones acogedoras y versátiles.

With LEDVANCE's SMART+ technology, you can transform your home into a world of creative and dynamic experiences, creating welcoming and versatile scenes, groups and schedules.



DOWNLIGHT
88744



CEILING
88745



TIRA LED
88746



APLICACIONES / APPLICATIONS

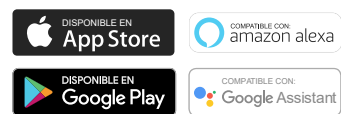

Código Sku	Potencia Power (W)	Equivalencia Equivalence CFLI (W)	Flujo Luminoso Luminous Flux (lm)	Ángulo de Apertura Opening Angle	Temp. de Color Color Temp. (K)	Vida Útil Life (h)	IRC CRI	Dimensiones Dimensions (mm)	Color de Producto Product Color	Unidades por Caja Units per box
88744	15	2 x 15	1 200	110°	RGBW	15 000	>80	Ø 165 x 48	Blanco	12
88745	22	2 x 23	1 800	110°	RGBW	15 000	>80	Ø 280 x 55	Blanco	10
88746	4.25 W/m	NA	380 lm/m	120°	RGBW	15 000	>80	2000 x 20 x 2.8	Blanco	12

Accesorios*
Accessories* 88798 Extensión de Tira 2 Metros

* Se venden por separado / They are sold separately.

* En sustitución de lámparas CFLI compactas / In the replacement of compact CFLI lamps.



LEDVANCE® SMART+ FLOOR CORNER

Crea la atmósfera perfecta en tus espacios personalizando tu iluminación con diferentes tonalidades de luz blanca (TW) y luz multicolor (RGB), con un solo toque o comando de voz.

Todo el control en la palma de tu mano:

- Crea escenas y animaciones
- Programa horarios de encendido y apagado
- Crea esquemas de iluminación circadiana (cambia la temperatura de color acorde a la luz natural)

Create the perfect atmosphere in your spaces by customizing your lighting with different shades of white light (TW) and multicolored light (RGB), with a single touch or voice command.

All control in the palm of your hand:

- Create scenes and animations
- Schedule on and off times
- Create circadian lighting schemes (change color temperature according to light natural)

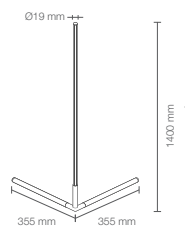

APLICACIONES / APPLICATIONS



Código Sku	Potencia Power (W)	Flujo Luminoso Luminous Flux (lm)	Ángulo de Apertura Opening Angle	Temp. de Color Color Temp. (K)	Vida Útil Life (h)	IRC CRI	Dimensiones Dimensions (mm)	Color de Producto Product Color	Unidades por Caja Units per box
85228	14	200	108°	RGBW	30 000	>80	1400 x 355 x 355	Negro	12



LEDVANCE® SMART+ DESIGN PLAFON

Nunca había sido tan fácil crear experiencias personalizadas desde la palma de tu mano, implementa iluminación general e incluso decorativa al mismo tiempo que brindas a tus espacios un estilo sofisticado y moderno, todo con tan solo un toque o un comando de voz. Asistentes de voz compatibles: Google Assistant, Amazon Alexa o Siri.

Now is very easy to create personalized experiences from the palm of your hand, implement general and even decorative lighting while giving your spaces a sophisticated and modern style, all with just a touch or a voice command. Compatible voice assistants: Google Assistant, Amazon Alexa or Siri.

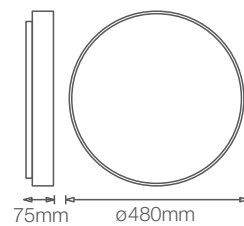

APLICACIONES / APPLICATIONS



Código Sku	Potencia Power (W)	Flujo Luminoso Luminous Flux (lm)	Ángulo de Apertura Opening Angle	Temp. de Color Color Temp. (K)	Vida Útil Life (h)	IRC CRI	Dimensiones Dimensions (mm)	Color de Producto Product Color	Unidades por Caja Units per box
89181	32	2 450	120°	RGBW	30 000	>80	Ø 480 x 75	Negro	4
89182	32	2 650	120°	RGBW	30 000	>80	Ø 480 x 75	Blanco	4



LEDVANCE® SMART+ CEILING DECO

El nuevo CEILING DECO SMART+ WIFI lo tiene todo: diseño decorativo, garantía de calidad LEDVANCE y tecnología inteligente. Hay 16 millones de posibilidades de color, además del blanco dinámico (que van desde 2700K a 6500K). Con solo un toque en su teléfono o tableta puede: atenuar, cambiar de color, alternar y atenuar luminarias individualmente o en grupos, crear escenas y animaciones, establecer temporizadores, crear esquemas de iluminación circadianos y espectáculos de luces dinámicos.

The new CEILING DECO SMART+ WIFI has it all: decorative design, LEDVANCE quality guarantee and smart technology. There are 16 million color possibilities in addition to dynamic white (ranging from 2700K to 6500K). With just one tap on your smartphone or tablet, you can: attenuate, change color, toggle and dim fixtures individually or in groups, create scenes and animations, set timers, create circadian lighting schemes and dynamic light shows.

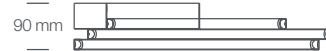
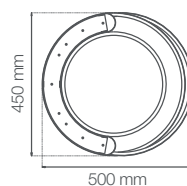

APLICACIONES / APPLICATIONS



Código Sku	Potencia Power (W)	Flujo Luminoso Luminous Flux (lm)	Ángulo de Apertura Opening Angle	Temp. de Color Color Temp. (K)	Vida Útil Life (h)	IRC CRI	Dimensiones Dimensions (mm)	Color de Producto Product Color	Unidades por Caja Units per box
89393	27	1 450	220°	RGBW	50 000	>80	Ø 450 x 90	Negro	2
89394	27	1 850	220°	RGBW	50 000	>80	Ø 450 x 90	Blanco	2



LEDVANCE® SMART+ SUSPENDING DECO

Una novedad más en nuestro portafolio LEDVANCE SMART+ WIFI para tus proyectos. Una luminaria colgante que cuenta con diseño moderno y con el toque de la tecnología inteligente con el que podrás ajustar la temperatura de color variando desde 2 700 K a 6 500K, atenuar la iluminación a tu gusto, controlar por medio de comandos de voz y ¡mucho más!

One more novelty in our LEDVANCE SMART+ WIFI portfolio for your projects. A pendant lamp that has a modern design and with the touch of smart technology with which you can adjust the color temperature ranging from 2,700 K to 6,500 K, dim the lighting to your liking, control through voice commands and! much more!

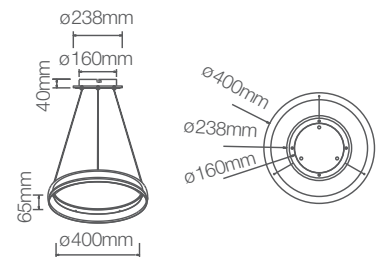

APLICACIONES / APPLICATIONS

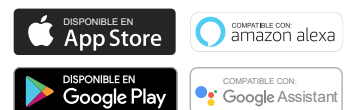

Código Sku	Potencia Power (W)	Flujo Luminoso Luminous Flux (lm)	Ángulo de Apertura Opening Angle	Temp. de Color Color Temp. (K)	Vida Útil Life (h)	IRC CRI	Dimensiones Dimensions (mm)	Color de Producto Product Color	Unidades por Caja Units per box
89397	30	2 470	120	TW	50 000	>80	Ø 400 x 65	Blanco	3

ACERCA DE LEDVANCE

Con oficinas en más de 50 países y actividades comerciales en más de 140 países, LEDVANCE es uno de los principales proveedores de iluminación general del mundo para usuarios profesionales y consumidores finales. Tras emerger del negocio de iluminación general de OSRAM GmbH, LEDVANCE ofrece una amplia gama de luminarias LED para una gran variedad de usos en áreas de aplicación, productos de iluminación inteligente para hogares y edificios inteligentes, una de las carteras de lámparas LED más grandes de la industria, así como también fuentes de luz tradicionales.

LEDVANCE, S.A. DE C.V.
Camino a Tepalcapa No.8
Col. San Martín Tultitlán,
Tultitlán, Estado de México, México, CP 54900
01 800 716 7007 (interior de la República)
5899 1807 (CDMX y Área Metropolitana)

Síguenos en redes sociales



¡Visita nuestro landing page!

 <https://expertosdelaluz.com/>



Licencia de producto de marca OSRAM
para lámparas en iluminación general