



**JamesHardie®**

<b>Introducing James Hardie</b>	4
<b>Why fibre cement?</b>	6
<b>HardiePlank® weatherboard</b>	10
<b>HardiePanel® weatherboard</b>	22
<b>HardieLinea® weatherboard</b>	34
<b>James Hardie® trims</b>	42
<b>ColourPlus™ Technology</b>	44
<b>HardieBacker® tile backerboard</b>	52
<b>Technical information</b>	58



“Today’s customers want uniquely designed homes made from durable and low maintenance building materials. James Hardie® products offer a perfect solution.”

---

John Tee, Architect

**We believe a beautiful house is the combination of select materials and smart construction techniques blended to create a stunning aesthetic.**

Fibre cement is a robust composite material, engineered to create durable, dependable products. As a result, our wide range of building solutions stay as timeless, strong and weather-resistant as when they were first applied.



**High performance,  
inside and out**

James Hardie® products are designed to stay as beautiful, strong and weather resistant as when your project was built. Our secret for everlasting youth? The James Hardie fibre cement formulation: an invention that's allowed us to make the most durable fibre cement products on the market.

As the pioneers of seventh generation fibre cement, our unmatched technological innovation makes our products generations ahead of competitors in performance and appearance, delivering ultimate peace of mind.



**James Hardie,  
the pioneers of  
seventh generation  
fibre cement**



**Standing strong for  
years to come**

The superior characteristics of our fibre cement products make them the preferred, low maintenance choice of professional builders, architects and homeowners alike. James Hardie® fibre cement is thinner and lighter-weight, yet stronger and easier to handle than most alternative building materials, ensuring your build moves along faster – with less hold ups and complications.

Feel confident in the staying power of your build: our products are non combustible, water resistant and will never rot or warp.



WEATHER  
RESISTANT



EASY TO  
INSTALL



LOW  
MAINTENANCE



FIRE  
RESISTANT

**Tougher  
than nature,  
made to last**





**HardiePlank®**



HardiePlank® Weatherboard  
Cedar Texture, Cobble Stone





# Introducing HardiePlank®

**HardiePlank® Weatherboard**  
Cedar Texture, open joint Installation in Boothbay Blue

**HardiePlank®** HardiePlank® cladding is a versatile, low maintenance weatherboard that is stronger than the elements. Installation is quick and easy, offering maximum flexibility with options to fit our boards horizontally, vertically, ship-lapped or open jointed. Available in 21 colours and two textures, the product's clean lines and outstanding performance stand the test of time and nature's harshest scrutiny.



“We looked at all the options,  
including HardiePlank®, and for us  
it was an easy decision; quick to  
install, cost effective and beautiful.  
It just looks and feels perfect.”

---

Bill Jenkins, homeowner

HardiePlank® Weatherboard  
Cedar Texture, Soft Green







“The more people see and hear about James Hardie, the more they fall in love. HardiePlank® is universal in its appeal.”

---

Gary Stevens, Fabulous Fascia Company

**HardiePlank® Weatherboard**  
Cedar Texture, Midnight Black





"This is a sustainable and marvelous substitute for wood. It's pre-coloured and the finish truly looks like high grade wood cladding. I've used this product for years and have been delighted with the results."

Sarah Susanka, Designer



HardiePlank® Weatherboard  
Cedar Texture, Monterey Taupe





"Words cannot describe how  
HardiePlank® has changed my  
home. Our house looks great and  
is a lot more maintenance free  
- no more painting and scraping."

Jim Cornett, homeowner

HardiePlank® Weatherboard  
Cedar Texture, Light Mist





**HardiePanel**<sup>®</sup>

 **JamesHardie**<sup>®</sup>

**HardiePanel<sup>®</sup> Weatherboard**  
Smooth Texture, bespoke colour



**HardiePanel®** 'at a glance' The robust, non combustible, large format facade board engineered to leave a lasting impression. HardiePanel® cladding is available in a range of 21 colours and a choice of three textures - making it a smart solution for any project.

With clean, crisp lines perfectly suited to large-scale renovations and new builds, our unique ColourPlus™ Technology formulation and 10 year warranty ensure it retains an immaculate appearance for years to come. Alternatively, our PrimePlus™ finish offers endless flexibility to create bespoke colour choices on every design.



## Introducing HardiePanel®

**HardiePanel® Weatherboard**  
Smooth Texture, mixed colours



“Choosing to use James Hardie® facade products was an important decision for us, we needed materials that would stand the test of time.”

Kam MacRory, Berkeley Homes



**HardiePanel® Weatherboard**  
Smooth Texture, Arctic White



“HardiePanel® helped us to deliver our unique architectural vision. A great solution which provided design flexibility with durability.”

Mr Demeulemeestar, Nexity

© Stephane Chaireau

**HardiePanel® Weatherboard**  
Smooth Texture, mixed colours



"We use James Hardie® for many reasons; quality, durability, cost effectiveness and architectural design."

Gregg McGaha, Morrison Homes



**HardiePanel® Weatherboard**  
Smooth Texture, Arctic White & Iron Grey



“When you take on board the cost of preparation and maintenance that comes with alternatives, then fibre cement makes a strong competitive case.”

David Tomlinson, Coombs Construction

HardiePanel® Weatherboard  
Smooth Texture, Arctic White



**HardieLine**<sup>®</sup>



HardieLine<sup>®</sup> Weatherboard  
Smooth Texture, Cobble Stone



**HardieLine®** Installed horizontally, HardieLine® premium weatherboard casts stunning deep shadow lines in a selection of 10 colours, delivering the ultimate in both aesthetic beauty and protection against the elements.

With its range of elegant, contemporary colours and powerful graphic lines, HardieLinea cladding creates endless possibilities for architects and homeowners alike. And a factory-applied, ColourPlus™ Technology finish will ensure your facade remains beautiful no matter what the weather presents. Specifically formulated to provide a low maintenance durable exterior, the multi-coat baked-on finish supplies the perfect fade-resistant match for your build.

# Introducing HardieLinea®



**HardieLinea® Weatherboard**  
Smooth Texture, Arctic White



"It's such a deep, chunky board, much less fussy than standard weatherboard, and gives a really clean line and smooth finish that looks very substantial."

Homeowner, Anne Kingdon

HardieLine® Weatherboard  
Smooth Texture, Light Mist





“HardieLinea® is a beautiful product, with all the artistic freedom of real wood cladding, but without the maintenance issues.”

Nick Mortimer, Architect

HardieLinea® Weatherboard  
Smooth Texture, Midnight Black

Copyright Daniel Hundven Clements



# James Hardie® Trims



Trim is that final touch that completes your home's design

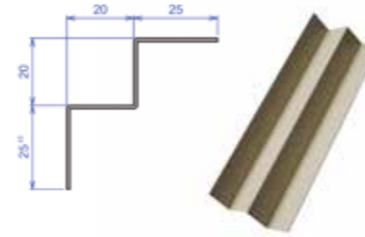

### Metal trims

MetalTrim™ exterior and interior corner trims are manufactured from high-quality coated aluminium and are available in all 21 colours, giving corners a contemporary appearance.

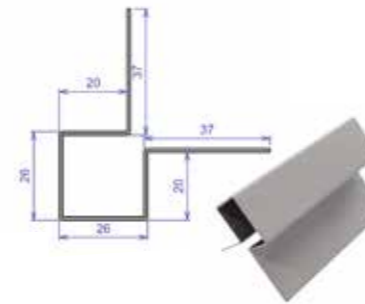

With external corners available for all cladding products, and internal corners available for HardiePlank® and HardiePanel® cladding, you can add a sleek frame to any facade installation.

**Metal Trim**  
Iron Grey

### Fibre cement trims

HardieTrim NT3® trim (25 mm) is the perfect choice for a bold design statement to complement your HardiePlank® cladding.



Accent Trim™ exterior trim (38 mm) offers the perfect, ultra-chunky robust trim for HardieLinea® cladding.



Both our fibre cement trims are 3.655 m in length, and available in Arctic White, Midnight Black & Sail Cloth with a choice of 90 mm or 140 mm widths.





**ColourPlus™  
Technology**

**HardiePanel® Weatherboard**  
Smooth Texture, mixed colours



**ColourPlus™ Technology** Perfected through years of research and development, we created ColourPlus Technology to ensure lasting exterior results on every build.

With a multi-coat, baked-on finish to match your design, the ColourPlus specific formulation is 30% more resistant to UV fade than paint applied on site, minimising maintenance while retaining its timeless, vibrant beauty.

Selected from a palette of classic and contemporary colours, ColourPlus Technology is underpinned by a 10-year warranty which protects against peeling, chipping or cracking.

## Grey Collection

**Pearl Grey**



Elegant white-toned neutral inspired from the softest colours in nature, sand and beach-strewn seashells.

**Grey Slate**

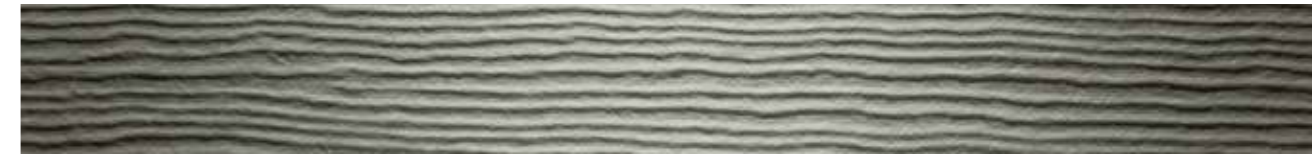

A deep warm grey reminiscent of polished antique silver.

**Iron Grey**



Strong statement slate inspired by London's ornate wrought ironwork.

**Anthracite Grey**



A bold modern grey intensified by blue undertones, perfect for creating strongly defined lines.

**Midnight Black**



Sleek and velvet dark, a bold modern classic to create maximum impact.



### Cool Collection

**Evening Blue**

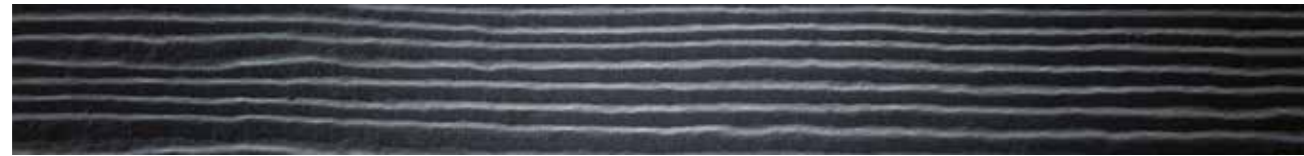

Muted gunmetal blue comes alive next to a creamy neutral.

**Boothbay Blue**



Gorgeous grey-based blue inspired by enduring seascape shades.

**Light Mist**

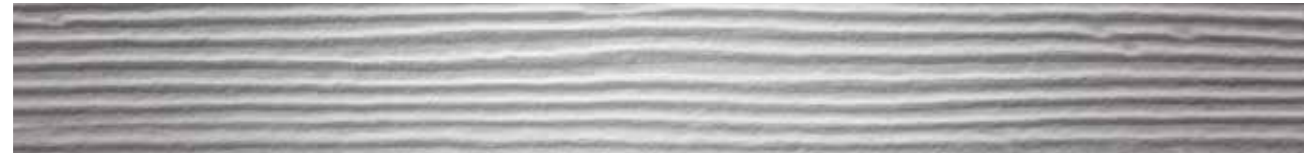

Softly sophisticated, this pale lilac-hued grey evokes classic lines of Kentish beachfront homes.

**Arctic White**



Timeless, snowy neutral with calming, cool grey undertones.

### Warm Collection

**Traditional Red**

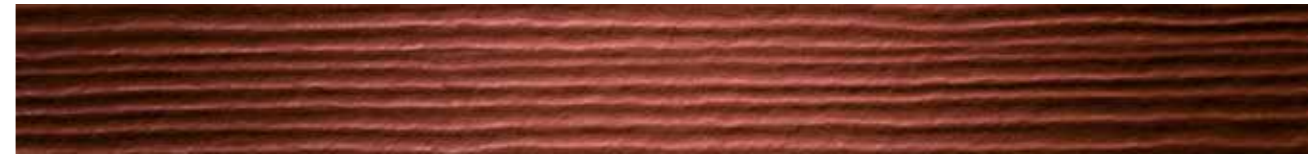

Warm russet and maple tones bring depth to this autumnal red.

**Chestnut Brown**



Charismatic pigmented brown with deep notes of silky chestnut and beautifully aged leather.

**Timber Bark**



Intriguingly dark for powerful definition yet imbued with a natural woody softness.

**Khaki Brown**



Elements of soft natural timber meld with gentle, grey-green hues.



### Neutral Collection

**Rich Espresso**



This classic dark shades subtle brown pigments infuse warmth into a clean grey base.

**Monterey Taupe**



Subtle neutral undertones of oyster and seashell converge for a shade of timeless Oxfordshire stone.

**Cobble Stone**



Contemporary dove-grey neutral with golden undertones.

**Sail Cloth**



Soft hues of undyed linen infused with subtle pearly warmth.

### Fresh Collection

**Mountain Sage**



Moody golden-green infused with muted hues to catch the light.

**Heathered Moss**



Warm and compelling, a softly greying green to evoke Highlands country life.

**Soft Green**



Engaging pastel green shot through with tones of greying skies.

**Woodland Cream**



Luscious milky pastel inspired by delicate springtime petals.





**HardieBacker®**

 **JamesHardie®**





# Introducing HardieBacker®

HardieBacker® Tile Backerboard  
12mm and 6mm

**HardieBacker®** Protect your tiles with HardieBacker® tile backerboard, the UK's number one  
**'at a glance'** engineered tile backerboard for walls and floors.

Renowned for its superior strength, HardieBacker board has a robust and dimensionally stable profile, making a perfect flat tiling surface, while a 10-year guarantee provides lasting peace of mind.

The product's unique cement fibre formulation means boards are impervious to water damage, ensuring outstanding performance on every job. Easy to cut thanks to its score and snap system, HardieBacker board can be fitted fast with zero fuss.



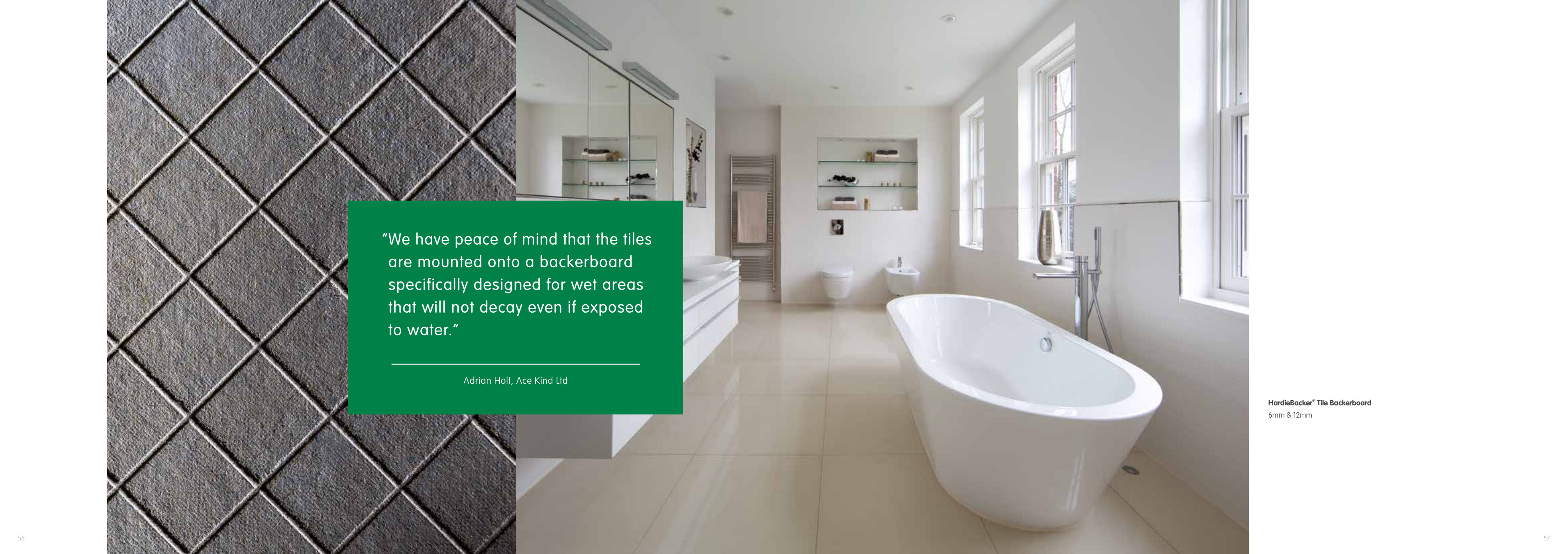

"We have peace of mind that the tiles are mounted onto a backerboard specifically designed for wet areas that will not decay even if exposed to water."

Adrian Holt, Ace Kind Ltd

**HardieBacker® Tile Backerboard**  
6mm & 12mm





## Technical Information

**HardiePanel® Weatherboard**  
Smooth Texture, bespoke colour



## HardiePlank® Technical Information

### Textures:



Smooth



Cedar

### Trims:



MetalTrim™  
External Corner Trim

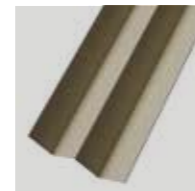

MetalTrim™  
Internal Corner Trim



HardieTrim NT3®  
Trim

### Composition:

Portland cement, sand, cellulose fibre, water, selected additives.

### Properties:

HardieZone® Technology for advanced climate protection & ColourPlus™ Technology, formulated for superior UV resistance & durable finish.

### Dimensions:

3600 x 180 x 8 mm

### Weight:

7.4 kg per plank, 11.419 kg/m<sup>2</sup> (15 kg/m<sup>2</sup> when installed ship-lapped)

### Density:

1300 kg/m<sup>3</sup>

### Fire rating:

A2, s1-d0

### Warranty:

10 years

### Certifications:

CE, BBA, Avis Technique.



### Accessories



Gecko Gauge



HardieGuillotine™



HardieBlade®  
Saw Blade



EPDM Tape



HardieClip™



Starter Strip



Ventilation Profiles



HardieSeal™  
Edge Coating

## HardiePanel® Technical Information

### Textures:



Smooth



Cedar

### Trim:

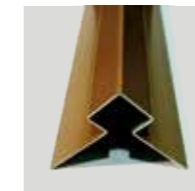

MetalTrim™  
External Corner Trim

### Composition:

Portland cement, sand, cellulose fibre, water, selected additives.

### Properties:

HardieZone® Technology for advanced climate protection & ColorPlus™ Technology, formulated for superior UV resistance & durable finish.

### Dimensions:

3050 x 1220 x 8 mm (2440 x 1220 x 8 mm special order only)

### Weight:

41.7 kg per sheet, 11.2 kg/m<sup>2</sup>

### Density:

1300 kg/m<sup>3</sup>

### Fire rating:

A2, s1-d0

### Warranty:

10 years

### Installation:

No pre-drilling required and the panel sheets can be easily cut to size on site.

### Certifications:

CE, BBA, Avis Technique.



### Accessories



Horizontal Drip Profile



HardiePanel Screws



HardieBlade®  
Saw Blade



EPDM Tape



HardieSeal™  
Edge Coating



## HardieLine® Technical Information

### Textures:

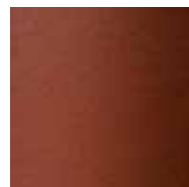

Smooth

### Trims:

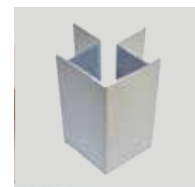

MetalTrim™  
External Corner Trim



MetalTrim™  
Internal Corner Trim



Accent Trims

### Accessories



HardieBlade®  
Saw Blade



EPDM Tape



HardieSeal™  
Edge Coating



Starter Strip



Ventilation Profiles

### Composition:

Portland cement, sand, cellulose fibre, water, selected additives.

### Properties:

HardieZone® Technology for advanced climate protection & ColorPlus™ Technology, formulated for superior UV resistance & durable finish.

### Dimensions:

3655 x 210 x 16mm

### Overlap:

30mm

### Weight:

19.66 kg per plank, 25.61 kg/m²

### Density:

1150 kg/m³

### Fire rating:

A2, s1-d0

### Warranty:

10 years

### Certifications:

CE, BBA, Avis Technique.



## HardieBacker® Technical Information

### Accessories



HardieBlade®  
Saw Blade



HardieBacker®  
Score-and-Snap Knife



HardieBacker®  
Screws for floors



Fibatape

### Composition:

Portland cement, sand, cellulose fibre, water, selective additives.

### Installation:

Use on walls or floors with all types of ceramic or stone tiles thanks to excellent tile adhesion properties.

### Dimensions:

6mm: 1200 x 800 x 6 mm  
12mm: 1200 x 800 x 12 mm

### Weight:

6mm: 9 kg per board  
12mm: 12.8 kg per board

### Strength:

Highest flexibility and up to 3x the compressive strength of competitive boards. Holds up to 100 kg/m²

### Fire rating:

A1

### Warranty:

10 years

### Certifications:

CE and BBA approved with certificate no. 04/4100.  
The product meets the EN 1246 standard.





