

## Installation Instructions

# HardiePlank® Product Family





# Contents

---

01 General Information	p. 4	<b>1</b>
<hr/>		
02 Technical Attributes	p. 6	<b>2</b>
<hr/>		
04 Trims, Tools and Accessories	p. 11	<b>3</b>
<hr/>		
04 Storage & Handling	p. 16	<b>4</b>
<hr/>		
05 General Fixing Information	p. 18	<b>5</b>
<hr/>		
06 Horizontal Installation HardiePlank® weatherboards (overlap)	p. 28	<b>6</b>
<hr/>		
07 Vertical Installation HardiePlank® weatherboards (hit and miss)	p. 44	<b>7</b>
<hr/>		
08 Horizontal Installation HardiePlank® VL weatherboards	p. 50	<b>8</b>
<hr/>		
09 Vertical Installation HardiePlank® VL weatherboards	p. 61	<b>9</b>
<hr/>		
10 Maintenance	p. 65	<b>10</b>
<hr/>		

# 01 General Information

1

## HardiePlank® Family Overview

If you're looking for a versatile, low maintenance weatherboard with a natural and beautiful texture, look no further than our fibre cement HardiePlank® product family. It's the facade of choice for builders and homeowners alike, protecting and beautifying millions of homes.

Made from advanced material fibre cement, HardiePlank® weatherboard is an engineered cellulose-fibre and cement composite that offers the ultimate in fire, moisture, rot and pest resistance. The board's unique properties offer major advantages over conventional cladding materials, providing ease of installation, design flexibility and enhanced durability.

## Why use HardiePlank® weatherboard?

### **Made to last**

With advanced seventh generation technology we've created the most durable HardiePlank® weatherboard ever made, with enhanced properties for unmatched durability. Our additives are chemically bonded to provide lasting resistance to rain, hail, wind, fire, rot and pests.

### **Best of both strength and usability**

We've found the perfect balance between high-quality Portland cement, sand and cellulose fibre to deliver lightweight, easy-to-cut weatherboard that installs firm and fast.

### **Superior dimensional stability**

Our weatherboard is engineered at the microscopic level to create a robust fibre cement composite that doesn't shrink or split.

### **Ultimate design flexibility**

Available in an array of colours with James Hardie ColourPlus™ Technology, and two textures, for the ultimate design flexibility.

## Benefits

+ Most **natural look** according to 90% of homeowners<sup>1</sup>

+ Low maintenance thanks to unique **ColourPlus™ Technology**<sup>2</sup>

+ Up to **20% faster** installation<sup>3</sup>

<sup>1</sup> Based on feedback of more than 800 respondents

<sup>2</sup> Our ColourPlus™ Technology finishes have been evaluated in tests simulating decades of UV exposure and show exceptional resistance to colour change

<sup>3</sup> Based on side to side installation with comparable systems

## Warranty Information

Use James Hardie® fibre cement products with confidence, in the knowledge that you're choosing the best. All our fibre cement products have a 15 year warranty and have an anticipated life expectancy of 60 years.

This includes all our exterior facade products with baked on ColourPlus™ Technology finishing, in addition to our interior building solutions.

For our products, customers can rest assured there will be:

- No warping, cracking or peeling
- No rotting
- No damage from adverse weather conditions

For further information, please visit; [jameshardie.co.uk](http://jameshardie.co.uk)



### BBA Certified

JamesHardie® weatherboard has been assessed by the British board of Agreement and has been awarded BBA certificate number 04/4147.

## 02 Technical Attributes

### HardiePlank® weatherboard

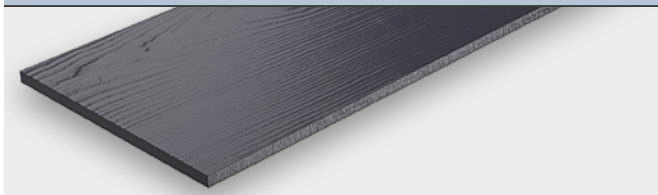

<b>Thickness</b>	8 mm
<b>Length</b>	3 600 mm
<b>Width</b>	180 mm
<b>Coverage</b>	0.54 m <sup>2</sup> with 30 mm lap (Approx 2 planks per m <sup>2</sup> ) 0.65 m <sup>2</sup> with full board
<b>Weight per piece</b>	7.4 kg
<b>Weight per surface area</b>	11.2 kg/m <sup>2</sup>
<b>Raw density</b>	1 300 kg/m <sup>3</sup>
<b>Material class (EN 13501-1)</b>	Non-combustible, A2-s1,d0
<b>Tensile strength</b>	After storage, dry > 10 MPa After storage, wet > 7 MPa
<b>Relative linear expansion, 30–90 % rel. air humidity</b>	≤ 0.05 %
<b>Category and Class acc. to EN 12467</b>	Category A, Class 2
<b>Thermal conductivity</b>	$\lambda_{10, tr} = 0.23 \text{ W/mK}$
<b>Heat transfer resistance</b>	$R_{10, tr} = 0.035 \text{ (m}^2\text{K)/W}$

### Wind Load Table

Type of sub-structure	Batten separation [mm]	Type of fixings/ Dimensions [mm]	Max. Wind-load [kPa]
Timber Battens min. 25×50 mm	400/600	2.8×51×6.5 D-head nails, Paslode	1.87/1.33
	600	2.8×32×7 round head nails, eg. Paslode (IM45)	1.4
	600	HardieClip™ reinforcement clip with 2.8×51×6.5 D-head nails	2.07
	600	3.0×50×10 round head nails	1.7
	600	4.0×35×8 countersunk head screws	1.4
Steel battens 1.5 mm metal top hat	600	3.5×34×8.75 countersunk head screw, eg. Faynot	2.55
Aluminium rails 2.2 mm	600	3.5×34×8.75 countersunk head screw, eg. Faynot	1.4

## HardiePlank® VL weatherboard

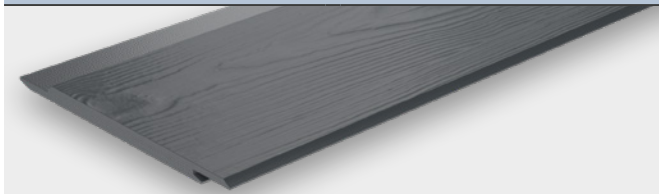

<b>Thickness</b>	11 mm
<b>Length</b>	3 600 mm
<b>Width</b>	214 mm (usable 182 mm)
<b>Coverage</b>	0.66 m <sup>2</sup>
<b>Weight per piece</b>	10.5 kg
<b>Weight per surface area</b>	13.6 kg/m <sup>2</sup>
<b>Raw density</b>	1 300 kg/m <sup>3</sup>
<b>Material class (EN 13501-1)</b>	Non-combustible, A2-s1,d0
<b>Tensile strength</b>	> 15 MPa at right angles to the direction of fibres > 11 MPa parallel to direction of fibres
<b>Relative linear expansion, 30–90 % rel. air humidity</b>	≤ 0.05 %
<b>Category and Class acc. to EN 12467</b>	Category A, Class 2
<b>Thermal conductivity</b>	$\lambda_{10, tr} = 0.23 \text{ W/mK}$
<b>Heat transfer resistance</b>	$R_{10, tr} = 0.048 \text{ (m}^2\text{K)/W}$

## Wind Load Table

Type of sub-structure	Batten separation [mm]	Fixing elements/Dimensions [mm]	Max. Wind-load [kPa]
Timber battens (min. 38 × 50 mm)	400	HardiePlank™ screw T15 Torx stainless steel A2, 4.2 × 40 mm, 10 mm diameter head	2.96
	600		2.20

## Colours and Textures

HardiePlank® weatherboard is available in a number of colours along with two surface texture finishes.

### ColourPlus™ Technology

This special surface treatment provides a durable, hardwearing, low maintenance and fade resistant colour finish.

- **Durable finish**  
We apply multiple coats to our weatherboard and trim. Extra thickness means extra resistance to protect your home.
- **Baked-on bond**  
Between coats, we cure the finish in a controlled environment for an even stronger bond that resists chipping, peeling and cracking
- **UV resistance**  
ColourPlus™ Technology has been engineered to better withstand the sun's damaging ultraviolet rays, providing up to 30% more fade resistance than many alternative cladding finishes and paint that's applied on-site.





Surface texture finishes



**Cedar**

(Available for HardiePlank® weatherboard and HardiePlank® VL weatherboard)

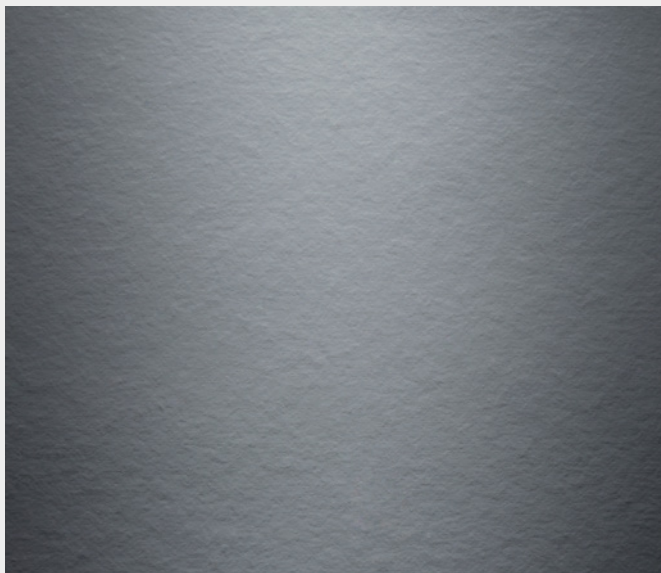

**Smooth**

(Available for HardiePlank® weatherboard)

# 03 Trims, Accessories and Tools

## 3.1 Trims

### Metal profiles

Metal corner profiles provide an alternative design option and are manufactured from a 2 layer polyester precoat paint system. They come with a removeable film for protection during installation.

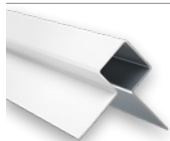

Ext. corner

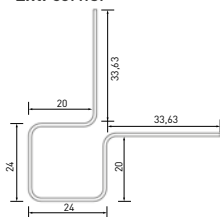

length:  
3 000 mm

Available in 21  
colours\*



Int. corner

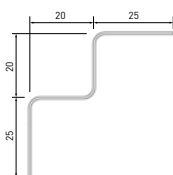

length:  
3 000 mm

Available in 21  
colours\*

\*Information on product codes can be found in the currents James Hardie UK price list.

### HardieTrim™ NT3™ Trim

### Product Code

HardieTrim™ NT3™ Trim is a complementary fibre cement trim available in two sizes, three colours and has a smooth finish.



Dimensions:  
90 × 3 655 × 25 mm

Arctic White

5671402

Sail Cloth

5691402

Midnight Black

5951402



Dimensions:  
140 × 3 655 × 25 mm

Arctic White

5671422

Sail Cloth

5691422

Midnight Black

5951422

### Key values

Weight per piece

9.4 kg (90 mm) and 14.9 kg (140 mm)

Raw density

900 kg/m<sup>3</sup>

**HardiePanel™ MetalTrim™ External Corner Profile**

This smaller box profile is suitable for open joint details where HardiePlank® weatherboard is used.

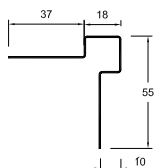

length:  
3 000 mm

Available in  
21 colours\*

3

The following trims are specific for HardiePlank® VL weatherboard installation

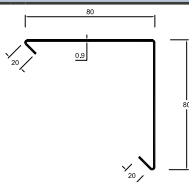
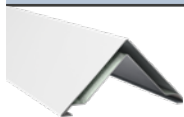
**HardiePlank™ VL 2-Part External Corner Trim**

length:  
3 000 mm

Available in  
6 colours\*

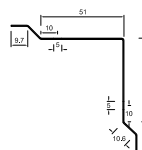
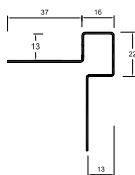
**HardiePlank™ VL Window Reveal Trim**

length:  
3 000 mm

Available in  
6 colours\*

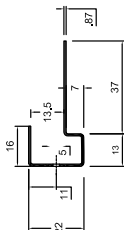
**HardiePlank™ VL Window Head & Vertical Starter Trim**

Slots 50mm in from each end

length:  
3 000 mm

Available in  
6 colours\*

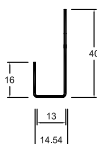
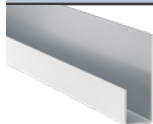
**HardiePlank™ VL J Profile**

length:  
3 000 mm

Available in  
6 colours\*

## 3.2 Accessories

HardiePlank™ starter ventilation profile		Item No.
Provides sufficient kickout for horizontal overlap only		
	Length:	3 000 mm
	Available in three standard depths	
	25 mm	5300182
	38 mm	5300183
	50 mm	5300184

HardiePlank™ Ventilation profiles		Item No.
For other types of application		
	Length:	3 000 mm
	Available in three standard depths	
	25 mm	5300185
	38 mm	5300186
	50 mm	5300187

HardiePlank™ VL starter profile		Item No.
Provides lower edge support for horizontal applications		
	Length:	3 000 mm
	Please note: The starter profile must be installed level and flat.	
		5300190

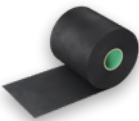
EPDM Tape		Item No.	
To protect the timber batten wherever there is a vertical joint in the cladding.			
	Length:	20 m	
	Thickness:	0.7 mm	
	Width:	60 mm	5300153
		80 mm	5300154
		100 mm	5300151
120 mm		5300152	

HardieSeal™ Edge Coating		
To seal all cut edges and cover small areas of damage, such as chips and scratches.		
	Colours	Available in all 21 colours
	Size	1 litre

HardiePlank™ screw		Item No.
	HardiePlank™ screw for timber.	5300309
	T15 Torx, A2 stainless steel, 4.2×40 mm, with 10 mm low profile head. Primarily for installing HardiePlank® VL weatherboards but can also be used for the installation of HardiePlank® weatherboards in horizontal overlap option.	

HardiePlank™ coloured screws		Item No.
	HardiePlank™ coloured screw for timber.	Available in 21 colours*
	T20 Torx coated head, A2 stainless steel, 4.8×38 mm with 12 mm domed head diameter. Primarily used for when a visible fixing is required.	

HardieClip™ reinforcement clip		Item No.
	Reinforcing clip which gives extra strength and stability for areas subject to higher wind loads. Only use with the overlap weatherboard solution.	5300156

## 3.3 Tools

**Gecko Gauge****Item No.**

Gauges to support weatherboard for a one person installation. For HardiePlank® overlap weatherboard only.

5000015

**HardieBlade™ saw blade****Item No.**

Specially designed to cut through fibre cement, producing a lower amount of dust due to less teeth than a standard sawblade. Suitable for use with most mains-powered/battery-operated circular saws.



Ø 160 mm

20/16\* mm bore

5300163

Ø 190 mm

30/20\* mm bore

5300164

Ø 254 mm

30 mm bore

5300165

Ø 305 mm

30 mm bore

5300166

\* Reducing washer supplied

**HardieGuillotine™ cutting tool****Item No.**

For all square edge cuts, eliminating dust. The preferred method of cutting HardiePlank® boards.

5300157

### 3.4 Other accessories

The following items may be required for the installation of HardiePlank® and HardiePlank® VL weatherboard (design dependent).

These items are not supplied by James Hardie but are available to purchase at any builders merchant.

Battens	
Timber battens	These provide support for HardiePlank® weatherboard and also ensure a ventilation cavity, which must be min. 20 mm. Battens must be a minimum of 20 mm x 50 mm, depth and width.
Steel battens	Metal Top Hat with dimensions, 15 x 27 x 80 x 27 x 15 mm in 1.5 mm galvanized steel. Length 3000 mm. Supplier: Protektor UK, Protektor House, Hoo Farm Industrial Estate, Kidderminster, DY11 7RA - 01562 515 200 Product Code 5006

Fixings for HardiePlank® weatherboards	
Nail Gun	James Hardie recommends the Paslode IM45 with fixing size, min. 2.8 x 32 mm with 7 mm diameter head. Other first fix gun nailers can be used – Fixing size 2.8 x 51 mm with 6.5 mm diameter head.
Hand Nailing	Ring shank nails of 3.0 x 50 x 10 mm diameter head.
Screwing	For timber use stainless steel screws, with a countersunk head, min. 4.0 x 35 mm with 8 mm diameter head. For steel use a stainless steel drill tip Faynot screw 34 mm long, countersunk head screw for metal, Suitable for fixing into metal profiles 1.5 to 3 mm thick. Supplier Contact: Protektor UK (as above) Product Code = P3-3,5xL - 735034-052

Fixings for HardieTrim™ NT3™ Trim	
Nail Gun	Second fix brad nail 50 mm x 16 g
Screwing	Use 3.5 mm x 50 mm stainless screws with 8 mm diameter self-embedding head.

Waterproof Membrane	
The HardiePlank™ system is not airtight, watertight or water-vapour tight. When used on timber stud walls or aluminium or steel frames it must be backed by a breather membrane acting as a vapour-permeable water barrier, incorporated behind the weatherboard under the supporting battens or steel frames. This breather membrane must meet the requirements of BS 5250:2011 and have a vapour resistance less than 0.6 MN · s · g <sup>-1</sup> .	

Jigsaw Blades	
Bosch jigsaw blades T141 HM or equivalent.	

## 04 Storage & Handling

### Storage

All products must be stored on a dry and level surface. Products stored outside should be covered with a waterproof covering, in addition to the product packaging to avoid contact with water and dust.

Wet products must not be installed. Installing wet weatherboard will result in shrinkage at butt joints. James Hardie accepts no responsibility for damage caused by improper storage and handling of the product.



**Warning:** Wet products must not be installed.



## Handling

Always carry planks with the edges held vertically, to avoid the planks bending. This also applies to lifting the board off the pallet to avoid potential scratch marks or damage - do not drag the boards off the stack. Each board comes with a surface

protective PE film to offer optimum protection during transport, cutting and installation. PE is an environmentally friendly polymer, which can be recycled.



The HardiePlank® VL boards are interlocked on the pallet. They must be removed individually by carefully

sliding apart, then lifting onto their edge.

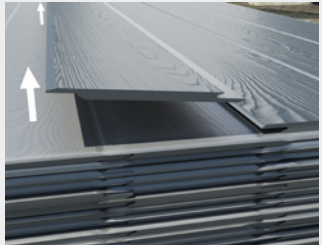
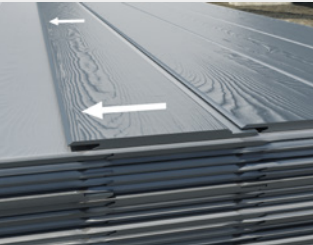

# 05 General Fixing Information

## Cutting

**All forms of cutting and drilling must take place in a dry, well ventilated environment**

As with all other building materials, safety precautions must be taken to avoid dust issues when cutting and drilling. Dust from the fibre cement boards is characterized as mineral dust and EU-approved FFP2/3 respirators must be used in conjunction with the following cutting practices to further reduce dust exposure;

- HardieGuillotine™ cutting tool:  
For all square edge cutting (for HardiePlank® weatherboard only)
- HardieBlade™ sawblade:  
For HardiePlank® VL weatherboard and all ripping down and angle cutting

- Hand Saw (with hardened teeth):  
For low to moderate cutting only
- Jig Saw (with specialist blade):  
For scribing and notching out

NEVER use a power saw indoors.  
NEVER use any other saw than a diamond saw blade.  
NEVER use an angle grinder or a standard circular saw blade as they produce too much dust.  
NEVER dry sweep when cleaning up debris, as it may excite silica dust particles into the users breathing area.  
ALWAYS follow the tool manufacturer's safety recommendations.



When using the HardieGuillotine™ cutting tool, the painted face of the board must be upward facing.



When using the HardieBlade™ sawblade, most circular saws will require the painted face of the boards to be downward facing. We advice this to be double checked prior to cutting.

Important Note: HSE approved respirators should be used in conjunction with above cutting practices to further reduce dust exposure. If concern still exists about exposure levels or you do not comply with the above practices, you should always consult a qualified industrial hygienist or contact James Hardie. For further information, refer to our Material Safety Data Sheet available at [www.jameshardie.co.uk](http://www.jameshardie.co.uk).

## Sealing

All on-site cuts of the HardiePlank® weatherboard and HardieTrim™ NT3™ Trim must be sealed with HardieSeal™ edge coating PRIOR to installation. HardieSeal™ edge coating must be applied with a small paint pad or

washing up sponge. When sealing the cut edges, wipe any excess paint from the front face immediately.

Do not apply the edge coating to the front of the boards.

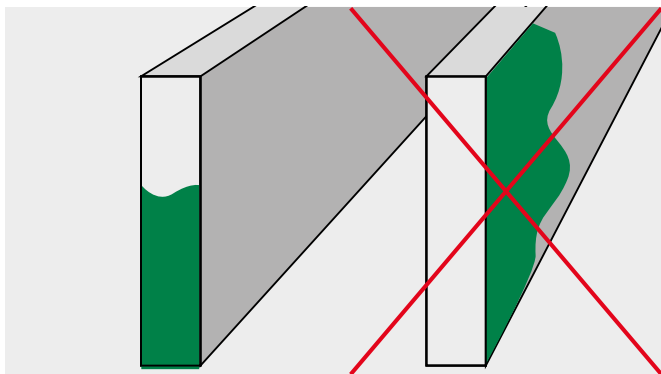

Along with cut edges, HardieSeal™ edge coating will need to be applied to any exposed back edges of the boards. This is common when using HardiePlank® weatherboard on edge into window/door reveals.

HardieSeal™ edge coating may also be used to deal with small scratches and marks less than 6 mm along with any exposed fixing heads. It should be used sparingly and only on the affected area otherwise it may become visible.



## Ventilation

All James Hardie external products are installed as per a ventilated rain-screen system. Failure to do so will have implications on the warranty and performance of the product.

A free-flow ventilation gap of a minimum of 20mm should be provided between the cladding layer and the substrate.

It is critical that an air inlet and outlet gap of a minimum of 10mm is left at the base and at the roofline, also below and above doors/windows.

Use a perforated enclosure to prevent pests entering through the ventilation gap.



→ Green: Air inlets      → Blue: Air Outlets

### Construction

James Hardie does not specify the fastening requirements for the sub-frame and therefore, will not accept liability for structural elements. The fixing of the framing should be incorporated into the overall building design and should be approved by the responsible parties.

### Structure

The structural wall to which HardiePlank® weatherboard is to be fixed must be of sufficient strength and stiffness to satisfy the require-

ments of the local building regulations. The wall may be of masonry or framed construction.

### Waterproof membrane

If required, fix a waterproof membrane to the outer face of the structural wall, with an overlap between the layers of membrane of at least 150 mm. Ensure the waterproof membrane is lapped to drain any water to the outside of the building. James Hardie will assume no responsibility for water infiltration.

### EPDM gasket tape

The EPDM gasket tape provides additional weather protection to the timber battens to prevent them rotting prematurely. It replaces the need for mastic seals wherever there is a joint within the cladding. When two planks abut each other simply cut a piece approx. 200mm length to insert behind the joint. Please be mindful to not oversail the bottom edge of the HardiePlank® weatherboard as the EPDM should not be visible. Tack the EPDM in place prior to fitting the HardiePlank. Ensure the plank fixing also retains the EPDM.



The only areas where the EPDM tape is used on the full length of the timber batten is when HardieTrim™ NT3™ Trim are used on corners and around windows and doors. Also, where a HardiePlank® weatherboard is used on edge as a reveal piece, the EPDM tape is wrapped onto the timber either side of the window or door frame. When installing onto full lengths, use a heavy duty staple gun with two staples every 400 mm centres.



### HardieClip™ reinforcing clip

This reinforcing clip is used with the overlapped detail for additional fixing support in high wind load areas. It ensures the correct positioning of the fixing and the use of 600 mm fixing centres in high wind pressure zones. Place the clip over the top of the plank with the long leg facing outward on the centre of the batten and apply a nail through the centre of the pre-punched hole. At joints, place the clip centrally over two boards and fix using the two outside fixing holes.



## Framing

For horizontal weatherboard install battens vertically. Do not install battens in any way that will restrict the airflow through the cavity.

Batten centres are typically set at 600 mm reducing to 500 mm or 400 mm at the boundary areas of the

building, up to a building height of 4 storeys. Seek advice from a professional engineer regarding batten centres along with our wind load information on pages 6 & 7, as these correspond to the wind load calculated for the contract. Where required consult a structural engineer to check the required support centers for your project.

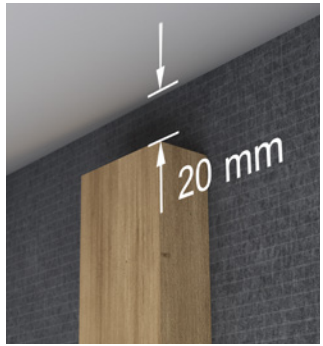
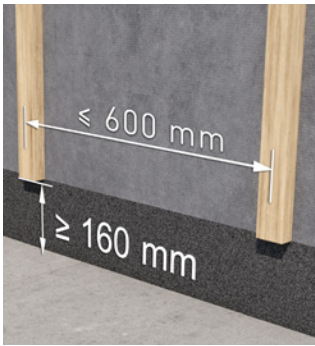

The battens should be positioned 10 mm higher than the recommended clearance and 20 mm down from the soffit/window cill to accommodate the 10mm drip edge to the weatherboard.

All battens should be level. Any irregularities within the main substrate can mirror through the finished application, potentially leaving a bowed

look within a long elevation run. If the wall is uneven, it is advisable to either pack out the frame to make good or use a helping hand bracket system.

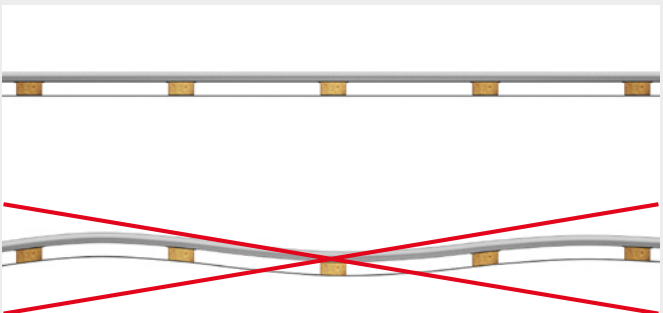

## Clearances

Do not install JamesHardie® products such that they may remain in contact with standing water. Install

the weatherboard in compliance with local building regulations requirements for clearance between the bottom edge of the cladding and the adjacent finished grade.



This is typically 150 mm if the ground is of soft terrain.



Maintain a min. 50 mm clearance between HardiePlank® weatherboard and a hard surface eg. roofs and concrete paths, steps and driveways.

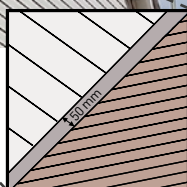

Min. 50 mm gap

## Wall penetrations

When a penetration in the wall is required for a pipe or tap for example, form a hole in the plank using a carbide tipped hole saw. Make the hole approx. 6 mm larger than the diameter of the pipe. Seal between the fitting and the edge of the hole with a high quality exterior sealant. If the space between the fitting and the hole is too wide, use a polyethylene foam-backing rod to fill the major part of the gap. The remaining gap should be filled with sealant.



## Load fixing

JamesHardie® fibre cement products are not intended as a load bearing or shear element in the wall construction. Items required to be attached to the wall should be supported directly by connections through to the structural sheathing and/or framing members, not attached to the weatherboard or trim as the primary load-bearing elements. Do not fix directly to the weatherboard.





## MetalTrim™ External Corner Trims

### Important note:

**MetalTrim™ corner profiles must only be installed vertically.**

### Cutting MetalTrim™ corner profiles

1. Cut the MetalTrim with a suitable saw or shears.
2. Ensure that the cuts are clean and straight.
3. Ensure that the trim is not damaged during cutting.

### Installation

Fix the trim with stainless steel nails. A fixing can be positioned at the top middle and bottom to hold trim into place as the fixing for the HardiePlank® weatherboard will also go through metal wing of the trim, fully securing it into place. Be sure to position the metal trim correctly prior to weatherboard as this cannot be adjusted after the HardiePlank® weatherboard has been installed.

Be sure to oversail the bottom and top edge of the timber batten by 10 mm. This is to accommodate the drip edge to the first and last board meaning both corner trims and weatherboard are all level.



**Attention:** Please make sure to always wear gloves when cutting the trims.

When joining pieces of trim together ensure that the trim is correctly aligned prior to fixing. Pay attention to thermal expansion where exposure of the HardiePlank™ MetalTrim™ to sun is extreme.

It is imperative that the plastic protection is removed immediately after installation otherwise it will become trapped behind the weatherboard and be difficult to remove.

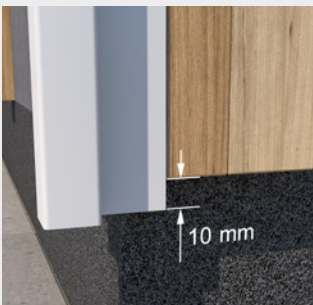

## HardieTrim™ NT3™ for external corners

### Installation

HardieTrim™ NT3™ profile can be easily gun nailed. Always check the fixing pressure of the gun, if incorrect the product can be damaged. Fix with second fix brad nails 50 mm × 16 g. Profiles need to be flush nailed or overdriven (by 1 mm max) so nail heads only need to be painted.

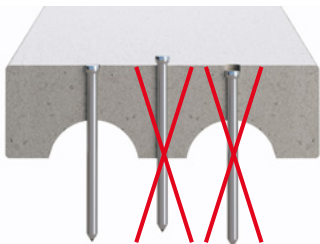

HardieTrim™ NT3™ profiles should be pre-assembled on the ground, this will allow an easier and more level installation. Fix the corner profiles at 400mm down the length, 25mm in at the ends and 12mm in down the long edges. Ensure the bottom of the trim overhangs the bottom of the batten by 10mm. This is to accommodate the drip edge to the first and last board meaning both corner trims and weatherboard are all level. Where the cladding height is greater than the length of HardieTrim™ NT3™ profile (3.65 m) it will be necessary to butt joint corner trims. This should be done by offsetting the ends of the trim by 300mm to provide a staggered horizontal interlock and not a straight butt joint. Not only is the detail stronger, but it also is aesthetically more pleasing.



If you do not have access to a brad nail gun, the HardieTrim™ NT3™ profile can be installed with stainless steel screws. The screw size should be 3.5 mm × 50 mm with a countersunk head. Pre-drill the HardieTrim™ NT3™ profile with a 3.5 mm masonry bit and countersink the hole. Install the screws 25 mm down from the top edges and then in every 400 mm down the length of the trim. The screws

should have their heads driven slightly below the surface of the product. Carefully fill the countersink with a suitable exterior grade filler, allow to fully cure before painting just the head area with HardieSeal™ edge coating and apply with an very small brush. Do not overpaint onto the surrounding area, keep the paint to just the filled head of the screw.

# 06–09 Installing the HardiePlank® family

<b>06</b>	<b>Horizontal installation of HardiePlank® weatherboard (overlap)</b> Technical Details	<b>p. 28</b> p. 36
<b>07</b>	<b>Vertical Installation of HardiePlank® weatherboard (hit and miss)</b> Technical Details	<b>p. 44</b> p. 45
	Installation of HardiePlank® Open Joint (Horizontal & Vertical)	p. 48
<b>08</b>	<b>Horizontal Installation of HardiePlank® VL weatherboard</b> Technical Details	<b>p. 50</b> p. 56
<b>09</b>	<b>Vertical Installation of HardiePlank® VL weatherboard</b> Technical Details	<b>p. 61</b> p. 62



HardiePlank® weatherboard  
horizontal installation



HardiePlank® weatherboard  
vertical installation

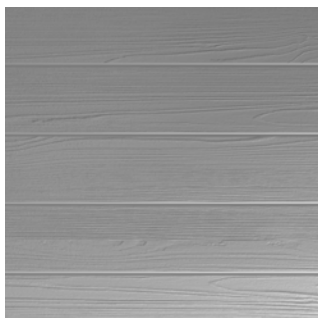

HardiePlank® VL weatherboard  
horizontal installation



HardiePlank® VL weatherboard  
vertical installation

## 06 Horizontal installation of HardiePlank® weatherboard (overlap)

General Arrangement



## Fixings

HardiePlank® weatherboard can easily be gun nailed. It is essential that the pressure of the gun is adjusted so the fixing will sit flush with the board surface. If incorrect the product can be damaged and not hold sufficiently.



Fix the weatherboard to the vertical timber battens with one nail or screw on **every** batten. The centre line of the nail or screw should be 20–25 mm below the top edge of the weatherboard. When fixing the ends of the cladding ensure the fixing is placed 15 mm in from the edge.

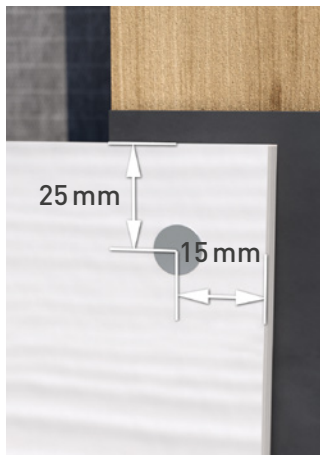

## Base Detail

### Starter Ventilation Profile

The easiest way to ensure the correct detailing for the first plank is by installing the combined starter and ventilation profile.

An alternative could be to cut a 30mm wide starter strip from a sheet of HardiePlank® weatherboard to kick out the first plank to match the lap of the wall. Nail this along the front face of the battens so the lower edge of the starter strip lies along the line made by the bottom of the vertical battens. This provides the lap spacing for the first row of plank. The omission of this strip will result the “kick-out” on the wall appearing inconsistent in the second, third and fourth courses.

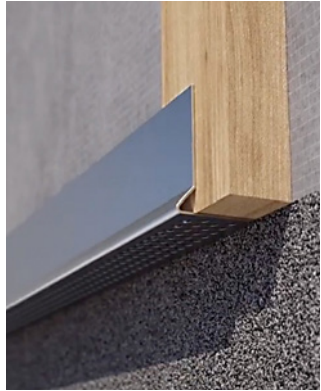

6

### Ventilation path

Please allow for sufficient inlet of air. Anything disrupting this, like a horizontal batten or not enough clearance, will prevent the system from working correctly.

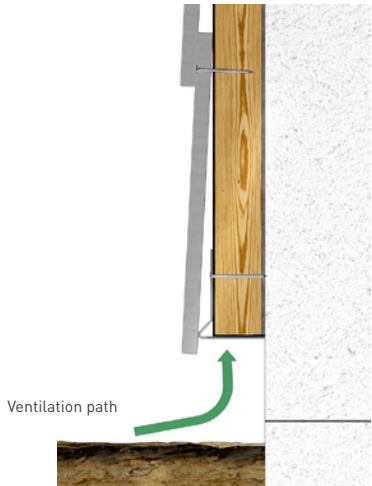

## Top Detail

### Ventilation Profile

When installing the ventilation profile at the roofline, be sure that the timber battens are 20 mm down from the soffit. Then dress the top of the batten with the perforated profile. This means, when the last board is installed, level with the top edge of the corner trim, both timber and vent profile will not be seen.



### Ventilation path

It is essential there is a min. 10 mm gap between the top edge of the last piece of HardiePlank® weatherboard and the soffit. This gap allows for a sufficient outlet of air. Anything disrupting this, a horizontal batten or if the gap is sealed for example, will prevent the system from working correctly.

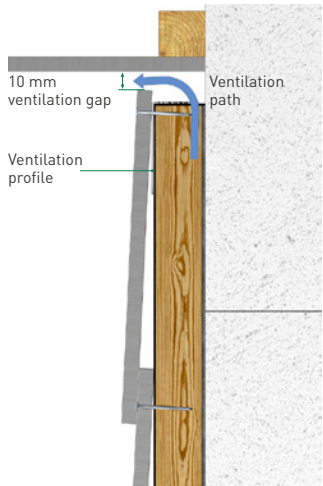

**Fitting the first HardiePlank® weatherboard**

There has to be a min. 10mm drip edge at the lower edge of the first board installed. Mark 170mm up from the lower edge of the starter profile and ensure this line is level. This will then be the top of the first row of cladding resulting in a 10mm drip edge.

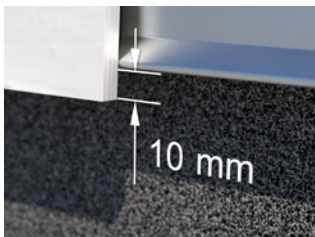

**6 Second and subsequent planks**

The second row of HardiePlank® weatherboard is placed so that the lower edge of the second plank overlaps the top of the first plank by min. 30mm. It is important to carefully maintain this dimension throughout the construction of the wall.





### Using the Gecko Gauge

A Gecko Gauge set to 150 mm will help speed up the installation. Alternatively, measure 150 mm up from the top edge of the plank and draw a line

on the battens, this gives the position for the top edge of the next plank. It is advisable to check with a spirit level every 4 or 5 rows to ensure the planks level is maintained.



### Fixing the last plank

In most situations it is unlikely that the planks will exactly fit the wall height, in this case it will be necessary to cut the last plank down in width. Measure down from the underside of the soffit to the top of the previous plank and then add 20 mm. This will allow the correct

overlap of 30 mm and top ventilation gap of 10 mm. The last fixing head will always be visible. This needs to be treated with HardieSeal™ edge coating which should be applied with a small paint brush. The paint should only cover the fixing head, not the pre-painted surface of the HardiePlank® weatherboard.

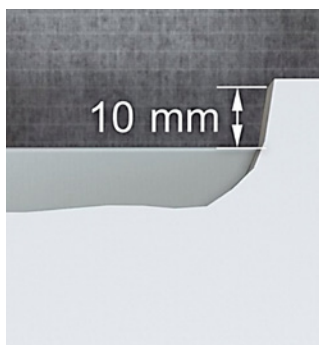

## Gabel Ends

When setting out the timber battens on a gable end, always remember to keep the frame vertical for free flow ventilation. There should never be a diagonal batten fixed up and down the apex. This would prevent air from escaping. To enable the pinning back of

the raked cut HardiePlank® weatherboard, install 200 mm offcuts of timber every 200 mm centres going up and down the apex. This will ensure that there is a timber close enough to the point which needs pinning back. The top edge of the planks should be down from the soffit by 10 mm.

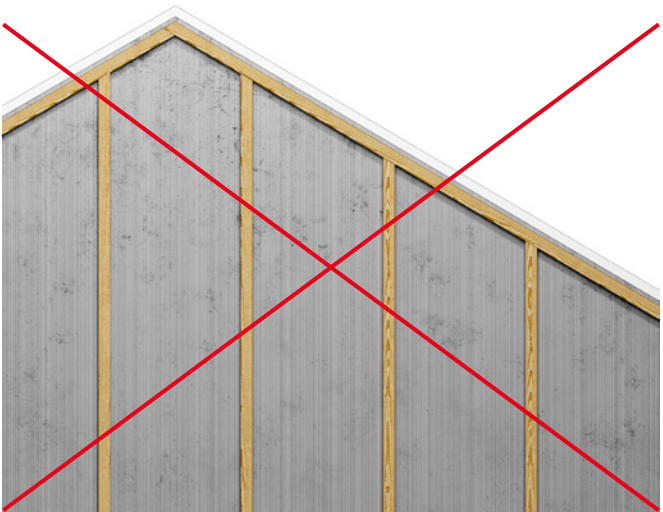
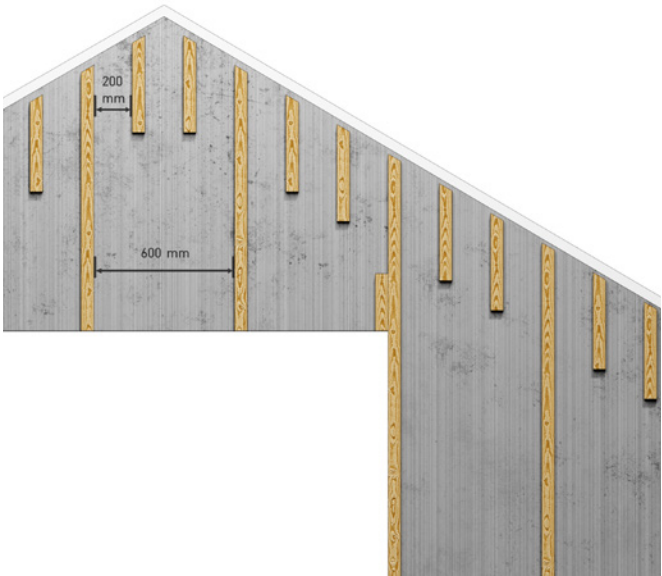

Install a second fix brad pin min. 15mm up from the lower edge of the HardiePlank® weatherboard, ensuring the fixing penetrates one of the timber battens. Be sure to carefully conceal the fixing head with HardieSeal™ edge coating.

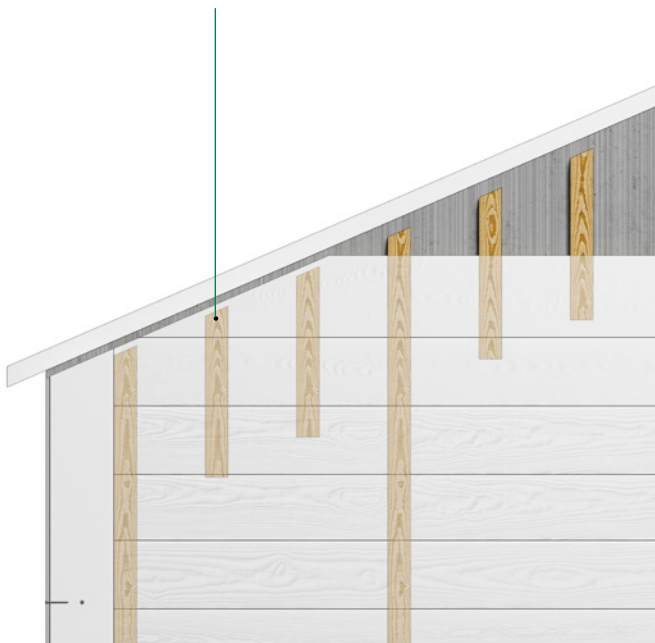

## External Corner Options

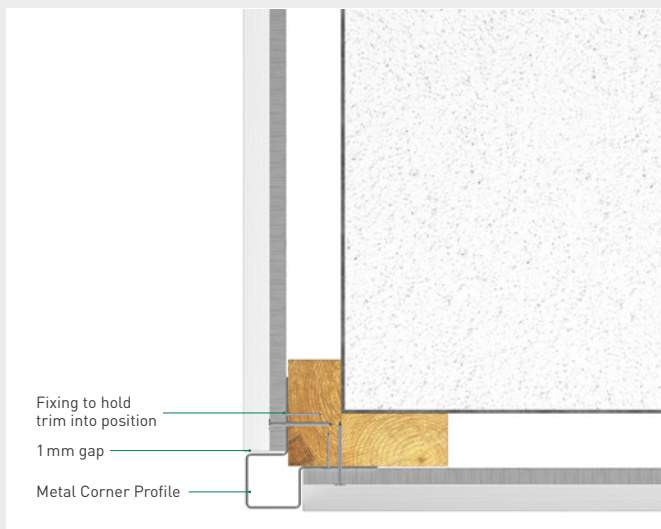

6

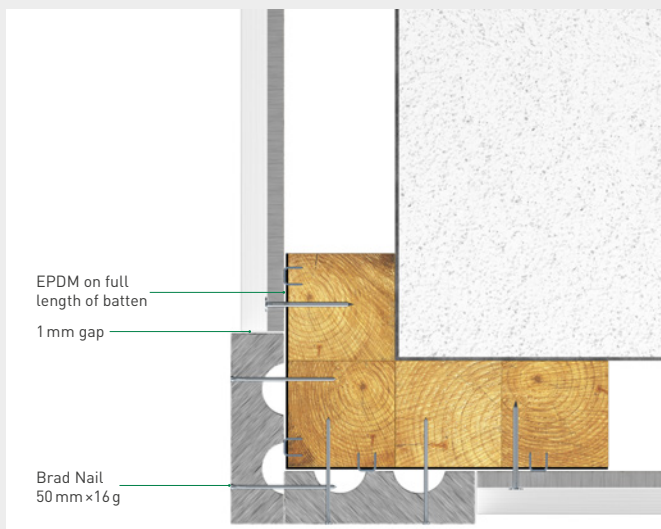

## Internal Corner Options

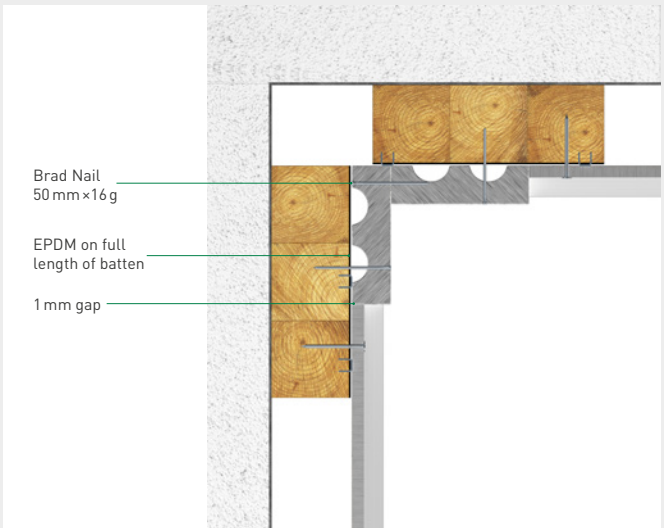
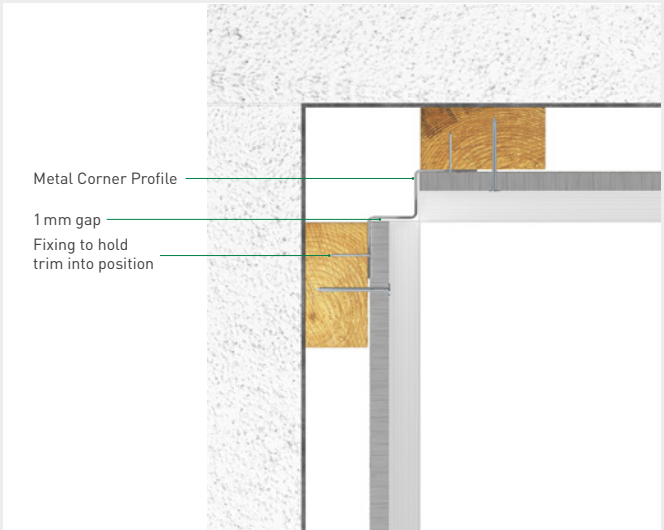

## Window Detail with HardiePlank® weatherboard On Edge



6

## Window Reveal

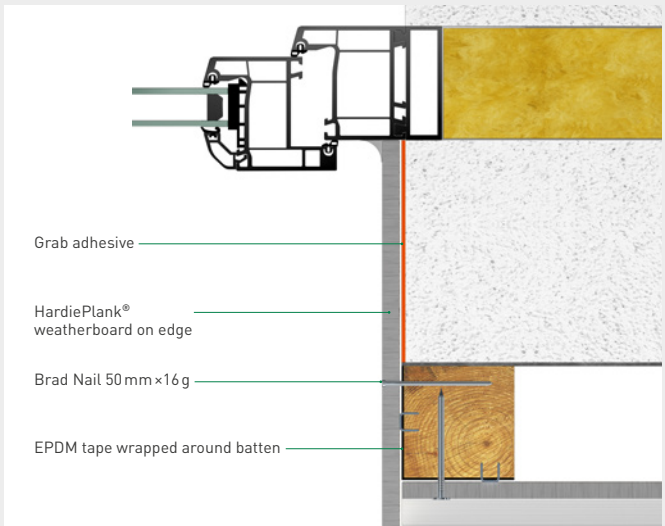

## Window Head

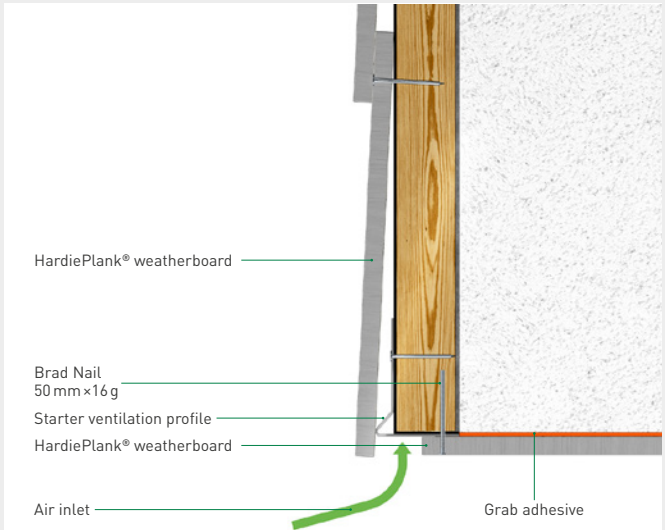

## Window Cill

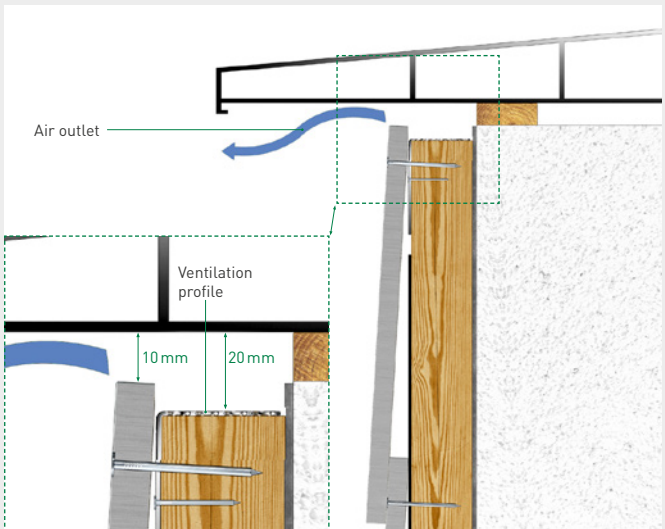

## Window Detail with HardieTrim™ NT3™ fibre cement profile



6

## Window Reveal





## Window Head

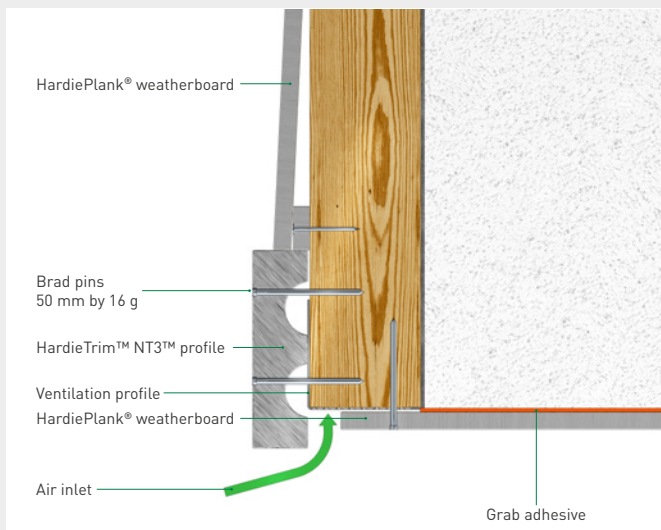

## Window Cill

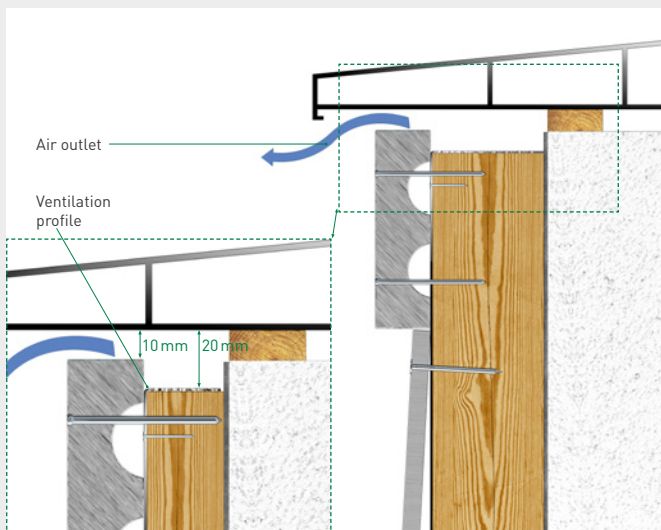

## Window Detail with External Metal Corner

### Window Reveal

When using the metal corner trim on a window reveal, be mindful to always use a 38 mm min. depth timber batten. This compensates for the length of the metal wing on the trim.

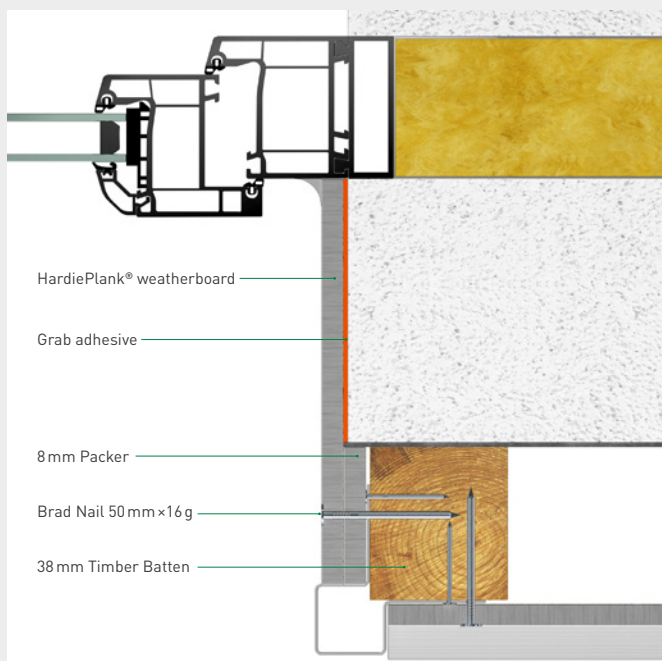

## Stop End Option

When a stop end is required on the same plane, it is advisable to rip down a piece of weatherboard to the required width, depending on the depth of the batten. Then second fix pin every 400 mm into the timber.

Ensure you oversail the ripped down stop end, min. 5 mm past the bottom edge of the weatherboard.

Paint a 30 mm strip onto the outside edge of the back face prior to installing.

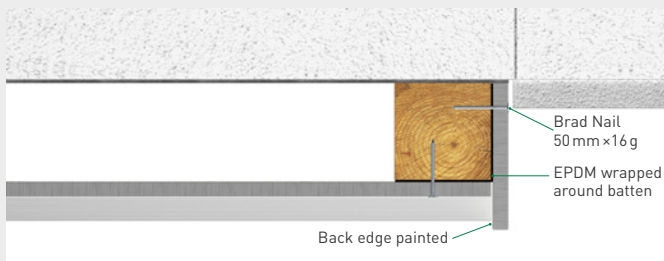

## Abutment Options

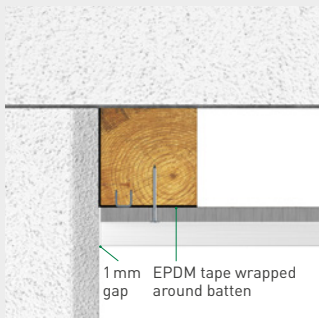
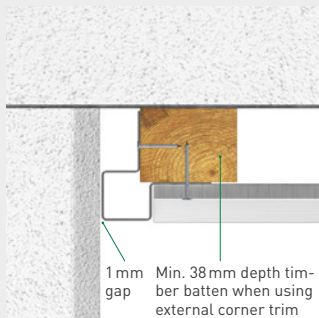

## 07 Vertical installation of HardiePlank® weatherboard (hit and miss)

### General Arrangement

To facilitate vertical installation and maintain sufficient ventilation, counter battens should be installed horizontally over the vertical frame to support the vertical planks. The centres for both vertical and horizontal timbers should not exceed 600 mm.

For vertical 'hit and miss', the first (inner) layer of HardiePlank® weatherboard is installed at 300 mm centres to leave 120 mm gap between boards.. The second (outer) layer then overlaps the first layer by min. 30 mm on both sides.

It is recommended that the HardiePlank™ coloured screws are used to fix the outer layer.

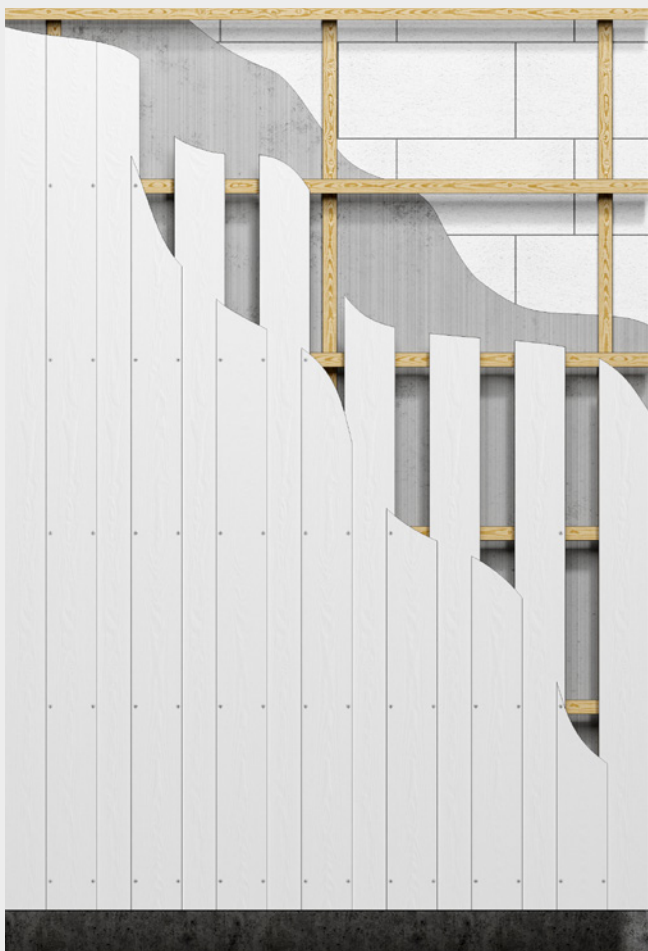

## Top Detail

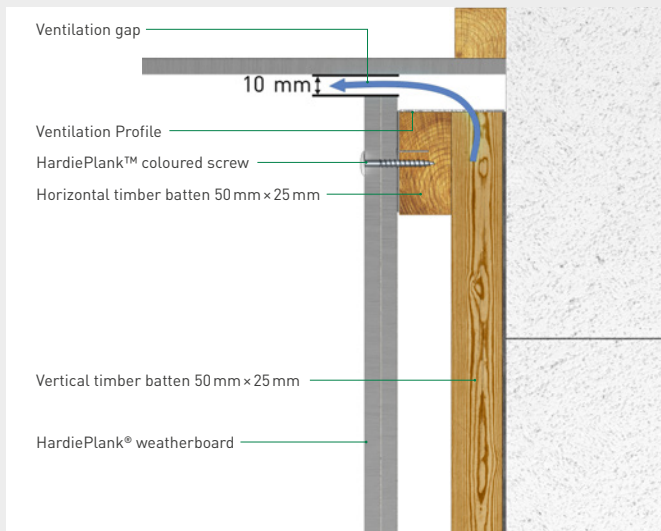

## Base Detail

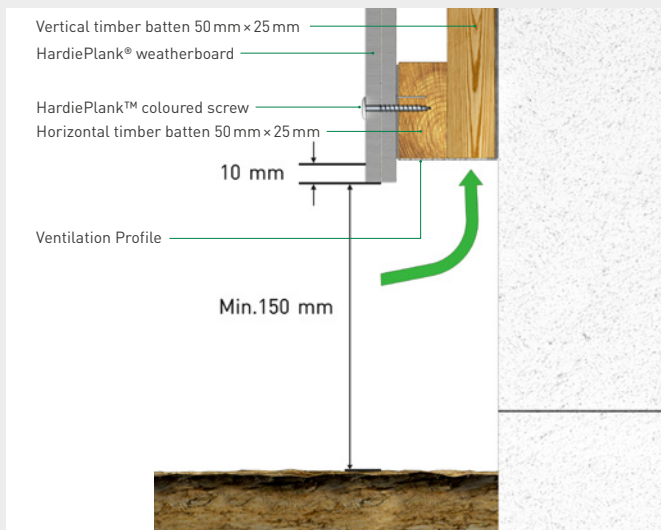

## Layout and Fixing Position

It is recommended that min. 25×50 mm timber battens are used for both the vertical and horizontal frame. This will keep the wall build up to a minimum.



Use the HardiePlank® weatherboard as a fillet piece to breach gap at bottom and top. Second fix pin these into position.

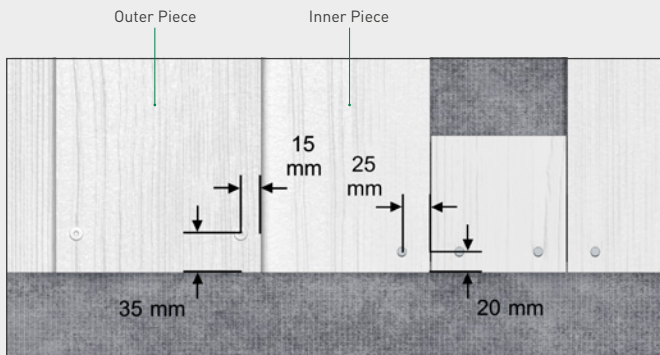
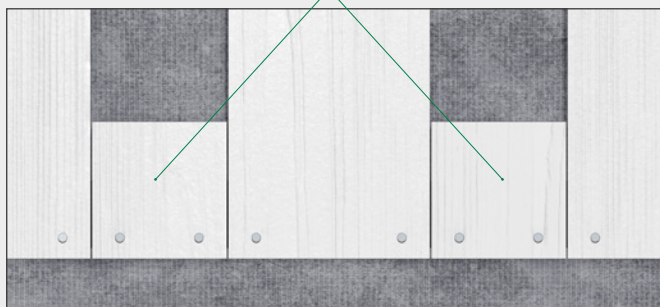

## External Corner Options

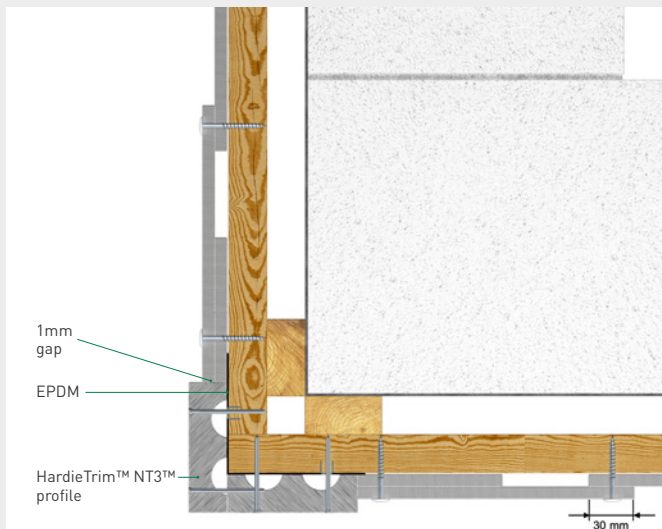
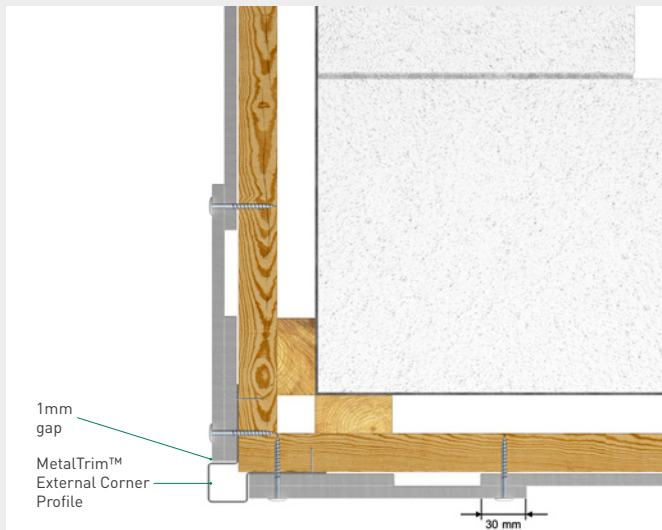

## Installation of HardiePlank® weatherboard Open Joint (Horizontal & Vertical)

### General Arrangement

As a popular application, HardiePlank® weatherboard can also be installed with an open joint detail both horizontally and vertically.

Follow the same framing method previously outlined as applicable for whichever detail.

The wall behind the facade will be subjected to rainwater from wind-blown rain entering the joints, therefore it is vital that it is 100% waterproof. If there is any doubt the wall should be waterproofed using a suitable breathable construction membrane.

Special care should be taken at the perimeters and the base of the weatherboard as wind-blown rain-water may reach the wall and can be blown back up untaped joints. James Hardie accepts no liability for water ingress into the building.

### Note:

All battens must be protected by the application of EPDM tape to their front face using suitable staples.

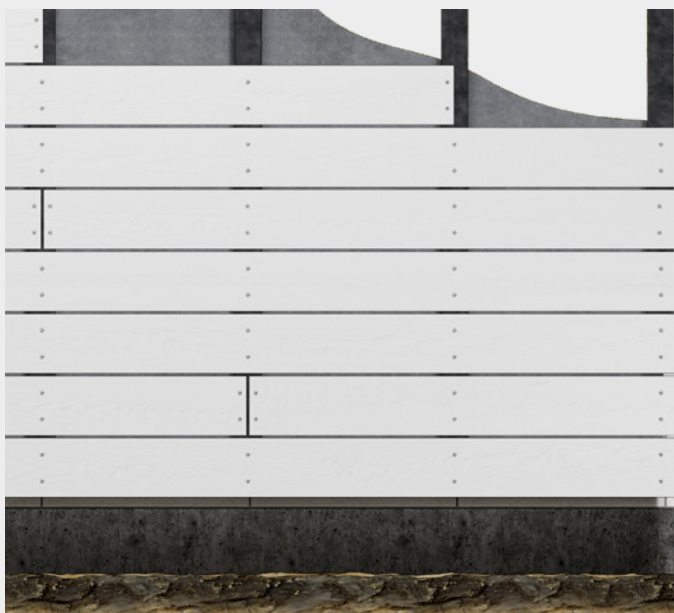



**Fixing Type**

It is recommended that the HardiePlank™ coloured screws are used due to the fixings being visible.

**Application**

It is critical to ensure correct drainage at the base of the facade to allow rainwater entering the system to escape. Correct through ventilation is also important to allow the rear of the system to dry out. A clear ventilated gap of 20 mm must be maintained behind the weatherboard with a continuous ventilation gap of 10 mm at the bottom and top of the facade. These should be protected from vermin with JamesHardie® ventilation profiles.

**Wind Pressures**

600 mm batten centres for single fixing point must not exceed 1025 Pa  
600 mm batten centres for double fixing point must not exceed 1780 Pa

**Batten Dimensions**

50 × 38 mm min. to accommodate the length of the fixing.

**Joint Width**

The maximum open joint width is 8 mm. The wider the gap, the larger the volume of water able to pass through. Smaller joints are preferable: 3 mm–5 mm.

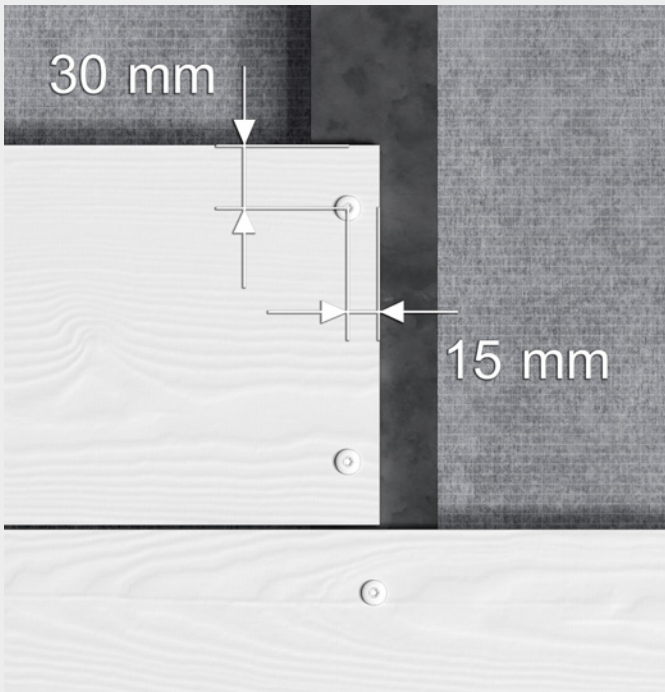

# 08 Horizontal Installation of HardiePlank® VL weatherboard

General Arrangement



## Fixings

The HardiePlank® VL weatherboard is easily installed with HardiePlank™ screws, pre-drilling is not necessary. The screws must sit flush with the surface of the board.

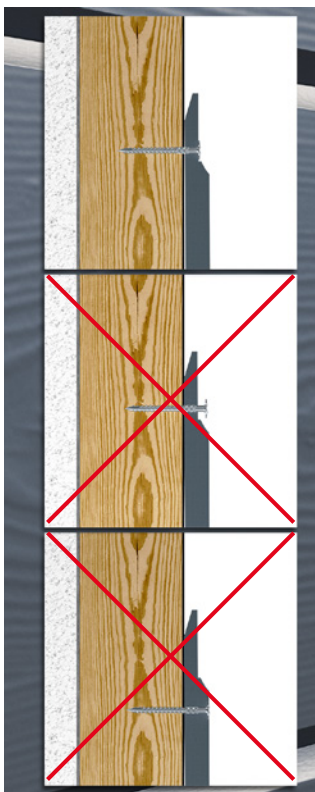

Fix through the tongue part of the weatherboard 25 mm down from the top edge. When fixing the ends of the cladding, ensure the fixing is placed 15 mm in from the edge.

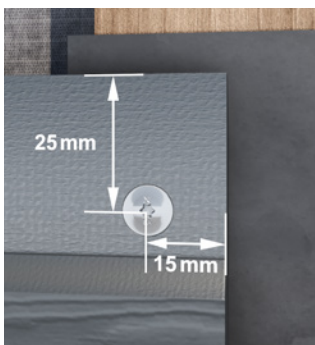

## Base Detail

### Starter and Ventilation Profile

The easiest way to ensure the correct detailing for the first plank is by installing the HardiePlank™ VL starter profile and ventilation profile.

The ventilation profile must be fitted first, as such so that the unperforated leg sits behind the timber batten between the substrate and batten. This will prevent build up to the front face of the batten once the starter profile is installed.

Then fix the starter profile level with the bottom edge of the timber battens, this then guarantees a 10 mm drip edge to the first board. Also, be sure to leave a 1 mm gap from the corner trim. Pre-drill the profile and fix with the HardiePlank™ screws.

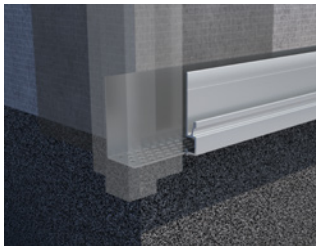

### Ventilation path

Please allow for sufficient inlet of air. Anything disrupting this, like a horizontal batten or not enough clearance, will prevent the system from working correctly.

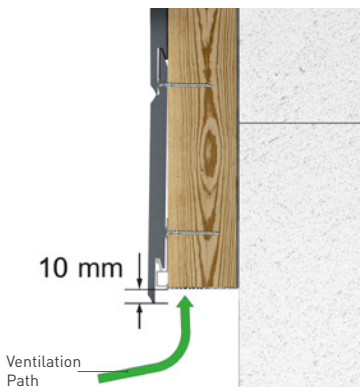

## Top Detail

### Ventilation Profile

When installing the ventilation profile at the roofline, be sure that the timber battens are 20 mm down from the soffit. Then dress the top of the batten with the perforated profile, with the unperforated leg to the front of the batten. This means, when the last board is installed, level with the top edge of the corner trim, both timber and vent profile will not be seen.



### Ventilation path

It is essential there is a min. 10 mm gap between the top edge of the last piece of HardiePlank® VL weatherboard and the soffit. This gap allows for a sufficient outlet of air. Anything disrupting this, a horizontal batten or if the gap is sealed for example, will prevent the system from working correctly.

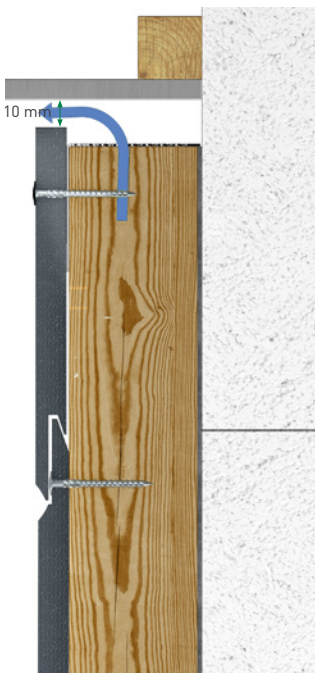

### Fitting the first HardiePlank® VL weatherboard

Start installing at a bottom corner of the building and fit the first HardiePlank® VL weatherboard by positioning it onto the starter profile. There will be a natural 10 mm drip

edge to the first board and it should always be in line with the bottom edges of corner trims. Then simply secure it to the timber batten using the HardiePlank™ screws. Leave a 1 mm gap between External Corner profile and end of cladding.

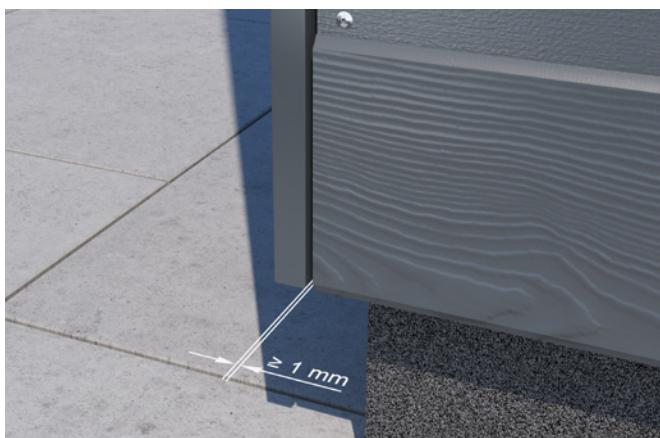

### Fixing the second and subsequent boards

Place the next board into position by carefully interlocking the grooved edge over the tongue of the previous course. On a level plane, the cladding

will interlock together with ease but should there be any irregularities within the substrate, tap carefully with a rubber mallet and a scrap piece of board, so the cladding sits together flush.

8

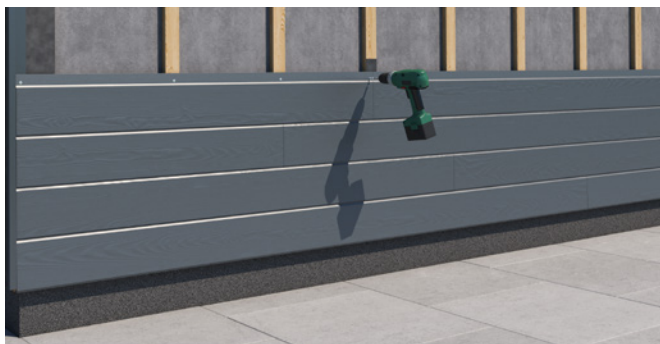

**Butt Joints**

At the butt joints, EPDM tape is fitted behind the joint to protect the timber batten. Be sure EPDM tape over sails the tongue of the board below so it sits within the interlock.

All butt joints are joined together tight but without using any force (i.e. hand pressure only).

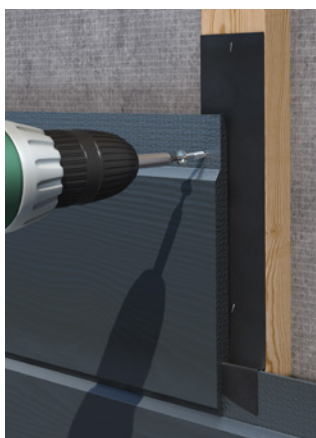

**Fixing the last board**

In most situations it is unlikely that the weatherboard will exactly fit the wall height, in this case it will be necessary to cut the last board down in width. At the very least, the tongue needs to be ripped off.

When cutting down to size, take into consideration a 10 mm ventilation outlet gap between the top edge of the board and the roof line. It will need to be fixed with the HardiePlank™ screw and then the head, filled and painted. Alternatively, use a HardiePlank™ coloured screw.

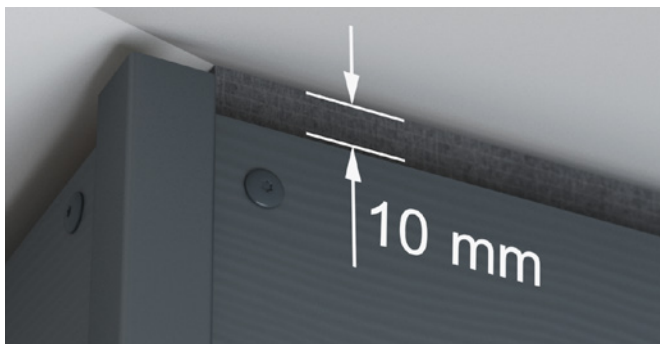

## External Corner Options

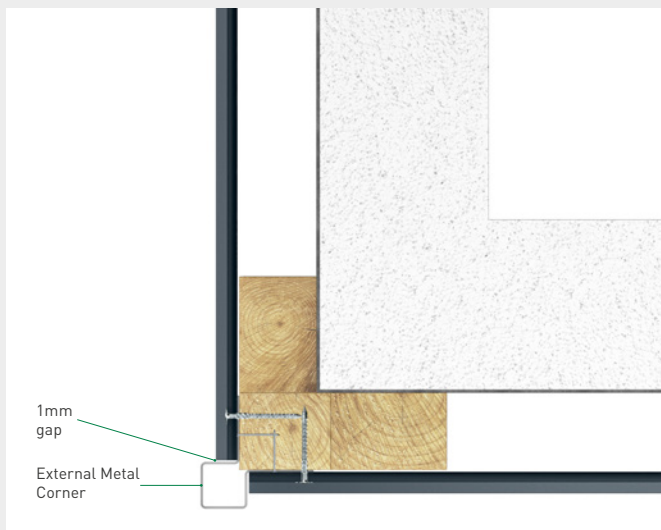

When installing the 2-Part VL Corner Profile below, screw the inner section over the cladding, with the HardiePlank™ screw, and then click the outer section

into position. One fixing will need to go through the outer trim to be sure it stays in line. It is recommended this goes at the top, out of eye line.

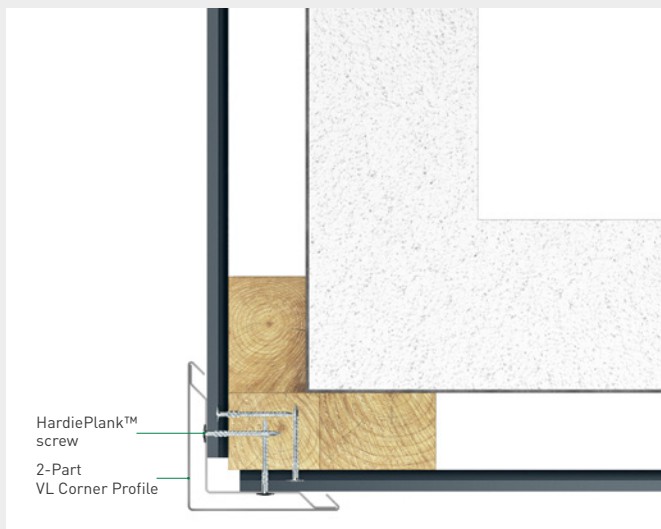



## Internal corner options

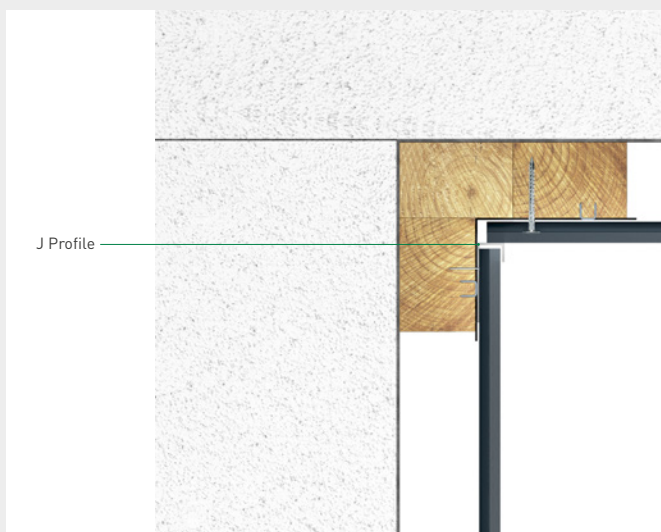
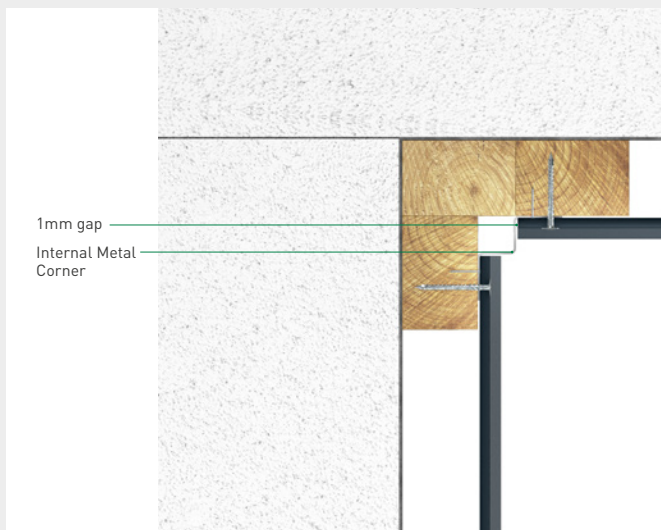

## Window Details with HardiePlank® VL weatherboard On Edge

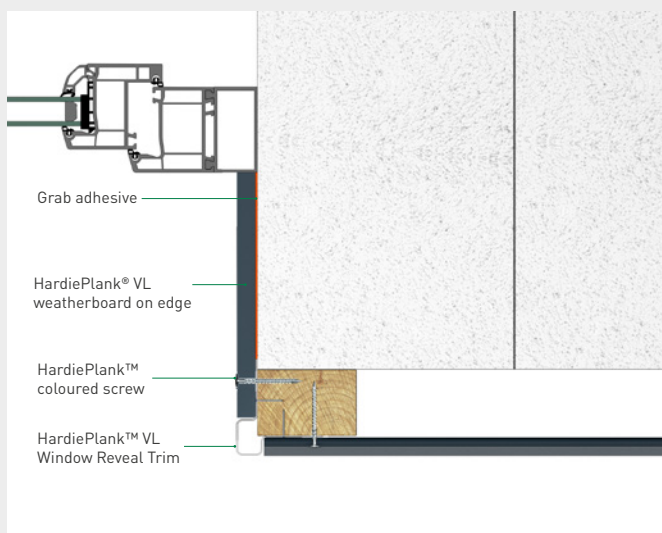

## Window Head

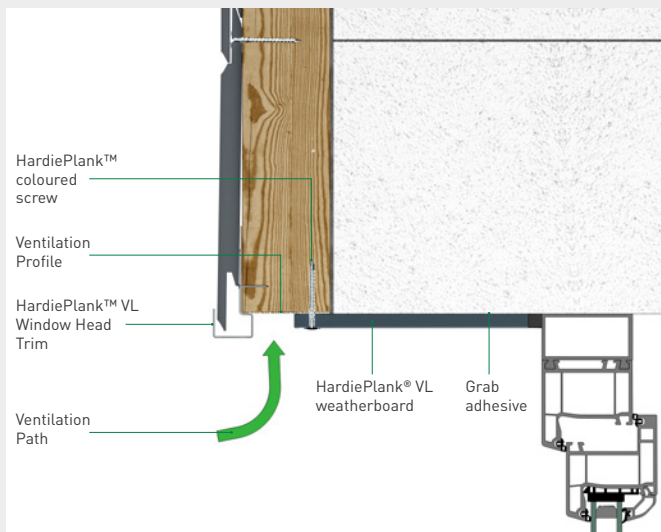

## Window Cill

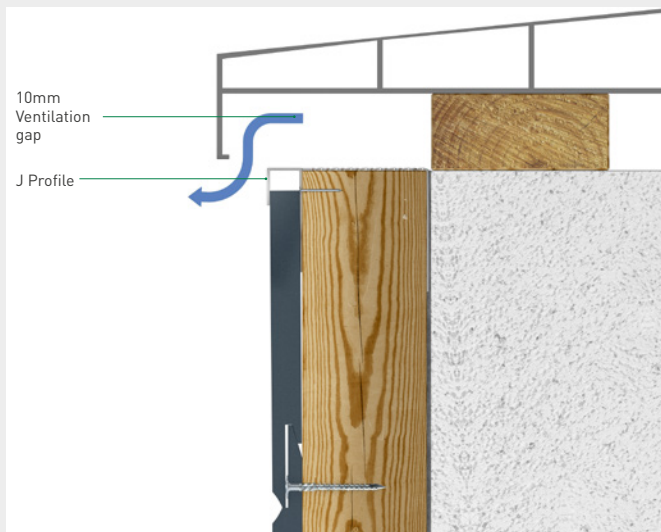

## Window Details with HardiePlank® VL weatherboard Line Cont.



# 09 Vertical Installation of HardiePlank® VL weatherboard

## General Arrangement

To facilitate vertical installation and maintain sufficient ventilation, counter battens should be installed horizontally over the vertical frame to support the

vertical planks. The centres for both vertical and horizontal timbers should not exceed 600mm centres.



## Top Detail

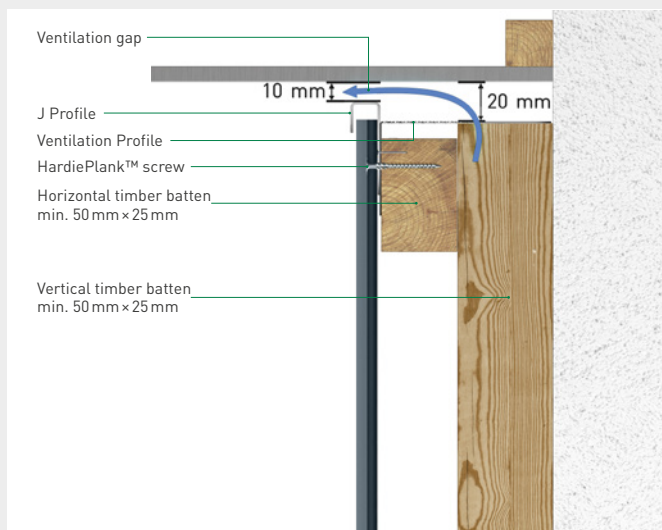

## Base Detail

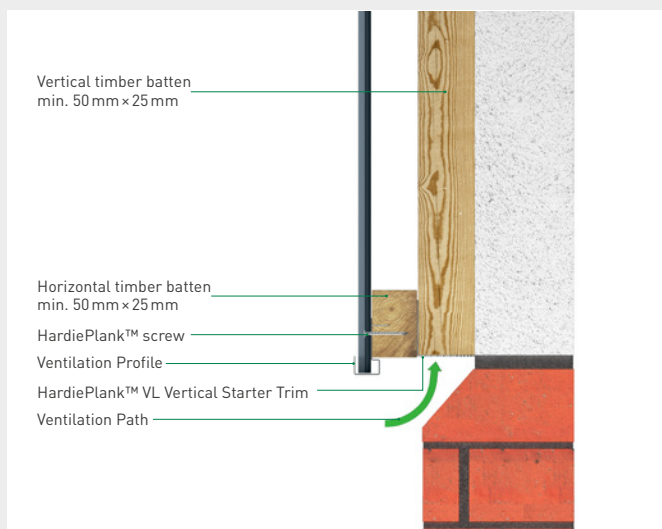

**Fitting the Vertical Starter Trim**

If using the Metal External Corner, notch out the metal wing by 50 mm from the lower edge up and position 13 mm lower than the timber batten. This is to accommodate the size of the starter trim and guarantee it sit level with the lower edge of the corner trim.

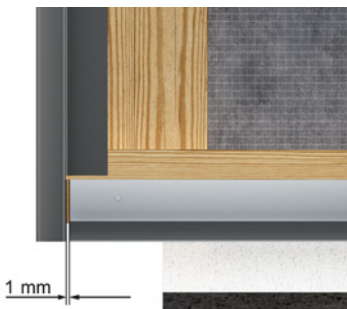
**Fitting the first HardiePlank® VL weatherboard vertically**

For a better finish, cut off the groove edge of the board so that you start with a square edge into the corner trim. Then, with the board positioned vertically, slot the lower edge of the board into the starter trim then butt into the corner leaving a 1 mm gap. The starter trim will both hold the planks into position and cover the cut ends.



**Fixing the second and subsequent boards**

The next board is also set into the starter profile then carefully interlocked with the first in such a way that a V-shaped joint is formed. On a

level plane, the weatherboard will interlock together with ease but should there be any irregularities within the substrate, tap carefully with a rubber mallet and a scrap piece of board, so the cladding sits together flush.



**Fixing into the soffit**

Use the J profile as a finishing detail between the top edge of the boards and soffit. Be sure to position the profile, 10 mm down from the soffit to

allow for ventilation. The boards are cut 8 mm shorter from the top edge of the profile to allow for sufficient movement when installing.

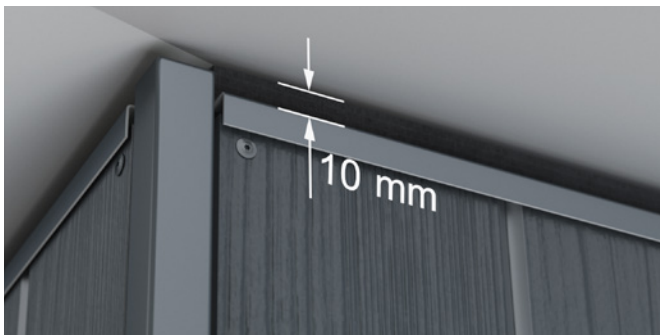



# 10 Maintenance

## Annual Inspection

Under normal atmospheric conditions HardiePlank® weatherboard does not require much maintenance to maintain its strength, properties and function. Environmental impacts may, however, influence the visual appearance of the facade weatherboard. Therefore, an annual inspection of the ventilation gaps, joints and fixings is a good idea. Detection and repair of possible damage will ensure a longer life for the facade weatherboard.

## Impact from Nature

The weather and nearby green plants may affect the appearance of the facade cladding. Pollution, dirt, leaves from trees, bushes and flowers will have an impact on the façades appearance. HardiePlank® Weatherboard is manufactured from weather resistant raw materials and will not be attacked by algae, rot and dry rot. Coastal locations can be very aggressive due to salt laden moist air and windblown sand. It is recommended that the frequency of inspection procedures in such locations be increased and that any maintenance be undertaken before damage occurs. It is recommended to pay attention to the corners of weatherboard specifically around window, doors and the corners of facade particularly those facing the prevailing wind direction.

## Repairing HardiePlank® weatherboard

HardiePlank® weatherboard should be replaced by removing the damaged board, gently lifting the board immediately above and inserting the new board. The board is then fixed by face nailing through the top board.

## Cleaning

HardiePlank® weatherboard can be cleaned with cold or lukewarm water, if necessary with the addition of a mild household cleaning agent not containing solvents. Always start from the top with well-defined areas. Rinse with plenty of clean water until the facade is perfectly clean. Before cleaning full scale, it is recommended to test the chosen cleaning method on a smaller area to make sure it is likely to be successful. The weatherboard should be cleaned a minimum of once a year.

### Important Note:

Do not use high pressure cleaning systems on fibre cement weatherboard, as this may damage the surface and paint finish.





The latest up-to-date version of this brochure can be downloaded from our website in digital form. Technical changes are reserved. Latest update: 11/2020

The current edition is valid in each case. Should any information be missing from this brochure, please contact our technical support team.

© 2020 James Hardie Europe GmbH.  
™ and ® denote registered trademarks and brands of James Hardie Technology Limited and James Hardie Europe GmbH

**Fermacell UK,  
branch of James Hardie Europe GmbH**

7 The Priory  
Old London Road  
Canwell  
Sutton Coldfield  
B75 5SH  
Tel. +44(0) 121 311 3480  
Fax +44(0) 121 311 1882

har-090-00022/11.20/m

