

LITO

CEILING INSTALLATION
28-10-2015

1.0

LED 2/3W | 350-500mA | 6Vf | PCB 3-step | excl. power supply

CE \diamond IP40 \square 960°C \downarrow 0,3m \oplus 10

3000K | >85CRI | 188-260lm

white texture	145181W4
aluminium anodised	145181A4
black texture	145181B4

ALWAYS USE

for power supplies see our catalogue

2.0

LED 2/3W | 350-500mA | 6Vf | PCB 3-step | excl. power supply

CE \diamond IP40 \square 960°C \downarrow 0,3m \oplus 10 \triangle DO NOT COVER

3000K | >85CRI | 188-260lm

white texture	145281W4
aluminium anodised	145281A4
black texture	145281B4

ALWAYS USE

for power supplies see our catalogue

LITO 1.0

①

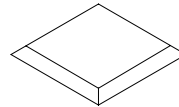

③

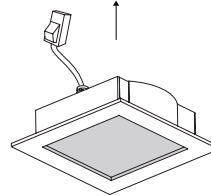

LITO 2.0

①

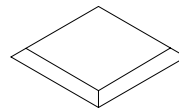

③

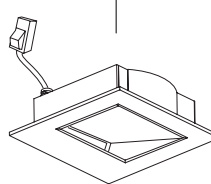

DIMENSIONS

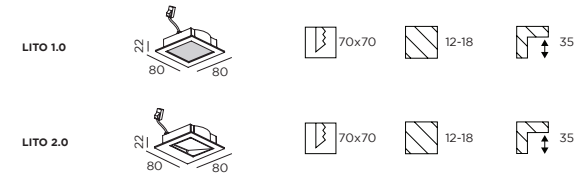

MOUNTING INSTRUCTION

- ① Make a hole in the ceiling according to the prescribed dimensions.

POWER CONNECTION

- ② SERIAL CONNECTION - for LED

**Always use POWER SUPPLY
350mA / 500mA**

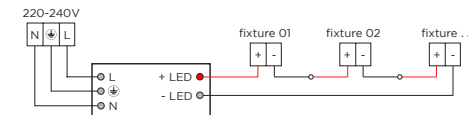

WEVER & DUCRÉ
LIGHTING

www.weverducre.com

**INSTALLATION
INSTRUCTIONS**

PAGE 1/2

LITO

WALL INSTALLATION
28-10-2015

1.0

LED 2/3W | 350-500mA | 6Vf | PCB 3-step | excl. power supply

CE IP40 960°C 0.3m 10

3000K | >85CRI | 188-260lm

white texture	145181W4
aluminium anodised	145181A4
black texture	145181B4

ALWAYS USE
for power supplies see our catalogue

OPTIONAL (when using recessed housing, ALWAYS use plaster kit too)

plaster kit	90017103
recessed housing (always use in combination with plaster kit 90017103)	90012031

2.0

LED 2/3W | 350-500mA | 6Vf | PCB 3-step | excl. power supply

CE IP40 960°C 0.3m 10

3000K | >85CRI | 188-260lm

white texture	145281W4
aluminium anodised	145281A4
black texture	145281B4

ALWAYS USE
for power supplies see our catalogue

OPTIONAL (when using recessed housing, ALWAYS use plaster kit too)

plaster kit	90017103
recessed housing (always use in combination with plaster kit 90017103)	90012031

plaster kit
90017103 (OPTIONAL)

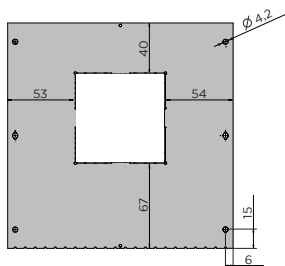
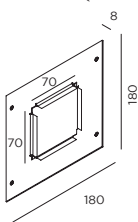

recessed housing (always use in combination with plaster kit)

90012031 (OPTIONAL)

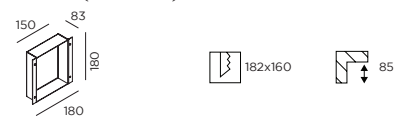

standard

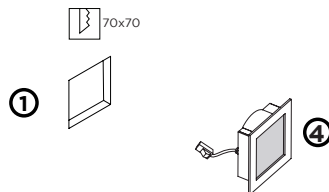

only with plaster kit

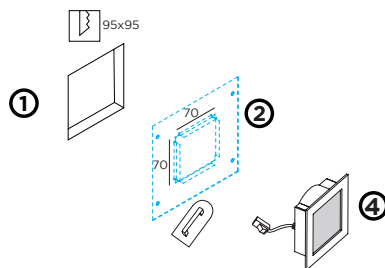

recessed housing + plaster kit

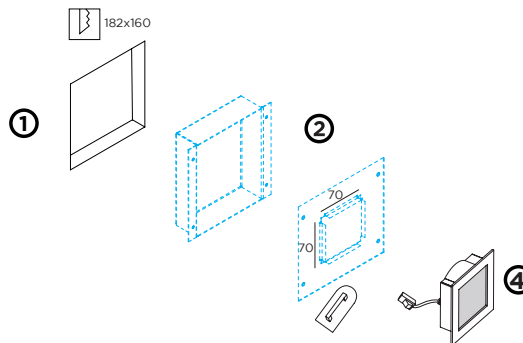

DIMENSIONS



MOUNTING INSTRUCTION

- 1 Make a hole in the wall according to the prescribed dimensions of the fixture or the recessed housing.
- 2 When using a (recessed housing +) plaster kit: Insert the recessed housing into the wall and fix the plaster kit with screws on it. Plaster into the wall.

POWER CONNECTION

- 3 SERIAL CONNECTION - for LED

**Always use POWER SUPPLY
350mA / 500mA**

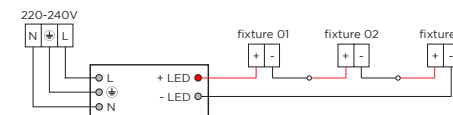

- 4 Insert the fixture in the hole or recessed housing



WEVER & DUCRÉ
LIGHTING

www.weverducre.com

**INSTALLATION
INSTRUCTIONS**
PAGE 2/2