

AMISOL

design Daniel Ribakken

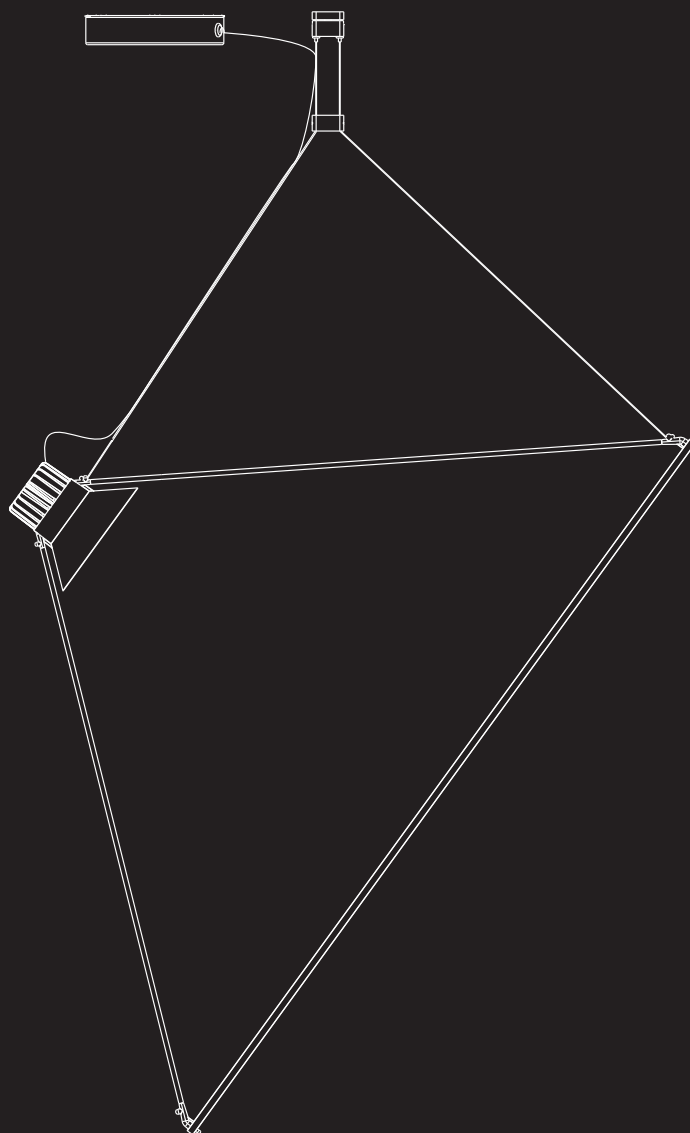

**LUCE
PLAN**

D91



D91

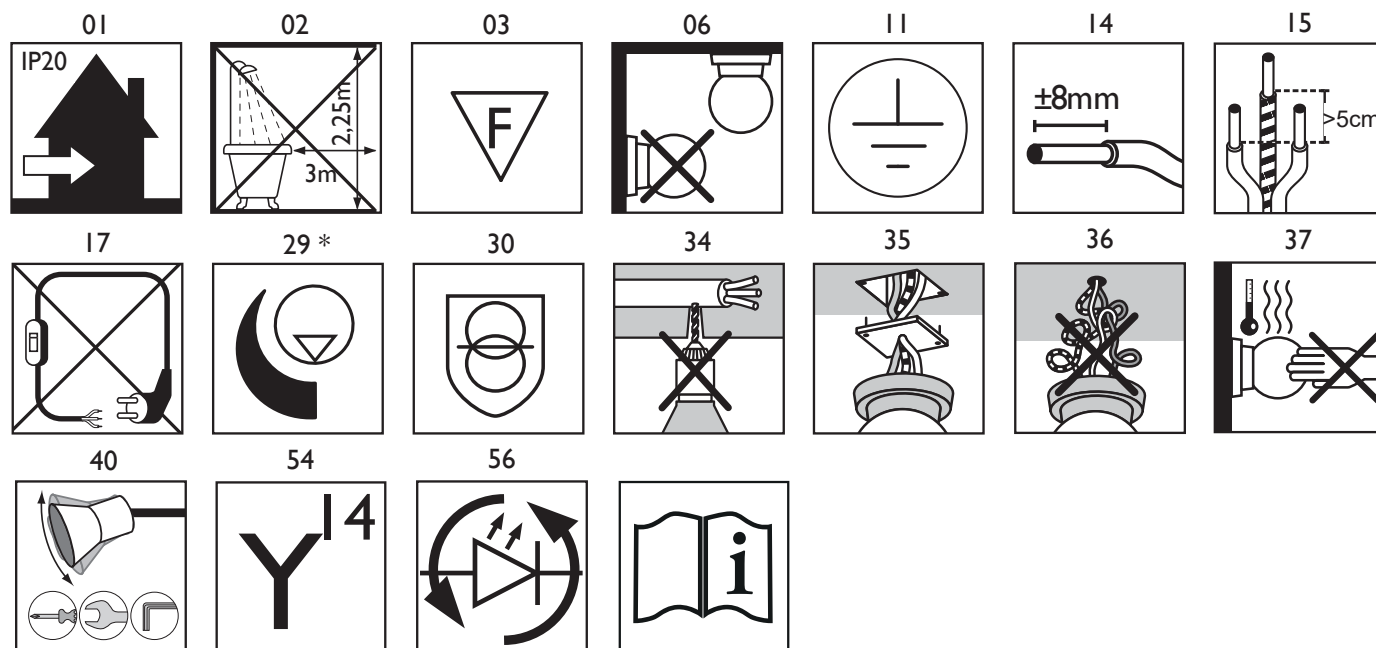

29* Amisol drivers are suitable for use with DALI - Push dimm

D91s
D91/1

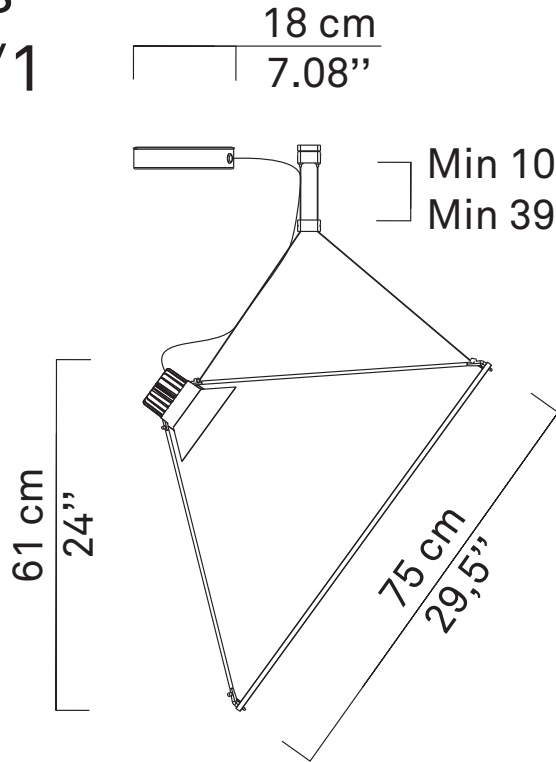

a



b

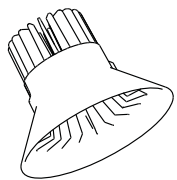
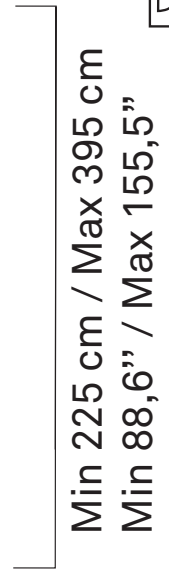

x1

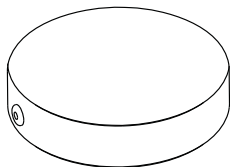

x1

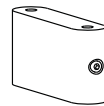

x1

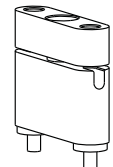

x1

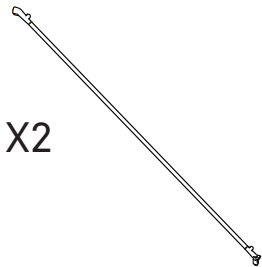

x2

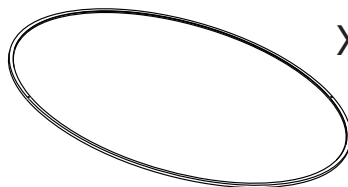

x1



x2

(3 m - 118")

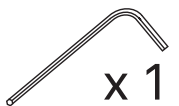

x1



x4



x4



x2



x2



x1

kg 2.5 kg

lb 5.51 lb

D91s
D91/2

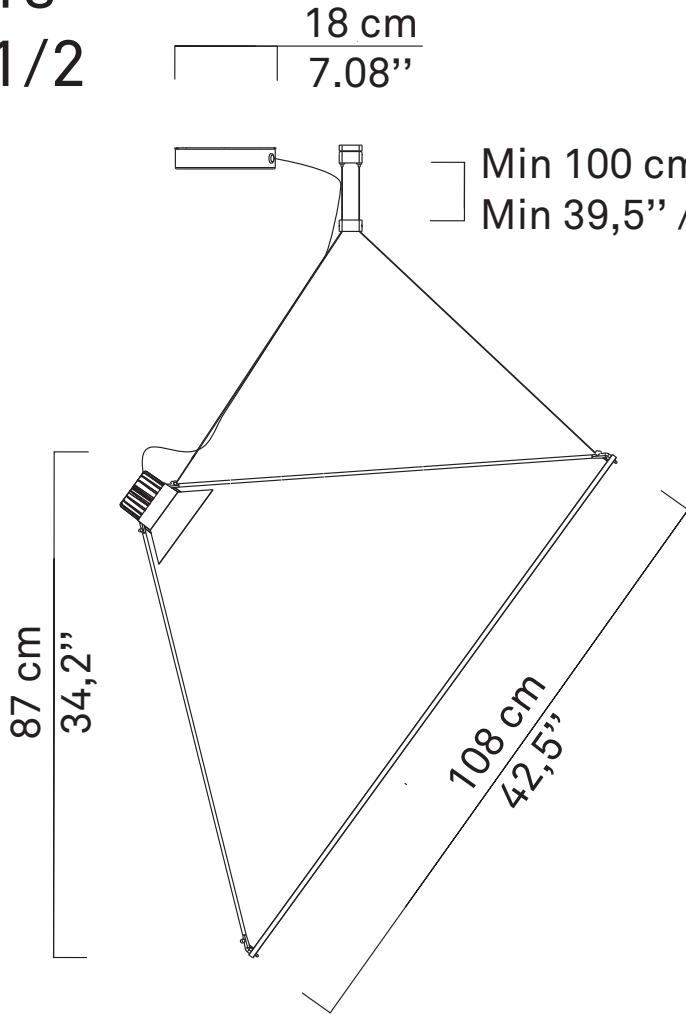

Min 300 cm / Max 420 cm
Min 118" / Max 165,3"

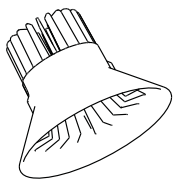

x1

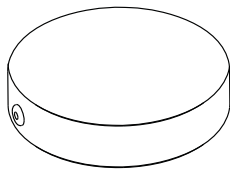

x1

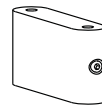

x1

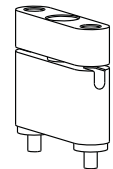

x1

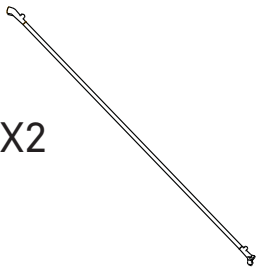

x2

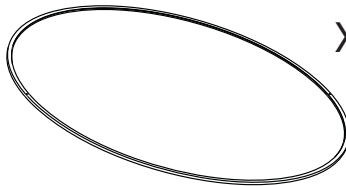

x1



x2

(3 m - 118")



x1

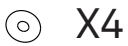

x4



x4



x2



x2



x1

kg 3.05 kg **lb** 6.72 lb

1

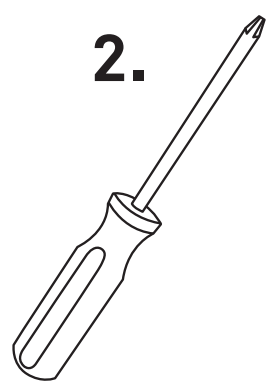
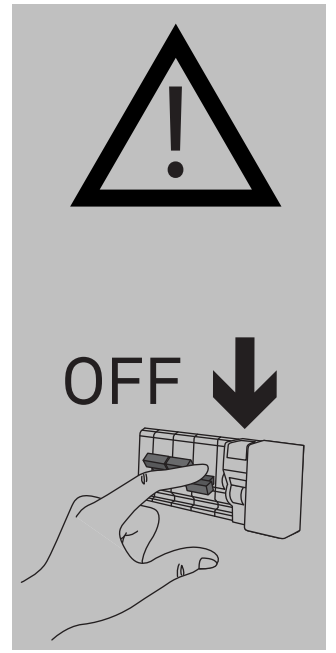
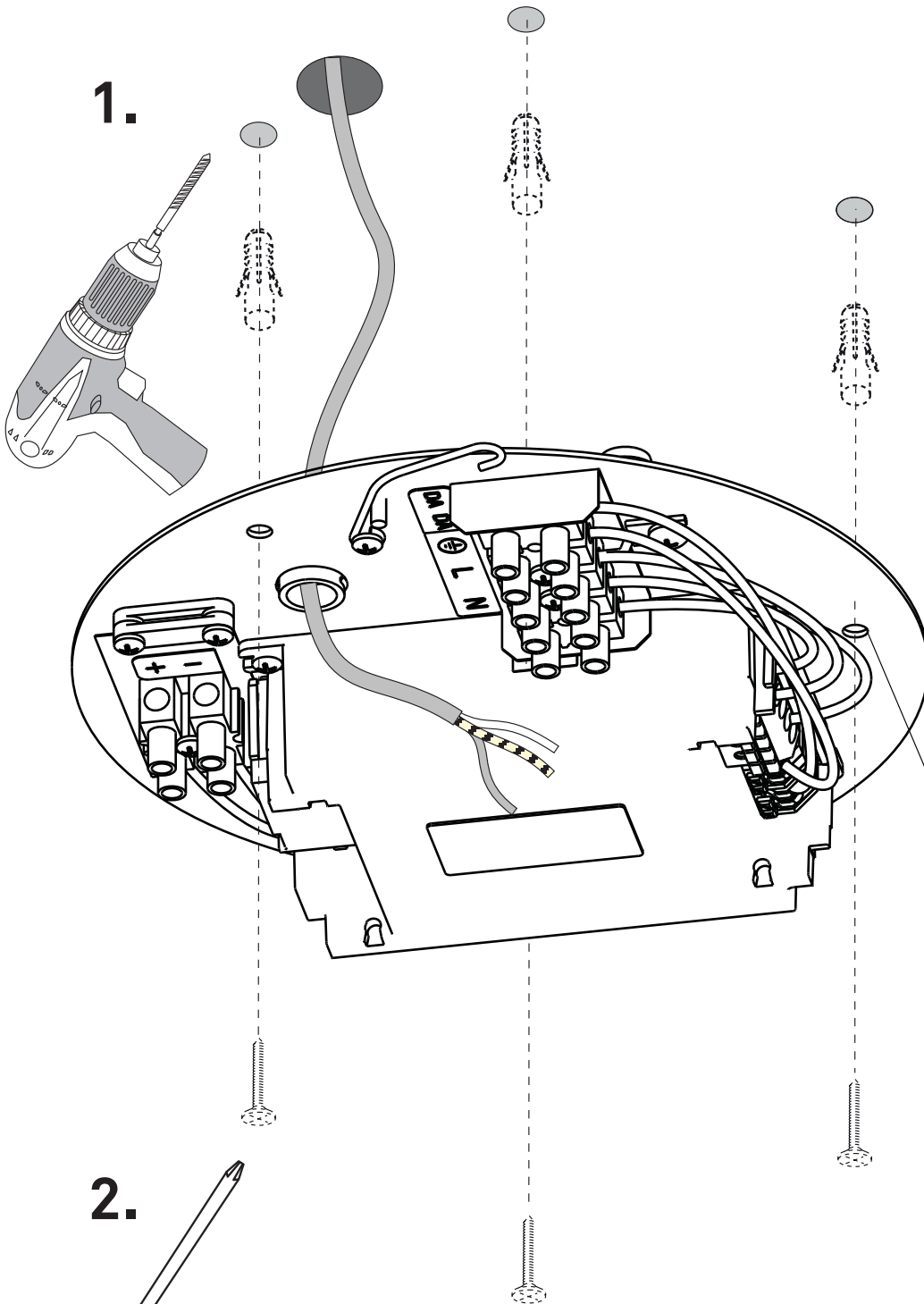

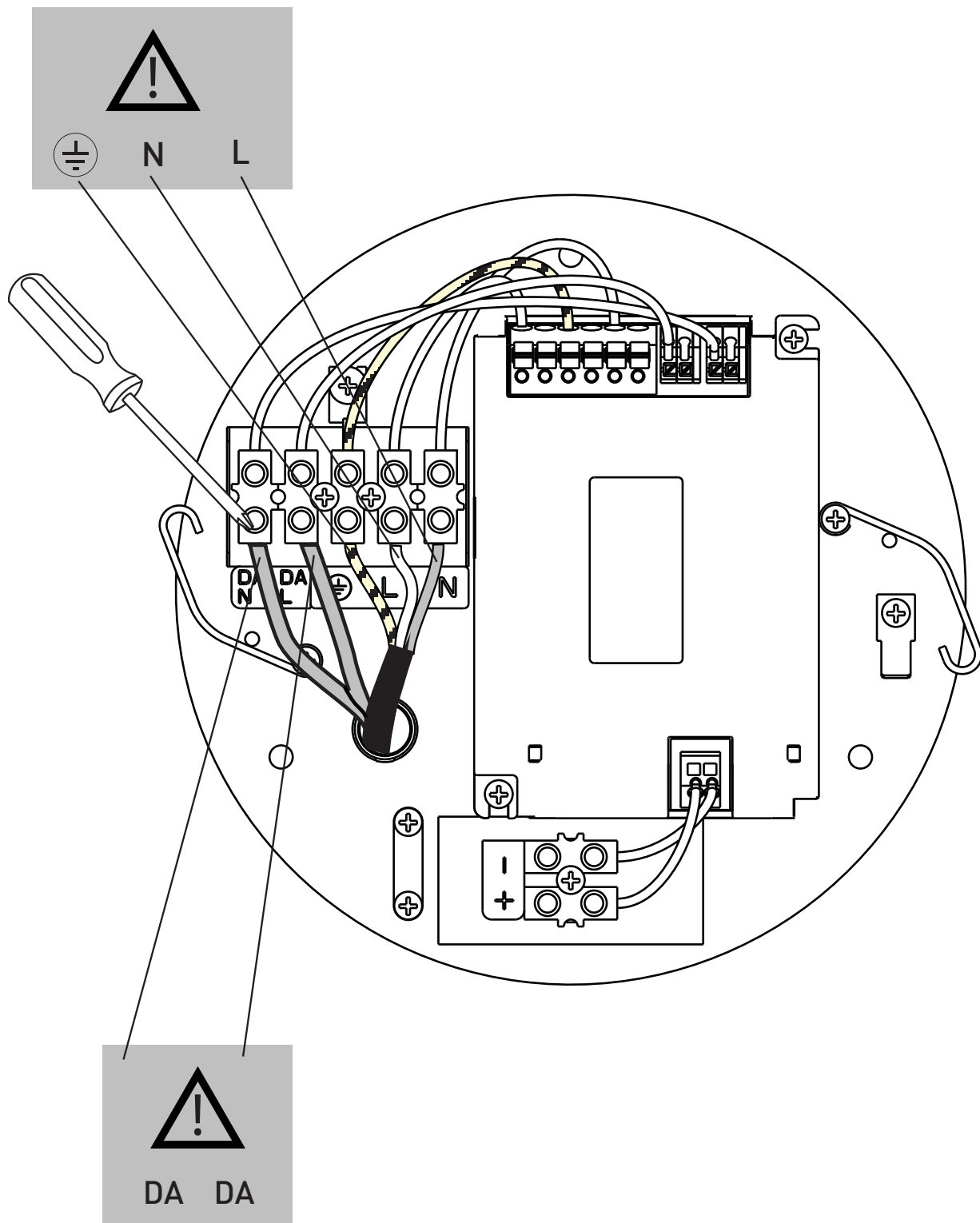
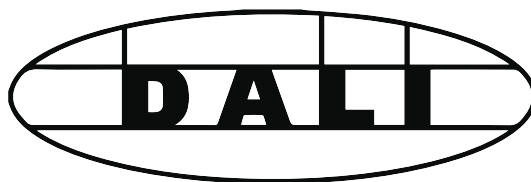

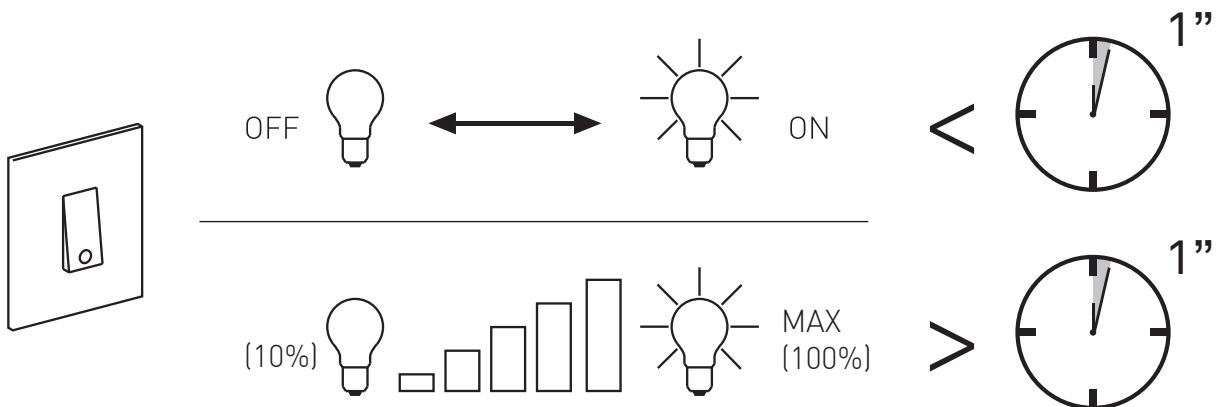
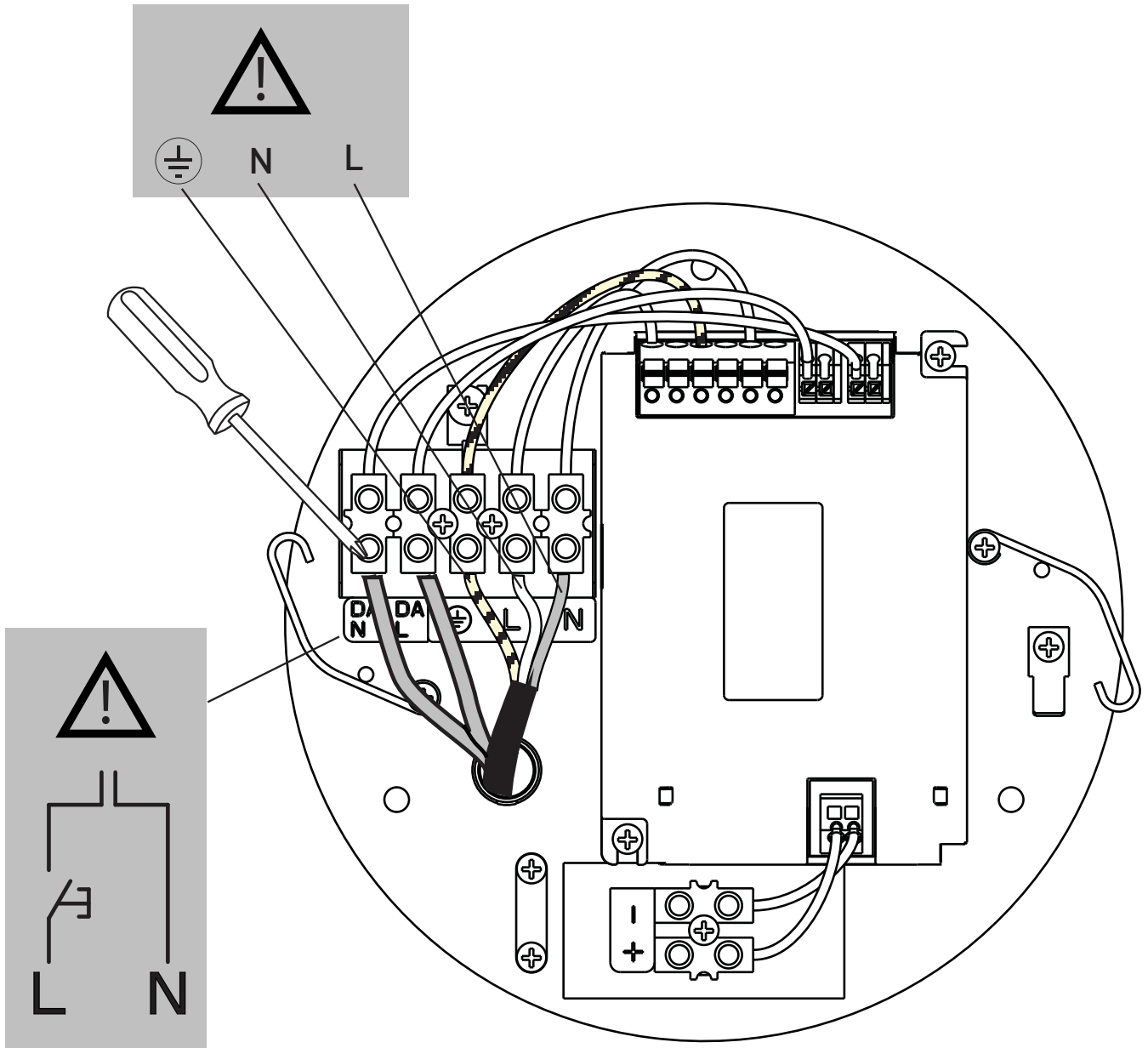

2

1.

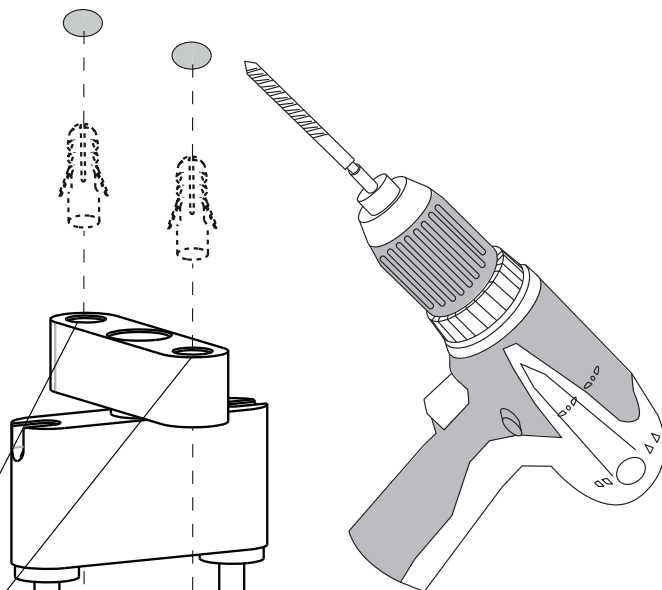
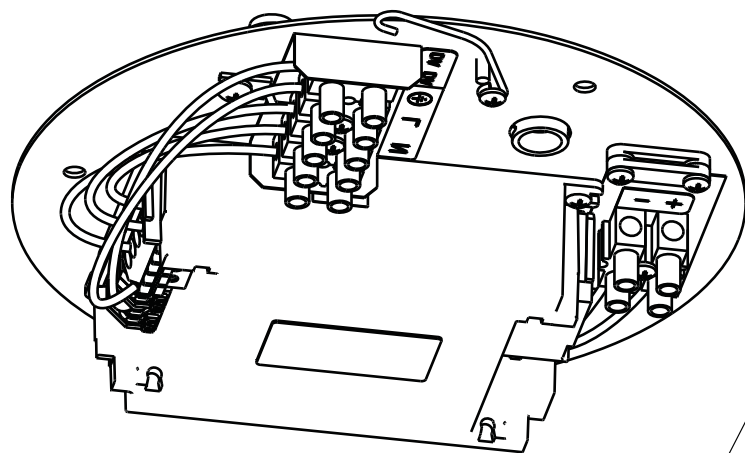

Ø 5mm
Ø 0,19"

2.

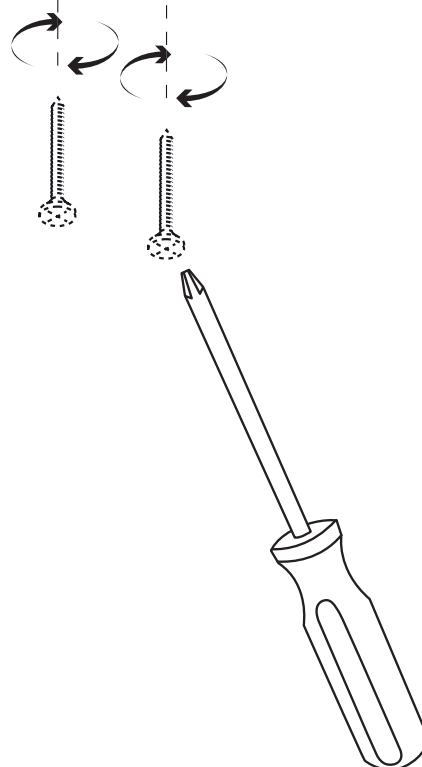

3

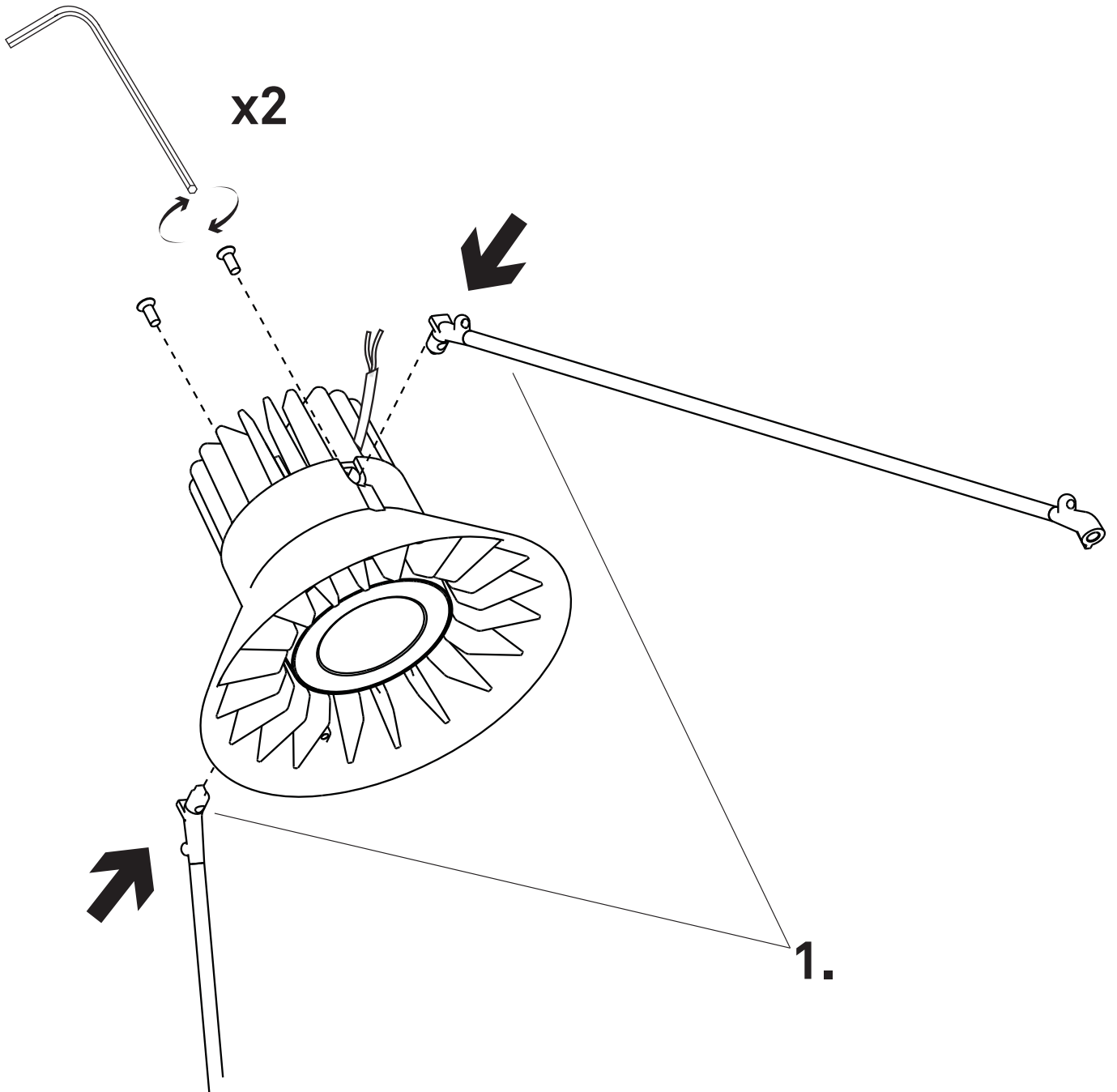

4



x 2 

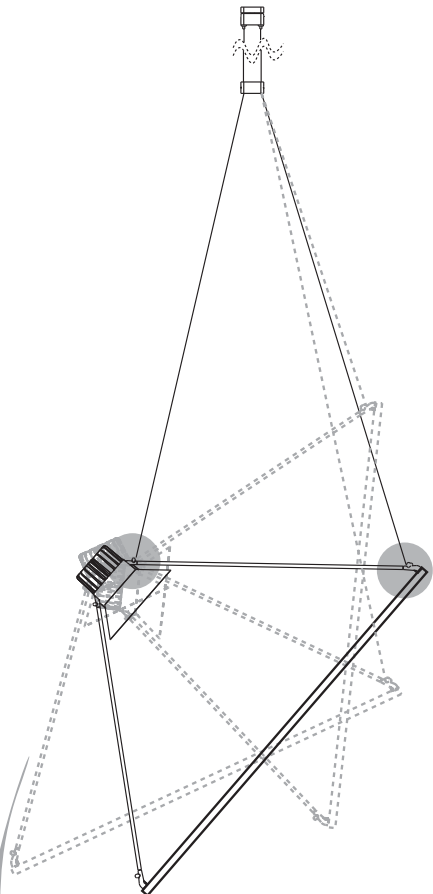
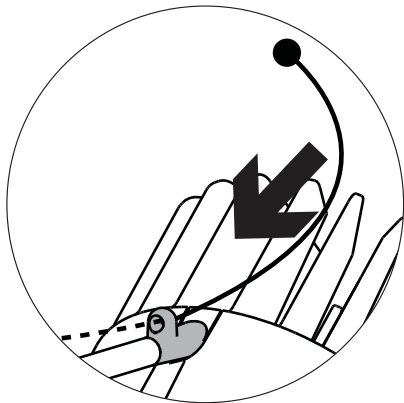
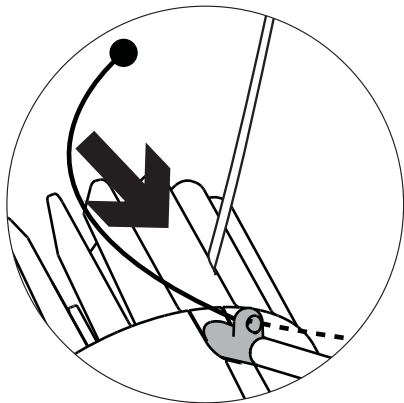

x 2 

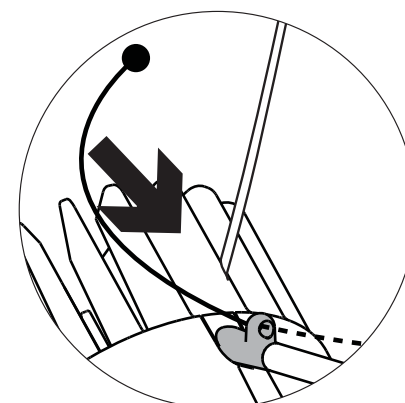
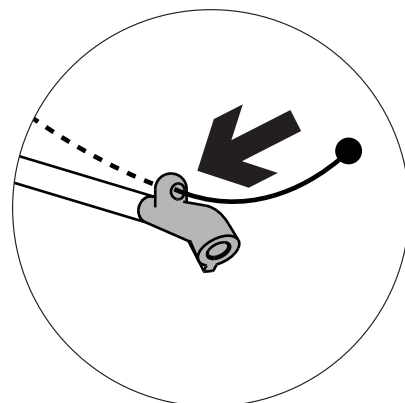

4.1

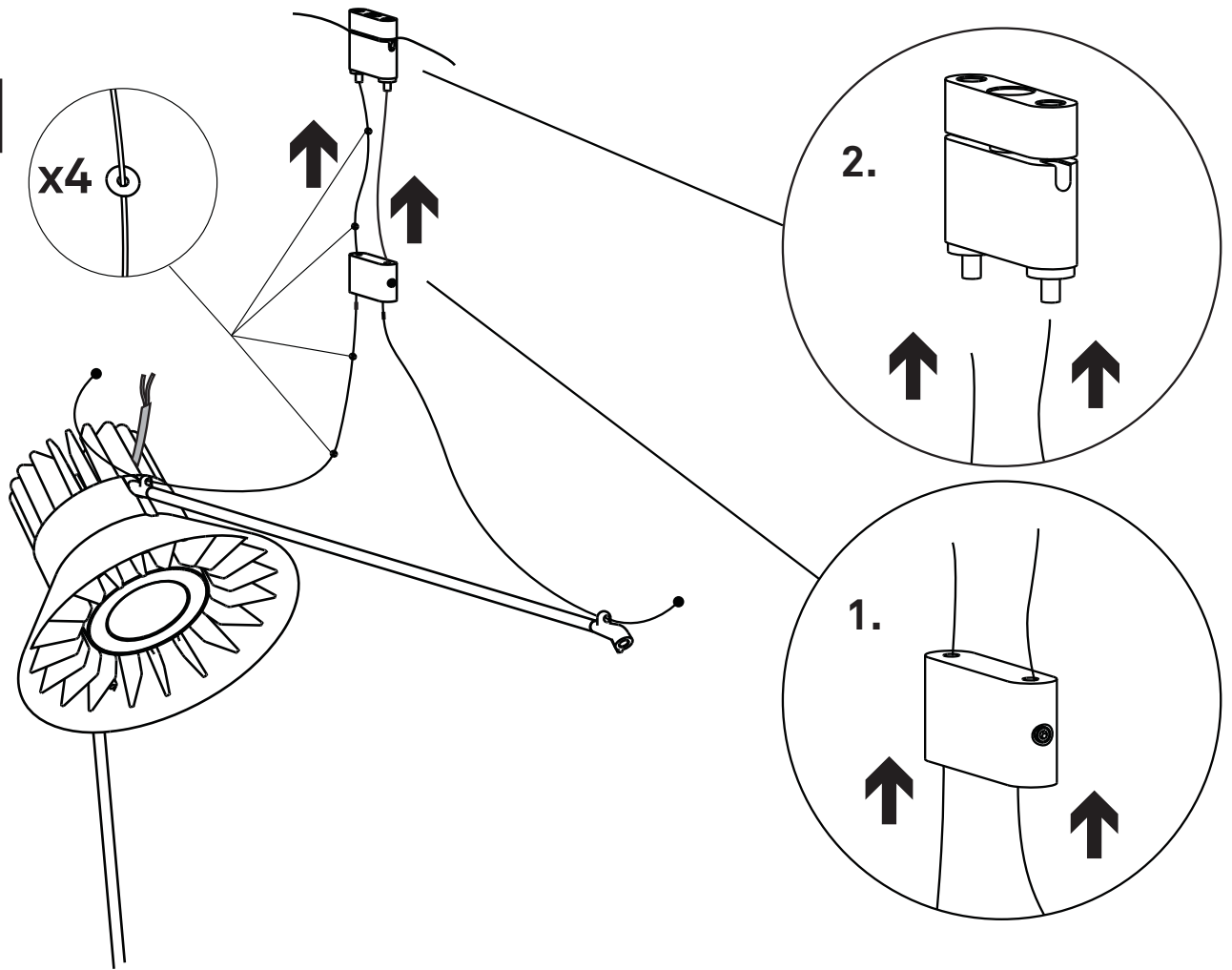

4.2

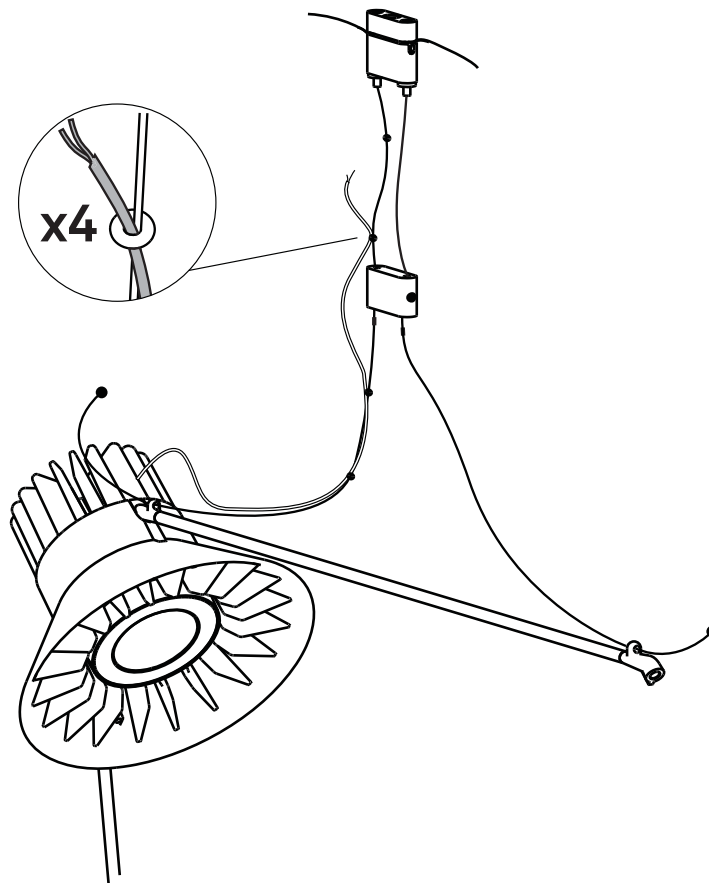

4.3

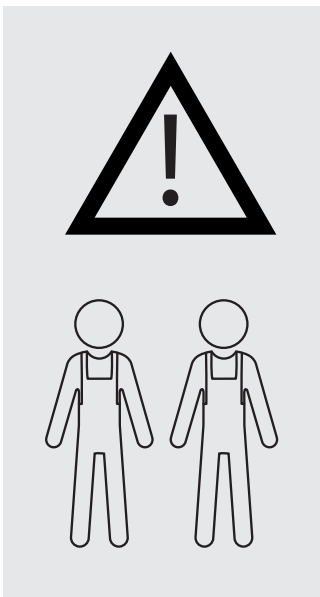
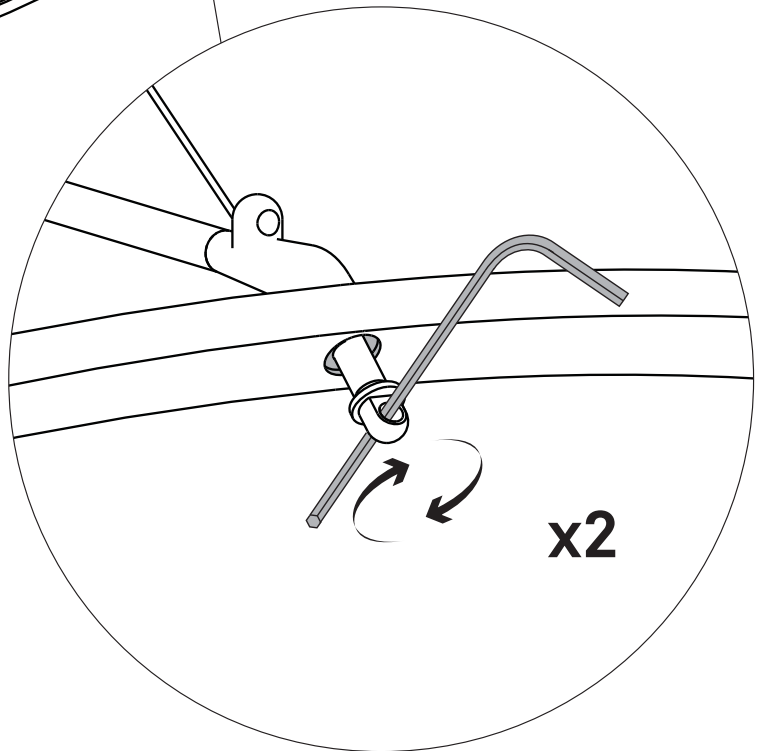
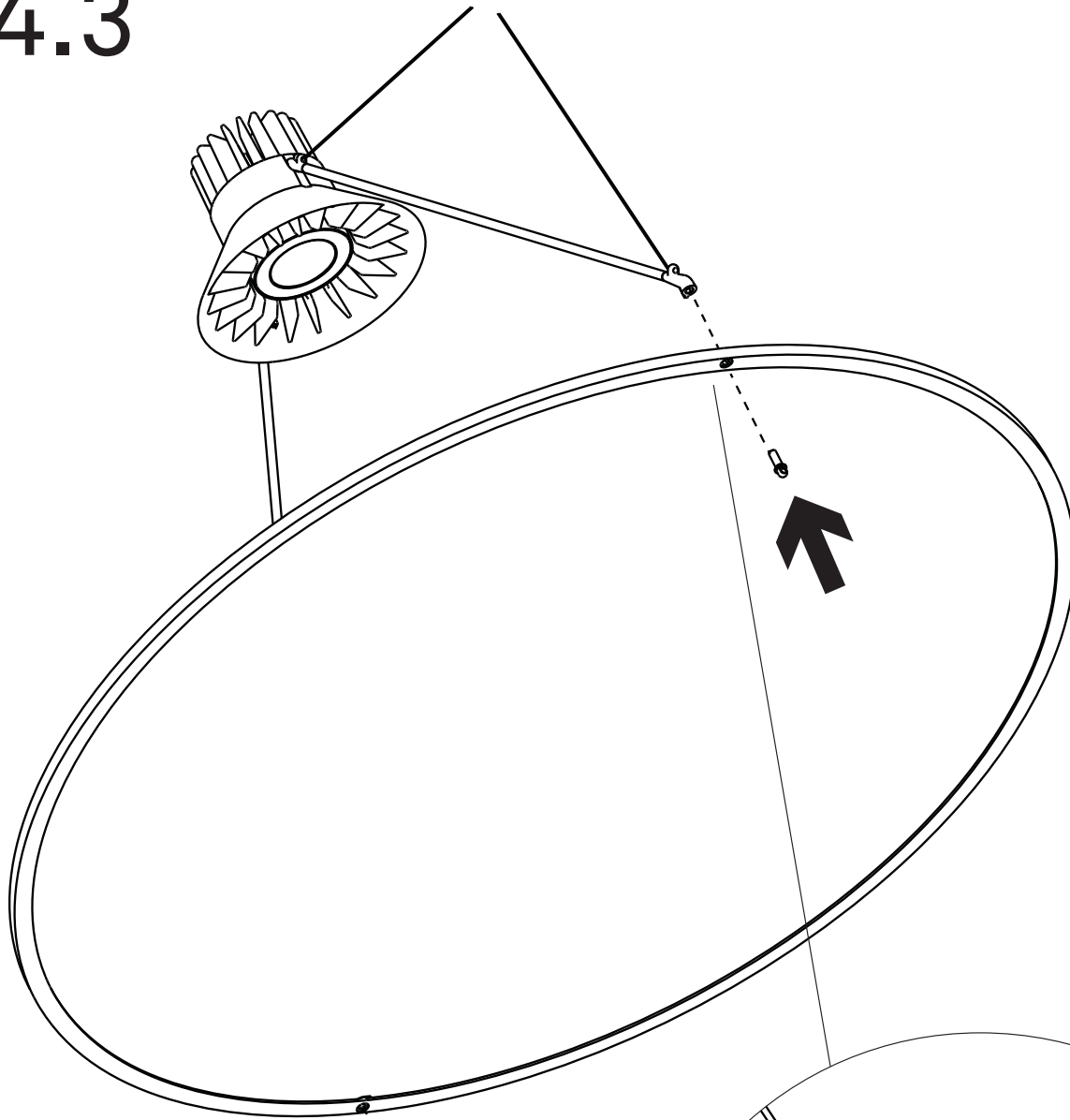

4.4

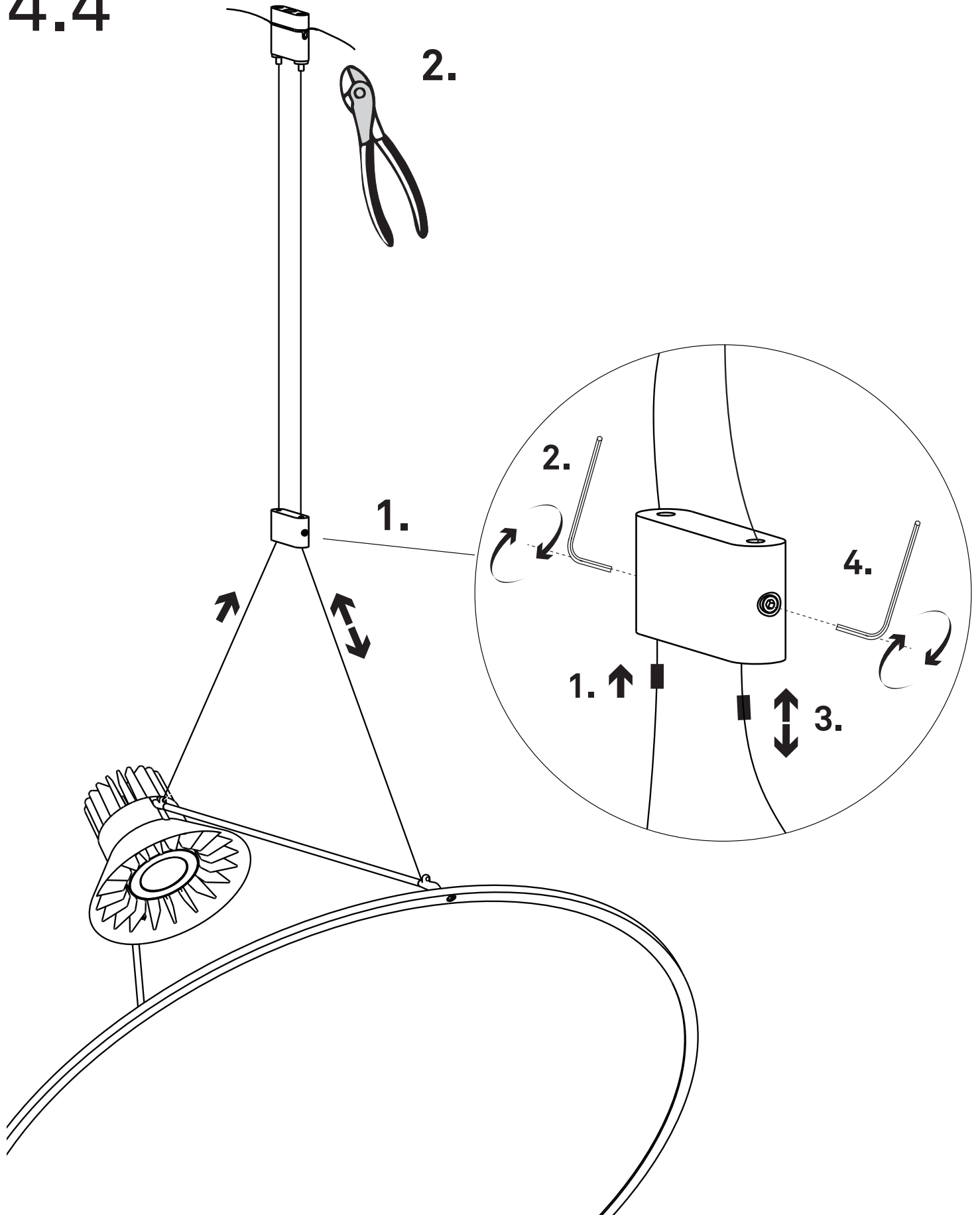

5

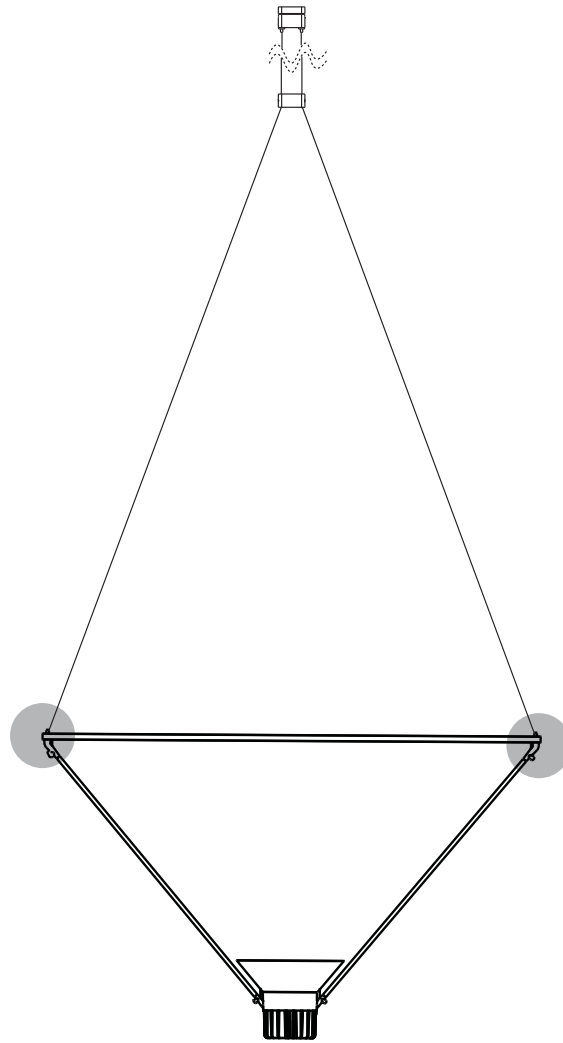

x 2

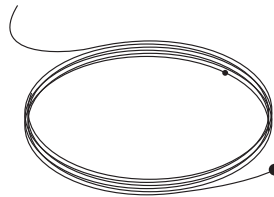

3

5.1

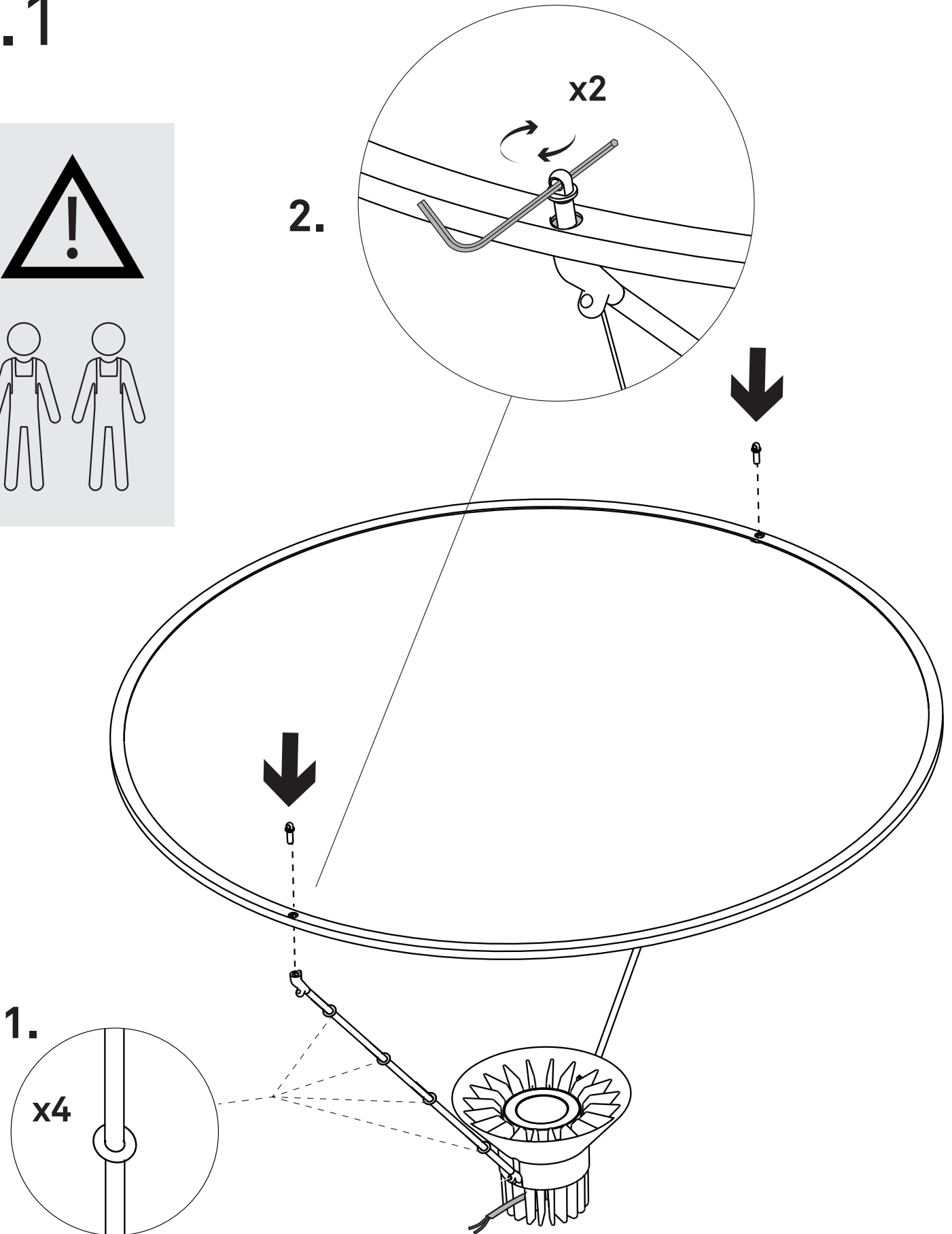
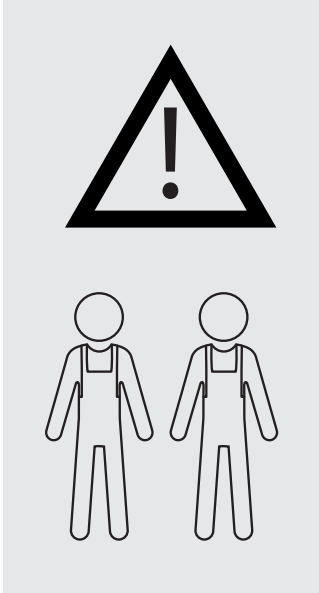

5.2

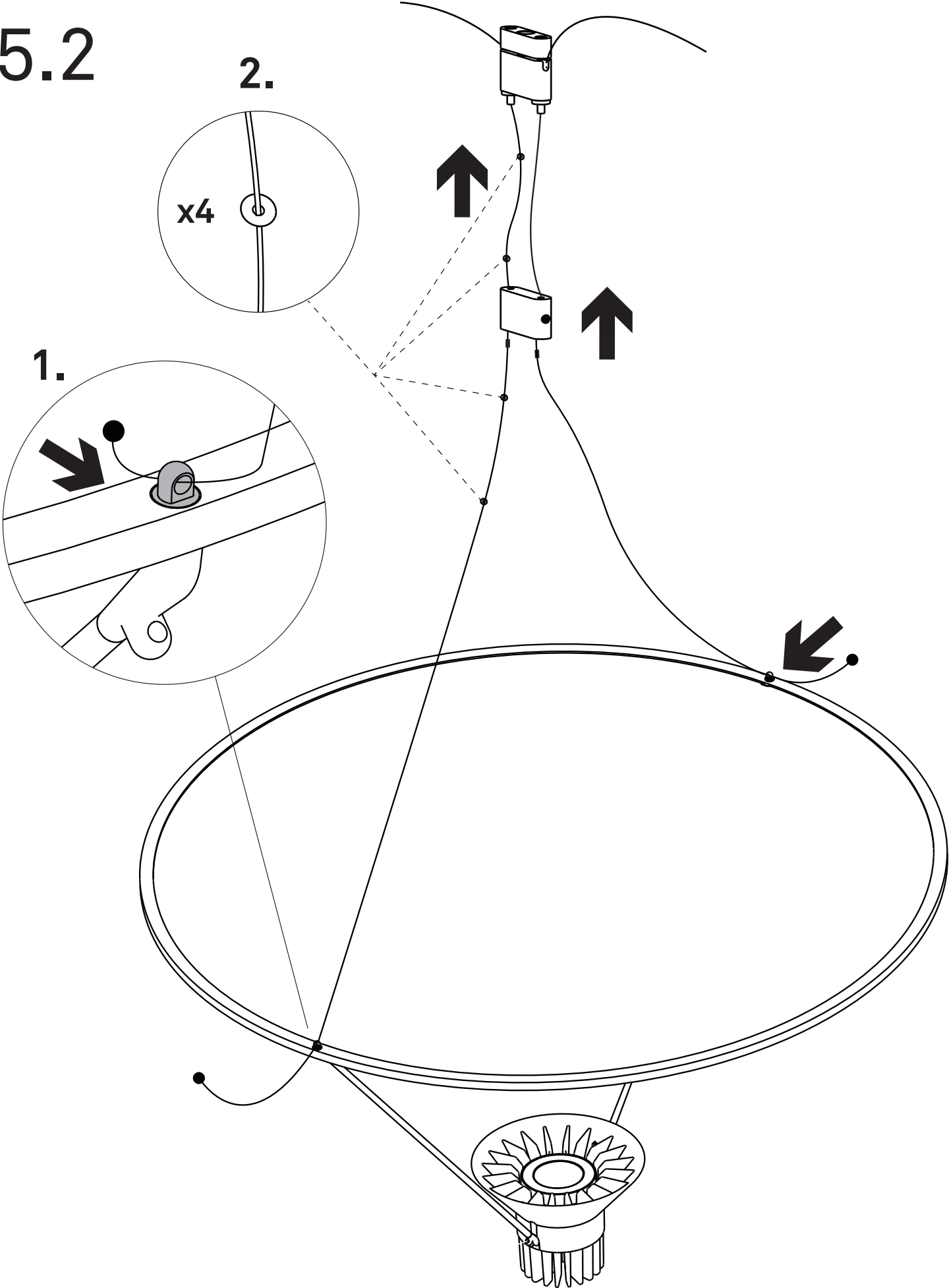

5.3

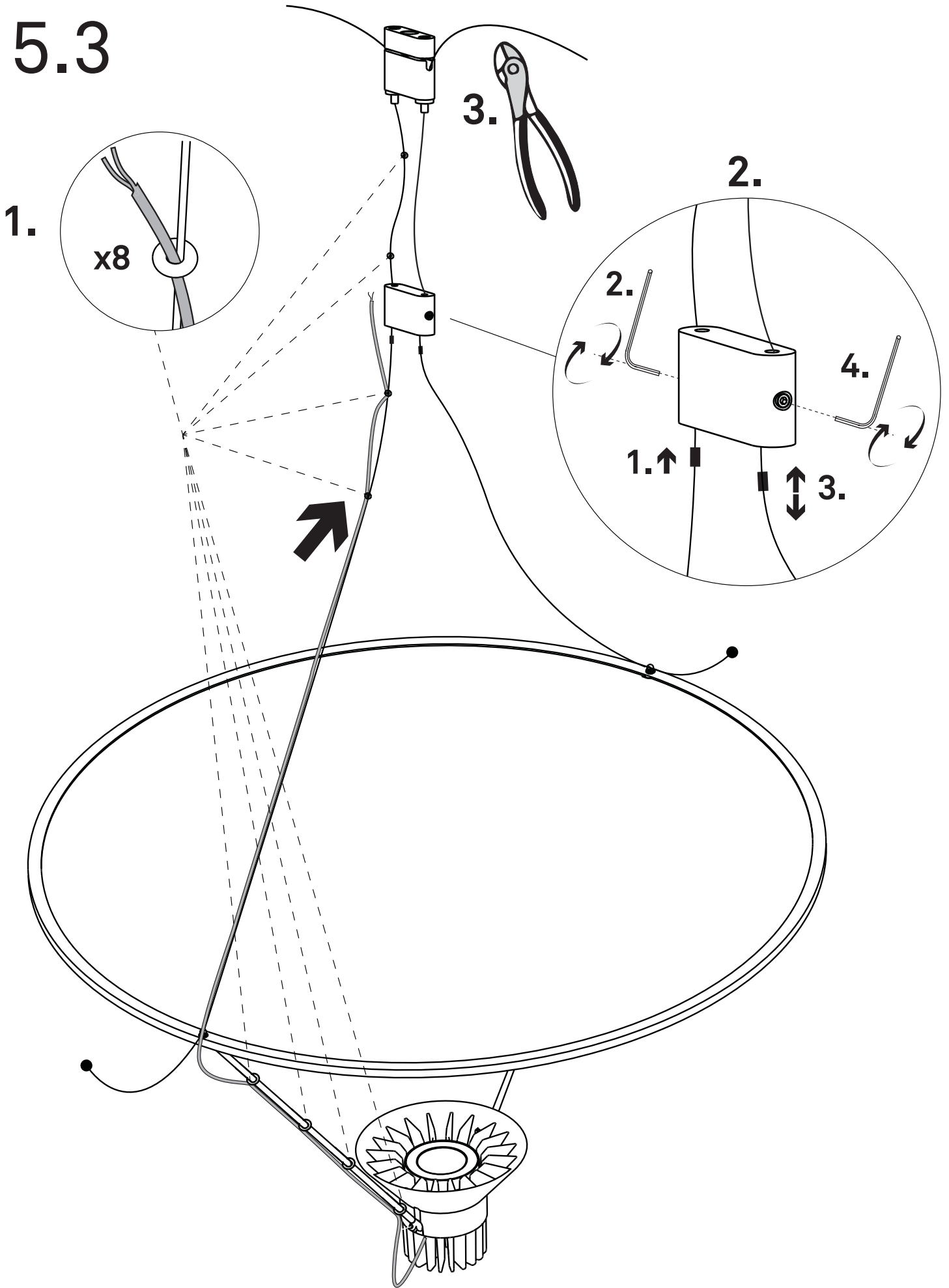

6

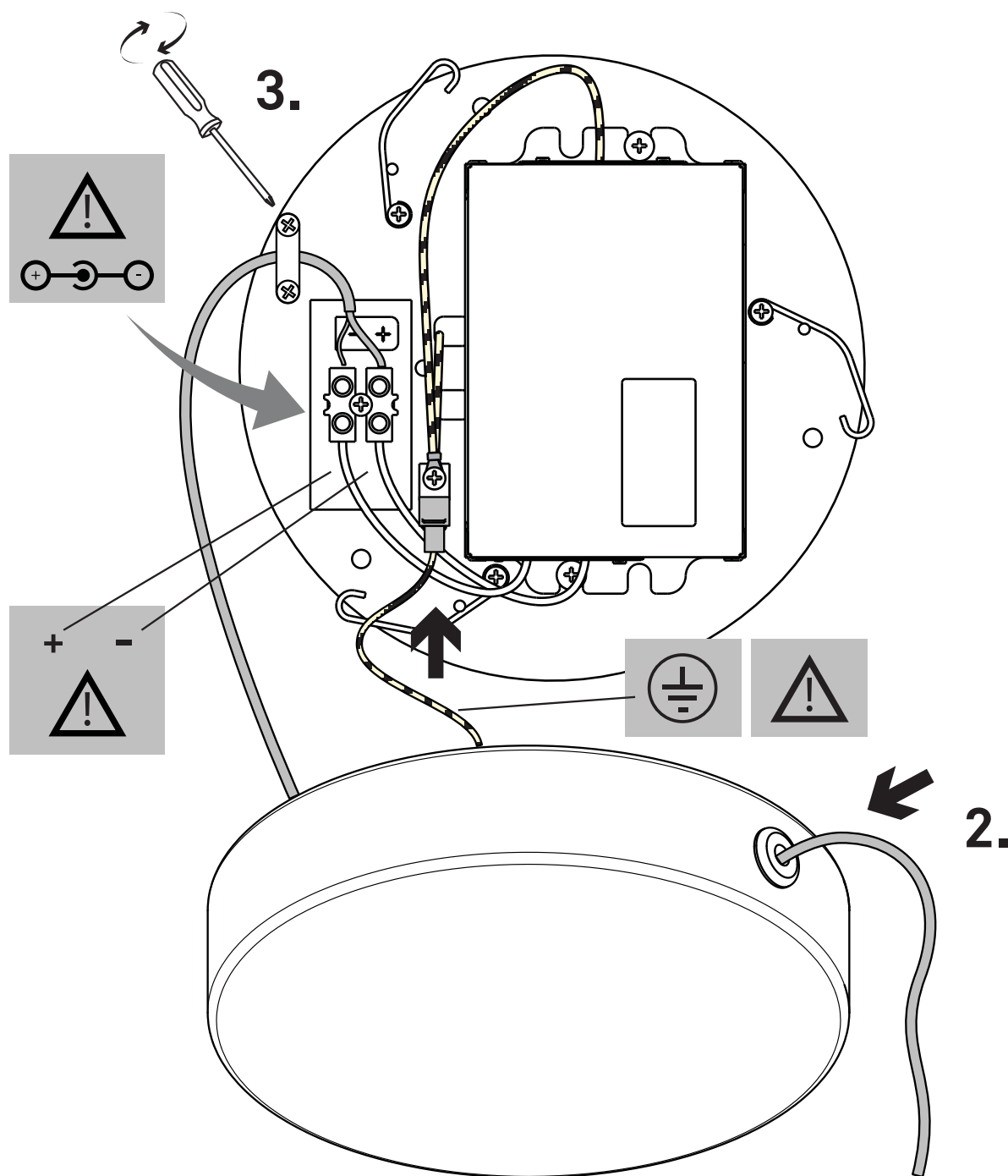
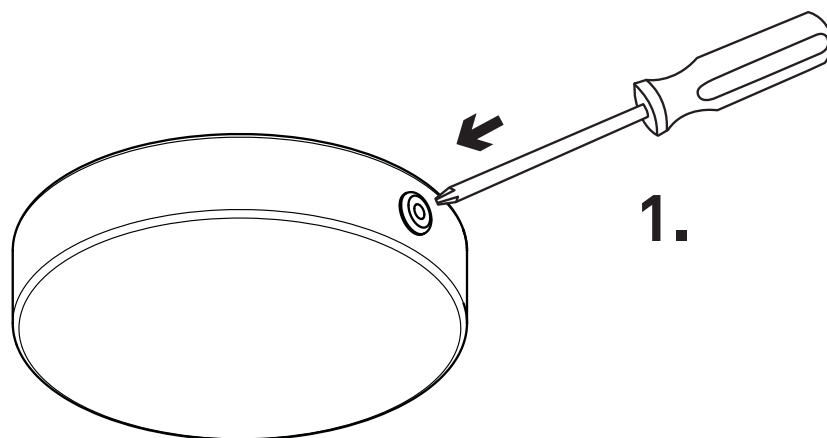

6.1

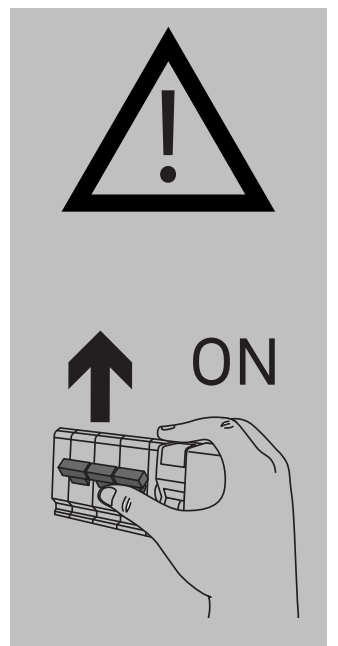
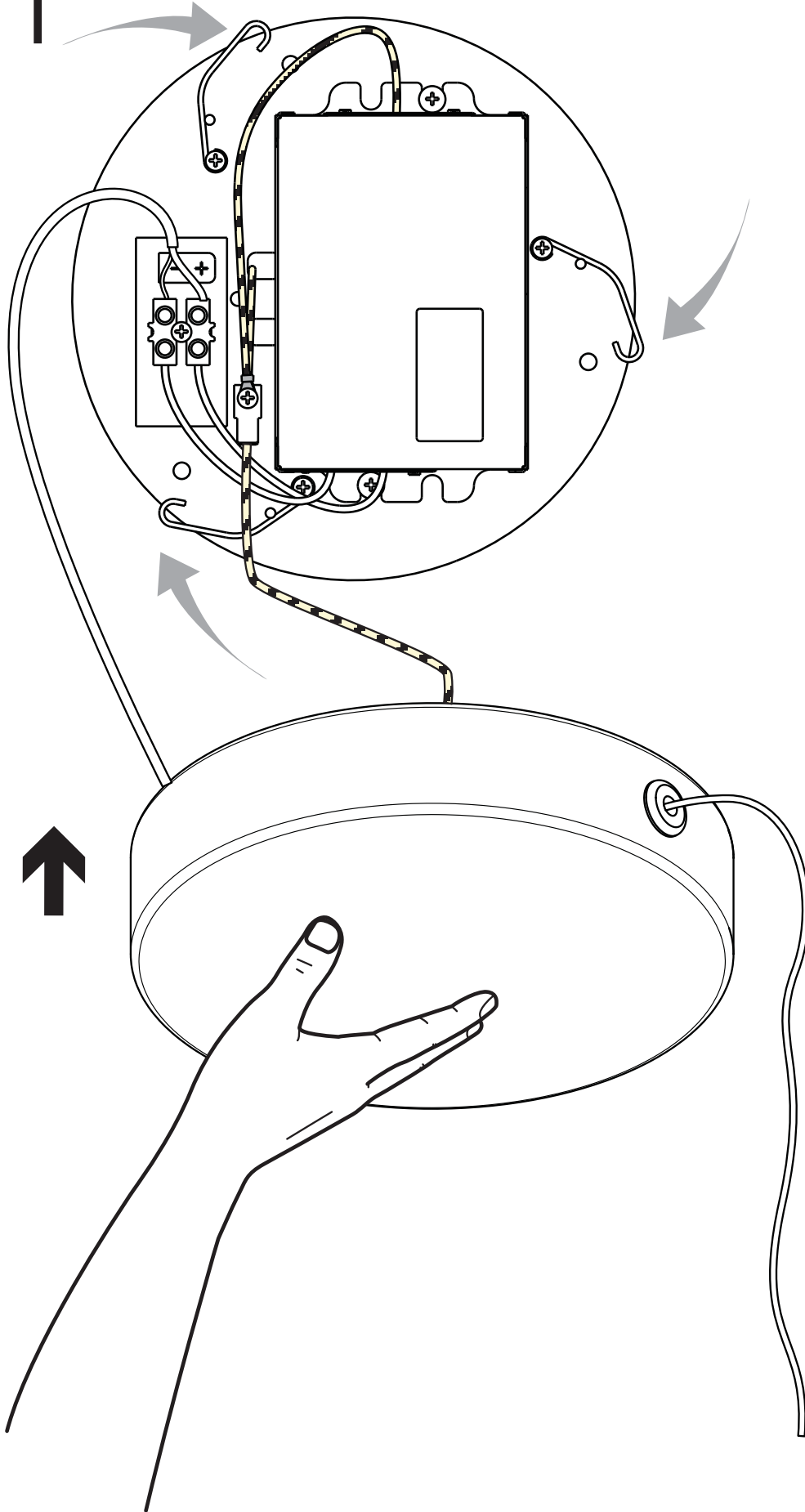

7



1D910/100020
1D910/100030
1D910/200020
1D910/200030

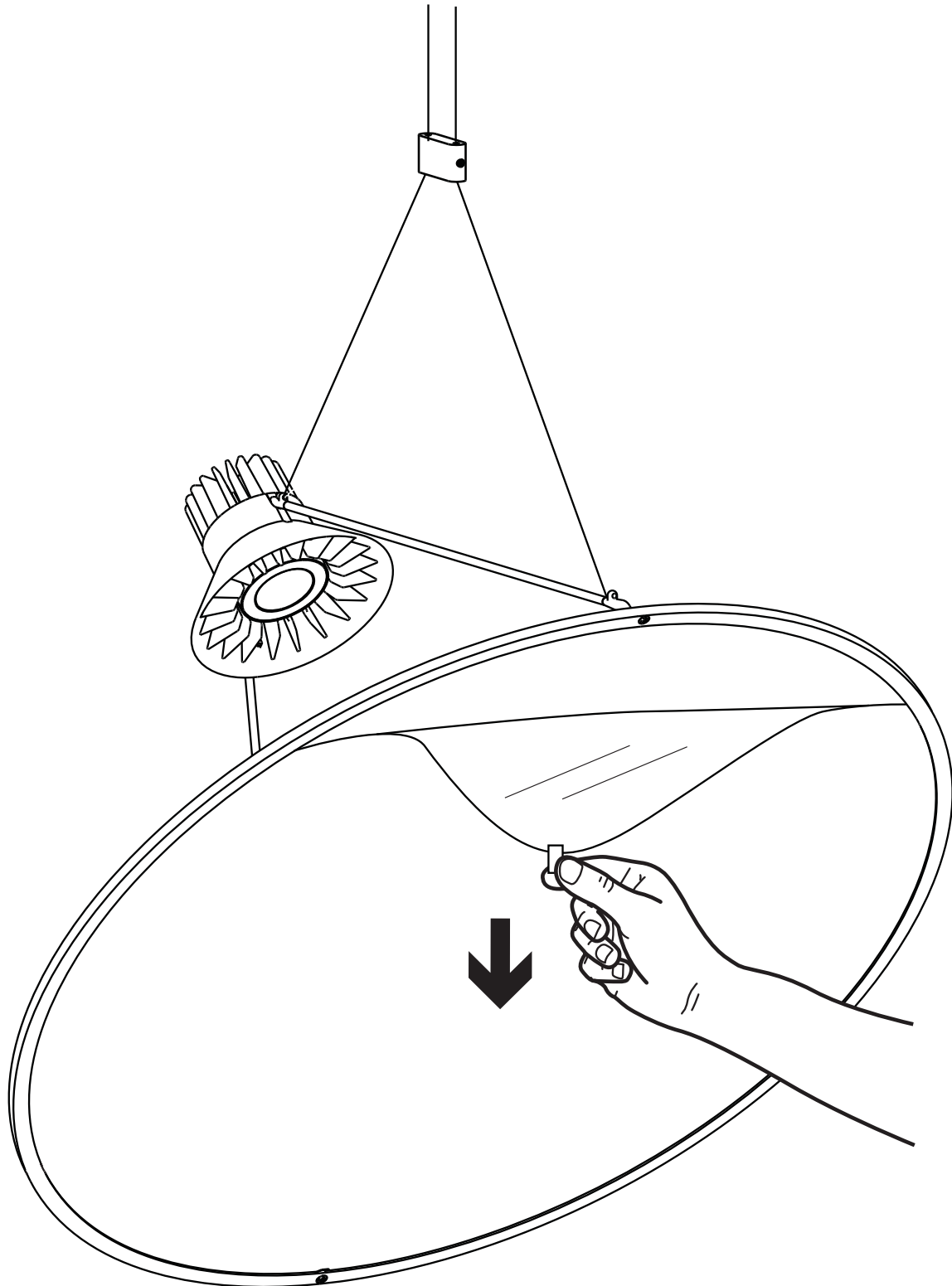

8

D91/0AAR +
D91s
D91/1
D91/2

D91/1
49 cm/19,3"

D91/2
75 cm/29,5"

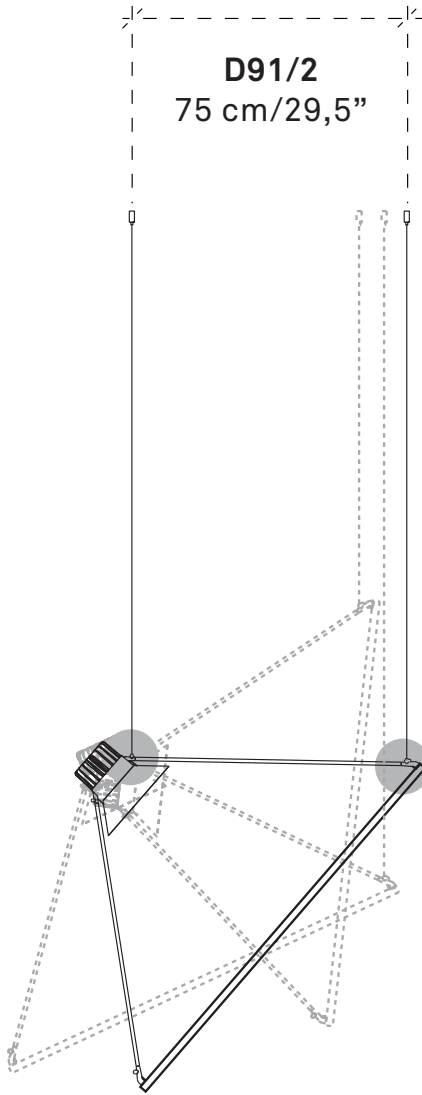

D91/1
75 cm/29,5"

D91/2
108 cm/42,5"

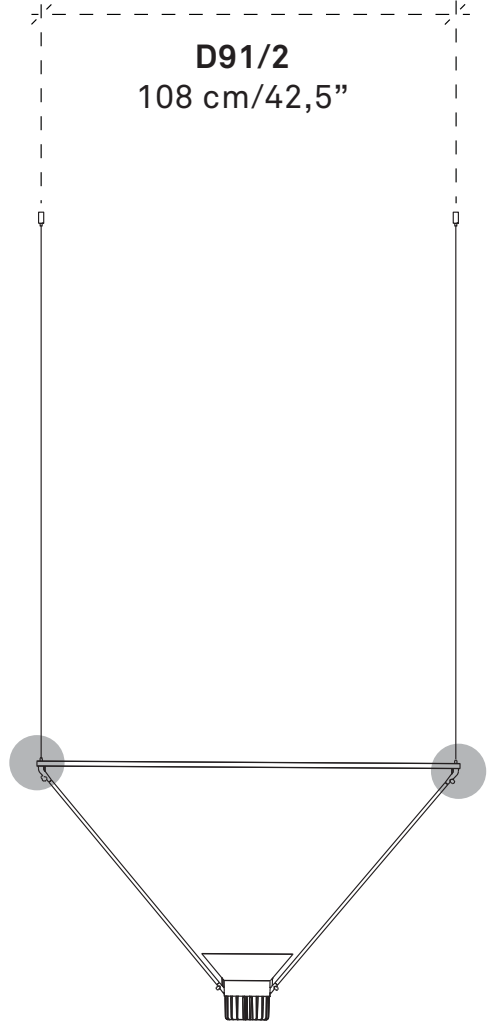

➔ **3**

9

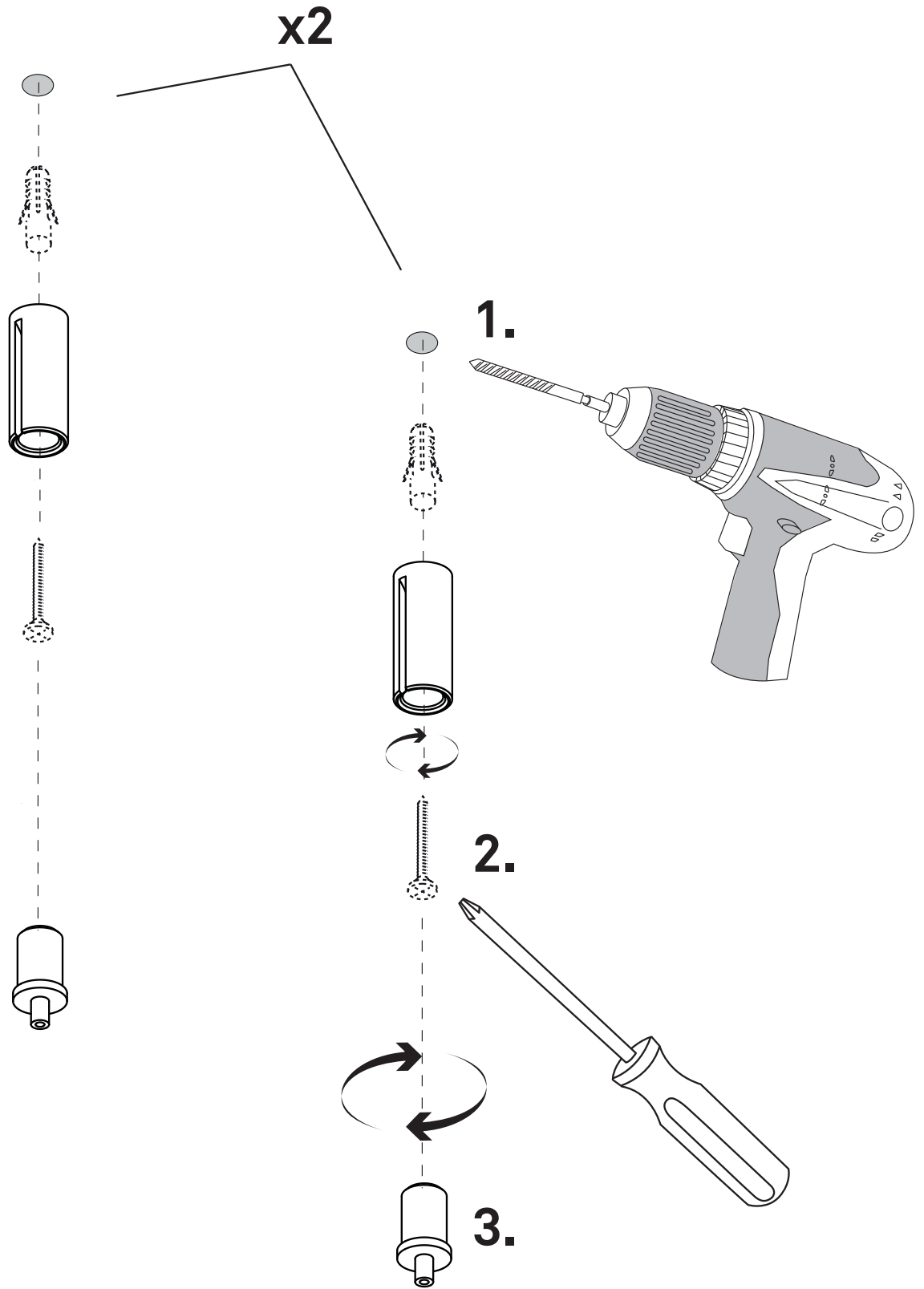

10

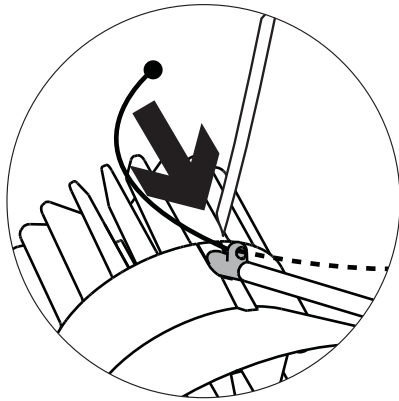
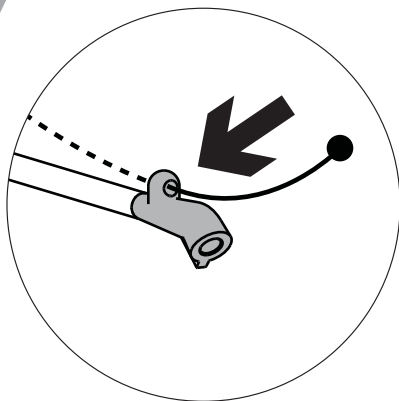
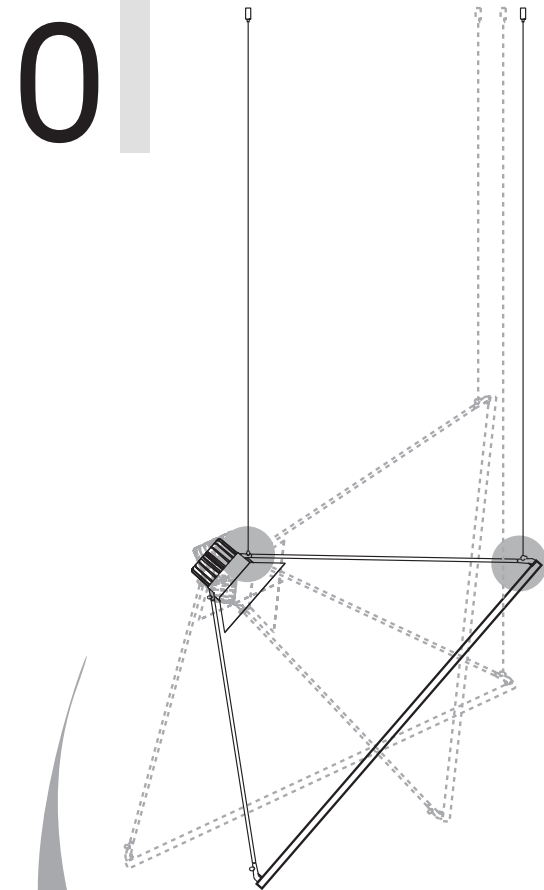

→ 1

→ 4.3

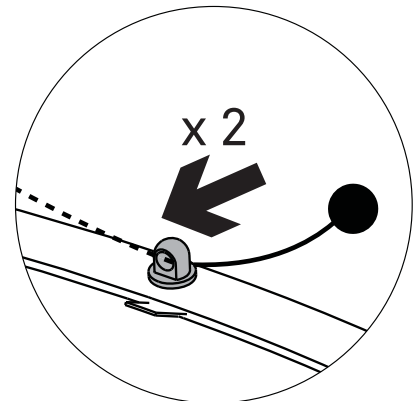
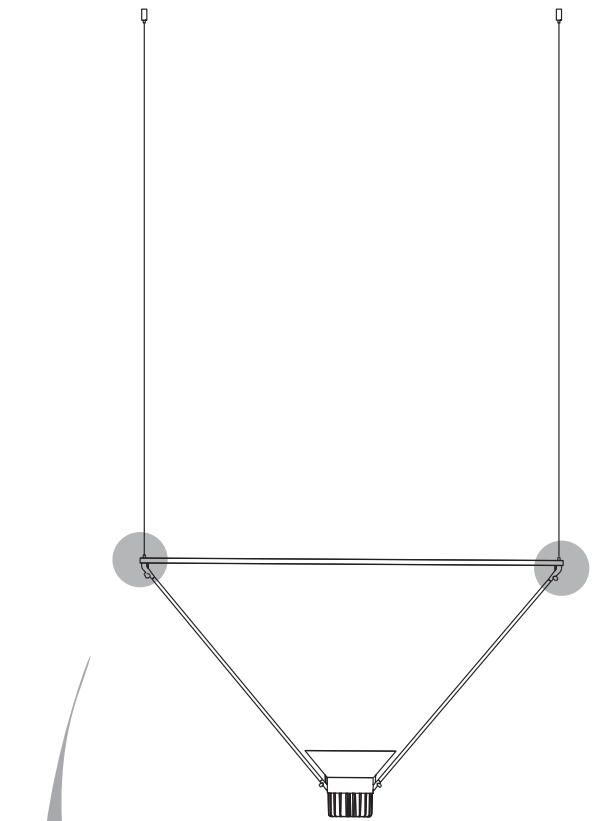

→ 1

→ 5.1

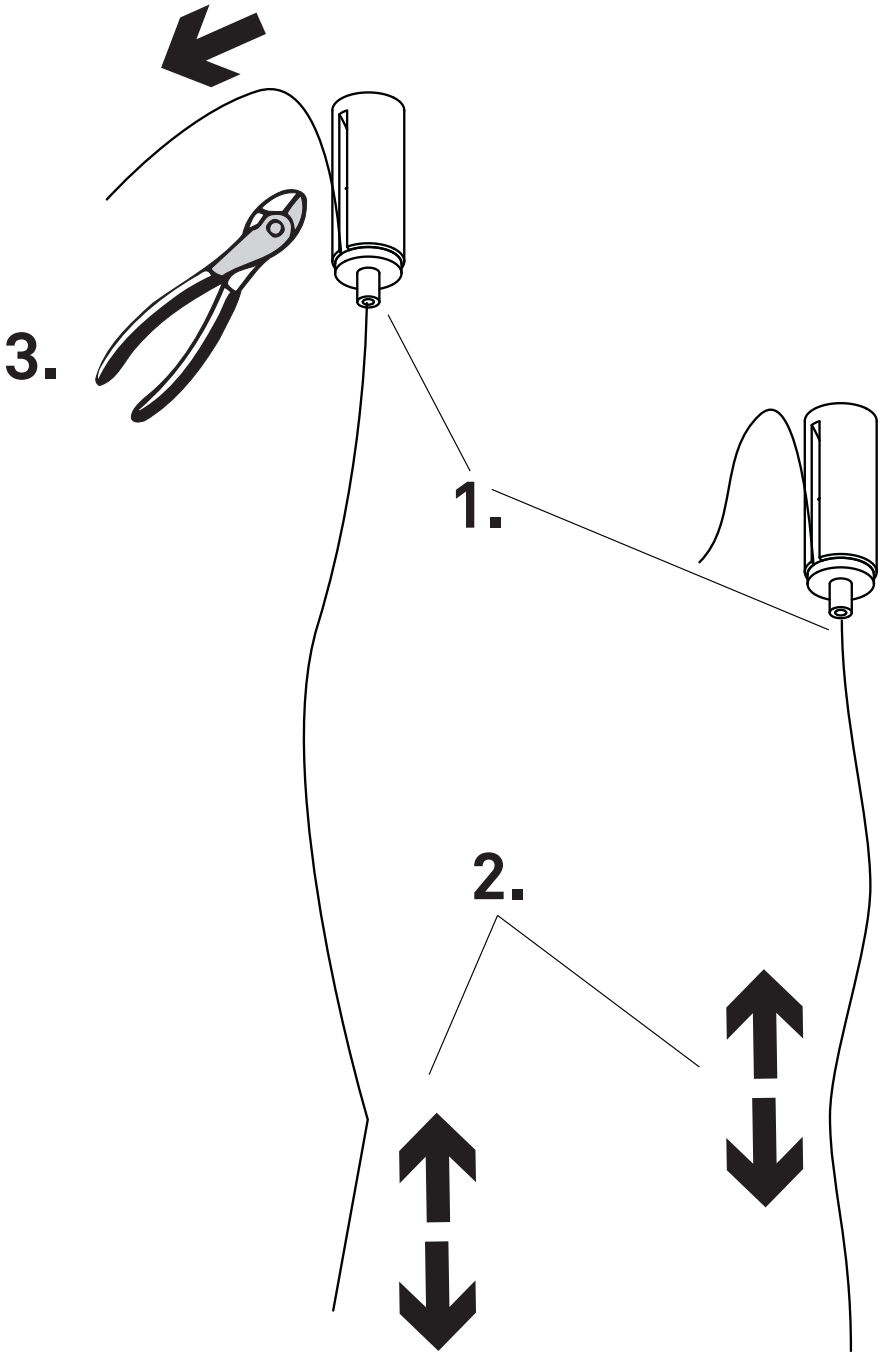

→6 | →6.1 | →7 |

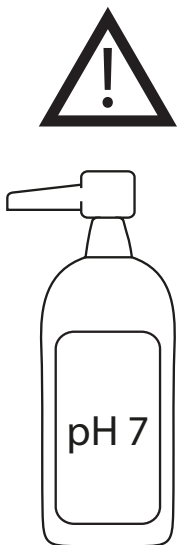
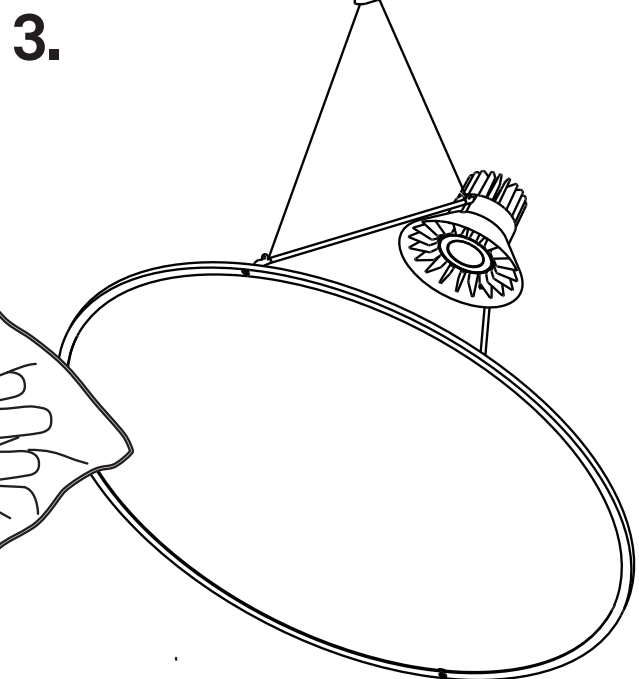
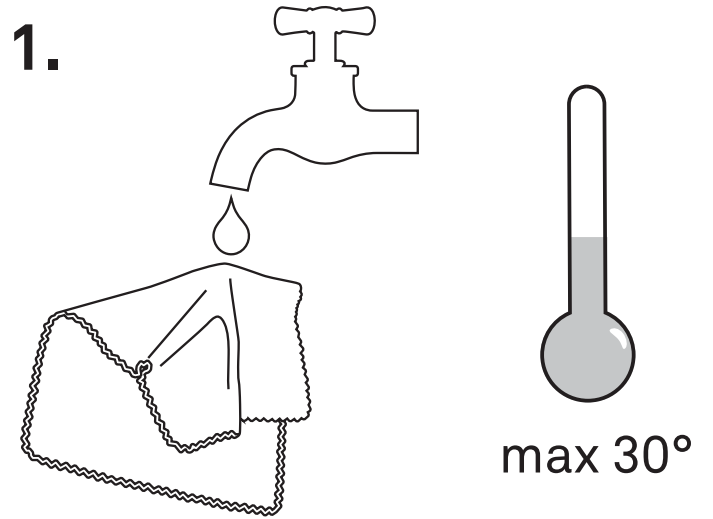
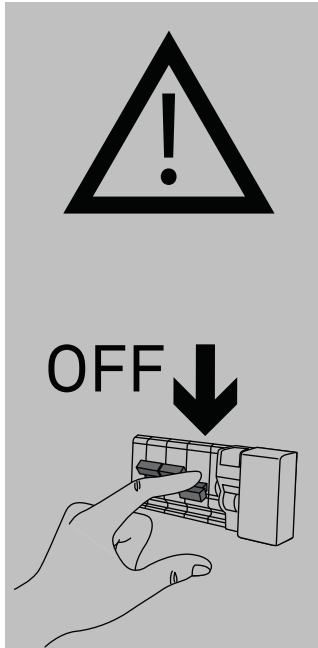



www.luceplan.com

D910IA001