



ELECTRICITY
1G, 2G, 3G & 4G
PREMIUM LED PUSH DIMMER

UK-DI-CO-1G-LED-A
UK-DI-CO-2G-LED-A
UK-DI-CO-3G-LED-A
UK-DI-CO-4G-LED-A



BUSTERANDPUNCH.COM

DIMMER TECHNICAL SPEC.

DIMMER STYLE:

1G, 2G, 3G, 4G PREMIUM LED PUSH DIMMER.
RATED AT 230-240V 50HZ PER GANG

LED / CFL	HALOGEN / INCANDESCENT	
1,2,3,4 GANG	1 GANG	2,3,4 GANG
5-120w max	400w max	250w max.

IMPORTANT NOTES

Please read before installing.

- These products must be installed in accordance with the latest Building and IEE wiring regulations. If in any doubt, please contact a qualified electrician.
- This dimmer is **only suitable for incandescent, halogen, dimmable LED and dimmable LED-filament bulbs**, but is not suitable for non dimmable LED or any CFL bulbs.
- Dimmer comes set at Leading Edge as factory default. Please check with an electrician that your circuit is Leading Edge if not follow the instructions to change the mode of the dimmer.

BACK BOXES

We recommend you to use a UK back box to install your product. Please note that the minimum recommended depth for the mounting box is 35mm. Back boxes are available to purchase from us, please see recommended sizes below:

DIMMER PLATE	RECOMMENDED BACKBOX
1G - 2G	1G UK Back box - SKU# ELB921
3G - 4G	2G UK Back Box - SKU# ELB922

RECYCLING ELECTRICAL PRODUCTS

Buster and Punch encourages all of its customers to make note of this symbol and avoid putting any waste electrical goods in your domestic waste bin or container. Please ensure you take your waste electrical goods to a suitable facility for disposal.



MINIMUM BRIGHTNESS LEVEL SETTING

How to set the minimum brightness level:

Operate steps of Dimmer and Switch	Actions
1.	With the Lamp in an OFF state, at max. position, push ON and wait 5 seconds until lamp stabilises.
2.	Turn to min. position. Push OFF and push ON at min. brightness level.
3.	Turn to max. position. Push OFF and push ON again. The lamp will appear to flash once at half-brightness level. You have now entered Minimum Dim Set Mode.
4.	Set your desired min. brightness level. Push OFF and ON once. The lamp will appear at half-brightness level then return to normal brightness level. It has now configured and saved your settings.

Each step must be performed within 10 seconds, if not, it will time out and auto exit the programme without saving. If you wish to terminate the setting mode, push OFF whilst the lamp is flashing.

MODE SETTING

How to set Trailing Edge (TE) or Leading Edge (LE) Mode. (Factory default is TE mode):
To set LE mode follow steps 1-4. To revert back to TE mode, follow steps 1-3 and 5.

Operate steps of Dimmer and Switch	Actions
1.	Set the lamp to min. position whilst in OFF state. Wait for around 5 seconds to push ON, until the lamp appears stable.
2.	Turn to max. position. Push OFF and push ON.
3.	Turn to min. position, push OFF and push ON again. Lamp will appear to flash 4 times at half-bright level. You can now either follow step 4 to enter TE mode or step 5 to enter LE mode.
To Select LE mode (for special required)	
4 (LE mode)	Turn to max. position, push OFF and push ON at max brightness level to confirm and save setting with flash 3 times.
To select TE mode (Factory default)	
5 (TE mode)	At min. position, push OFF and push ON at min. brightness level to confirm and save your desired setting. The lamp will flash once.

Each step must be performed within 10 seconds, if not, it will time out and auto exit program without saving.

INSTALLATION

- Before commencing work, isolate the mains power supply and remove the fuse in the fuse box or switch off the circuit breaker in the consumer unit.

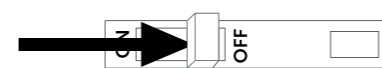

- If unit is to be used as a replacement for an existing product, remove existing unit from its location and disconnect the wiring.

CAUTION:
Verify power is OFF to switch before proceeding.

- Connect the wires as shown in appropriate wiring diagrams. Use green/yellow sleeving on earth conductors not insulated. Ensure terminals are properly tightened and no bare wire is visible. Push back unit into moulding box making sure conductors are not trapped.

If installing standard incandescent bulbs, check the total load of the module is between 60W and 400W max.
If installing LED bulbs, check the total load of the module is between 5W and 120W max.

DIMMER ON 1 WAY CIRCUIT

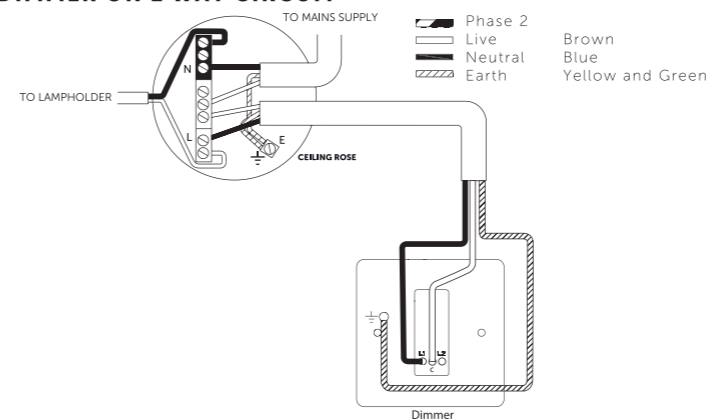

DIMMER ON 2 WAY CIRCUIT

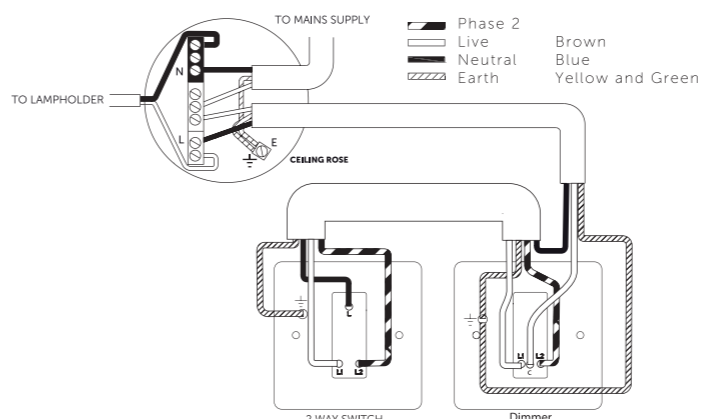

DIMMER ON 3 WAY CIRCUIT

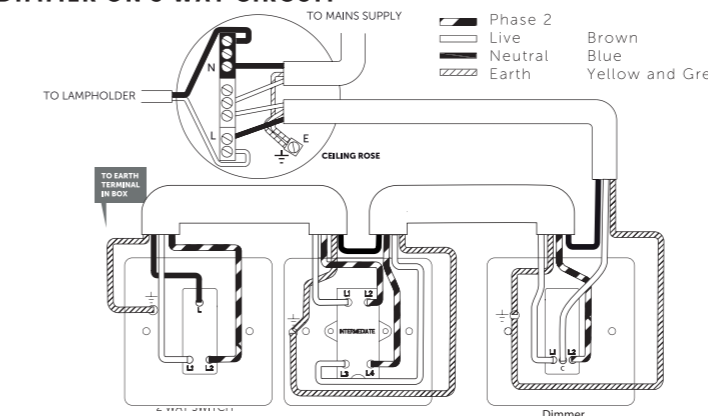

- Your product is supplied in 2 boxes, one box containing the switch plate and a further box containing the details kit. Open the details kit box and install the plate as follows.

- By hand, screw nut **A** in place (orientate as shown). Align **Flat C** to the corresponding flat on the inside of the Dimmer Knob **B**. Push the dimmer knob in place by hand.

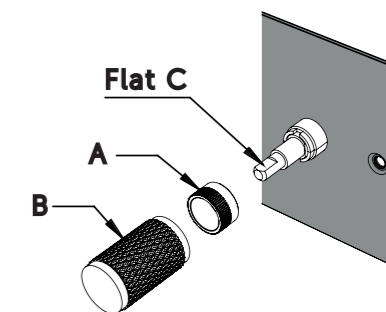

- Use a cross head electric or manual screwdriver to fit the special countersunk screws until tight*.

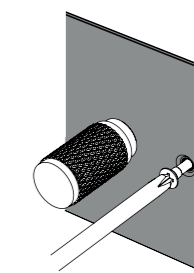

- By hand, screw the coin caps into the end of the screws. Use the plastic coin cap tool to fully tighten the coin caps**.

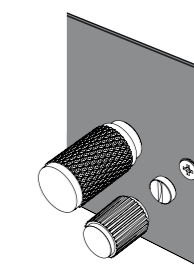

* Please ensure screws are sufficiently tight to support the product but please do not over tighten as this may cause some deformation to the plate or damage the screw.

** Do NOT use a standard screw driver to tighten the coin caps. This may damage the cap and is not covered under warranty. Plastic coin cap tool must be used by hand only.

- To reduce the risk of discolouration or tarnishing, avoid installation on wet plaster.

- Turn power back on.

