

# Volver, Breath of new *Light*

design Studio 14  
terzani.com

**TERZANI**  
LA LUCE PENSATA



**Type |**  
Suspension

**Materials |**  
Brass chains and metal  
structure plated as below

**Finishes | Code**

-  Nickel  
OL63S E7 C8
-  Black Nickel  
OL63S E9 C8
-  Bronze  
OL63S F7 C8
-  Gold  
OL63S L6 C8

**Body |**

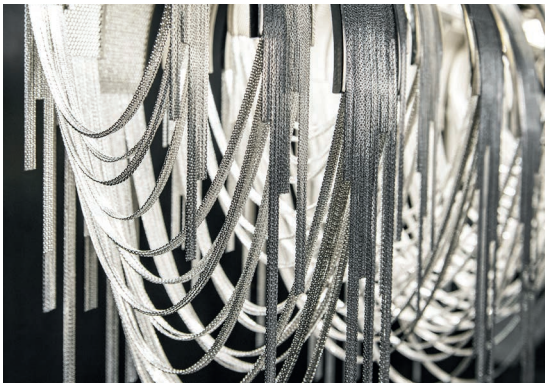
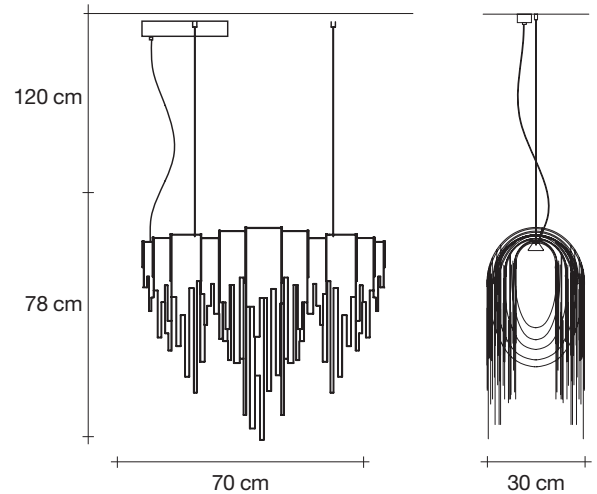

**Integrated Led |**  
100-240V ~ 50/60Hz

 LED integrated  
7 x 4,5W 3710 lm 3000K  
or optional 2700K

 Dimmable with 1-10V,  
PWM, 10-100 Ω  
Dali system on request

**Canopy |**

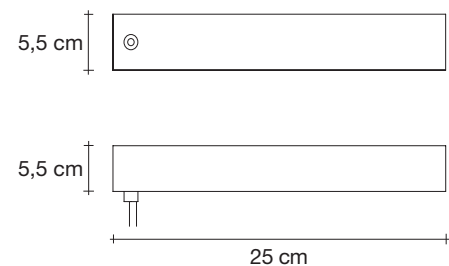

Designer Diego Bassetti and Architect Andrea Panzieri of Studio 14, protégés of Bruno Rainaldi, applied their multidisciplinary approach to create Terzani's first LED suspension light. This geometric design combines thin nickel chains with the latest in LED technology to create a light that is both elegant and modern. A breath of new light, Volver melds technology and art to achieve a new level of luxury.

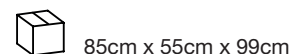

# Volver, Breath of new *Light*

design Studio 14  
terzani.com

**TERZANI**  
LA LUCE PENSATA







## Type |

Suspension

## Materials |

Brass chains and metal structure plated as below

## Finishes | Code

-  Nickel  
OL60S E7 C8
-  Black Nickel  
OL60S E9 C8
-  Bronze  
OL60S F7 C8
-  Gold  
OL60S L6 C8

## Body |

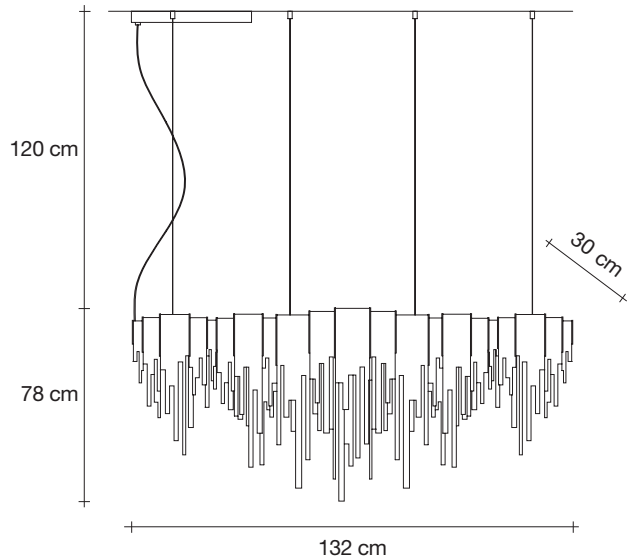

## Canopy |

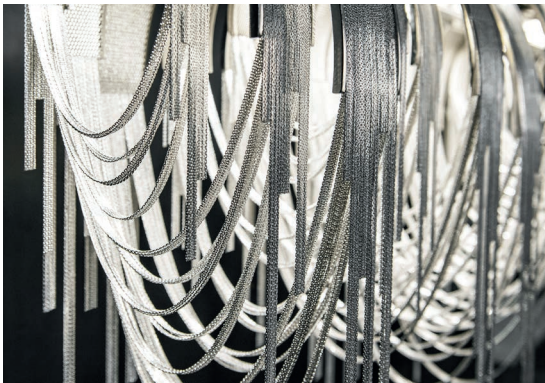
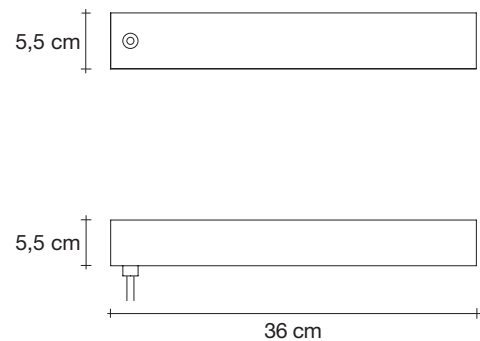

## Integrated Led |

230-240V ~ 50/60Hz



-  Dimmable with 1-10V,  
PWM, 10-100 Ω  
Dali system on request

Designer Diego Bassetti and Architect Andrea Panzieri of Studio 14, protégés of Bruno Rainaldi, applied their multidisciplinary approach to create Terzani's first LED suspension light. This geometric design combines thin nickel chains with the latest in LED technology to create a light that is both elegant and modern. A breath of new light, Volver melds technology and art to achieve a new level of luxury.



72



36,5



148cm x 55cm x 99cm

# Volver, Breath of new *Light*





design Studio 14  
terzani.com



**Type |**  
Suspension

**Materials |**  
Brass chains and metal structure plated as below

**Finishes | Code**

-  Nickel  
OL62S E7 C8
-  Black Nickel  
OL62S E9 C8
-  Bronze  
OL62S F7 C8
-  Gold  
OL62S L6 C8

**Body |**

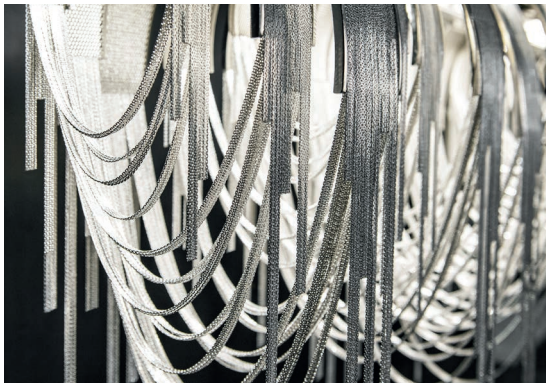
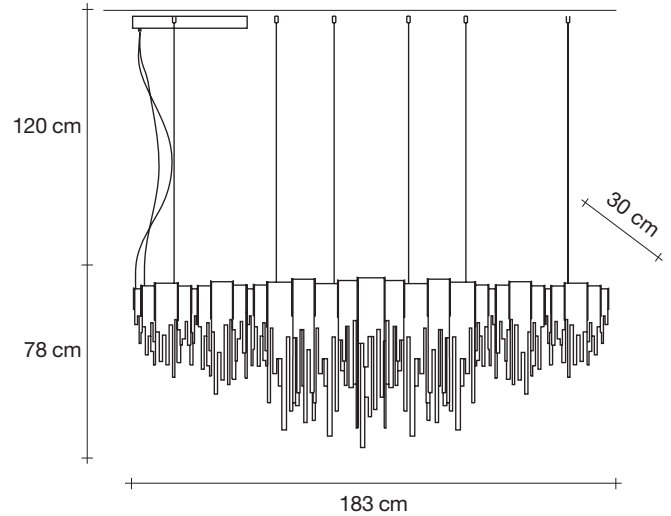

**Integrated Led |**  
230-240V ~ 50/60Hz

 LED integrated  
20 x 4,5W 10600 lm 3000K  
or optional 2700K

 Dimmable with 1-10V  
Dali system on request

**Canopy |**

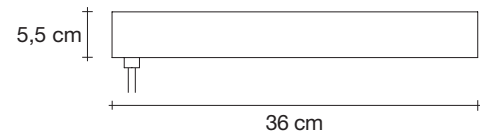

Designer Diego Bassetti and Architect Andrea Panzieri of Studio 14, protégés of Bruno Rainaldi, applied their multidisciplinary approach to create Terzani's first LED suspension light. This geometric design combines thin nickel chains with the latest in LED technology to create a light that is both elegant and modern. A breath of new light, Volver melds technology and art to achieve a new level of luxury.



95



45



199cm x 55cm x 99cm



# Volver, Breath of new *Light*

design Studio 14  
terzani.com

**TERZANI**  
LA LUCE PENSATA



**Type |**  
Suspension

**Materials |**  
Brass chains and metal  
structure plated as below

**Finishes | Code**

-  Nickel  
OL61S E7 C8
-  Black Nickel  
OL61S E9 C8
-  Bronze  
OL61S F7 C8
-  Gold  
OL61S L6 C8

**Body |**

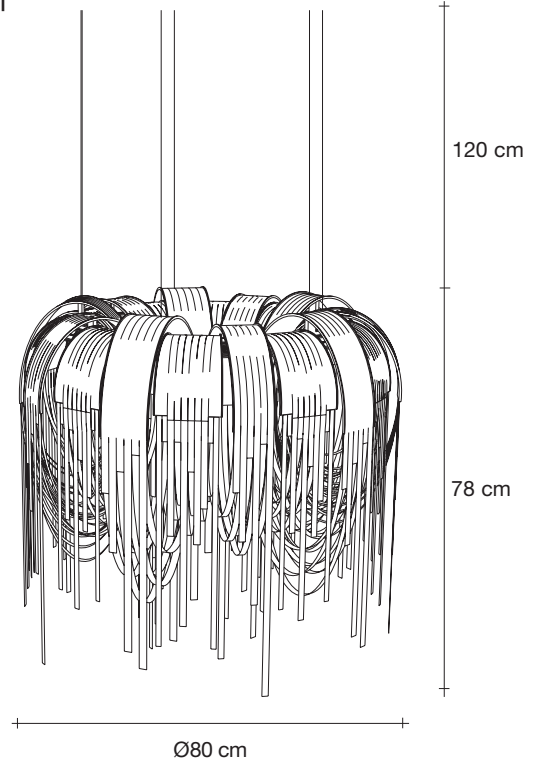

**Canopy |**

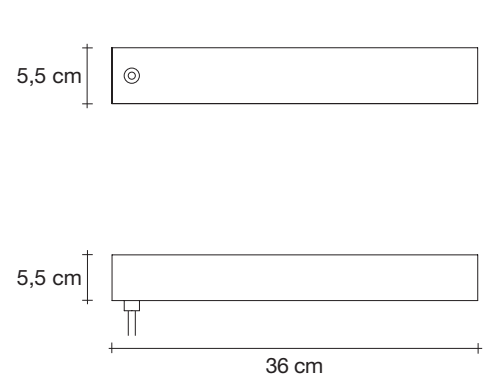

**Integrated Led |**  
230-240V ~ 50/60Hz

 LED integrated  
10 x 4,5W 5300 lm 3000K  
or optional 2700K

 Dimmable with 1-10V  
Dali system on request

Designer Diego Bassetti and Architect Andrea Panzieri of Studio 14, protégés of Bruno Rainaldi, applied their multidisciplinary approach to create Terzani's first LED suspension light. This geometric design combines thin nickel chains with the latest in LED technology to create a light that is both elegant and modern. A breath of new light, Volver melds technology and art to achieve a new level of luxury.



90



40



115cm x 115cm x 124cm