

Scale: 1:1

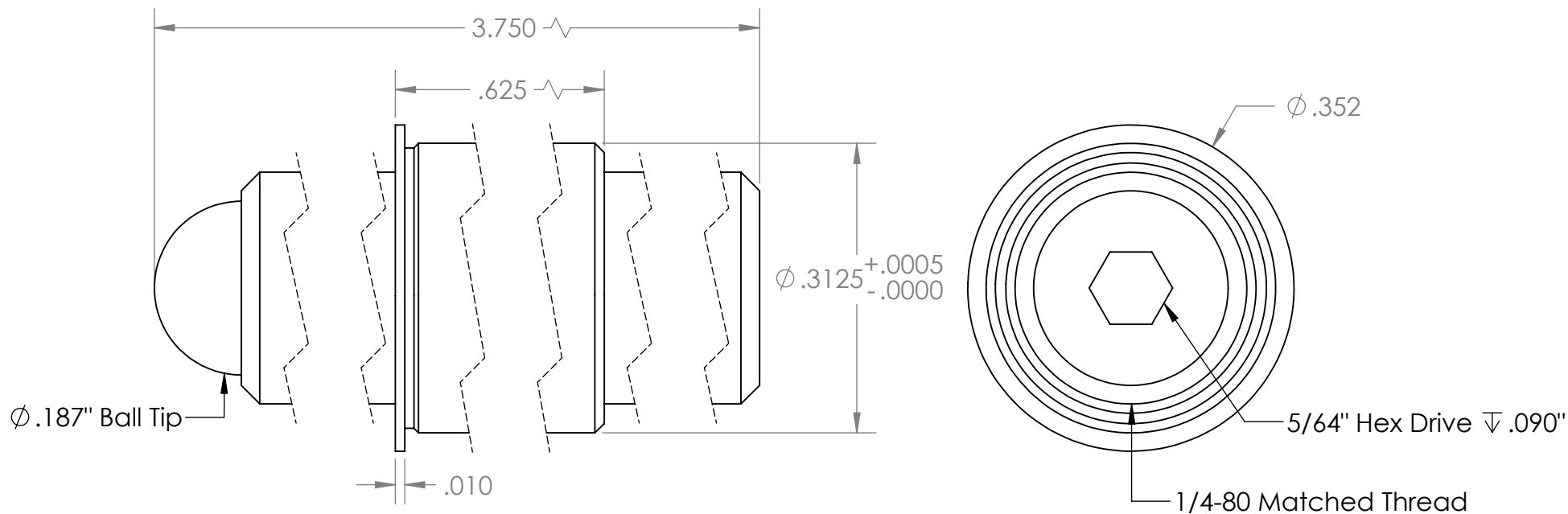

PROPRIETARY AND CONFIDENTIAL
 THE INFORMATION CONTAINED IN THIS DRAWING IS THE SOLE PROPERTY OF KOZAK MICRO ADJUSTERS. ANY REPRODUCTION IN PART OR AS A WHOLE WITHOUT THE WRITTEN PERMISSION OF KOZAK MICRO ADJUSTERS IS PROHIBITED.

		UNLESS OTHERWISE SPECIFIED:		NAME	DATE
		DIMENSIONS ARE IN INCHES	DRAWN	D.K.	10.09.12
		TOLERANCES:	CHECKED	D.K.	10.24.12
		FRACTIONAL ±1/64	ENG APPR.	D.K.	10.26.12
		ANGULAR: MACH ± BEND ±	MFG APPR.	G.K.	11.12.12
		TWO PLACE DECIMAL ±.01	Q.A.		
		THREE PLACE DECIMAL ±.005	COMMENTS:		
		INTERPRET GEOMETRIC TOLERANCING PER:			
		MATERIAL			
		303 SS & 360 Brass			
NEXT ASSY	USED ON	FINISH			
APPLICATION		DO NOT SCALE DRAWING			

Kozak Micro Adjusters		
TITLE:		
1/4-80 x 3.750" Adj. Screw & 0.625" Adj. Bushing		
SIZE	DWG. NO.	REV
A	TSB250-80-3750/625-AA	A
SCALE: 6:1	WEIGHT:	SHEET 1 OF 1