

Scale: 1:1

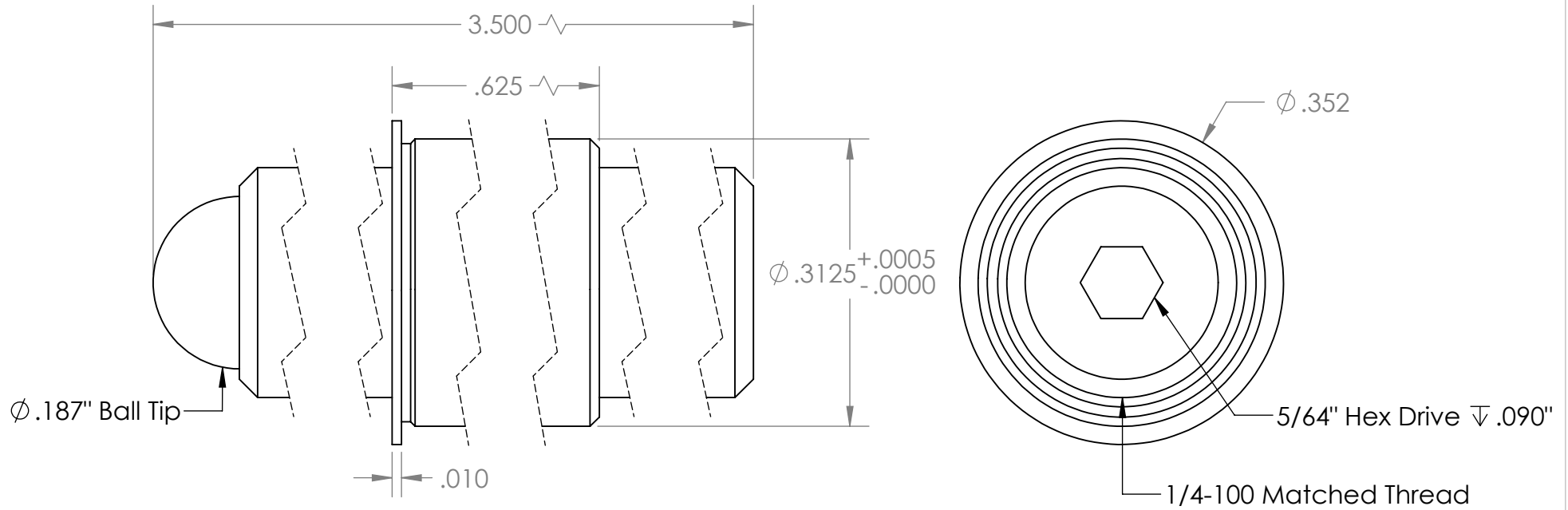

**PROPRIETARY AND CONFIDENTIAL**  
 THE INFORMATION CONTAINED IN THIS DRAWING IS THE SOLE PROPERTY OF KOZAK MICRO ADJUSTERS. ANY REPRODUCTION IN PART OR AS A WHOLE WITHOUT THE WRITTEN PERMISSION OF KOZAK MICRO ADJUSTERS IS PROHIBITED.

		UNLESS OTHERWISE SPECIFIED:		NAME	DATE	Kozak Micro Adjusters			
		DIMENSIONS ARE IN INCHES TOLERANCES: FRACTIONAL $\pm 1/64$ ANGULAR: MACH $\pm$ BEND $\pm$ TWO PLACE DECIMAL $\pm .01$ THREE PLACE DECIMAL $\pm .005$		DRAWN	D.K.			10.09.12	
		INTERPRET GEOMETRIC TOLERANCING PER:		CHECKED	D.K.	10.24.12	TITLE: 1/4-100 x 3.500" Adj. Screw & 0.625" Adj. Bushing		
		MATERIAL 303 SS & 360 Brass		ENG APPR.	D.K.	10.26.12			
		FINISH		MFG APPR.	G.K.	11.12.12			
NEXT ASSY	USED ON			Q.A.			SIZE	DWG. NO.	REV
APPLICATION		DO NOT SCALE DRAWING		COMMENTS:			<b>A</b>	TSB250-100-3500/625-AA	<b>A</b>
							SCALE: 6:1	WEIGHT:	SHEET 1 OF 1

5

4

3

2

1