

Scale: 4:1

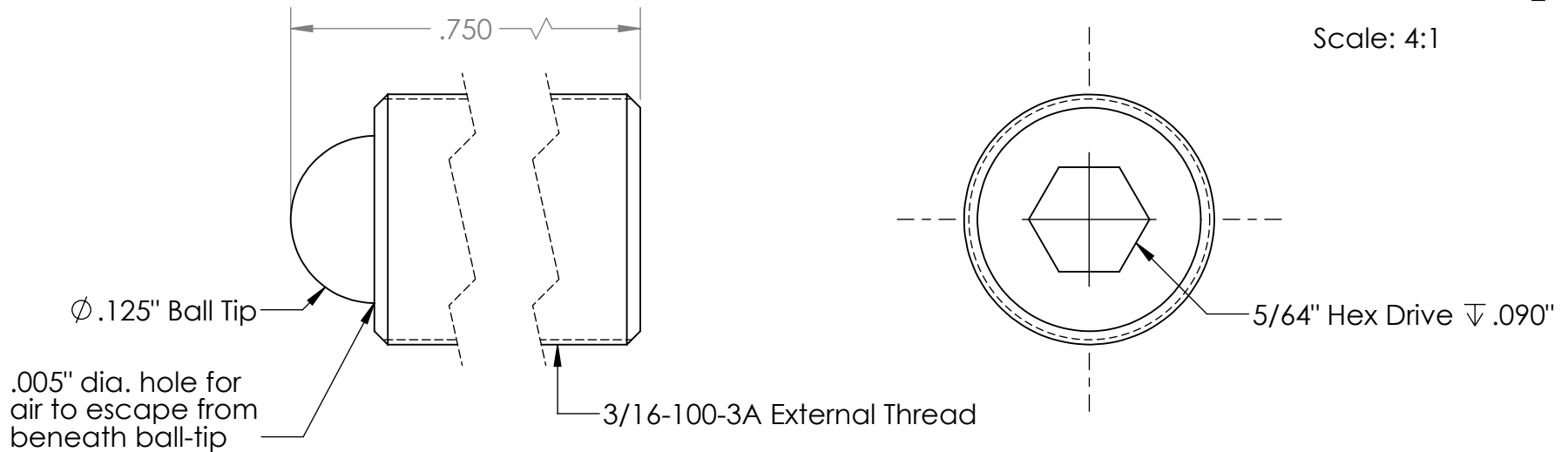

PROPRIETARY AND CONFIDENTIAL
 THE INFORMATION CONTAINED IN THIS DRAWING IS THE SOLE PROPERTY OF KOZAK MICRO ADJUSTERS. ANY REPRODUCTION IN PART OR AS A WHOLE WITHOUT THE WRITTEN PERMISSION OF KOZAK MICRO ADJUSTERS IS PROHIBITED.

		UNLESS OTHERWISE SPECIFIED:		NAME	DATE	Kozak Micro Adjusters		
		DIMENSIONS ARE IN INCHES TOLERANCES: FRACTIONAL $\pm 1/64$ ANGULAR: MACH \pm BEND \pm TWO PLACE DECIMAL $\pm .01$ THREE PLACE DECIMAL $\pm .005$	DRAWN	D.K.	10.09.12			TITLE: 3/16-100 x 0.750" Adj. Screw
		INTERPRET GEOMETRIC TOLERANCING PER:	CHECKED	D.K.	10.24.12	SIZE DWG. NO. REV A TS187-100-750-HV A		
		MATERIAL 304 Stainless Steel	ENG APPR.	D.K.	10.26.12			SCALE: 8:1 WEIGHT: SHEET 1 OF 1
NEXT ASSY	USED ON	FINISH	MFG APPR.	G.K.	11.12.12			
APPLICATION		DO NOT SCALE DRAWING	Q.A.					
			COMMENTS:					