

Scale: 2:1

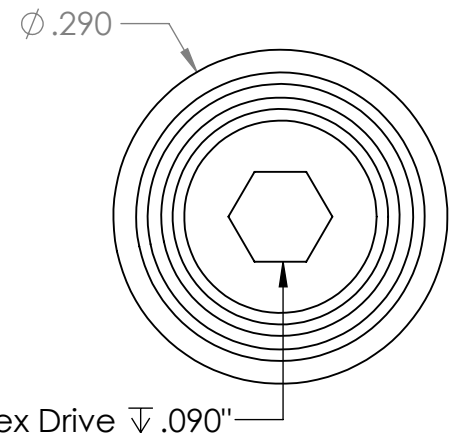
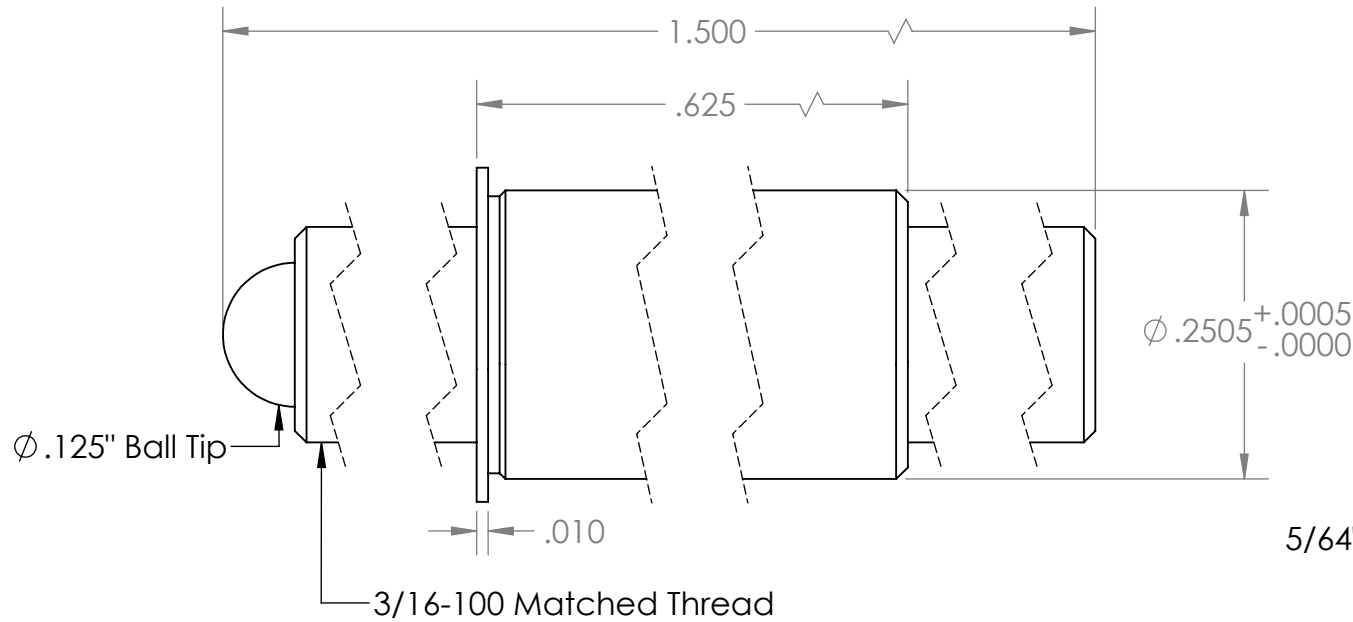

PROPRIETARY AND CONFIDENTIAL
 THE INFORMATION CONTAINED IN THIS DRAWING IS THE SOLE PROPERTY OF KOZAK MICRO ADJUSTERS. ANY REPRODUCTION IN PART OR AS A WHOLE WITHOUT THE WRITTEN PERMISSION OF KOZAK MICRO ADJUSTERS IS PROHIBITED.

		UNLESS OTHERWISE SPECIFIED:	NAME	DATE
		DIMENSIONS ARE IN INCHES	DRAWN	D.K. 10.09.12
		TOLERANCES:	CHECKED	D.K. 10.24.12
		FRACTIONAL $\pm 1/64$	ENG APPR.	D.K. 10.26.12
		ANGULAR: MACH \pm BEND \pm	MFG APPR.	G.K. 11.12.12
		TWO PLACE DECIMAL $\pm .01$	Q.A.	
		THREE PLACE DECIMAL $\pm .005$	COMMENTS:	
		INTERPRET GEOMETRIC TOLERANCING PER:		
		MATERIAL		
		303 SS & 360 Brass		
NEXT ASSY	USED ON	FINISH		
APPLICATION		DO NOT SCALE DRAWING		

Kozak Micro Adjusters		
TITLE:		
3/16-100 x 1.500" Adj. Screw & 0.625" Adj. Bushing		
SIZE	DWG. NO.	REV
A	TSB187-100-1500/625	A
SCALE: 6:1	WEIGHT:	SHEET 1 OF 1