

Scale: 2:1

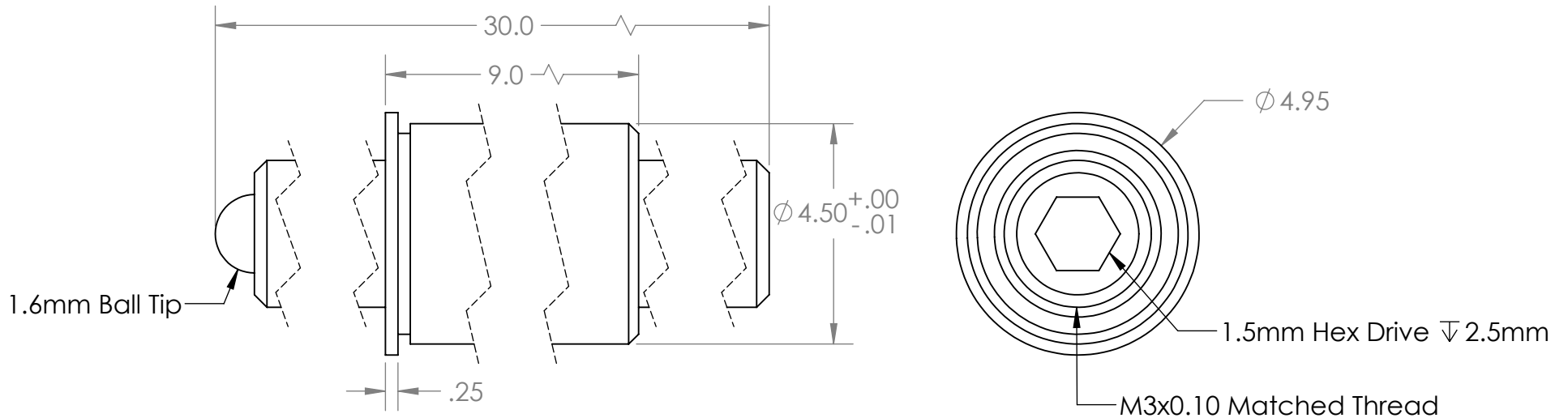

PROPRIETARY AND CONFIDENTIAL
 THE INFORMATION CONTAINED IN THIS DRAWING IS THE SOLE PROPERTY OF KOZAK MICRO ADJUSTERS. ANY REPRODUCTION IN PART OR AS A WHOLE WITHOUT THE WRITTEN PERMISSION OF KOZAK MICRO ADJUSTERS IS PROHIBITED.

		UNLESS OTHERWISE SPECIFIED:		NAME	DATE	Kozak Micro Adjusters	
		DIMENSIONS ARE IN MILLIMETERS	DRAWN	D.K.	10.09.12		
		TOLERANCES:	CHECKED	D.K.	10.24.12		
		FRACTIONAL ±	ENG APPR.	D.K.	10.26.12		
		ANGULAR: MACH ± BEND ±	MFG APPR.	G.K.	11.12.12		
		ONE PLACE DECIMAL ±.1	Q.A.			SIZE DWG. NO. REV	
		TWO PLACE DECIMAL ±.01	COMMENTS:			A TSBM3-10-30/9 A	
		INTERPRET GEOMETRIC TOLERANCING PER:				SCALE: 8:1 WEIGHT: SHEET 1 OF 1	
		MATERIAL					
		303 SS & 360 Brass					
NEXT ASSY		USED ON					
APPLICATION		DO NOT SCALE DRAWING					

5

4

3

2

1