

Scale: 4:1

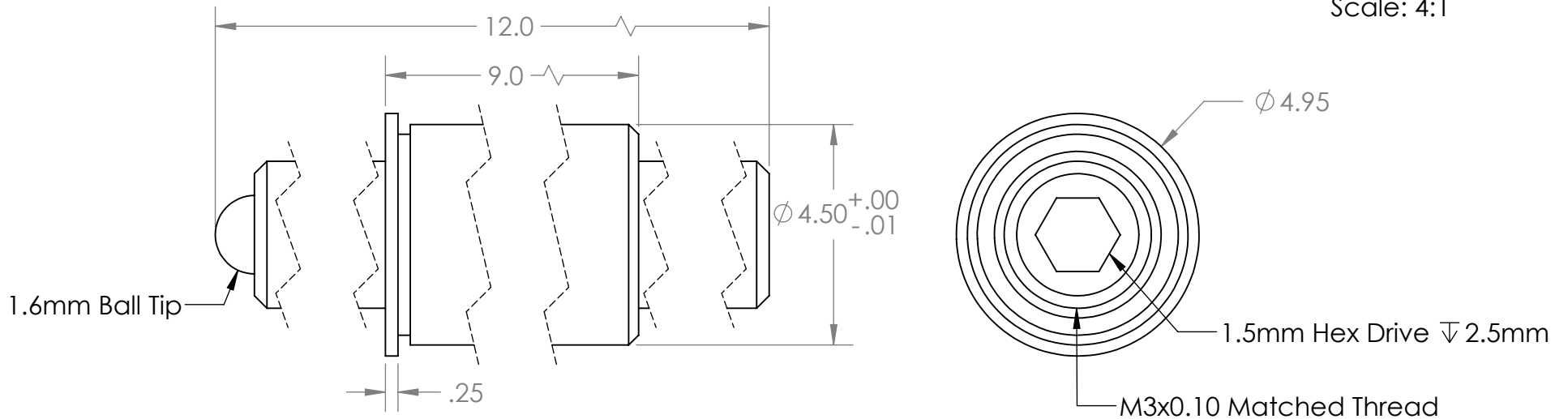

PROPRIETARY AND CONFIDENTIAL
 THE INFORMATION CONTAINED IN THIS DRAWING IS THE SOLE PROPERTY OF KOZAK MICRO ADJUSTERS. ANY REPRODUCTION IN PART OR AS A WHOLE WITHOUT THE WRITTEN PERMISSION OF KOZAK MICRO ADJUSTERS IS PROHIBITED.

		UNLESS OTHERWISE SPECIFIED:		NAME	DATE	Kozak Micro Adjusters		
		DIMENSIONS ARE IN MILLIMETERS	DRAWN	D.K.	10.09.12			TITLE: M3-0.10 x 12.0mm Adj. Screw & 9.0mm Adj. Bushing
		TOLERANCES:	CHECKED	D.K.	10.24.12			
		FRACTIONAL ±	ENG APPR.	D.K.	10.26.12			
		ANGULAR: MACH ± BEND ±	MFG APPR.	G.K.	11.12.12			
		ONE PLACE DECIMAL ±.1	Q.A.			SIZE DWG. NO. REV		
		TWO PLACE DECIMAL ±.01	COMMENTS:			A	TSBM3-10-12/9	A
		INTERPRET GEOMETRIC TOLERANCING PER:				SCALE: 8:1 WEIGHT:		SHEET 1 OF 1
		MATERIAL						
		303 SS & 360 Brass						
NEXT ASSY		USED ON						
APPLICATION		DO NOT SCALE DRAWING						

5

4

3

2

1