

Scale: 2:1

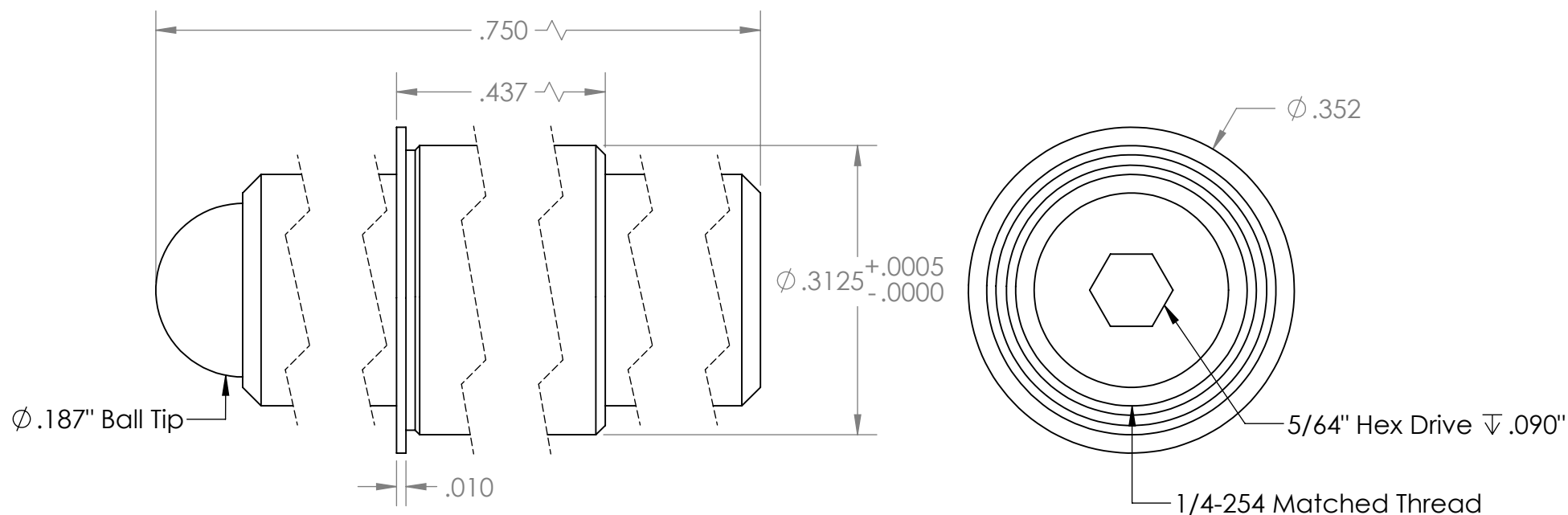

PROPRIETARY AND CONFIDENTIAL
 THE INFORMATION CONTAINED IN THIS DRAWING IS THE SOLE PROPERTY OF KOZAK MICRO ADJUSTERS. ANY REPRODUCTION IN PART OR AS A WHOLE WITHOUT THE WRITTEN PERMISSION OF KOZAK MICRO ADJUSTERS IS PROHIBITED.

		UNLESS OTHERWISE SPECIFIED:		NAME	DATE	Kozak Micro Adjusters			
		DIMENSIONS ARE IN INCHES TOLERANCES: FRACTIONAL ±1/64 ANGULAR: MACH ± BEND ± TWO PLACE DECIMAL ±.01 THREE PLACE DECIMAL ±.005		DRAWN	D.K.			10.09.12	
		INTERPRET GEOMETRIC TOLERANCING PER:		CHECKED	D.K.	10.24.12	TITLE: 1/4-254 x 0.750" Adj. Screw & 0.437" Adj. Bushing		
		MATERIAL 303 SS & 360 Brass		ENG APPR.	D.K.	10.26.12			
		FINISH		MFG APPR.	G.K.	11.12.12			
NEXT ASSY	USED ON			Q.A.			SIZE	DWG. NO.	REV
APPLICATION		DO NOT SCALE DRAWING		COMMENTS:			A	TSB250-254-750/437-AA	A
							SCALE: 6:1	WEIGHT:	SHEET 1 OF 1

5

4

3

2

1