

Scale: 3:2

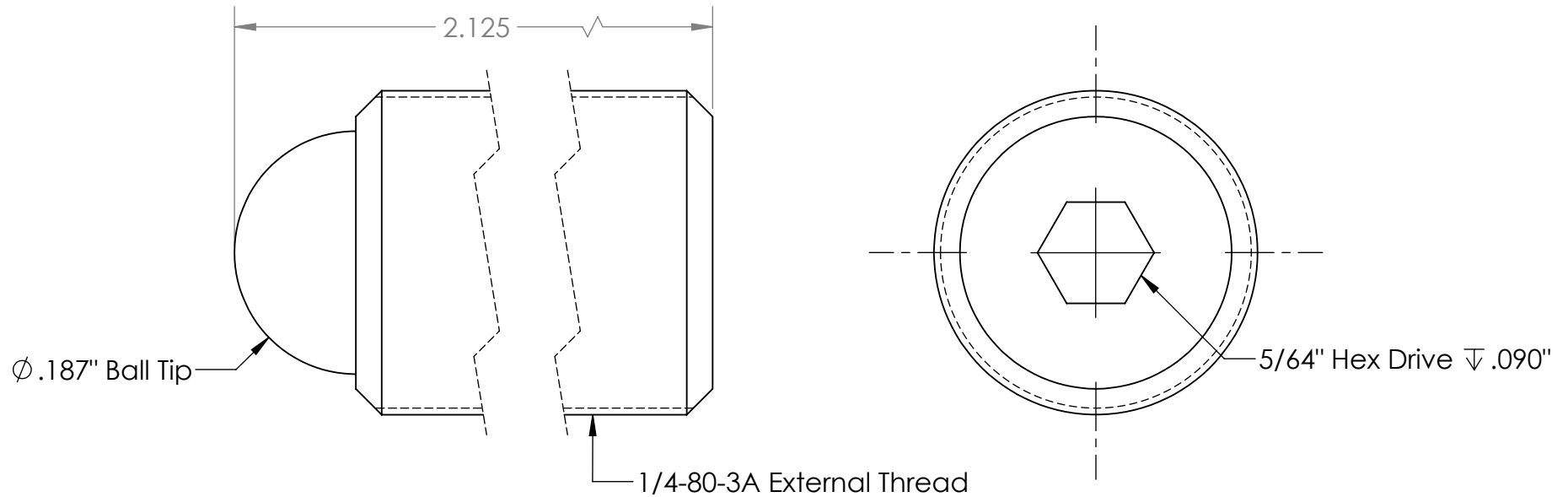

**PROPRIETARY AND CONFIDENTIAL**  
 THE INFORMATION CONTAINED IN THIS DRAWING IS THE SOLE PROPERTY OF KOZAK MICRO ADJUSTERS. ANY REPRODUCTION IN PART OR AS A WHOLE WITHOUT THE WRITTEN PERMISSION OF KOZAK MICRO ADJUSTERS IS PROHIBITED.

		UNLESS OTHERWISE SPECIFIED:		NAME	DATE
		DIMENSIONS ARE IN INCHES	DRAWN	D.K.	10.09.12
		TOLERANCES:	CHECKED	D.K.	10.24.12
		FRACTIONAL ±1/64	ENG APPR.	D.K.	10.26.12
		ANGULAR: MACH ± BEND ±	MFG APPR.	G.K.	11.12.12
		TWO PLACE DECIMAL ±.01			
		THREE PLACE DECIMAL ±.005			
		INTERPRET GEOMETRIC TOLERANCING PER:	Q.A.		
		MATERIAL	COMMENTS:		
		303 Stainless Steel			
NEXT ASSY	USED ON	FINISH			
APPLICATION		DO NOT SCALE DRAWING			

Kozak Micro Adjusters		
TITLE:		
1/4-80 x 2.125" Adj. Screw		
SIZE	DWG. NO.	REV
<b>A</b>	TS250-80-2125-AA	<b>A</b>
SCALE: 8:1	WEIGHT:	SHEET 1 OF 1