

Scale: 6:1

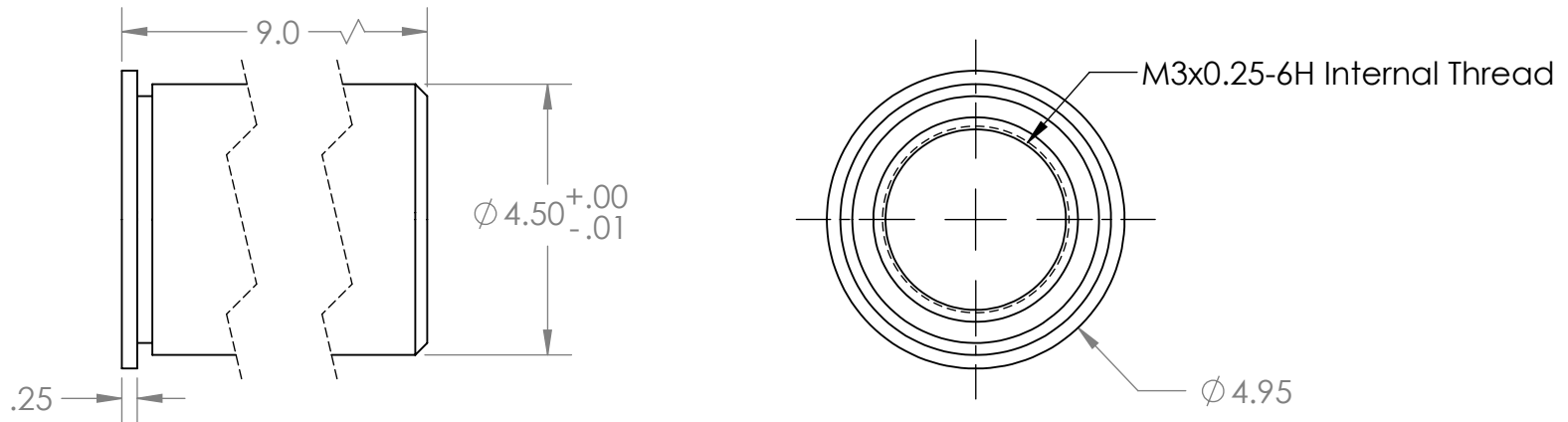

**PROPRIETARY AND CONFIDENTIAL**  
 THE INFORMATION CONTAINED IN THIS DRAWING IS THE SOLE PROPERTY OF KOZAK MICRO ADJUSTERS. ANY REPRODUCTION IN PART OR AS A WHOLE WITHOUT THE WRITTEN PERMISSION OF KOZAK MICRO ADJUSTERS IS PROHIBITED.

		UNLESS OTHERWISE SPECIFIED:		NAME	DATE	Kozak Micro Adjusters	
		DIMENSIONS ARE IN MILLIMETERS	DRAWN	D.K.	10.09.12		
		TOLERANCES:	CHECKED	D.K.	10.24.12	SIZE DWG. NO. REV <b>A</b> TB3-25-09 <b>A</b>	
		FRACTIONAL ±	ENG APPR.	D.K.	10.26.12		
		ANGULAR: MACH ± BEND ±	MFG APPR.	G.K.	11.12.12		
		ONE PLACE DECIMAL ±.1	Q.A.				
		TWO PLACE DECIMAL ±.01	COMMENTS:				
		INTERPRET GEOMETRIC TOLERANCING PER:					
		MATERIAL					
		360 Brass					
		FINISH					
NEXT ASSY	USED ON						
APPLICATION		DO NOT SCALE DRAWING					

5

4

3

2

1