

Scale: 4:1

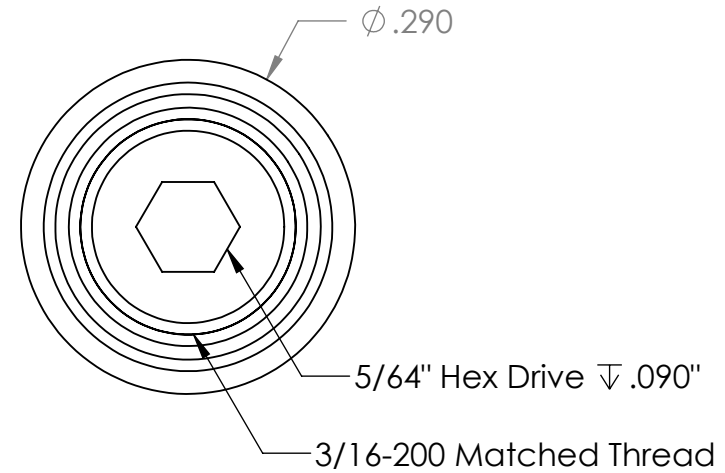
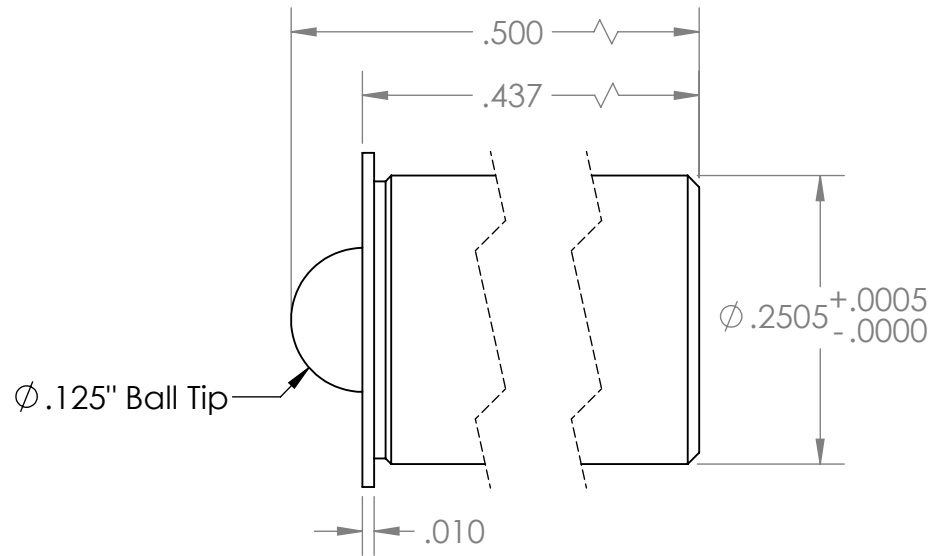

**PROPRIETARY AND CONFIDENTIAL**  
 THE INFORMATION CONTAINED IN THIS DRAWING IS THE SOLE PROPERTY OF KOZAK MICRO ADJUSTERS. ANY REPRODUCTION IN PART OR AS A WHOLE WITHOUT THE WRITTEN PERMISSION OF KOZAK MICRO ADJUSTERS IS PROHIBITED.

		UNLESS OTHERWISE SPECIFIED:		NAME	DATE	Kozak Micro Adjusters		
		DIMENSIONS ARE IN INCHES TOLERANCES: FRACTIONAL $\pm 1/64$ ANGULAR: MACH $\pm$ BEND $\pm$ TWO PLACE DECIMAL $\pm .01$ THREE PLACE DECIMAL $\pm .005$	DRAWN	D.K.	10.09.12			TITLE: 3/16-200 x 0.500" Adj. Screw & 0.437" Adj. Bushing
		INTERPRET GEOMETRIC TOLERANCING PER:	CHECKED	D.K.	10.24.12	SIZE DWG. NO. REV <b>A</b> TSB187-200-500/437 <b>A</b>		
		MATERIAL 303 SS & 360 Brass	ENG APPR.	D.K.	10.26.12			SCALE: 6:1 WEIGHT: SHEET 1 OF 1
NEXT ASSY	USED ON	FINISH	MFG APPR.	G.K.	11.12.12			
APPLICATION		DO NOT SCALE DRAWING	Q.A.					
			COMMENTS:					