

Scale: 2:1

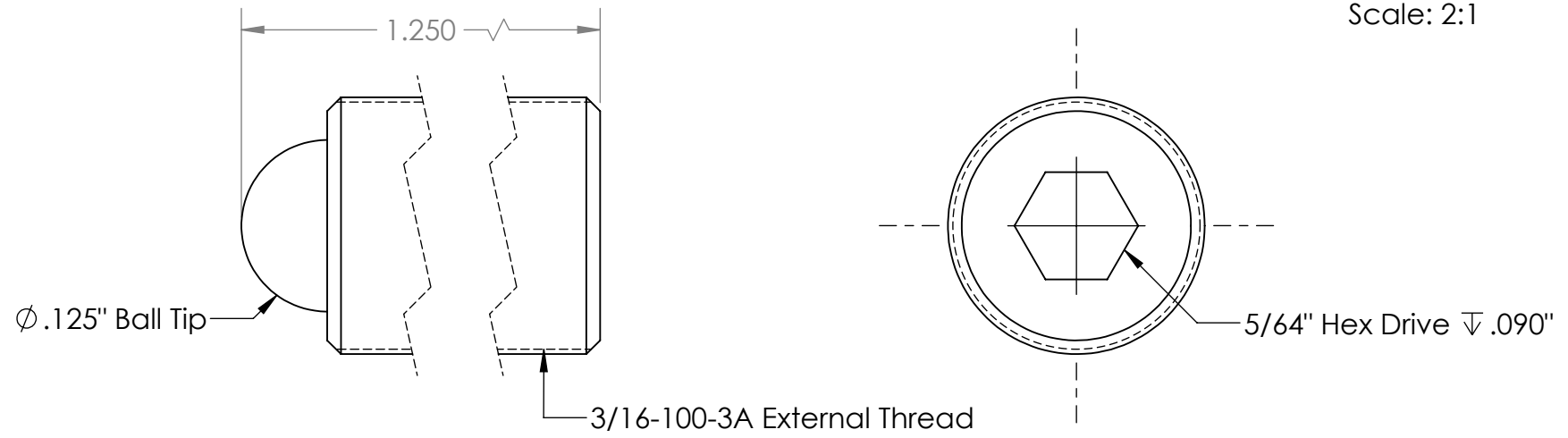

**PROPRIETARY AND CONFIDENTIAL**  
 THE INFORMATION CONTAINED IN THIS DRAWING IS THE SOLE PROPERTY OF KOZAK MICRO ADJUSTERS. ANY REPRODUCTION IN PART OR AS A WHOLE WITHOUT THE WRITTEN PERMISSION OF KOZAK MICRO ADJUSTERS IS PROHIBITED.

		UNLESS OTHERWISE SPECIFIED:		NAME	DATE
		DIMENSIONS ARE IN INCHES	DRAWN	D.K.	10.09.12
		TOLERANCES:	CHECKED	D.K.	10.24.12
		FRACTIONAL $\pm 1/64$	ENG APPR.	D.K.	10.26.12
		ANGULAR: MACH $\pm$ BEND $\pm$	MFG APPR.	G.K.	11.12.12
		TWO PLACE DECIMAL $\pm .01$	Q.A.		
		THREE PLACE DECIMAL $\pm .005$	COMMENTS:		
		INTERPRET GEOMETRIC TOLERANCING PER:			
		MATERIAL			
		303 Stainless Steel			
NEXT ASSY	USED ON	FINISH			
APPLICATION		DO NOT SCALE DRAWING			

Kozak Micro Adjusters		
TITLE:		
3/16-100 x 1.250" Adj. Screw		
SIZE	DWG. NO.	REV
<b>A</b>	TS187-100-1250	<b>A</b>
SCALE: 8:1	WEIGHT:	SHEET 1 OF 1