



Poolican®

THE 4-IN-1 SOLUTION FOR POOLS

CIRCULATION

FILTRATION

HEAT PUMP

WATER TREATMENT

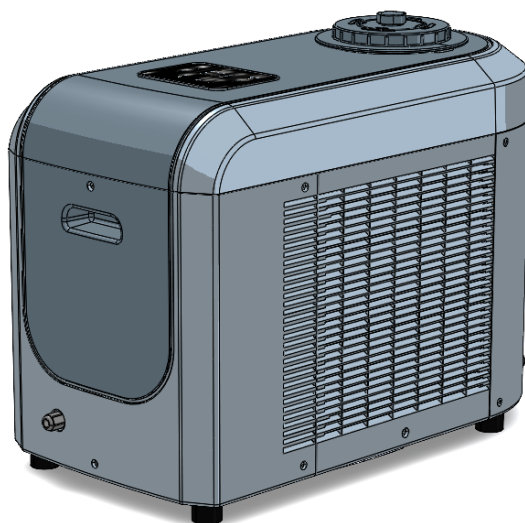

INSTALLATION AND OPERATION MANUAL

Please read carefully and retain for future reference

!WARNINGS!



This heat pump contains R32 flammable refrigerant. Prior approval must be obtained before any procedure is performed on the refrigerant circuit.

To ensure user safety, the following precautions must be followed before any procedure is performed on the refrigerant circuit.

1. Work procedure

All work must be carried out in accordance with strict guidelines in order to minimise the risk of gas or flammable vapour escaping during the execution of the work.

2. General workplace conditions

All persons present in the work area must be informed as to the nature of the work being carried out. Avoid performing work in confined spaces. The area surrounding the workspace must be cordoned off and particular attention must be paid to nearby sources of heat or flames.

3. Monitoring the presence of refrigerant

The area must be monitored for the presence of refrigerant, using an appropriate detector, before and after any work takes place in order to ensure that no potentially flammable gas has escaped. Ensure the equipment used for detecting leaks is suitable for flammable refrigerants, i.e., does not generate sparks, the device is properly sealed or equipped with internal safety measures.

4. Fire extinguishers

If hot work is being performed on the refrigeration system, or any related system, appropriate fire extinguishing equipment must be available. Install a dry powder or CO₂ fire extinguisher near the work area.

5. No sources of heat, open flames or sparks

The presence of heat sources, open flames or sparks in close proximity to one or more parts/pipework containing or having contained flammable refrigerant is strictly prohibited. All sources of sparks, including smoking, must be located sufficiently far away from the site of installation, repairs, removal and disposal, during which flammable refrigerant could escape into the surrounding environment. Before beginning work, the environment surrounding the equipment must be verified to ensure there is no source of ignition. "No smoking" signs must be displayed.

6. Ventilated area

Ensure that the workplace is open to the air, or properly ventilated, before performing any work on the system or carrying out hot work. Sufficient ventilation must be maintained throughout the period of work.

7. Inspection of refrigeration equipment

When electrical components are replaced, they must be suitable for their intended use and meet the relevant specifications. Replacements must be genuine or OEM parts. If in doubt, contact the manufacturer's customer support team.

Inspections must be performed on installations using flammable refrigerants:

- Refrigerant charge must be appropriate for the size of the space in which the refrigeration system is installed.
- The ventilation system and air vents must function correctly and must not be obstructed.
- If an indirect refrigeration system is being used, the secondary circuit must also be inspected.
- Equipment markings must be clearly visible and legible. Illegible signs and markings must be corrected.
- Refrigerant pipework and components must be installed in locations with no risk of exposure to substances capable of corroding components containing refrigerant fluid.

8. Inspection of electrical appliances

Repairs and maintenance performed on electrical appliances must include preliminary safety tests and inspection of components. In the event a fault is detected which is capable of compromising safety, electrical power must be disconnected from the circuit until the problem is resolved.

9. Preliminary safety tests must include the following:

- Ensuring the condensers are fully discharged: this must be performed in a safe manner to avoid the risk of ignition.
- Ensuring that no wires or electrical components are exposed at the time of charging, recovery, or purging the system of refrigerant gas.
- Ground continuity test.

1. ACKNOWLEDGEMENTS

Dear customer,

Thank you for your purchase and your trust in our products.

Our products are the result of years of research in the design and manufacture of heat pumps, water treatment, and filtration systems for pools. Our goal is to deliver high-quality products with exceptional performance.

We took great care to put together this manual so you can get the most out of your POOLEX all-in-one system.

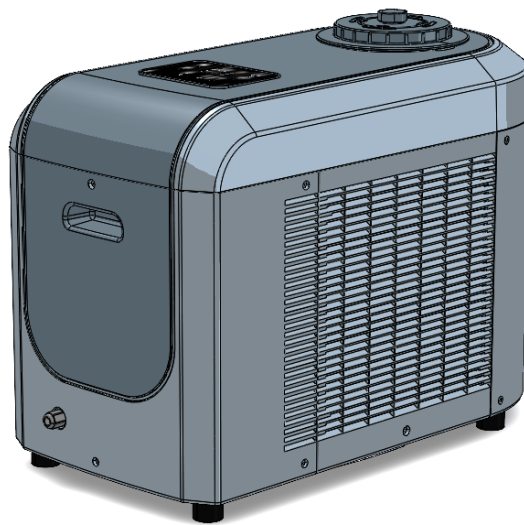

! PLEASE READ CAREFULLY !

**These installation instructions form an integral part of the product.
They must be provided to the installer and kept in a safe place by the user.
If you lose this manual, please visit our website:**

www.poolex.fr

The warnings and guidelines contained in this manual must be carefully read and understood; they provide important information concerning the safe handling and operation of your product. **Keep this manual handy for future reference.**

Installation must be performed by a qualified professional in accordance with regulations in force and the manufacturer's instructions. Errors made during installation can cause physical injuries to people and animals, as well as mechanical damage for which the manufacturer shall not be held liable.

After unpacking your POOLICAN, please check the contents for any signs of damage.

Before plugging in, ensure that the instructions provided in this manual are compatible with the actual installation conditions and do not exceed the maximum authorised limits for the product in question.

In the event of a defect and/or malfunction, electrical power must be shut off and no attempts to repair the fault should be made. Repairs must be carried out by an authorised technician using original spare parts. Non-compliance with the aforementioned clauses can negatively impact the safe operation of the POOLICAN.

In order to guarantee the efficiency and ensure the proper functioning of your product, it must be regularly maintained in accordance with the instructions provided.

In the event the POOLICAN is sold or transferred to a third party, please ensure that all technical documentation is given to the new owner alongside the equipment.

POOLICAN is designed exclusively for the treatment of swimming pools. Any other use is considered inappropriate, incorrect and potentially dangerous.

All contractual and extra-contractual liability on the part of the manufacturer / distributor shall be considered null and void in the event of damage caused by errors in installation or operation, or due to non-compliance with the instructions provided in this manual, or the standards in force for the installation of equipment discussed in this document.

2. SUMMARY











1.	ACKNOWLEDGEMENTS	2
2.	SUMMARY	5
3.	GENERAL TERMS AND CONDITIONS OF DELIVERY	6
4.	SAFETY INSTRUCTIONS	7
5.	HOW IT WORKS	8
6.	OPERATING LIMITS	9
	Heat pump	9
	Circulation / Filtration	9
	Salt chlorination	10
7.	FEATURES	11
	Dimensions	11
	Exploded view	12
8.	INSTALLATION	12
	Installation diagram	13
	Hydraulic connections	14
	Electrical connections	15
9.	BEFORE USE	16
	Adding salt	16
	Required salt levels	16
	Required stabiliser levels	17
10.	USING THE CONTROL PANEL	18
	Button functions and usage	18
	Easy to use in four simple steps	19
	Covered mode	20
	Setting the desired temperature	20
	Setting filtration time	21
	Adjusting parameters using the control panel	21
	Setting water treatment time (in hours)	22
11.	USING THE APP	23
	Overview of the application control panel	24
	Change operating parameters	24
	1 Filtration settings	26
	2 Water treatment settings	27
	3 Programming a schedule	27
	4 Verification of heat pump parameters (indicators only)	28
12.	MAINTENANCE, SERVICING AND WINTERIZING	29
	Cleaning	29
	Regular maintenance	29
	Draining	29
	Winterizing	30
13.	BREAKDOWN AND FAULTS	31
14.	WIRING DIAGRAM	32
15.	WARRANTY	34

3. GENERAL TERMS AND CONDITIONS OF DELIVERY

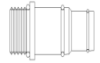
All products and packaging, even those delivered carriage paid, travel at the risk of the recipient. Persons responsible for accepting delivery of the device must perform a visual inspection to make a note any damage that may have occurred during transportation. Any damage occurring during transportation must be noted by the recipient on the delivery receipt of the carrier and confirmed by registered post sent to the carrier within 48 hours.

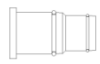

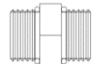
The device must be stored and transported upright at all times, on a pallet, and in its original packaging.

Name	Quantity	Shape	Schematic (Chapter 8)
Manual	1		
2-position valve	2		
Y strainer with internal mesh	1		
POOLICAN 1.5" to D32/38 connector	4		
38mm to 32mm reducer coupling	2		
Male 1.5" / male 1.5" connector	1		
6-in-1 water test strips	5	/	
Salinity test strips	2	/	
Φ21-44 stainless steel hose clamps	8		

4. SAFETY INSTRUCTIONS

When in use

Do not touch the vent during operation due to the risk of serious injury.

Do not leave the heat pump within reach of children due to the risk of injury caused by the heat exchanger fins.

Do not switch on the unit without water in the pool.

Check the flow rate of the water every month and regularly clean the filter.

In case of frequent use, consider using the boost function.

When cleaning

Switch off the power supply to the device.

Close the water inlet and outlet valves.

Do not place anything in the openings of the water or air inlets/outlets.

Do not spray the appliance with excessive amounts of water.

NON-COMPLIANCE WITH THESE WARNINGS CAN RESULT IN PROPERTY DAMAGE, ELECTRIC SHOCK, COMPLICATIONS, SERIOUS INJURIES, AND EVEN DEATH.



To avoid the risk of injury, do not allow children to operate this device.

Intensive use of the pool, or periods of high temperature, may require an increased level of chlorine production in order to maintain adequate levels of free chlorine.

5. HOW IT WORKS

POOLICAN is the all-in-one system designed for pools which fulfils all of the main functions required by your pool:

- CIRCULATION / FILTRATION
- HEATING
- WATER TREATMENT

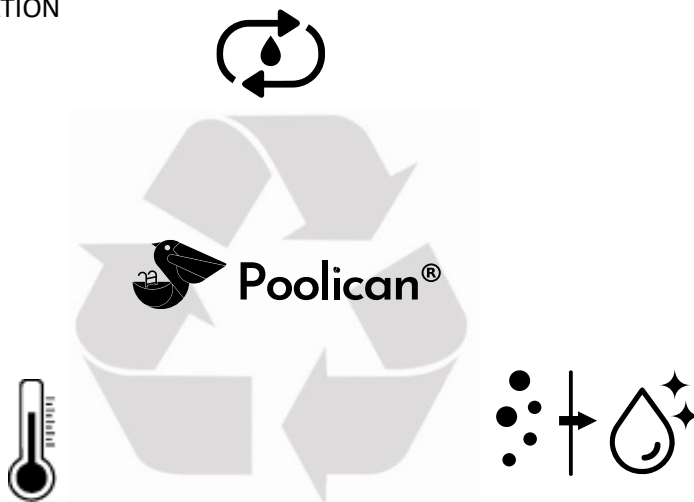

The first step is setting your desired temperature, and from there adjusting the settings of the other elements in order to reach this value according to the size of your pool.

The heat pump recovers energy from the surrounding air and transfers this energy to your pool yielding up to 5 times the power consumed. Despite its compact size, the POOLICAN can heat up to 25m³ depending on its geographic location. Please note: for better efficiency and in order to save energy, we strongly recommended covering your pool immediately after use.

Filtration is done using a cartridge filter with a large surface area in combination with a low flow rate (3.5m³/h) and low power (300W) circulation pump. This allows water to be filtered throughout the day and optimises water circulation in the heat pump for improved temperature regulation.

Thus, filtration time must be sufficiently long in order to achieve high-quality filtration (see paragraph titled "Setting filtration time" on page 21).

Salt chlorination of a pool works by using salt electrolysis to sanitise the water; this electrochemical process converts the salt present in the water into a disinfectant (hypochlorite ions).

Once this process is complete, these hypochlorite ions revert back to salt after coming into contact with organic material (bacteria, cells), or under the effect of UV rays or other sources of light, and the cycle begins over again.

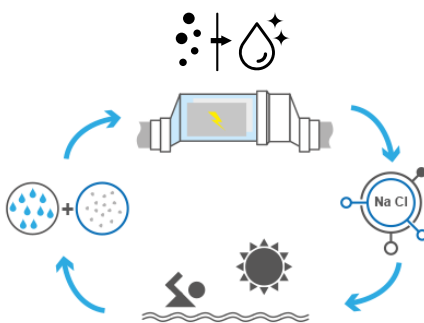

In order to maintain good levels of disinfectant in the water, the following factors must be respected:

- Appropriate concentration of salt in the water: **3g/l** (or 3kg/m³),
- Correct stabiliser level (between 20ppm and 50ppm),
- Sufficient filtration time,
- Good water balance with a **pH between 7.0 and 7.6**,
- Regular cleaning of your pool to remove any plant debris,
- In case of frequent use, consider using the boost function.



In the event of the water turning green, salt chlorination alone will not be sufficient, and supplementing with chlorine tablets may be required.

6. OPERATING LIMITS

Heat pump

As with any other heat pump, the one installed in the POOLICAN system may only be used when the outside temperature is between -7°C and 43°C; however, we recommend winterizing your pool if the water temperature drops below 10°C. Thanks to the Full Inverter system, POOLICAN automatically adjusts power depending on its settings and the external environment. Thus, when increasing water temperature (this phase may last up to a week after installation), POOLICAN will use all available power; and once the target temperature has been reached, POOLICAN will reduce its power consumption. Please note that as with any heat pump, and in order to limit power consumption, the pool should be covered when not in use, or an automatic pool cover installed, in order to limit heat losses due to evaporation. If this recommendation is not followed, it may affect power consumption and the target temperature.

Please note: some pool manufacturers recommend a maximum water temperature for their pools, for example:

- If using a liner pool, do not exceed the maximum temperature recommended by the manufacturer.
- If using a one-piece pool, do not exceed the maximum temperature recommended by the manufacturer.

For more information, contact your pool maintenance technician.

N.B.: Above 32°C, bacteria multiply more quickly.

Circulation / Filtration

As with any pool filtration equipment, it's extremely important that the time of circulation/filtration time is sufficiently long:

- To have well-filtered water,
- To reach and properly maintain water temperature,
- To obtain satisfactory water filtration levels.

As a general rule, the minimum theoretical filtration times are given by the following simplified formula:

$$\textit{Temps filtration (en heures)} = \frac{T^{\circ}\textit{eau}}{2}$$

Please note: above 25°C, extra filtration time is required (see page 21).

Consider winterizing your pool when temperatures drop below 15°C (see Chapter 12, page 30).

Your filter must be cleaned regularly (minimum of once per week); a CF warning will be displayed every 150h (adjustable from 130h to 200h).

To clean the filter, shut down the POOLICAN by setting it to OFF, and once stopped (after a period of around 3 minutes), open the cover to remove and clean the filter using a garden hose (make sure to clean well between each fold). Valves should be closed if your POOLICAN is installed below the water level (above ground pool).

Salt chlorination

As with any pool, it's important to maintain a good chemical balance in the water of your pool, including pH, alkalinity and water hardness.

The only special requirement to use a salt chlorinator is to maintain the proper levels of salt and stabiliser.

To get the most out of your pool, it is important to maintain these levels in order to avoid corrosion and scaling. It is therefore recommended that you test all of the basic parameters of the water at least once per week.

A test strip for these 6 parameters is provided.

In addition, we recommended getting your pool water tested by a professional at least twice per season. Your local pool store can provide you with the chemicals and steps you need to take to adjust the chemical properties of your water.

Don't forget to let them know that you use a salt chlorinator.

Readings to be taken weekly: test and adjust if necessary

Parameter	Target values	Comments
Salinity	3 to 4 g/l	Once the salt is in the water (taking 24 to 48h to fully dissolve), salt concentration will only vary slightly over the course of the season. In the event of excess salinity, partial draining of the pool may be necessary in order to add fresh water. Conversely, in the event of draining water or multiple backwashes of the filter, it may be necessary to add more (see Chapter 9).
pH level	7.2 to 7.8	Please note, a pH above 7.8 suppresses the disinfectant properties of hypochlorite.
Free chlorine concentration	From 1.0 to 3.0 ppm	Measurements must be taken from around the return jets when the chlorinator is switched on, preferably in the morning and out of direct sunlight. This is due to the fact that hypochlorite is relatively unstable, and UV light as well as high temperatures can lead to lower readings.
Stabiliser level (Cyanuric Acid)	From 20 to 50ppm	Hypochlorite is a relatively unstable disinfectant, and therefore when the stabiliser level is too low, hypochlorite reverts back to salt too quickly, without having enough time to properly disinfect. Conversely, when the stabiliser level is too high, the hypochlorite in the pool can become locked. Please note that if your stabiliser level is extremely high, it may be necessary to partially drain the water in your pool (see Chapter 12) in order to add fresh water without any stabiliser.
Additional tests		
Total alkalinity (TA)	From 80 to 150ppm	This level measures the concentration of mineral salts (carbonates, bicarbonates, hydroxides) in the water and allows the water balance to be stabilised / buffered. High TA levels interfere with the effects of pH regulation, and scale deposits may begin to appear; conversely, low TA levels will render pH regulation completely unstable and therefore uncontrollable.
Water hardness	From 150 to 300ppm	Water hardness represents the amount of calcium carbonate present in your water. High levels of water hardness can lead to scale deposits on equipment , which may require the removal of calcium from your water - please contact your pool maintenance technician for help with this step. Water hardness levels which are too low/high can also lead problems with water balance, resulting in unstable pH levels and rendering water treatment ineffective.

In addition, temperature (T°) plays a major role in the proper functioning of your chlorinator:

Water temperatures lower than 10°C will render the system inoperative (E7 warning will be displayed); in this case, consider winterizing your pool equipment.

Water temperatures higher than 32°C interfere with the effects of hypochlorite, and the use of chlorine tablets is recommended in the event of consistently high temperatures.

7. FEATURES

General information	
Max. pool volume ⁽⁴⁾	25 m ³
Power supply	230V-50 Hz
Max. power	1.25 kW
Max. current	6.63 A
Flow rate	3.5 m ³ /h
Connectors	32/38mm
Protection rating	IPX4
Temperature sensor	YES
Flow sensor	YES
Sound level at 10m ⁽³⁾	≤35 dB (A)

Salt chlorinator	
Salt concentration (g/l)	3 (g/l)
Hypochlorite production	2.5 & 5 (g/h)
Cell cleaning	Via reverse polarity
Operating mode	NORMAL & BOOST

Filtration	
D127 x H235 antibacterial filter	
Pureflow optional extra	

Heat pump		
Air ⁽¹⁾ 15°C Water ⁽²⁾ 26°C	Output power (kW)	3.5 kW
	Power consumption (W)	0.83 kW
	COP	4.2
Air ⁽¹⁾ 26°C Water ⁽²⁾ 26°C	Output power (kW)	5 kW
	Power consumption (W)	0.91 kW
	COP	5.5
Air ⁽¹⁾ 35°C Water ⁽²⁾ 27°C	Output power (kW)	2.3 kW
	Power consumption (W)	1.24 kW
	EER	2.0
Heating temperature range		15/40°C
Operating range		-7/43°C
Refrigerant		R32 / 0.33kg
Compressor type		Rotary
Operating mode		- Heating - Cooling - Automatic

Circulation	
Flow rate	3.5 m ³ /h
Power	0.75 hp

Technical specifications are listed for reference only; we reserve the right to change this data without prior notice.

¹ Ambient air temperature

² Initial water temperature

³ Noise at a distance of 10 m in accordance with international standards EN ISO 3741 and EN ISO 354

⁴ Calculated for a private pool equipped with a solar cover and located in a temperate climate.

Dimensions

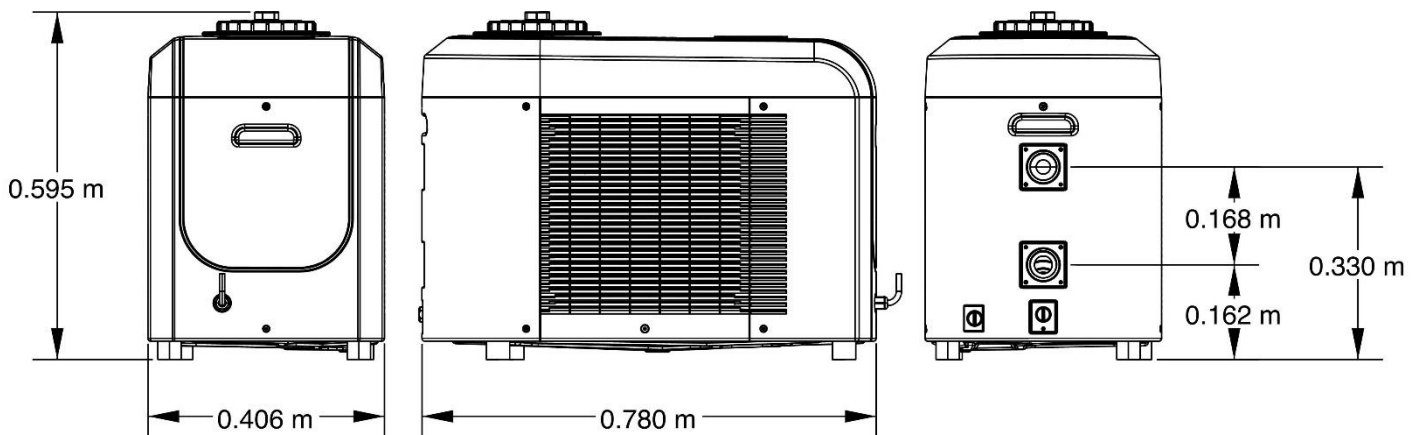

Exploded view

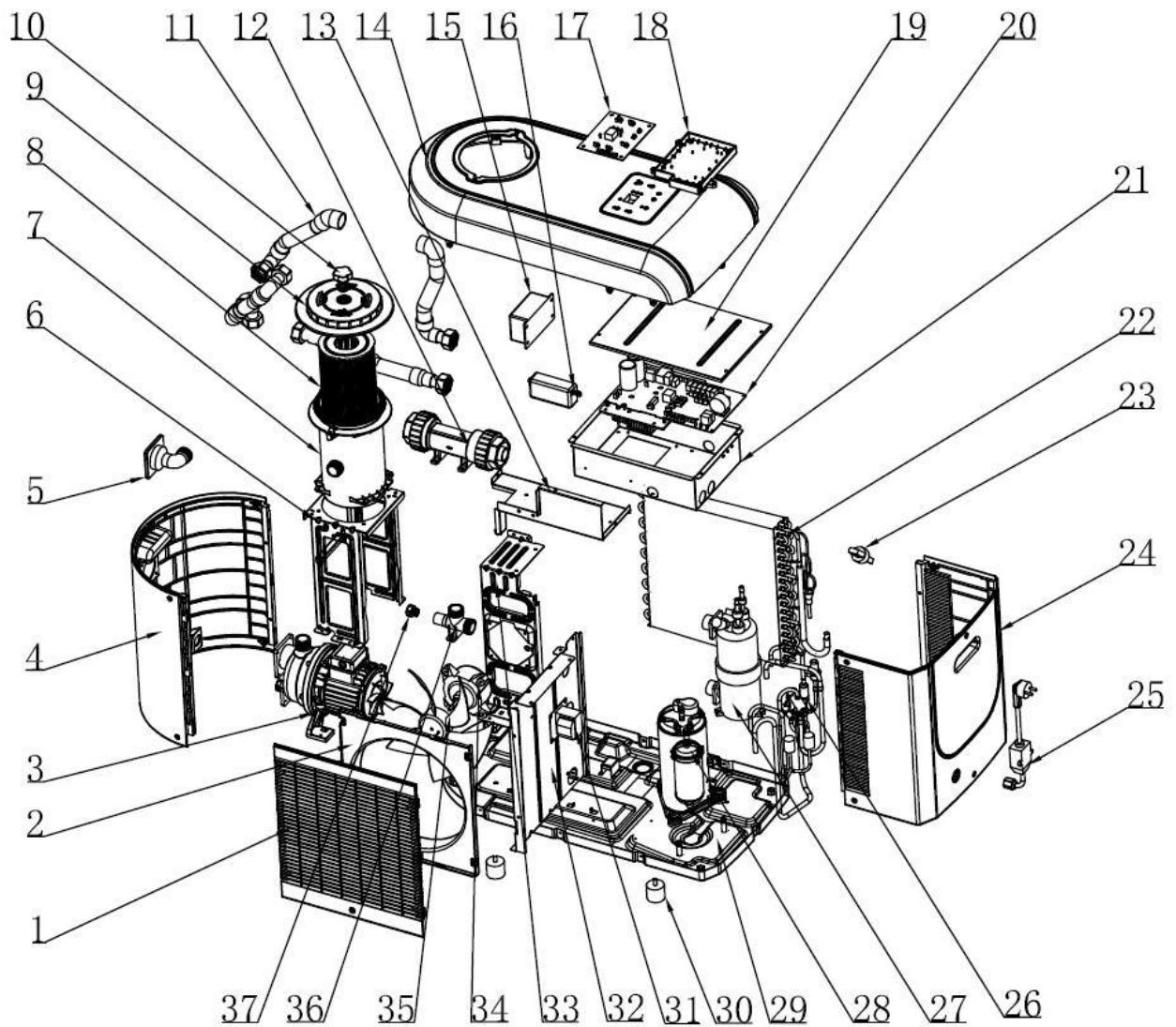

1	Grid panel	19	Motherboard cover
2	Deflector	20	Motherboard
3	Circulation pump	21	Motherboard housing
4	Rear panel	22	Evaporator
5	Water inlet internal connector	23	Flow sensor
6	Filter basket support frame	24	Front panel
7	Filter basket	25	Equipped power cable
8	Cartridge filter	26	Copper water pipe
9	Filter basket lid	27	Titanium heat exchanger
10	Suction valve	28	Rotary compressor
11	Internal connection pipes	29	Main frame
12	Salt chlorinator	30	Rubber feet
13	Salt chlorinator mount	31	Reactor
14	Top panel	32	Frame partition
15	Salt chlorinator control panel housing	33	Fan motor mount
16	Salt chlorinator power controller housing	34	Fan motor
17	Network adapter	35	Fan blade
18	Network adapter housing	36 & 37	Drain and drain plug

8. INSTALLATION

For more details about the kit, refer to Chapter 3.

POOLICAN must be installed between 2 and 3.5 metres from the pool basin:

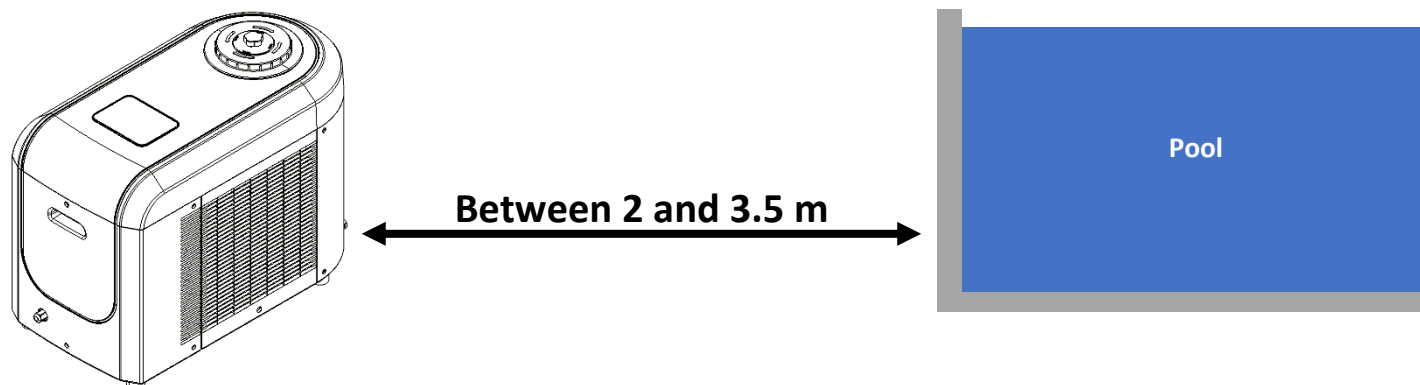

Please respect the following rules when choosing your installation location:

1. The location must be easily accessible for optimal operation and maintenance.
2. The device must be installed on the ground, ideally on a level concrete slab. Ensure that the ground is sufficiently stable and it can support the weight of the device.
3. Check that there is enough air flow, that the air exhaust is not directed towards the windows of neighbouring buildings, and that exhaust air cannot return to the intake. In addition, ensure that there is enough space around the device to perform servicing and maintenance.
4. The device must not be installed in locations susceptible of being exposed to oil, flammable gas, corrosive agents, sulphur compounds, or near high frequency devices.
5. Do not install the device near to roads or footpaths to avoid mud splattering.
6. To avoid disturbing neighbours, make sure to install the device facing away from areas sensitive to noise.
7. Keep out of the reach of children insofar as possible.
8. The electrical plug must not be exposed to heavy rain (IPX4 standard).

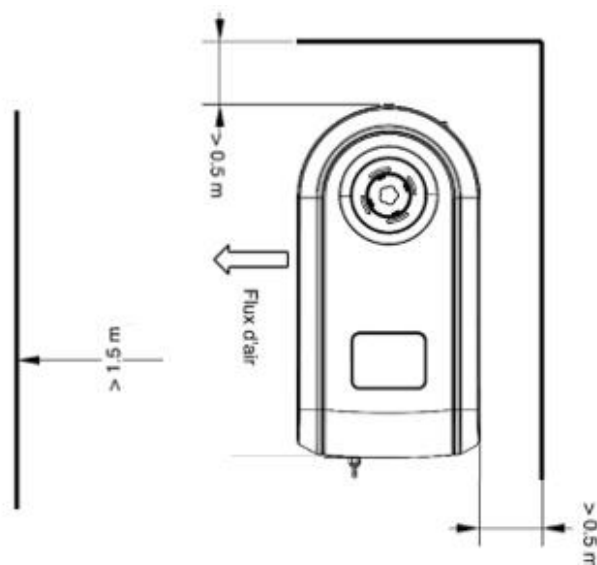

(Dimensions in m)



**Do not place anything within 1.5m of the front of the heat pump.
Leave at least 0.5m of empty space to the sides and rear of the heat pump.**

Do not place any obstacles on top or in front of the device!

Installation diagram

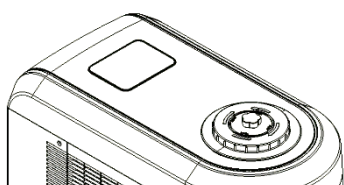

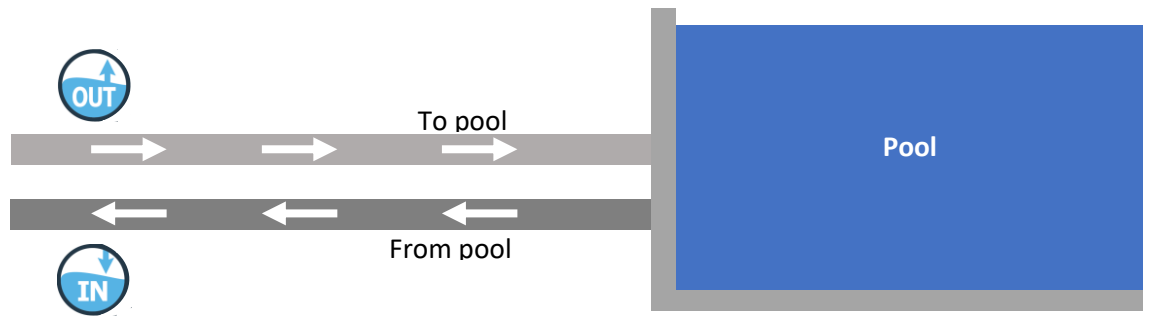



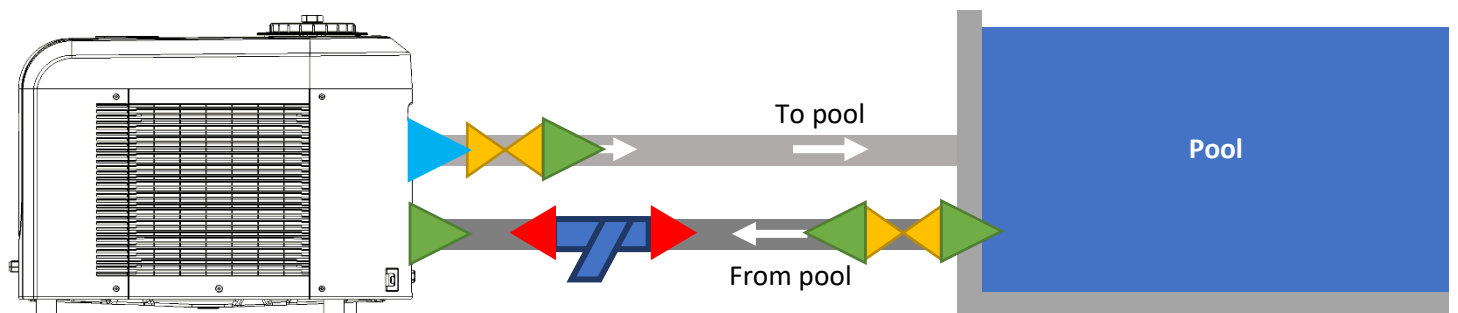

POOLICAN is an all-in-one system for your pool; simply connect the suction line from the pool to the POOLICAN inlet and the return line to the POOLICAN outlet.

Hydraulic connections



-  POOLICAN connectors: 1.5" to D32/38
-  2-position valve
-  Y strainer with internal mesh
-  D38/32 reducer fitting
-  Male 1.5" / Male 1.5" connector



Before any start-up, check that your filter is clean and remove any packaging that could prevent the proper functioning of the POOLICAN.



If your pool is not equipped with a skimmer, a larger strainer must be installed in place of the mesh strainer to improve system operation.

Starting the pump

Once the filter has been unpacked and all the hydraulic connections made. Before starting the circulation pump, check that the water can flow easily into POOLICAN. And this especially if POOLICAN is installed above the water level (often the case for installations on buried pools).

To do this, to ensure that the pump is primed, it is best to fill the filter basket until the water level stabilizes above the backflow hole of the filter. It will take about 5L of water, however, depending on your installation, the water will flow through the pipes, so do not hesitate to repeat the operation as much as necessary.

Once this level has been reached and stabilised, position the filter (unpacked) and close the lid securely.

When starting the pump be sure to leave the air bleed screw a little open to let the air escape, once the water replaces the air close this bleed screw.

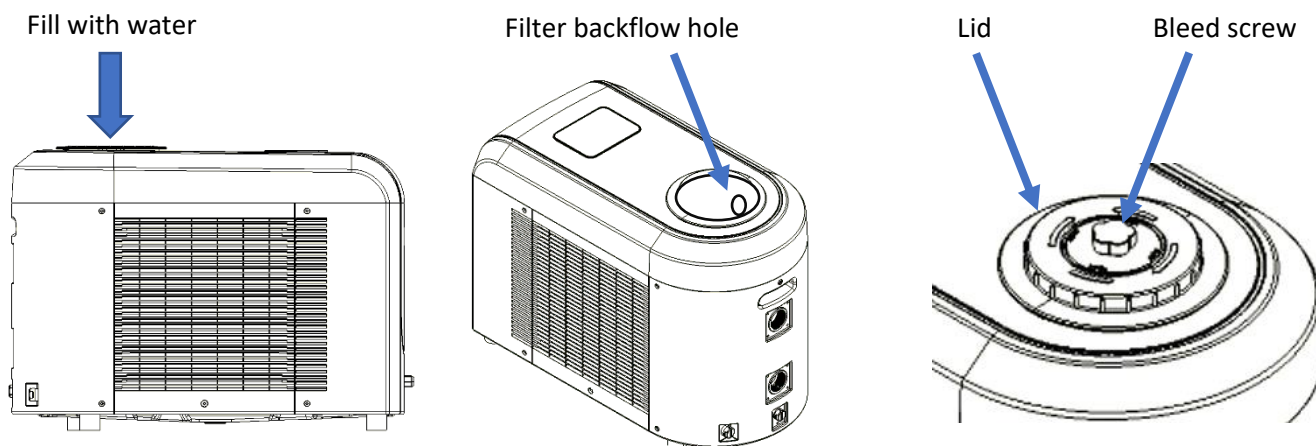

Electrical connections

POOLICAN's power plug integrates a 10mA RCBO.

Before plugging in your heat pump, ensure that the electrical socket is properly grounded.

Installation and maintenance of any upstream electrical components must be performed by a qualified electrician. Failing to do so may result in electric shock, serious injury, property damage, and even death.

Light on: indicates there is power.

Pressing "test" simulates a power cut.

Pressing "RESET" allows the power to be switched back on.

The "test" and "RESET" functions should be tested every month.

The power plug must not be exposed to heavy rain (IPX4 standard).

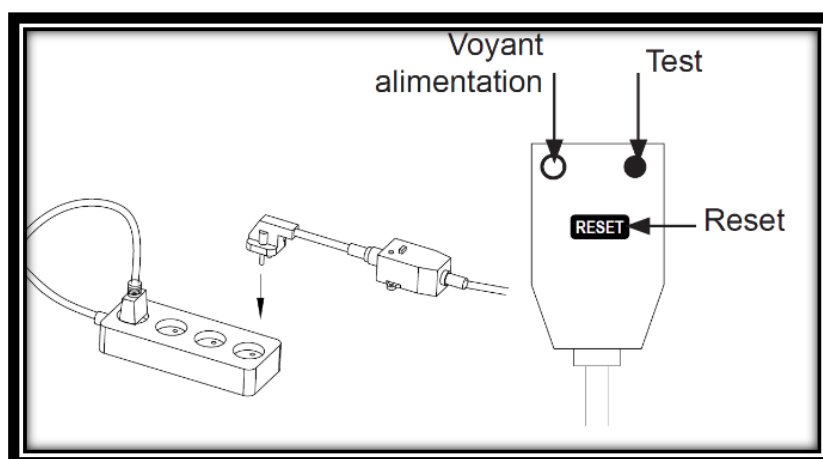

9. BEFORE USE

Adding salt



Prior to adding salt, **ALWAYS** test the salinity.

Only use salt which complies with European standard EN 16401 to extend service life and improve efficiency of the chlorinator cell.



DO NOT ADD chemical products or salt directly into the skimmer. This can damage the cell.

Do not switch on the chlorinator before the salt has fully dissolved.

When adding salt, it's preferable to pour the salt into the deepest part of the pool, then switch on the filter pump to circulate the water and dissolve the salt (**the cell must remain switched off during this time**).

In summer, salt may take **24 - 48** hours to fully dissolve, and **even longer in winter**.

Do not place the plastic bag of salt directly into the water as the chemicals and inks on the bag can interfere with water balance. Make an opening in the bag, empty its contents into the pool, and then dispose of the bag in a waste bin.

Required salt levels

The system can operate with a wide range of salinities, from a minimum of 2,700 ppm (parts per million) up to 4,500 ppm. However, the ideal salinity level for the water is around 3000 ppm.

To achieve this salinity level, add around 3 kg of salt per 1 m³ of water (or 30 pounds of salt per 1,000 gallons of water).

USEFUL TIP: When adding large quantities of salt, always start by testing the salinity of the water and then gradually adding salt, **testing the concentration as you go**.

If you're unsure of the volume of your pool (m³), you can calculate it using the following equations:

- Rectangular pool: Length x Width x Average Depth
- Round pool: Diameter x Diameter x Average Depth x 0.80
- Oval pool: Length x Width x Average Depth x 0.90

Before adding salt, test your water to measure salt concentration, then add the corresponding quantities according the table below (next page).

If insufficient salt is added, efficiency is reduced and the level of chlorine production will be too low.

The salt in your pool is constantly recycled, limiting the amount of salt lost during a bathing session. Losses are mainly due to the addition of fresh water replacing water lost as a result of splashes, run-off, filter cleaning, and drainage.

Salt is not lost through evaporation.



In the event of excess salinity (> 4.5 g/l or 45 kg/m³), partial emptying of the pool may be necessary in order to add fresh water without salt. Furthermore, the correct stabiliser level must be between 20ppm and 50ppm. In the event it exceeds these values, partial draining of the pool may be necessary in order to add fresh water without stabiliser.

Quick reference table for adding salt according to the salinity measured prior to installation:

	Salinity before adding salt (PPM)							
	0	500	1000	1500	2000	2500	3000	
Volume in m ³	Amount of salt required (kg)							
10	30	25	20	15	10	5	0	
15	45	38	30	23	15	8	0	
25	75	62	50	38	25	13	0	

	Salinity before adding salt (PPM)							
	0	500	1000	1500	2000	2500	3000	
Volume in thousands of gallons	Amount of salt required (pounds)							
2.5	65	55	45	33	22	11	0	
4	100	84	65	50	33	17	0	
6.5	165	137	110	84	55	28	0	

Required stabiliser levels

Hypochlorite remains effective if the stabiliser level is between 20 and 50 ppm.

A lack of stabiliser reduces disinfection efficiency due to the hypochlorite reverting back to salt too quickly. Conversely, stabiliser levels which are too high effectively nullify its capacity to disinfect; the stabiliser locks up the hypochlorite and renders it useless.

Thus, in order to reach this level of stabiliser, add a little stabiliser but be careful not to add too much (refer to the instructions which come with the stabiliser sold separately): target 20 ppm < stabiliser level < 50 ppm

If you're unsure of the volume of your pool (m³), you can calculate it using the following equations:

- Rectangular pool: Length x Width x Average Depth
- Round pool: Diameter x Diameter x Average Depth x 0.80
- Oval pool: Length x Width x Average Depth x 0.90

Before adding stabiliser, test your water to measure its current concentration, then add the corresponding quantities according the instructions provided.





Please note that stabiliser is not lost through evaporation. In the event of adding excess quantities, partial draining of the pool may be necessary.

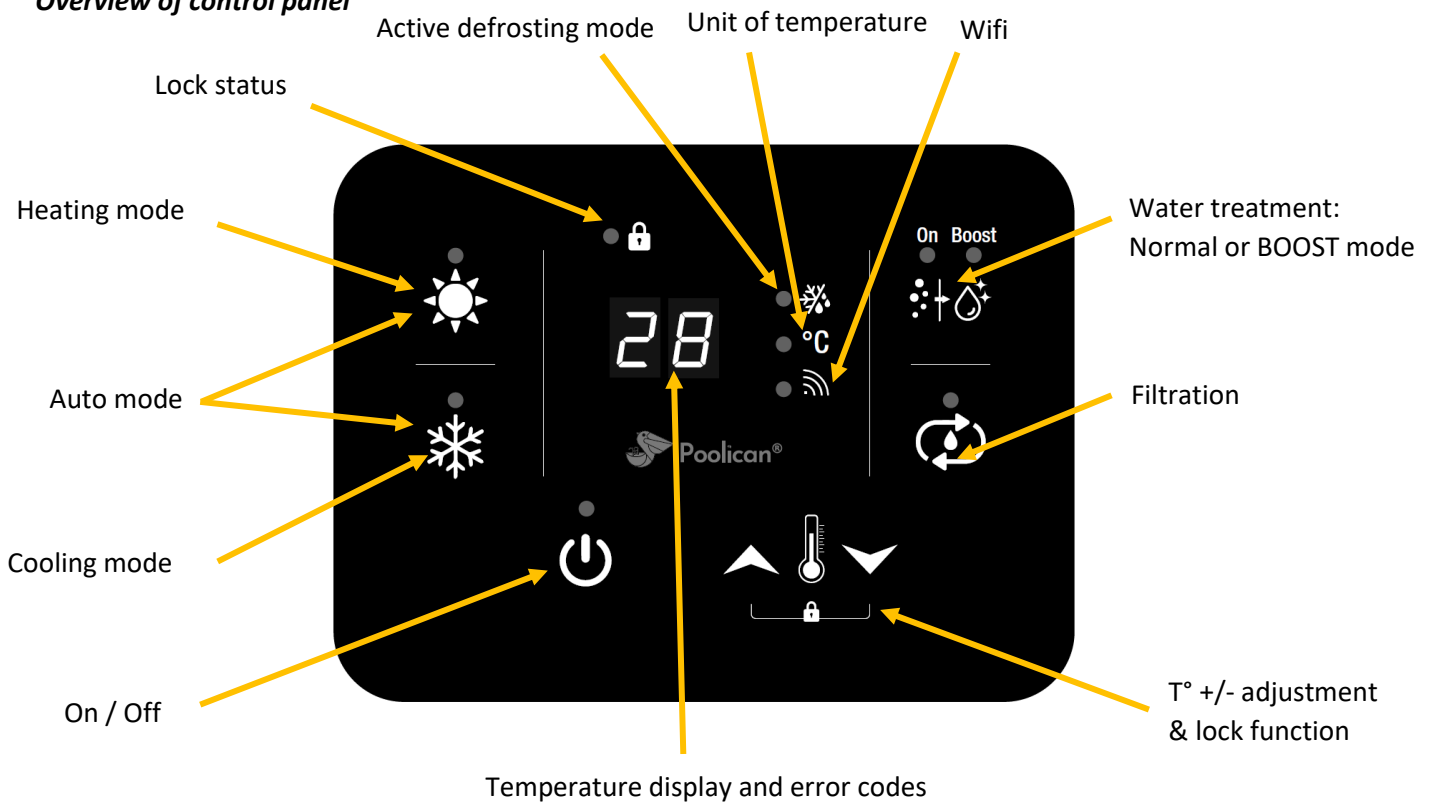

10. USING THE CONTROL PANEL

Overview of control panel





Button functions and usage

 **Power on (start up) and power off (shut down) button.**
 When switching on the POOLICAN, the green light is displayed; we recommend to leaving the POOLICAN switched on throughout the season so it can automatically manage your pool water.
 If Wifi is connected, the Wifi light will turn green.
 If the unit of temperature is degrees Celsius, this light will turn green.  

 **Filtration start up button.** When starting up the filtration system, it will run for a set amount of time (by default 8h) every 24h (ensure that the POOLICAN is plugged in and switched on).
 However, this is the minimum amount of run time, and due to the heat pump requiring more time to reach and maintain its target temperature, the circulation pump will also run continuously during this time. When the heat pump is off, the preset filtration time will be used.

 **Salt chlorinator start up button.** Pressing this button will cycle through the modes.
 1st press = BOOST, 2nd press = ON (normal), and 3rd press = OFF, then the cycle repeats.
 When starting up the water treatment system in normal mode, chlorine production (at 2.5 g/h) will begin for a set amount of time (by default 8h) every 24h; POOLICAN will repeat this cycle every day.
 When starting up the water treatment system in BOOST mode, chlorine production (at 5 g/h) will begin for a set amount of time (by default 8h) every 24h; at the end of the BOOST, POOLICAN will return to normal mode.

 **Button for switching to heating / cooling / auto mode.**
 The POOLICAN heat pump has 3 operating modes which can be selected using the specific hot and cold buttons (their respective lights will turn green depending on the selected mode); to switch to automatic mode, simply press and hold both buttons (hot + cold) for 3 seconds, both lights will turn green.

 **Temperature adjustment button** (in 1°C increments) available after selecting the desired mode.

Easy to use in four simple steps

1 – Calculate the volume of your pool and make a note of it here:

⇒ Check your salinity level (see Chapter 9)

2 – Choose your desired bathing temperature and make a note of it here:

3 – Calculate filtration time (in hours) (**C_B**) and make a note of it here:

C_B =

4 – Calculate water treatment time (in hours) (**C₉**) / BOOST time (in hours) (**C_A**) and make a note of them here:

C₉ =

C_A =

5 to 10 m³ pool:

T°C	<20°	25	26	27	28	29	≥30	BOOST (C_A)*
Filtration time (C_B)*	5	18			24			24
Water treatment time (C₉)*	1	2	3		4		5	5

10 to 15 m³ pool:

T°C	<20°	25	26	27	28	29	≥30	BOOST (C_A)*
Filtration time (C_B)*	5	18			24			24
Water treatment time (C₉)*	2	4	6		8		10	10

15 to 20 m³ pool:

T°C	<20°	25	26	27	28	29	≥30	BOOST (C_A)*
Filtration time (C_B)*	5	18			24			24
Water treatment time (C₉)*	3	6	9		12		15	15

20 to 25 m³ pool:

T°C	<20°	25	26	27	28	29	≥30	BOOST (C_A)*
Filtration time (C_B)*	5	18			24			24
Water treatment time (C₉)*	4	8	12		16		20	20

* The settings given above are for reference only. You can adjust your settings depending on your personal experience. Please note that filtration time must always be longer than water treatment time: **C₉** < **C_B**.





Covered mode

If your pool is equipped with a pool cover / solar cover, and the pool is not in use for prolonged periods of time (> 3 days), make sure to reduce the water treatment time **C9** (see table on page 22). Covering pools for prolonged periods of time may result in over-chlorination.

Setting the desired temperature

The POOLICAN heat pump can be used in 3 different modes to better suit your needs:

 **HEATING (Full Inverter):**
This mode heats your pool water to between 15 and 40°C; by default the target temperature is 28°C.
N.B.: when starting the heating process, it may take up to 6 days to reach the desired temperature. Be careful not to exceed the maximum temperature recommended by the manufacturer for your pool liner (seek advice from a pool maintenance technician).

 **COOLING (Full Inverter):**
This mode cools your pool water to between 8 and 30°C; by default the target temperature is 28°C.
This mode can ensure that you do not exceed the maximum temperature recommended by the manufacturer for your pool liner (seek advice from a pool maintenance technician).

 **AUTOMATIC (Full Inverter):**
This mode allows you to set a target temperature and POOLICAN will automatically select the operating mode in order to maintain the temperature within +/- 2°C of the target. Temperature range between 8°C and 40°C; by default the target temperature is 28°C. This mode can ensure that you do not exceed the maximum temperature recommended by the manufacturer for your pool liner (seek advice from a pool maintenance technician).

The Full Inverter system allows the power consumed by the Heat Pump (HP) to be adjusted depending on the desired temperature. During the heating phase, the HP will use its full available power until the target temperature is reached, and then enter a temperature maintenance phase where it will automatically regulate its power consumption.

 In each of these modes, the target temperature to be reached can be set by pressing the up and down arrows. The HP will maintain the temperature within +/- 2°C of the target.

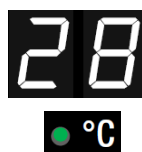
 By default, the temperature is displayed in °C (Celsius) and the green light will be displayed; otherwise the unit of temperature is °F (Fahrenheit)

 When the heat pump is in use, it may occasionally switch to an evaporator defrosting phase to ensure optimal performance. During this defrosting phase, the defrosting light will turn green. This phase is a normal part of operation and will automatically terminate.

In order to effectively manage the temperature throughout the day, when the heat pump is operating in one of the modes listed above, the circulation pump will also remain on 24/7.

Setting filtration time

The filtration time can be adjusted when the POOLICAN heat pump is not in use.

To ensure optimal filtration, the filtration time of the POOLICAN system must be sufficiently long. A simple formula is given below as a guideline:

$$\text{Temps filtration} = \frac{T^{\circ}\text{eau}}{2}$$

However, when the water temperature is above 25°C, we recommend significantly increasing filtration time such that filtration is on 24/7 once the water temperature exceeds 28°C.

Water temperature	15°C ~ 20°C	20°C ~ 25°C	25°C ~ 28°C	28°C and above
Filtration time = C8	10h	12h	18h	24h

The settings given above are for reference only; you can adjust your settings depending on your personal experience.

Please note that filtration time must always be longer than water treatment time: **C9 < C8**.

For water temperatures <15°C, we recommend winterizing your POOLICAN (see chapter 12).



By default, filtration time is set (**C8**) to 16h.

To adjust filtration time and achieve adequate filtration, modify the **C8** parameter.

This can be done in two ways: either using the control panel, or through the app (see chapter 11).

Adjusting parameters using the control panel

To change these parameters, turn off the power to the POOLICAN =>  Button indicator light is off

Once the POOLICAN has completely shut down (wait for all of the components to stop; this can take 2 to 3 minutes), then press and hold both the Heating & Down Arrow for 3 seconds:  + 

C1 will flash on the screen.

You can now use the arrows  to select the desired parameter **C8**

Confirm by pressing the chlorinator button,  the set value will then be displayed, e.g., **16**

You can now use the arrows  to selected the desired filtration time, e.g., **18** for 18h.

Confirm by pressing the chlorinator button.



Setting water treatment time (in hours)

Setting the correct water treatment time (or chlorine production time) is extremely important to achieve adequate disinfectant levels and avoid over-chlorination.

The settings given below are for reference only; you can adjust your settings depending on your personal experience. Please note that filtration time must always be longer than water treatment time: $\text{C9} < \text{C8}$.

Regularly test (weekly) free chlorine levels (following the instructions on page 10).

Normal time = C9	Off-season	Spring	Peak season	Summer	Comfort
Volume \ Water T°	10°C ~ 20°C	20°C ~ 25°C	25°C ~ 28°C	28°C ~ 30°C	30°C and above
5 m ³ to 10 m ³	$\text{C9} = 1$	$\text{C9} = 2$	$\text{C9} = 3$	$\text{C9} = 4$	$\text{C9} = 5$
10 m ³ to 15 m ³	$\text{C9} = 2$	$\text{C9} = 4$	$\text{C9} = 6$	$\text{C9} = 8$	$\text{C9} = 10$
15 m ³ to 20 m ³	$\text{C9} = 3$	$\text{C9} = 6$	$\text{C9} = 9$	$\text{C9} = 12$	$\text{C9} = 15$
20 m ³ to 25 m ³	$\text{C9} = 4$	$\text{C9} = 8$	$\text{C9} = 12$	$\text{C9} = 16$	$\text{C9} = 20$

Normal time if the pool is covered for more than 3 consecutive days.

Normal time = C9	Covered pool
Volume \ Water T°	< 20°C
5 m ³ to 10 m ³	$\text{C9} = 1$
10 m ³ to 15 m ³	$\text{C9} = 2$
15 m ³ to 20 m ³	$\text{C9} = 3$
20 m ³ to 25 m ³	$\text{C9} = 4$

During occasional periods of high-demand (high T°, intensive use, etc.)

Normal time = CA	Frequent use
Volume \ Water T°	BOOST
5 m ³ to 10 m ³	$\text{CA} = 5$
10 m ³ to 15 m ³	$\text{CA} = 10$
15 m ³ to 20 m ³	$\text{CA} = 15$
20 m ³ to 25 m ³	$\text{CA} = 20$

BOOST time = CA

Reverse polarity time = CC

Reversing polarity allows the cell to be “cleaned”; more specifically this function prevents calcium deposits on the plates and scale build-up in the cell. By default, the reverse polarity time is set to 4h.

However, for soft or very soft water, this time can be extended to 6 or 8h.

Water hardness	Total hardness (TH) of water	Reverse polarity time
Hard to normal	TH > 150 ppm	$\text{CC} = 4\text{h}$
Soft	8 < TH < 150 ppm	$\text{CC} = 6\text{h}$
Very soft	TH < 70 ppm	$\text{CC} = 8\text{h}$

This can be done in two ways: either using the control panel (see previous page: "Adjusting parameters using the control panel") or through the app (see paragraph 11).

11. USING THE APP

In order to simplify the use of the POOLICAN system, an app is available on the Android Google Play store and the iOS App Store.

Before beginning, ensure that the POOLICAN is within Wifi range of your router; a Wifi repeater may be required to provide sufficient signal to the POOLICAN installation site.

Download the Tuya smart or Smart life app:



Tuya Smart App



Smart Life App

Connecting the app to Wifi

To connect to Wifi, first turn off the power to the POOLICAN =>  Button indicator light is off

Once the POOLICAN has completely shut down (wait for all of the components to stop; this can take 2 to 3 minutes), then press and hold both the Power & Up Arrow for 3 seconds:



The Wifi light will flash:



Now launch the application, add the device, and enter your Wifi login details:

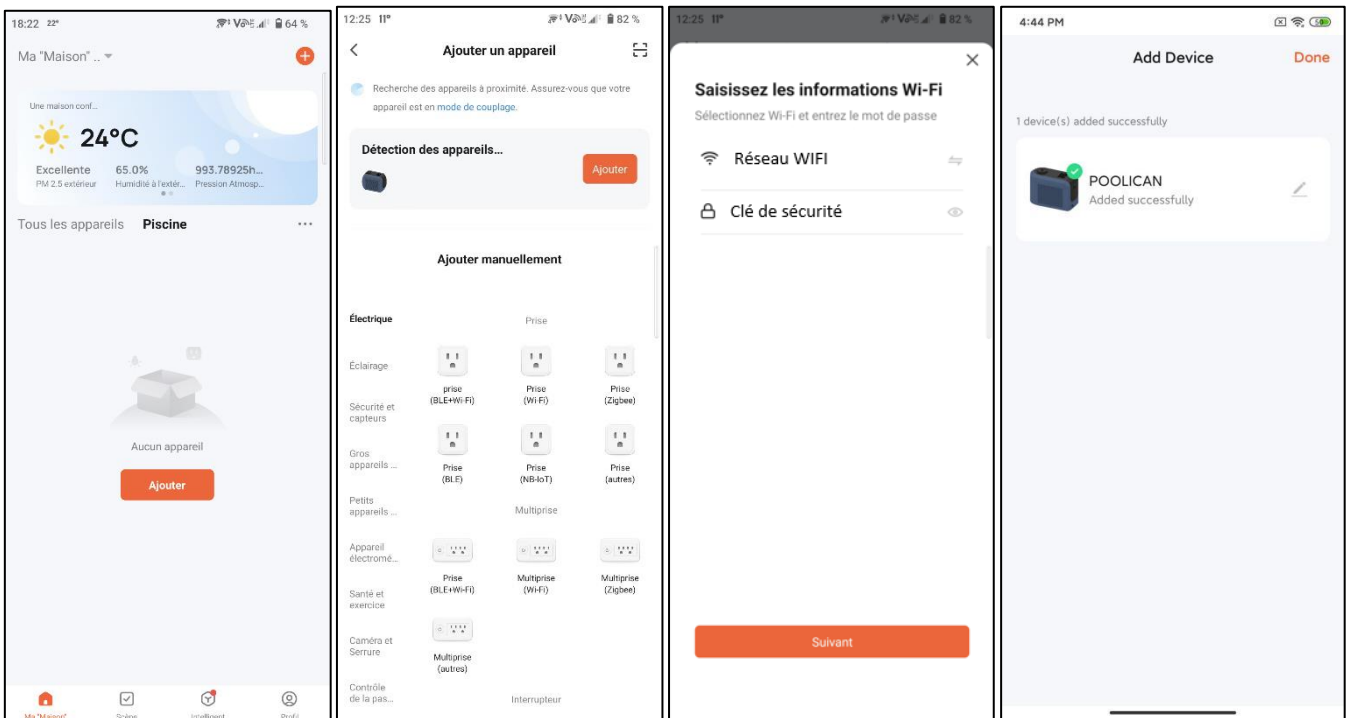

Once installed by the main user, user access to the product should only be shared with a technician.

Any new installation on another device will remove permissions from the previous device.

To share a product, navigate to the page where the product name can be changed to view additional options.

Overview of the application control panel

The screenshot shows the POOLICAN application interface. At the top, there is a back arrow, the title 'POOLICAN', and a settings icon. Below the title is an 'Auto' button. A defrosting icon (snowflake) is visible. A lock icon and a toggle switch are also present. The main display features a large circular temperature gauge showing '28 °C' and 'Température entrée d'eau 15°C'. Below the gauge are minus and plus buttons for temperature adjustment, and a 'Réglage température °C' label. At the bottom, there are five icons: a power button, a sun icon, a refresh icon, a salt chlorinator icon, and a cube icon. Two callout boxes provide detailed views of the heat pump and salt chlorinator settings.

Heat pump operating mode indicator

Change device name (and other functions)

Defrosting indicator, only appears when the device is defrosting

Lock the control panel

Target temperature indicator

Water temperature indicator

Set temperature using the slider

Set temperature by pressing +/-

On/Off button

Additional settings

Change heat pump mode

Filtration indicator

Salt chlorinator settings

Normal mode

BOOST mode

Froid
Chaud
Auto
OFF <input checked="" type="checkbox"/>
Valider

ON
BOOST
OFF <input checked="" type="checkbox"/>
Valider

Change operating parameters

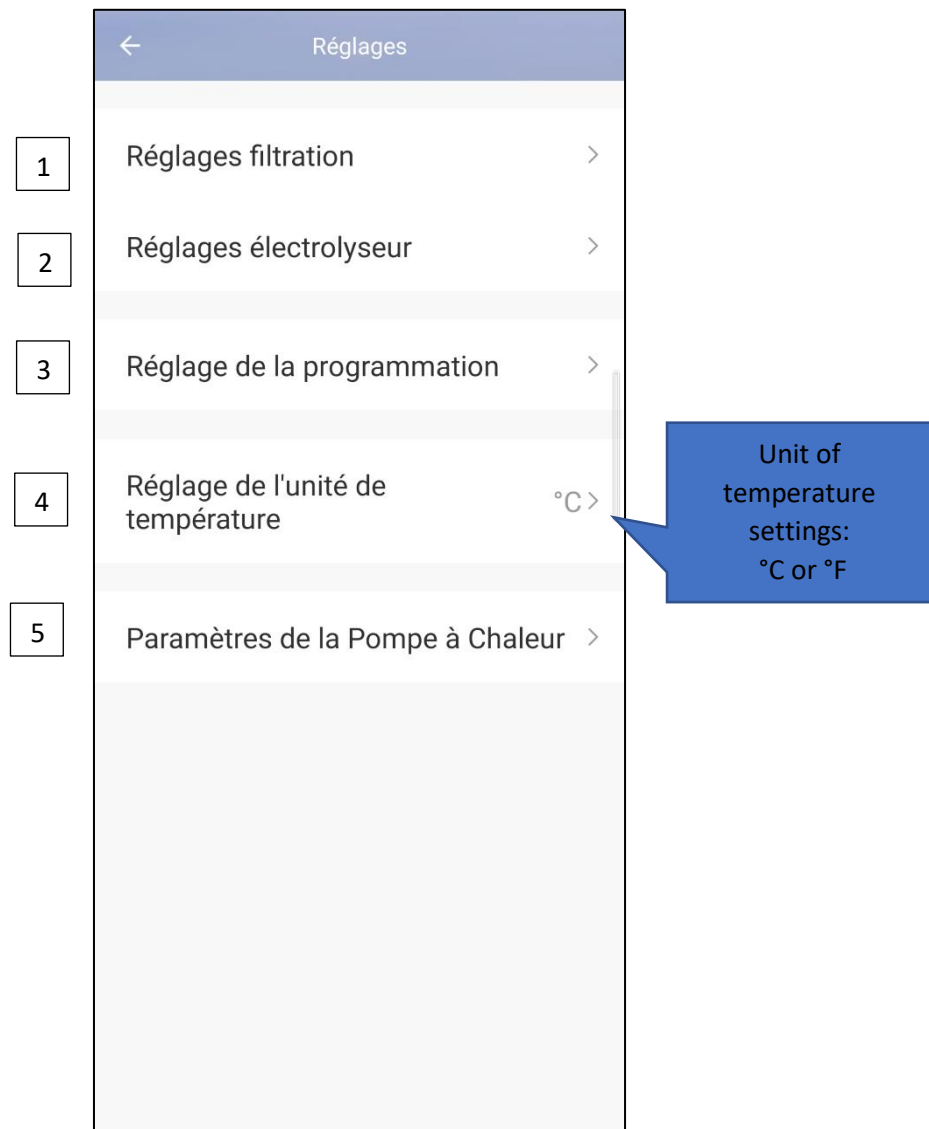

1 Filtration settings

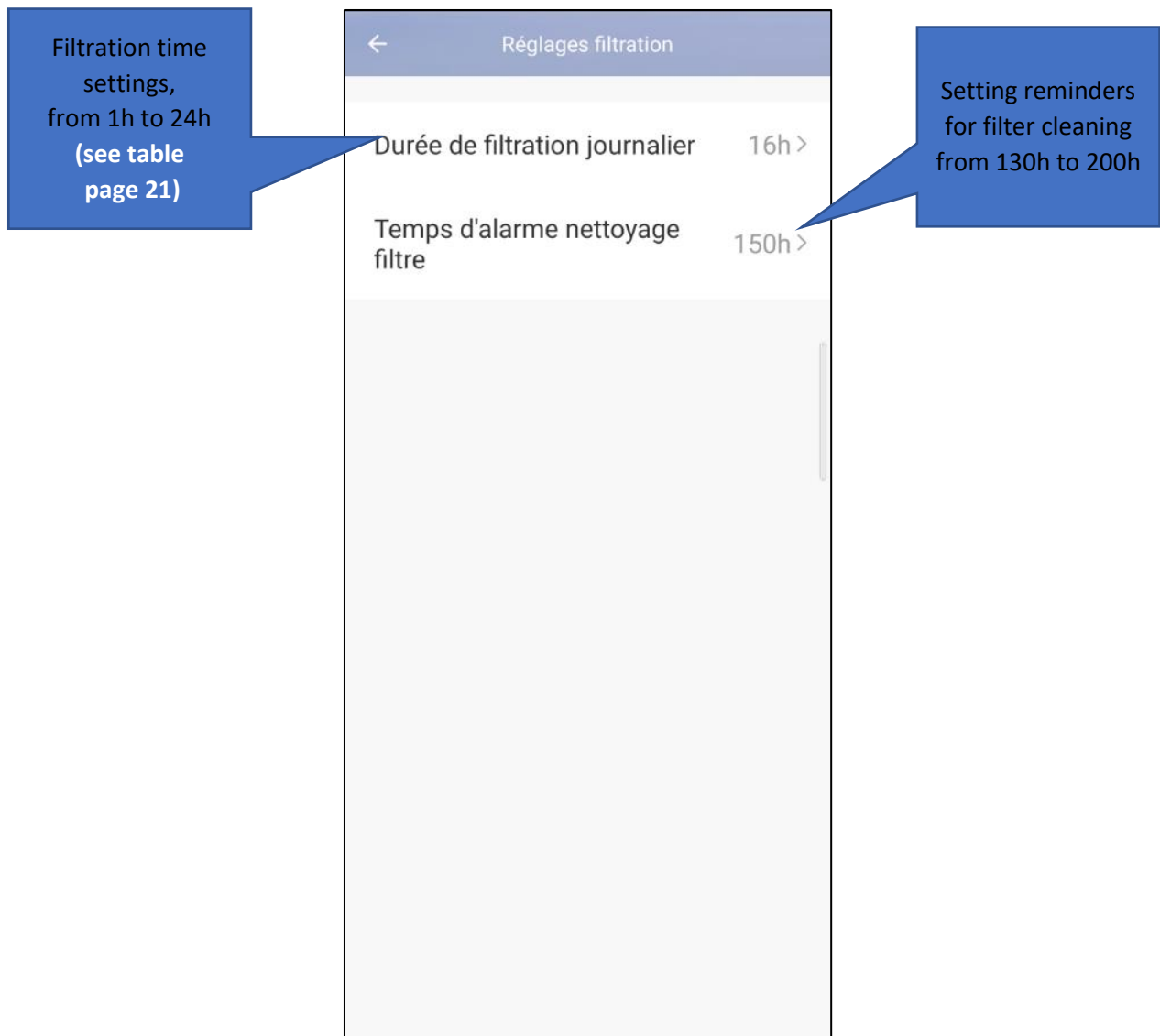

2 Water treatment settings

The screenshot shows the 'Réglages électrolyseur' screen with the following settings:

- Temps normal de traitement journalier: 8h >
- Durée du BOOST: 8h >
- Durée du cycle d'inversion de polarité: 4h >

Callouts explain the settings:

- Setting water treatment time, 1h to 24h (see table page 22)
- Setting water treatment boost time, 1h to 24h (see table page 22)
- Setting reverse polarity time (chlorinator cleaning), 4h, 6h, or 8h

3 Programming a schedule

The screenshots show the 'Schedule' and 'Add timing' screens with the following callouts:

- Activates an existing program
- Timer setting, allow 2 minutes for the program to be saved to the cloud
- Repeat: once by default, select the days in question
- Program settings to be activated or disabled
- Add new program

The 'Add timing' screen shows a table for setting the schedule:

Start Time	End Time
19	22
20	23
21	24
22	25
23	26
24	27

Below the table, the 'Repeat' setting is set to 'Once >'. The 'POWER' setting is set to 'ON >'. The 'Mode de la pompe de...' setting is set to 'ON >'. The 'Mode de la pompe à...' setting is set to 'Froid >'. The 'Mode de l'électrolyseur' setting is set to 'ON >'. A blue arrow points from the 'ON >' setting to the legend below.

POWER: ON / OFF
If OFF, everything else is set to OFF
FILTRATION: ON / OFF
HEAT PUMP: Hot / Cold / Auto / OFF
CHLORINATOR: ON / BOOST / OFF

4 Verification of heat pump parameters (indicators only)

The image shows a screenshot of a mobile application interface titled "Paramètres de la Pompe à Chale...". The interface lists several parameters with their corresponding values. Blue callout boxes point to specific parameters, providing their English names. The parameters and their values are as follows:

Parameter (French)	Value	Indicator Name (English)
Température air ambiant	8°C	Outside air temperature indicator
Température entrée d'eau	20°C	POOLICAN water inlet temperature indicator
Température sortie d'eau	22°C	POOLICAN water outlet temperature indicator
Température de sortie compresseur °C	48°C	Compressor gas discharge temperature
Température entrée compresseur °C	0°C	Compressor gas suction temperature
Fréquence du compresseur	0	Compressor frequency indicator
Détecteur de débit	Normal	Water flow status indicator
Vitesse du ventilateur	0	Fan speed indicator
hist_erreur_1		List of errors in chronological order of appearance (only the last 5)
hist_erreur_2		
hist_erreur_3		

12. MAINTENANCE, SERVICING AND WINTERIZING

Cleaning

The heat pump housing must be cleaned with a damp cloth. Using detergents or other household cleaning products may degrade the surface of the housing and affect its integrity.

Regular maintenance

Check that nothing is obstructed the grills.

Check the condition of the water pipes and ensure they are securely connected.

Check the condition of the power cable and ensure it is securely connected.

Check the condition of the filter and clean the filter if necessary (a CF warning will be displayed every 150 hours as a reminder to clean the filter):

- Power OFF, wait 2 to 3 minutes for everything to shut down (do not close the valves or open the cover/remove plugs until the circulation pump has come to a complete stop)
- Close the valves
- Clean the Y strainer
- Unscrew the lid of the filter
- Remove the filter from its enclosure
- Check the condition of the filter and clean it.

Replacing the filter:

We recommend replacing used filters at least once per season depending on the maintenance performed on your POOLICAN

Draining

Draining may be required in order to winterize your pool, or in the event of excess salt or stabiliser.

- Close the valve of the water return line to the pool.
- Remove the hose clamp connecting the valve to the Y strainer on the valve side.
- Open the valve to evacuate the water into a drain.

In order to know whether the water contains too much salt or stabiliser, and therefore whether the pool water needs to be drained, regularly test these levels using one of the various test strips available on the market or seek advice from your pool maintenance technician.

Winterizing

Your heat pump is designed to operate in all weather. However, we recommended not leaving it outside for prolonged periods of time, in particular during winter.

In the off-season, when the ambient temperature is below 10°C, the POOLICAN must be switched off and winterized to avoid any damage caused by freezing.

To do this:

- Switch off the power to the POOLICAN heat pump.
- Drain the water from the pool or close the circulation valves. If you intend on keeping the water in the pool, we recommend covering your pool.
- Disconnect the water suction line and return line from the POOLICAN.
- Drain the remaining water from the POOLICAN by opening the two drain plugs.
- Screw the drain plugs back into the device and conduits, or plug them using a rag into to prevent foreign objects from entering the device through the pipework.
- Store the POOLICAN in a clean and dry place.

When restarting the POOLICAN, your pool water must be clean (no algae or debris, etc.) and, if necessary, the water must be replaced and the salinity tested and adjusted.

13. BREAKDOWN AND FAULTS

Fault code	Description	Comments
CF	Reminder to clean the filtration system	Clean or check the filter. RAZ up arrow + filtration
d1	Water flow switch protection	Check that water is properly flowing through the pipes, ensure the filter is clean, and the inlet/outlet valves are open.
	Water flow switch protection	If this does not solve the problem, contact customer support to reconnect or replace the flow sensor
d2	Fault in the water inlet temperature sensor	Contact customer support to reconnect or replace the sensor
d4	Fault in the water outlet temperature sensor	Contact customer support to reconnect or replace the sensor
db	Water temperature protection (Antifreeze Level 1)	This protective measure is triggered when the water temperature is too low and the device is on standby: No intervention is required; consider winterizing the POOLICAN. Clears by itself once the temperature returns to normal.
	Antifreeze Level 2	This protective measure is triggered when the water temperature is too low and the device is on standby: No intervention is required; consider winterizing the POOLICAN
dB	Significant difference between the water temperature at the inlet and the outlet.	Check that water is properly flowing through the heat pump, ensure the filter is clean, and the inlet/outlet valves are open. Contact customer support to reconnect or replace the sensor.
E0	Internal and external communication failure	Automatically clears (switch the POOLICAN off and on again)
E3	Fault in the tube water temperature sensor	Contact customer support to reconnect or replace the sensor
E4	System exception	Automatically clears (switch the POOLICAN off and on again)
E7	Fault in the temperature sensor on the outer ring	Contact customer support to reconnect or replace the sensor
EB	Fault in exhaust sensor	Contact customer support to reconnect or replace the sensor
E9	Internal error	Automatically clears (switch the POOLICAN off and on again)
EC	Failure to communicate with the control board	Automatically clears (switch the POOLICAN off and on again)
EE	Fault in electronic communication system	Automatically clears (switch the POOLICAN off and on again)
EF	DC fan malfunction	Clears after 3 attempts to restart every 10 minutes (if problem persists, contact customer support)
EH	Gas suction sensor fault	Contact customer support to reconnect or replace the sensor
EP	Upper housing protection	Automatically clears (switch the POOLICAN off and on again)
EU	Voltage sensor fault	Contact customer support to reconnect or replace the sensor
F1	Unable to communicate with the chlorinator	Automatically clears (switch the POOLICAN off and on again). If the problem persists, contact customer support to check the connections of the chlorinator output cables
F2	Too much salt	High salinity/Too much salt added/Drain water (see maintenance). Disappears once salinity returns to normal.
F3	Lack of salt	Low salinity/Not enough salt in water/Add salt (see maintenance). Disappears once salinity returns to normal.
F4	Electrode malfunction (must be manually cleared)	Contact customer support for cell cleaning

F5	System detection circuit malfunction (must be manually cleared)	Automatically clears (switch the POOLICAN off and on again). Contact customer support if problem persists
F6	Abnormal temperature range of the water in the chlorinator	Check the water temperature is not below 10°C or above 40°C (if necessary, winterize the POOLICAN or cool down the water using the cooling mode)
H1	High pressure protection	Clears after 3 attempts to restart every 30 minutes (if problem persists, contact customer support)
H2	Low pressure protection	
P1	AC low voltage protection	Automatically clears (switch the POOLICAN off and on again)
P2	Overcurrent protection	Automatically clears (switch the POOLICAN off and on again)
P3	System protection	Switch the POOLICAN off and on again, if problem persists contact customer support
P4	Exhaust temperature is too high	Contact customer support to check gas pressure.
P5	Refrigeration fault and undercooling during self-cleaning	Switch the POOLICAN off and on again, if problem persists contact customer support
P6	External refrigeration coil is too high	Switch the POOLICAN off and on again, if problem persists contact customer support
P7	Overheat protection	Switch the POOLICAN off and on again, if problem persists contact customer support
P8	Outside ambient temperatures is too high and protection too low	Cool down the surrounding environment of the POOLICAN, limit direct sunlight (put in shade)
P9	Internal protection	Automatically clears (switch the POOLICAN off and on again)
	Compressor operation fault	
	IPM overcurrent	
	Compressor not responding to inputs	
	Compressor overcurrent	
	Input voltage error	
	IPM current sampling fault	
	Shut down due to overheating	
	Logic preload failure	
	DC bus overvoltage	
	DC bus undervoltage	
	AC input undervoltage	
	AC input overcurrent	
	Input voltage fault	
	DSP and PFC communication failure	
	Temperature sensor malfunction	
	Communication failure between DSP and network adapter	
Abnormal communication with motherboard		
Shut down due to IPM module overheating		
Faulty compressor model		

14. WIRING DIAGRAM

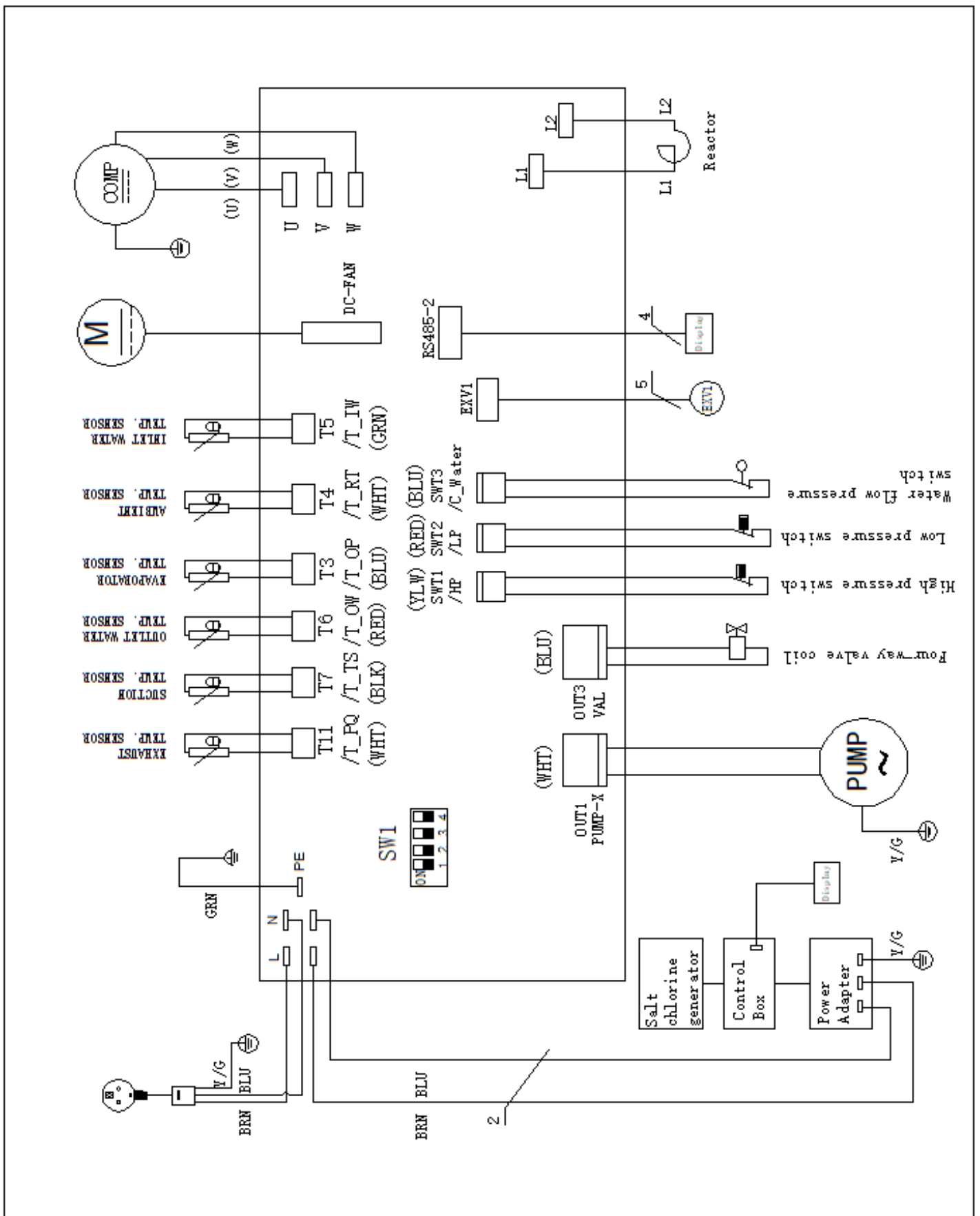

15. WARRANTY

Poolstar SAS warrants to the original owner that the goods shall remain free of manufacturing and material defects for a period of two (2) years.

The compressor is guaranteed for a period of five (5) years.

The titanium tube heat exchanger is guaranteed for a period of fifteen (15) years against chemical corrosion, except in the case of damage due to freezing.

The other components of the condenser are under warranty for a period of two (2) years.

The warranty enters into force on the first billing date.

This warranty does not apply to the following situations:

- Faults or damage arising from installation, operation, or repairs which do not comply with the safety instructions.
- Faults or damage arising from an improper chemical environment in the pool.
- Faults or damage arising from unintended use of the device.
- Damage arising from negligence, accidents, or force majeure.
- Faults or damages arising from the use of unauthorised accessories.

Repairs undertaken during the warranty period must be approved before being carried out by a qualified technician. This warranty is void in the event of repairs to the device made by individuals which have not been authorised by Poolstar.

The parts under warranty shall be replaced or repaired at the discretion of Poolstar. Faulty parts must be returned to us during the warranty period in order to be covered. The warranty does not cover unauthorised replacements or labour costs. Delivery costs for returning the faulty part are not covered by the warranty.

With respect to the chlorinator

This warranty does not apply to the following situations:

- Faults or damage arising from installation, operation, or repairs which do not comply with the safety instructions.
- Faults or damage arising from improper use of the chlorinator, pursuant to the manufacturer's recommendations set out in this User Guide.
- Faults or damage arising from an improper chemical environment in the pool.
- Faults arising from failure to maintain the chemical properties of the pool at the appropriate levels, pursuant to the manufacturer's recommendations set out in this User Guide.
- Faults or damage arising from sabotage, accidents, electrical surges, abuse, negligence, unauthorised or unqualified repairs, alterations to the product, or damage due to fire, floods or frost, acts of God or force majeure.
- Faults or damage arising from unintended use of the device.
- Damage arising from negligence, accidents, or force majeure.
- Faults or damages arising from the use of unauthorised accessories.
- Damage or deterioration of concrete, natural stone, wood or synthetic surfaces in proximity to the pool.

Legal disclaimer: this limited warranty constitutes the entire warranty.

No other guarantees apply, explicit or implicit. This limited warranty grants specific legal rights which may vary by jurisdiction. Under no circumstances shall we be liable for consequential damage(s), special or indirect, regardless of nature, including but not limited to physical injury, property damage, or damage or loss of equipment. The agent / installer shall not be liable for any costs arising from installation or maintenance.

Repairs undertaken during the warranty period must be approved before being carried out by a certified technician. This warranty is void in the event of repairs to the device made by individuals which have not been authorised by Poolstar.

The parts under warranty shall be replaced or repaired at the discretion of Poolstar. Faulty parts must be returned to us during the warranty period in order to be covered. The warranty does not cover unauthorised replacements or labour costs. Delivery costs for returning the faulty part are not covered by the warranty.

Consumables (Filter, cells, joints, strainer, bearings, check valves) are guaranteed for a period of 6 months.

Dear customer,

Please take a few minutes to fill out the warranty card on our website:

<https://assistance.poolstar.fr/>

Thank you for your trust and support.

Happy bathing!

Your personal information is processed in accordance with the French Data Protection Act of 06 January 1978 and will not be shared with 3rd parties.

