



HIGH POWER VALVE TRAIN COMPONENTS



20²⁰
PRODUCT CATALOG
www.FERREA.com

A TIMELINE TO

Valve Line Expansion

Using proprietary manufacturing processes and advanced designs, the Ferrea valve product line expanded and allowed Ferrea to offer additional and applications for the aftermarket consumer.



1970

The dawn of what has become an industry leading brand and product lineup in the valve train components market begins.

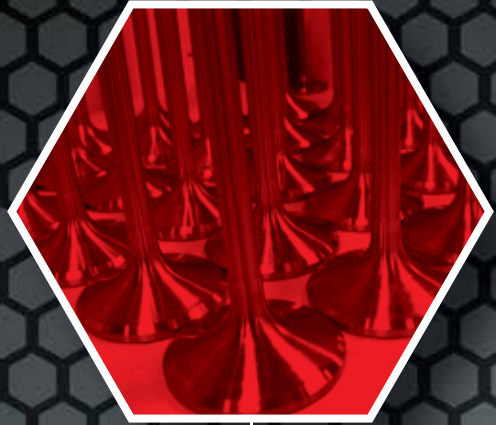

IT ALL STARTS WITH AN IDEA...

Creating the Perfect Valve

As engine builders, our experience, research and development in the racing industry helped become an industry standard product in the market. Through precision crafting and meticulous attention to details evolved the Ferrea valve product lineup.



INNOVATION

Get it Custom Made

Boasting over 40,000 Sq. ft. of manufacturing space in the U.S.A. gave us the ability to dedicate a department to handling the orders of custom valves made each to the customer's specifications.

2020...
To the next
50 Years of
Innovation!

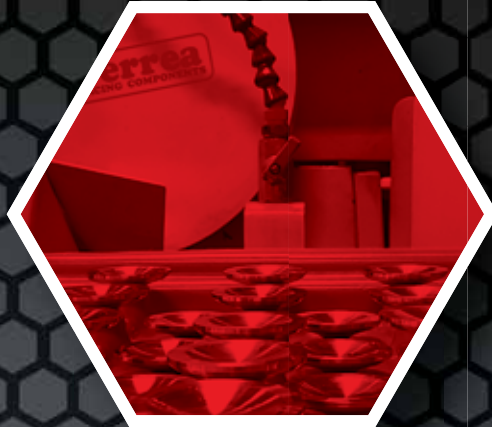

World Domination

Building a vast network of dealers worldwide in over 30 countries.



The Components

To compliment the valve product line, Ferrea began to manufacture a whole package of valve train components that would help run engines at their highest level of performance.

TABLE OF CONTENTS

→→→→→	Welcome to Ferrea	Page 3
→→→→→	Valve Tech	Pages 6-9
	Materials	Page 6
	Super FLO vs FLO	Page 6
	Valve Length Calculations	Page 7
	Production	Page 8
	General Guideline for Ferrea Valves Applications	Page 9
→→→→→	Production and Custom Special Parts	Pages 10-11
	Custom Special Parts	Page 10
	Sodium Fill – Hollow stem Valves	Page 10
	Titanium and Tool Steel Retainers	Page 11
→→→→→	Product Information	Pages 12-32
→→→→→	Domestic and Sport Compact Applications	Pages 12-32
	Valves – Titanium Competition	Page 12
	Valves – Blanks Titanium Competition	Page 13
	Valves – Super Alloy	Page 14
	Valves – Blanks Super Alloy	Page 15
	Valves – Competition Plus Hollow Stem	Pages 16-17
	Valves – Competition Plus	Page 18
	Valves – Blanks Competition Plus	Page 19
	Valves – 6000 Series Competition	Pages 20-21
	Valves – 5000 Series Hi Performance	Pages 22-23
	Springs – Beehive Valve Springs	Page 24
	Springs – Valve Springs	Page 25
	Retainers – Titanium	Page 26
	Retainers – Lightweight Tool Steel	Page 26
	Retainers – Steel	Page 27
	Seat Locators – Spring Seat Locators	Page 28
	Lash Caps	Page 29
	Locks – Titanium Valve Locks	Page 30
	Locks – Steel Valve Locks	Page 30
	Guides – Copper Bronze Valve Guides	Page 32
	Seals – Valve Seals	Page 32
	Valve Spring Kits	Page 33
→→→→→	Domestic Applications Only	Pages 31
	Locks – Steel Valve Super Locks	Page 31
→→→→→	Sport Compact Applications Only	Pages 34-35
	Roller Rocker System	Pages 34-35
→→→→→	Motorcycle Applications Only	Pages 36-43
	Valves – Titanium Competition	Page 36
	Valves – Hollow Stem	Page 37
	Valves – Competition	Pages 38-39
	Springs – Beehive Springs	Page 40
	Springs – Valve Springs	Page 41
	Retainers – Titanium Retainers	Page 42
	Retainers – Lightweight Tool Steel Retainers	Page 42
	Locks – Steel Valve Locks	Page 43
	Guides – Copper Bronze Valve Guides	Page 43
	Seals – Valve Seals	Page 43
→→→→→	Social Media	Page 44
→→→→→	Terms and Conditions	Page 147



APPLI CATION GUIDE

Domestic Applications

Valves – Titanium Competition
Valves – Blanks Titanium Competition
Valves – Super Alloy
Valves – Blanks Super Alloy
Valves – Competition Plus Hollow Stem
Valves – Competition Plus
Valves – Blanks Competition Plus
Valves – 6000 Series Competition
Valves – 5000 Series Hi Performance
Springs – Beehive Valve Springs
Springs – Valve Springs
Retainers – Titanium
Retainers – Tool Steel
Retainers – Steel
Locks – Titanium Valve Locks
Locks – Steel Valve Locks
Locks – Steel Valve Super Locks
Seat Locators – Spring Seat Locators
Lash Caps
Guides – Copper Bronze Valve Guides
Seals – Valve Seals

Pages 45-74

Pages 46-48
Pages 48-49
Pages 50-51
Page 51
Pages 51-52
Pages 53-58
Pages 58-60
Pages 60-63
Pages 64-65
Pages 65-66
Pages 67-69
Pages 69-70
Page 70
Pages 70-71
Page 71
Page 71
Page 72
Page 72
Page 73
Page 73
Page 74

Sport Compact Applications

Valves – Super Alloy
Valves – Blanks Super Alloy
Valves – Competition Plus
Valves – Blanks Competition Plus
Valves – 6000 Series Competition
Valves – 5000 Series Hi Performance
Roller Rocker System
Springs – Beehive Valve Springs
Springs – Valve Springs
Retainers – Titanium
Retainers – Tool Steel
Locks – Steel Valve Locks
Seat Locators – Spring Seat Locators
Lash Caps
Lifter Shims
Guides – Copper Bronze Valve Guides
Seals – Valve Seals

Pages 75-112

Pages 76-78
Page 78
Pages 78-84
Pages 84-85
Pages 86-88
Pages 88-89
Page 89
Page 90
Pages 91-99
Pages 100-105
Page 105
Pages 106-107
Pages 107-110
Page 110
Page 111
Pages 111-112
Page 112

Motorcycle Applications

Valves – Titanium Competition
Valves – Hollow Stem
Valves – Competition
Valves – Blanks Competition
Springs – Beehive Valve Springs
Springs – Valve Springs
Retainers – Titanium Retainers
Retainers – Tool Steel Retainers
Locks – Steel Valve Locks
Seat Locators – Spring Seat Locators
Guides – Copper Bronze Valve Guides
Seals – Valve Seals

Pages 113-126

Page 114
Page 114
Pages 115-121
Pages 121-122
Page 122
Pages 122-124
Pages 125
Page 126
Page 126
Page 126
Page 127
Page 127

Valve Listing by Cylinder Head Manufacturer

Pages 127-138

VALVE TECH

MATERIALS

Proper material choice for the application is crucial to the valve performance and reliability. The extreme change of temperature to a valve in the combustion chamber area (in excess of 1600°F) and in the intake manifold area (up to -25°F), can cause "thermal fatigue". The material's ability to resist these drastic thermal variations is crucial to the valve life. This is why Ferrea is constantly testing and evaluating new materials and processes to provide the highest level of "fatigue resistance" in the industry. Here is the growing list of materials that we use in the production of our valves:

X3	Steel Alloy (Chromium/Silicon)	Intake Valves
Y6	Steel Alloy (Chromium/Silicon)	Heavy Duty Intake Valves
EV8	Stainless Steel (Chromium/Nickel)	Racing Intake & Exhaust Valves
EV8-Z18	Stainless Steel (Chromium/Nickel) + Tungsten	Racing Intake & Exhaust Valves
EV4-N12	Stainless Steel Hi-Temp	Turbo Intake & Exhaust Valves
VV54/EV16	Stainless Steel Hi-Temp	Racing Exhaust Valves
VV54/Nb/W	(Nickel Base + Niobium + Tungsten)	Racing Exhaust Valves
VV50	Stainless Steel Hi-Temp	Racing Exhaust Valves
IN-751	Inconel Alloy 1.800 °F	Turbo Intake & Exhaust Valves
NICKELVAC N80A	Super Alloy (Nickel Base) 1.850 °F	Racing Exhaust Valves
NIMONIC 90	Super Alloy (Nickel Base) 2.000 °F	Turbo Exhaust Valves
NICKELVAC 600	Super Alloy (Nickel/Chromium) 2.200 °F	Racing Exhaust Valves
NICKELVAC 800	Super Alloy (Nickel/Chromium) 2.400 °F	Racing Exhaust Valves (Funny Car/Top Fuel)
NIMONIC 263	Super Alloy (Nickel Base) 2600 °F	Turbo & Nitro Exhaust Valves
WASPALLOY	Super Alloy (Nickel Base) 2700 °F	Turbo & Nitro Exhaust Valves
ASTELLOY 75	Super Alloy (Nickel Base)	Turbo Exhaust Valves
PYROMET	Super Alloy (Nickel Base)	Turbo Exhaust Valves
PYROMET 31 V	Super Alloy (Nickel Base)	Turbo & Nitro Exhaust Valves
PYROMET CTX-909	Super Alloy (High Nickel-Low Expansion)	Heavy Duty Turbo Applications
PYROMET A286	Super Alloy (High Nickel)	Turbo Application - Sport Compact
NCF 3015	Super Alloy (Nickel+Chromium+Titanium)	Turbo Racing Exhaust Valves
STELLITE	(Chromium/Tungstem)	Seat & Tips Applications

SUPER FLO VS. FLO

This illustration shows our Super-Flo valves (often referred to as under-cut or Neck-down), that actually reduces the stem diameter in the port area. This increases flow over "straight" stem diameter (Flo valves) considerably without adverse effect on reliability.

To properly establish the amount of reduction in the stem, several factors have to be considered, such as: original stem diameter, valve head thickness and diameter, valve material, engine application, etc. There is also extensive testing conducted to reach the most efficient combination.

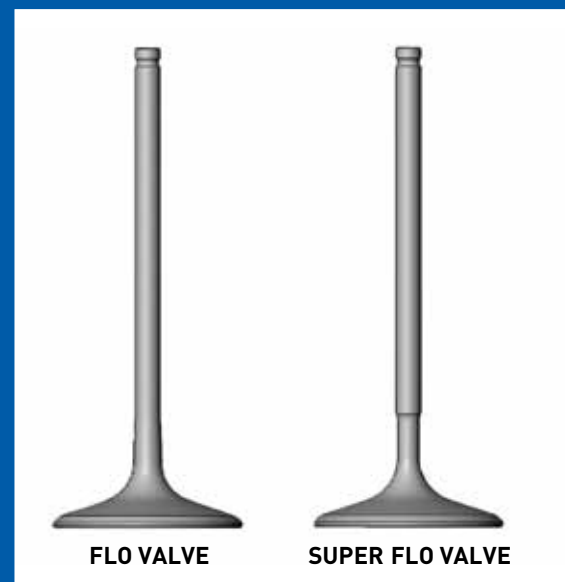

VALVE LENGTH CALCULATIONS

Valve lengths are calculated as overall length measurements. This is the length of the valve from the stem-end tip of the valve to the combustion chamber face. Many of the Cylinder Head Manufacturers use a system that calls for valves to be +100, +250, etc. This is an additional length added to a stock valves for that application. This can sometimes create confusion, since some stock lengths have changed over the years due to slight OEM changes. For the purpose of the Ferrea Racing Components catalog the following will be used as stock lengths for the most popular applications. Understand that as components manufactured for the Racing Industry, many times margins and other measurements will differ from stock, to create better flow characteristics, and to improve durability. As an engine builder or cylinder head assembler, it is your obligation to check this with your setup for that particular cylinder head and assure that proper geometry is obtained.

Many factors such as rocker arm choice and setup, seat machining and valve spring install height may create the need for a valve of different length than specified by either Ferrea Racing Components, or the cylinder head manufacturer.

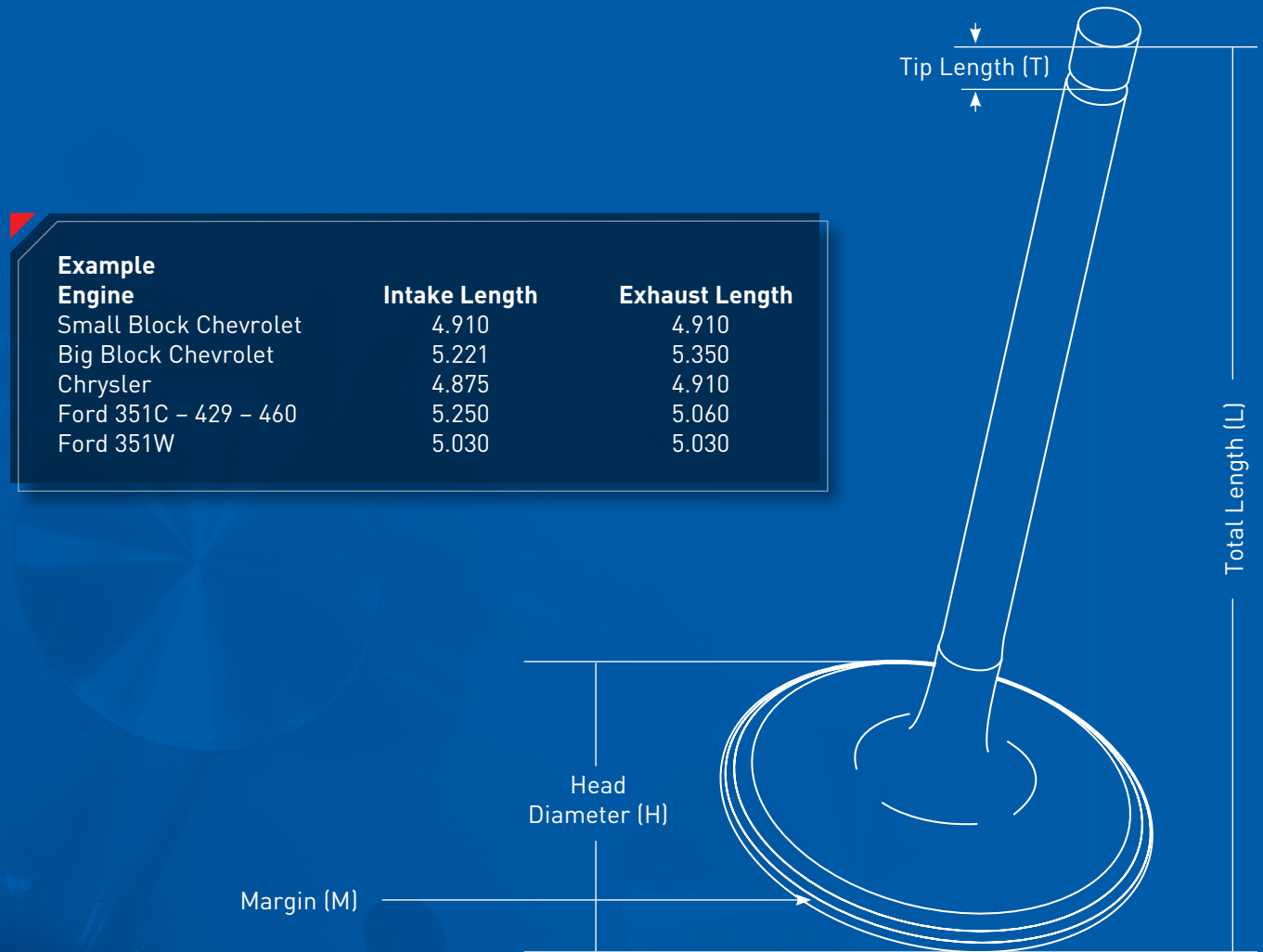

Example Engine	Intake Length	Exhaust Length
Small Block Chevrolet	4.910	4.910
Big Block Chevrolet	5.221	5.350
Chrysler	4.875	4.910
Ford 351C – 429 – 460	5.250	5.060
Ford 351W	5.030	5.030

PRODUCTION

ONE-PIECE-FORGED VALVES

The manufacturing process of our one-piece forged valve begins as a simple steel rod which is formed under a slow two-step electrical upsetting; this ensures proper grain flow at critical temperatures. The formed upset ball is then placed into the die where the forging of the head takes place. The forged piece is then CNC machined entirely to eliminate any imperfections from the forging process.

Next, depending on the properties of the alloys and the specific application (intake or exhaust) the valve will undergo various stages of heat treatments and stress relieving to ensure proper molecular integrity and uniform grain structure throughout the entire piece.

After heat treatment, we use state-of-the-art centerless grinding machines in order to hold strict stem diameter tolerances. We then perform multiple CNC machining operations to the entire valve for consistent quality.

Next, we apply hard chrome plating to the valve stem to reduce guide wear and provide optimum antifriction performance. Finally, depending on which Ferrea Valve Series it is, the valve will either receive a personal touch of micro-mirror polish, swirl polish, or CNC machine finish.

During our final inspection ultrasonic tests and x-rays are performed, piece by piece, in order to give each part a certified quality assurance.

BIMETALLIC FORGED VALVES

Ferrea Bimetallic Valves offer advanced design solutions for extreme valve train applications. Applications that need to meet high heat engine requirements, ultimate tensile strengths, reduced valve stem flex, and induction hardened grooves and valve stem tips, benefit from this type of valve design. This design allows Ferrea Racing components to choose the very best material possible for each individual section of the valve.

The manufacturing process of our bimetallic forged valve utilizes an inertia-welded design. Two steel rods of different valve alloy materials are precisely fused together using state-of-the-art equipment that applies force to weld the two pieces into one component rod. The stem weld point is critical so that its location remains inside the valve guide area at maximum valve lifts.

This method of valve manufacturing is the only approved method for Aerospace valve applications.

Next, the complete steel rod is taken through the same upsetting and forging processes as our one-piece forged valve. Depending on the properties of the alloys and the specific application (intake or exhaust) the valve will undergo various stages of stress relieving to ensure proper molecular integrity throughout the entire piece. After forging and stress relieving, the valves are finished in the same manner as our one piece forged valves.

HARD CHROME PLATE

Ferrea utilizes Hard Chrome Plate on all high performance valves to provide the valve stem with a low coefficient of friction and a hard wear-resistant surface. Hard chrome offers the best choice for extreme engine applications by allowing higher lubricity properties and maximum heat transfer from the valve stem to the valve guide. Hard Chrome Plate is used extensively by racing industry manufacturers worldwide. Ferrea prides itself in providing continuous high quality consistency of hard chrome thicknesses by utilizing the most advance plating systems available. Ferrea offers engine builders the quality they have become accustomed to by continuously improving manufacturing techniques by investing in automated equipment and practicing clean environmental solutions to protect future generations.

VALVE TECH

GENERAL GUIDELINE FOR FERREA VALVES APPLICATION

TITANIUM VALVES:

These valves are used in professionally built high rpm (above 8000) roller or flat tappet racing engines. Applications include Drag Racing, NASCAR, Oval & Sprint Car, Road Racing, and Motorcycle.

SUPER ALLOY:

Ultra Hi-Temperature capable Exhaust Valves for use in Nitro fuel, Nitrous, Supercharged, Turbocharged, Marine, 9.0 to 1 compression and restricted carburetor motors (extreme exhaust temperature present).

HOLLOW STEM VALVES:

These Hollow Stem Lightweight Valves are manufactured with a unique process that gun drill and micro polish the hollow stem cavity. These valves achieve a weight reduction of approximately 20 % in a small block compared with a conventional stainless steel solid-stem valve. This weight savings allow engines to run at higher rpm's than comparable solid valves in classes that do not allow the use of titanium valves. Applications are available for Domestic, Sport Compact and Motorcycle markets.

COMPETITION PLUS:

Our best quality racing valves, engineered for high rpm, high horsepower, racing engines. They have unique features that enhance airflow. This series of valves is manufactured using proprietary heat treatment and stress relieving processes creating valves with unequalled performance and reliability. Applications include Drag Racing, Oval & Sprint Car, Road Racing, Sport Compact, Motorcycle and Marine.

5000 SERIES:

Hi-Performance stainless steel one piece forged valves that are fully CNC machined, have hard chrome treatments and have hard tips. These valves are excellent for Hi-performance Street, mildly modified Drag Racing, and Oval Track applications.

6000 SERIES:

Competition swirl-polished valves with higher fatigue resistance and tensile strengths than our competitors' best offering. These valves are made to withstand high spring pressure, roller and flat tappet cams, Drag Racing, Oval Track, Road Racing and Sport Compact.





CUSTOM

Ferrea Racing Components headquarters is located in Fort Lauderdale, Florida. This facility handles research, development, and production capabilities allowing us to manufacture valves, retainers and other valve train components to fit your particular application. We are constantly updating all of our resources to be able to rapidly respond to our customer demands. Racing Valves not in stock can be custom made for you within days.

CUSTOM VALVE PROGRAM

- Fast turnaround times
- Titanium valves
- High & Low volume production capabilities
- Stainless Steel valves
- Unique designs
- Private label programs

Pricing and lead time are available upon request from our Technical Department at 1-888-733-2505 or at ferrea@ferrea.com.

TITANIUM & TOOL STEEL RETAINERS

Ferrea's Titanium and Tool Steel custom retainer program has grown exponentially in the past 10 years. We have expanded this program with newer updated automated precision CNC machines. These CNC machines give us the ability to custom manufacture lower quantities and competitive pricing for special programs in the performance and racing industry. Our engineering staff places specific designs and testing with each program to ensure the absolute best quality and reliability that comes with the Ferrea brand. The custom retainer program gives you the following advantage.

CUSTOM RETAINER PROGRAM

- Software design
- Mechanical design
- Comprehensive product testing
- High & Low volume production capabilities
- Precision CNC machining
- Fiber laser-marking and identification system
- Strategic contract manufacturing
- Fast turnaround times
- Made & designed in the USA

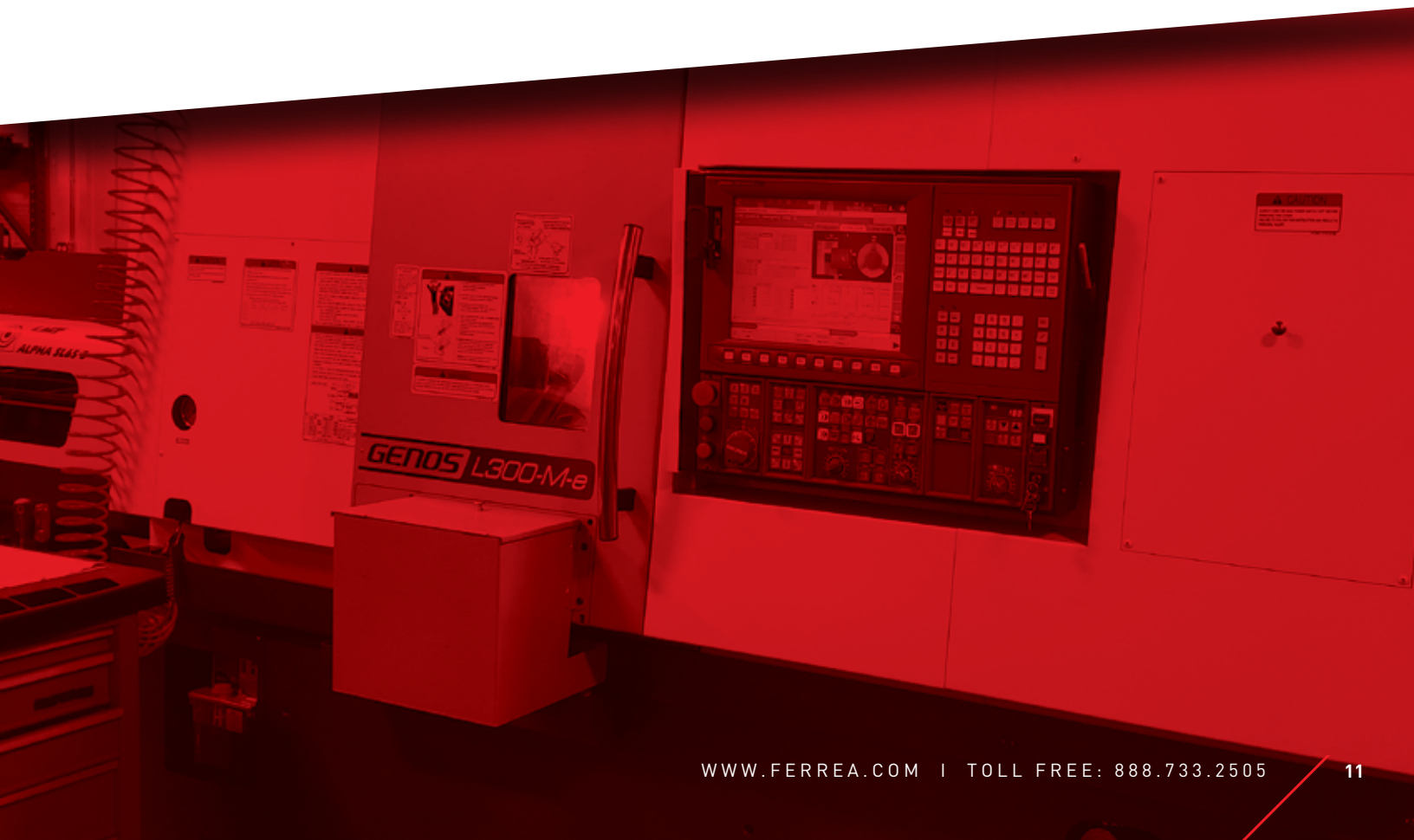

TITANIUM COMPETITION VALVES

Available for both Domestic and Sport Compact applications

TITANIUM

TITANIUM COMPETITION VALVES

Ferrea offers the finest titanium valve on the market. Our extensive R & D facility is constantly implementing new designs and processes, which continue to keep us in the forefront of engine valve technology. We manufacture each valve by forging a special high temperature titanium alloy with silicon. This high-temp alloy is considered a "special upgrade" by our competitors; however, it has been the standard material in all of our exhaust and some intake valves for years. The valves then undergo an extensive heat treatment and stress-relieving process to ensure molecular integrity and prolong the valve's life. Each Ferrea titanium valve is meticulously machined in our own precision CNC machining centers where it must pass extensive quality control procedures.

Our proprietary Chrome Nitride (CrN) coating sets the standard for valve manufacturers around the world. Our unique CrN coating is applied uniformly to the entire valve, forming a protective insulating barrier from high engine temperatures. Ferrea's CrN coating provides rapid heat dissipation to the valve guide surface, friction reduction, wear resistance, hardness, and allows dynamic valve train forces and valve flex stresses without delaminating or flaking. All of our special processes provide maximum performance and reliability, affording longer life in today's professional racing engines.

Additional wear resistant coatings such as CrN or H-DLC can be applied to valve seat and/or tip areas at an extra charge. Please contact a Ferrea sales representative for pricing.

TITANIUM COMPETITION VALVES

BLANKS (BLANKS CUSTOM MACHINED)



TITANIUM COMPETITION VALVES - BLANKS (Blanks Custom Machined)

Ferrea also offers Titanium Blanks Valves that can be custom-machined to your specifications. These custom valves can be produced with or without hard tips. We assure a fast turnaround time. Our selection of blanks now includes the New Special Hi-Temp, Nitrous compatible exhaust valves, unlike all other titanium valves, they will not flake, chip or peel at the bottom of the stem, due to heat or excessive movement. Stem diameters are available in 5mm – 8mm for use in Honda, Acura, Toyota, Nissan, and Aurora IRL motors.

SUPER ALLOY VALVES

Available for both Domestic and Sport Compact applications

SUPER ALLOY VALVES

Ferrea super alloy valves represent the highest level of sophistication in valve technology. These valves are designed to handle the extreme heat requirements and punishment of today's Nitro Fuels, Supercharged, Turbocharged, Nitrous Oxide, and Marine race motors. Many Top Fuel and Funny Car teams can confirm the performance and reliability of these valves which are now available for many engine combinations including Drag Race, Time Attack, Road Race, Endurance and Marine applications.

We have expanded our selection of stem diameters from 5mm to 3/8 stem size for every specific engine combination. This allows us to improve our valve program in the Sport Compact market. Our manufacturing of small engine valves has led our involvement with race teams competing globally in World Rally Challenge, Drag Racing, Drifting and Road Racing.

SUPER ALLOY VALVES

BLANKS

SUPER ALLOY VALVES - BLANKS

Ferrea offers Super Alloy Blank Valves that can be custom-machined to your specifications. These custom valves can be produced with or without hardened tips. All of these valves come with hard-chromed stems. We assure a fast turnaround time and a high level of quality control and precision. Our selection of blanks now include stem diameters from 5mm – 3/8 inch. These blanks have lengths available up to 7.5 inches long, so we can make a short run of valves for most applications.



FERREA

COMPETITION PLUS HOLLOW STEM VALVES

Available for both Domestic and Sport Compact applications

One important factor to take into consideration to increase the engine's rpm's, is the valve train weight. Of course, being the valve a main component, the design has to be perfected to accomplish the weight reduction to allow higher rpm's.

Ferrea's latest contribution in this area is our Lightweight Hollow Stem Valves. We developed a proprietary manufacturing process that gun drills and micro polishes the bore of a valve stem. This proprietary process insures greater structural integrity than any hollow valve on the market today. This achieves a valve reduction in weight of approximately 20 percent compared to a conventional stainless steel solid stem valve. The valves also feature friction welded tips, radial grooves, avionics chrome plated stems, seat hardness up to 42HRc and Super Flo designs to improve flow.



AVIONICS

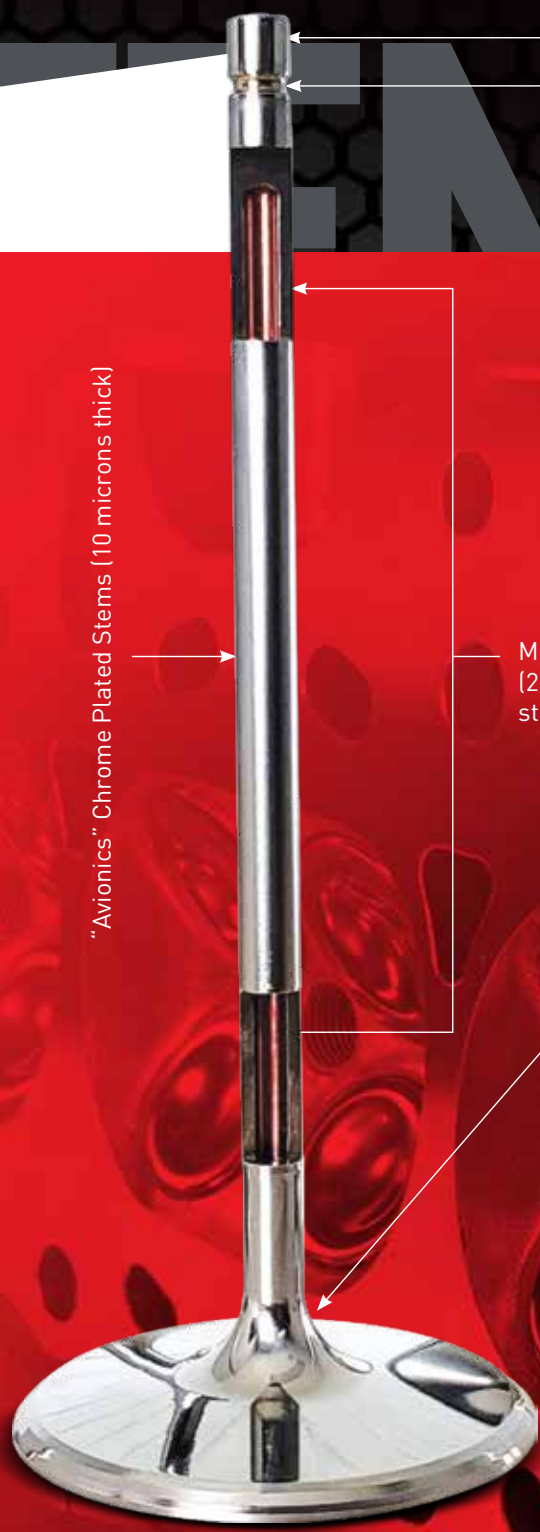

Friction Welded Hard Tips

Radial Groove
(Shot Peened & Rolled)

"Avionics" Chrome Plated Stems (10 microns thick)

Micro Polishes & Gun Drilled Stems
(20% lighter than conventional
stainless alloy valves)

Superflow (undercut) Stems
(Improved flow design)

42 Rc Seat Hardness
(Long life - resists fatigue fractures)

COMPETITION PLUS VALVES

Available for both Domestic and Sport Compact applications

COMPETITION PLUS VALVES

Ferrea Racing Component's Competition Plus Valves have built a reputation as the industry's most reliable racing valve. We, at Ferrea, are dedicated to providing the absolute best product on the market.

Our extensive R & D programs provide technological enhancements that are implemented in each of our competition plus valves. They are engineered for high rpm's, high horsepower racing engines, and are chosen by many top Drag, Oval Track, Road Racing and Sprint Car teams.

To manufacture the valves we use special aerospace quality alloys, including the EV8-Z18, which provides high tensile strength. An exclusive two-step slow forging process ensures proper grain flow and virtually eliminates any damage to the material structure. The valves are then heat-treated and stress-relieved over a 48-hour period, which is the crucial base of our molecular integrity. These valves feature avionics-quality hard chrome along with a specially applied hard tip. Our engineering staff at Ferrea spends countless hours conducting flow bench tests to achieve an optimum balance of flow, velocity and efficiency in the design of these valves. As a result, these valves incorporate smoother radiuses and unique undercuts. These exclusive features are what make the Ferrea Competition Plus Valves unequalled in performance and reliability!

The evolution in volumetric efficiency of today's competition engines has increased the average engine EGT. These higher Exhaust Gas Temperatures decrease the longevity of the valves as well as creating higher levels of metallurgical fatigue. These increased stress loads create an environment in the engine conducive to valve failure.

The exhaust valves in the Competition Plus series are manufactured from Ultra High Strength, High Temp Nickel Stainless Steel Alloys. Ferrea first used this material with great success during the development of a very high stress, high temp endurance racing program.

Listed below are some qualities of the Competition Plus Exhaust Valve material:

- **Tensile strength increased by 20% at high temperature**
- **Fatigue resistance increased by 20%**
- **Valve seat life increased by 25%**

COMPETITION PLUS VALVES

BLANKS

COMPETITION PLUS VALVES - BLANKS

Ferrea also offers Competition Plus Blanks Valves that can be custom-machined to your specifications. Racing Valves not in stock can be custom made for your application within days. Check with us for pricing and lead time.



6000 SERIES COMPETITION VALVES

Available for both Domestic and Sport Compact applications

The 6000 Series Competition Valves are designed to provide excellent reliability in an environment of high spring pressures and roller cams, at a budget price. They have higher fatigue resistance and tensile strengths than our competitor's best offerings. These valves can be used in Drag and Oval Track racing applications.

To manufacture the valves we use our exclusive two-step slow forging process using EV8 stainless steel on both intake and exhaust valves. We provide a special heat-treatment and stress relieving process, along with hard chrome stems and friction-welded hard tips. We finish with a swirl polished head. The valves feature flow improvements to deliver the power needed for today's sophisticated racing engines.

These valves are available for both the traditional Domestic performance and racing engine market and the Sport Compact performance and racing market.



6000 SERIES



5000 SERIES HI PERFORMANCE VALVES

Available for both Domestic and Sport Compact applications

The 5000 Series Valves have become the alternative for performance engine builders that use our competitors "street" or "performance valve". These valves are machined in our CNC centers allowing tight tolerances and cost effective design. They feature a one-piece forging made from stainless steel, a special heat treatment process, hard chrome stems, and hard tip. Most applications are available in an undercut stem and dished head, while other applications are available in straight stem and flat head. These valves provide our customers with maximum value for their dollar, and are designed for Street Performance engines, mildly modified Drag and Oval Track applications.

These valves are available for both the traditional Domestic performance and racing engine market and the Sport Compact performance and racing market.

Many of the 5000 series valves feature flat combustion chamber faces to help increase compression in naturally aspirated engines.

FEATURES:

- ONE-PIECE FORGING STAINLESS STEEL
- PROPRIETARY HEAT TREATMENT PROCESS
- SOME VALVES FEATURE FLAT FACE HIGH COMPRESSION APPLICATIONS
- HARD CHROME STEMS
- FULLY CNC MACHINED

5000 SERIES



RIE

BEEHIVE SPRINGS

Available for both Domestic and Sport Compact applications

BEEHIVE SPRINGS

Ferrea's PAC Alloy Beehive Valve Spring series are available for domestic performance street/strip and racing applications. These single Beehive form valve springs are designed and optimized to reduce valvetrain harmonics, provide greater spring stability, and reduce spring and retainer masses for increase performance and durability in today's harsh racing engines.

PAC Alloy Beehive Valve Springs are developed from premium grade super-clean PAC Alloy material designed for racing applications. These valve springs are crafted using the latest technology in manufacturing and processing techniques through the use of state-of-the-art equipment unmatched throughout the industry. Our springs are progressively coiled with tighter tolerances, heat treated, stress relieved, and multistage shot peened for extended life and durability. Strict quality control procedures and cycle testing ensures consistency from batch-to-batch.

We have expanded our valve spring line offering PAC Alloy Beehive Ovate (Oval/Multi-Radius) wire shape designed to withstand aggressive endurance requirements. Key advantages in using an ovate wire shape are better heat dissipation for longer life, and valvetrain stresses are more effectively distributed over the entire wire shape extending spring life and enabling more horsepower. They have the highest level of fatigue resistance available, while minimizing load loss for today's aggressive valvetrain combinations.

PAC Racing develops beehive springs with aid of RPD (Rapid Prototype Development) technique to ensure that the engine runs as expected. Numerous spring designs are evaluated and tested before the final spring shape is determined.



FEA diagram illustrates the benefits of Beehive Ovate wire over standard round wire spring. This wire more efficiently distributes the stress over the entire wire shape.

FEA of round spring wire spring. High stress on ID

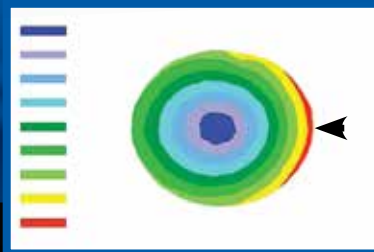

FEA of ovate wire spring. High stress is on flanks of wire

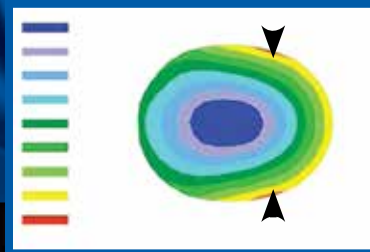

VALVE SPRINGS

Available for both Domestic and Sport Compact applications

VALVE SPRINGS

Harmonics or high frequency fatigue is present in all racing engines and will usually destroy the valvetrain if not controlled. Properly designed valve springs will control the dominant harmonics, provide the needed stability, and reduce valvetrain component wear.

Ferrea Valve Springs are developed from high strength alloys, including premium grade chrome silicon steel. These springs are manufactured with state-of-the-art equipment. Our springs are heat-treated and stress relieved, which dramatically increases the spring's life. Strict quality control procedures and cycle testing ensures consistency from batch to batch. Ferrea Valve Springs provide the stability needed for high lift, high rpm racing engines, while minimizing the load loss for today's aggressive valvetrain combinations.

We expanded our Springs offering to include many new designs and applications. Our goal is to provide the best possible valve-train combinations for all racing environments from circle track, drag racing, motorcycle racing and offshore marine racing.



RETAINERS

Available for both Domestic and Sport Compact applications

TITANIUM RETAINERS

Ferrea is pleased to offer our Pro-Series Titanium Retainers including sizes that fit both traditional Domestic springs and Sport Compact springs. Precision CNC-machined from aerospace quality titanium, these Pro Retainers are fully heat-treated and finished to exact tolerances, adding strength while offering a 40% weight reduction over conventional steel retainers. We have available applications for 6, 7, 8 (super 7) and 10 degrees. Examine the overall quality of Ferrea's Pro-Series Retainers and see why professional engine builders demand Ferrea Racing Components.

Ferrea extensive R&D design with Titanium Retainers, using Finite Elements Analysis

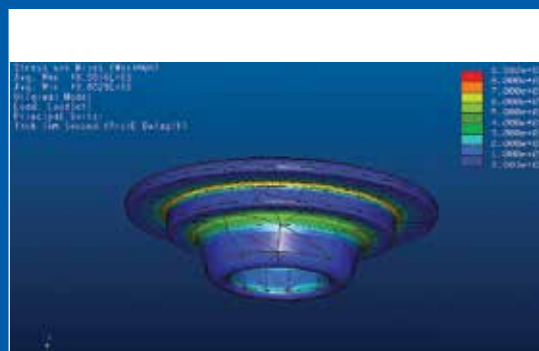

LIGHTWEIGHT TOOL STEEL RETAINERS

Ferrea's high quality Tool Steel Retainers are available for Domestic and Sport Compact applications. We developed these Tool Steel Retainers using latest FEA and CAD software plus running compressive load rigs to prove material strengths. Tool Steel Retainers provide many valvetrain benefits: light weight, exceptional wear and strength properties, making them able to withstand even the most demanding race applications. CNC machined for high quality precision and tight tolerances. These retainers are only slightly heavier than titanium retainers (depending upon application).

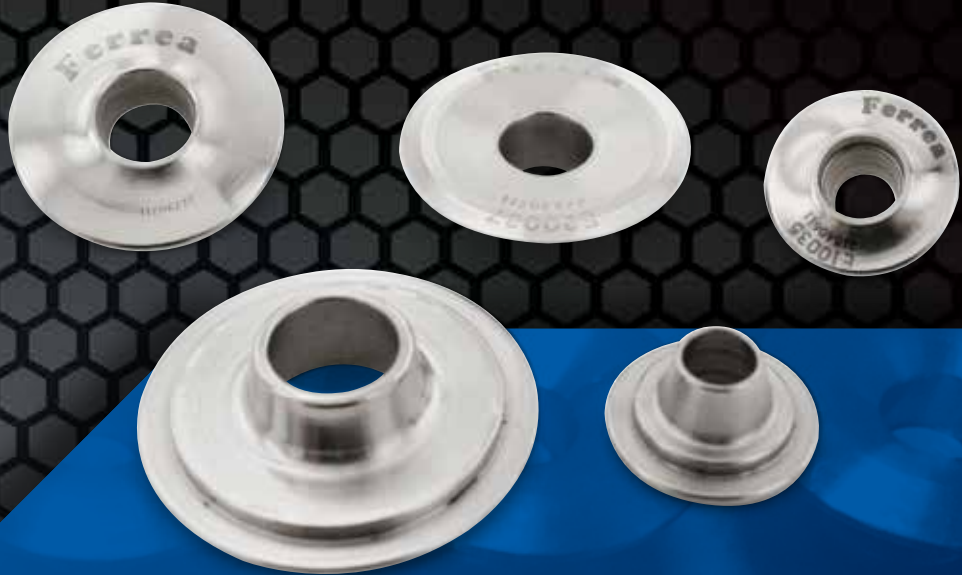

STEEL RETAINERS

Ferrea offers precision CNC machined Steel Retainers from 4140 chromemoly for superior strength and stability with new valve spring pressures. Our Steel Retainers are heat treated and finished in black oxide to provide exceptional wear characteristics in extreme racing applications. These high quality retainers are designed for positive location when used with Ferrea high quality valve springs. CNC machined for precision fitment and tight tolerances.

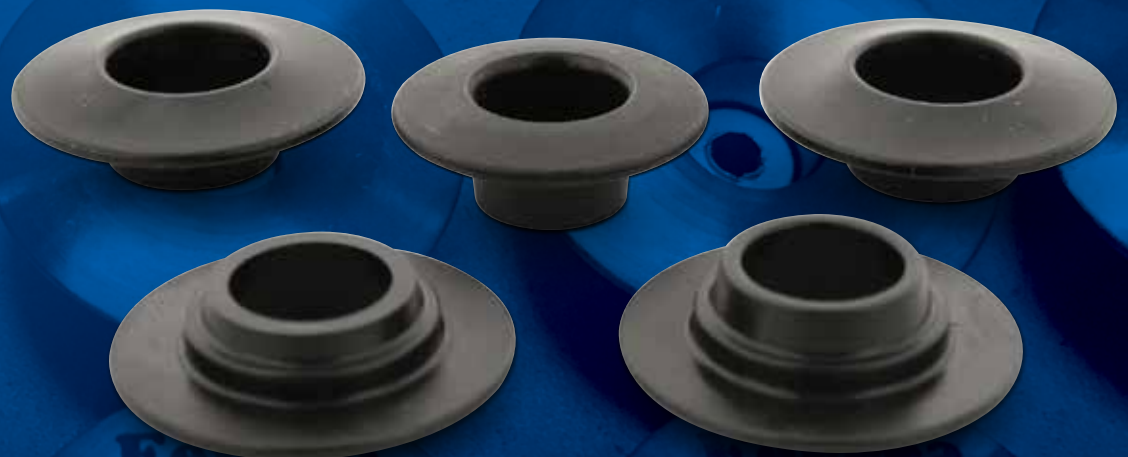

SPRING SEAT LOCATORS

Available for both Domestic and Sport Compact applications

To complete the Valve-Train Spring Kit Ferrea offers premium quality Spring Seat Locators. Ferrea takes great pride in fully CNC machining in-house from 4140 chromoly alloy for different applications. Each piece is crafted to exact tolerances OD & ID specs and insure flat, parallel spring pad to the bottom surface. Heat treatment consists of a hard Nitrided surface for unmatched toughness and anti-wear characteristics. We also offer custom manufactured production runs capable of meeting your specifications.



SPR

WA

LASH CAPS

Available for both Domestic and Sport Compact applications



Our Ferrea Lash Caps are machined from 4140 chromoly alloy. Each piece is specially heat treated for maximum strength and finished with black oxide for an attractive finish. These parts are available for most applications in various sizes from 5.5mm to 3/8".

LASH CAPS

VALVE LOCKS

Available for both Domestic and Sport Compact applications

TITANIUM VALVE LOCKS

Our newly designed Radial Valve Locks and Square Valve Locks, are made of premium Titanium alloy. The CNC-machined finish and the strict tolerances ensure a precise “lock” on the valve assembly. We offer them in the most popular applications.



STEEL VALVE LOCKS

Ferrea Valve Locks are manufactured from high quality 4140 chromoly bar stock and machined to exact tolerances. The locks are heat-treated for maximum strength and finished with the black oxide for an attractive appearance. Our locks are available for Super 7°, 6°, 7° and 10° applications.

SHOULDER VALVE LOCK DESIGN

Our newly designed radial valve locks feature a shoulder which provides extra material for support and protection for those high ratio rocker arm applications. The shoulder provides the stability needed at high RPMs reducing valve tip flex and fatigue.

Note: Shoulder locks can only be used on valves with a tip length of .250” or greater.

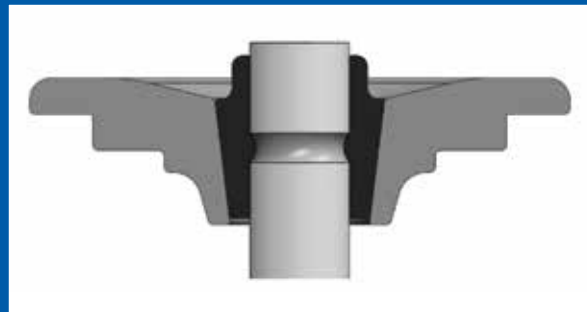

Available for both Domestic and Sport Compact applications

STEEL VALVE SUPER LOCKS

The Ferrea Super Locks were designed and developed as a solution for the Top Fuel & Funny Car engine builders experiencing problems of premature wear in the lock and tip area of the valve. This premature wear is attributed mainly to poor geometry of the HEMI motor, and the super high spring pressures present. Our lock assembly replaces the need for hard tips, by incorporating a special lash cap which is surrounded by a shouldered valve lock which "locks" the valve stem above and below the keeper groove and secures the lash cap to prevent any unwanted movement. This innovative lock design is the choice of many Drag Racing and Sprint Cup engine builders. The Ferrea Superlock mates ideally with steel and titanium valves, and is available in Super 7 and 10 degree in standard and $+.050$ installed heights.

Specially designed "Lash Cap" with a Step Locking Mechanism.

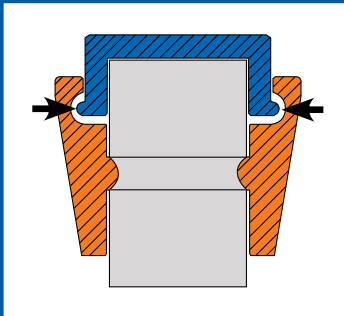

LOCKS

COPPER BRONZE VALVE GUIDES / VALVE SEALS

Available for both Domestic and Sport Compact applications

COPPER BRONZE VALVE GUIDES

Ferrea's high quality copper-bronze blended alloy valve guides are developed with proprietary heat treatment processes, allowing for greater heat dissipation, heat resistance, and lubricity properties for the next generation of high performance race engines.

All our valves guides are CNC precision machined to exact tolerances. They are ideal for intake and exhaust applications and are compatible with titanium and stainless steel valves.



VALVE SEALS

Ferrea valve seals are made of rubber compound material for intake application and special hi-temp compound for exhaust application.

VALVE SPRING KITS

Available for both Domestic and Sport Compact applications

VALVE SPRING KITS

Ferrea Valve Spring Kits bring together some of our best valvetrain components to help maximize performance specific to your engine application. Our knowledge and expertise have allowed us to build valve spring kits using components of premium quality and durability that exceed standard industry requirements.



KIT COMPONENTS



VALVE SPRINGS

- Ferrea Valve Springs provide the stability needed for high lift, high rpm racing engines, while minimizing the load loss for today's aggressive valvetrain combinations.
- Our springs are heat-treated and stress relieved, which dramatically increases the spring's life.



RETAINERS

- Ferrea retainers are fully heat-treated and finished to exact tolerances, adding strength while offering a weight reduction over conventional steel retainers.
- Precision CNC-machined from aerospace quality titanium materials.



SEAT LOCATORS

- Ferrea seat locators are fully CNC machined in-house from 4140 chromoly steel alloy for different applications.
- Heat treatment consists of a hard Nitrided surface for unmatched toughness and anti-wear characteristics.



VALVE LOCKS

- Ferrea Valve Locks are manufactured from high quality 4140 chromoly bar stock and machined to exact tolerances.
- The locks are heat-treated for maximum strength and finished with the black oxide for an attractive appearance.

ROLLER ROCKER SYSTEMS

Available for Sport Compact applications

ROLLER ROCKER SYSTEM

Ferrea's optimized Special Aluminum-Magnesium Roller Rocker System was designed and developed to replace the factory Steel Rocker Arm System and eliminate the VTEC Function. Factors such as weight, mass moment of inertia, deflection, and cycle durability are taken into account throughout the design and testing process.

Premium Material: We use special high quality 70 Series Aerospace Aluminum-Magnesium Alloy, heat-treated to provide superior strength.

Manufacturing: Fully CNC machined, profiled for weight reduction, (OEM unit weighs 110% more) which improves moment of inertia, and increases the RPM range of Valve-train.

Roller Wheel: The Roller Needle Bearing prevents roller from skidding across the camshaft surface, unlike the (OEM) stock rocker pad, thus reducing friction dramatically.

Tool Steel Pin: The Tool Steel Roller Pin is compressed between the rocker to stabilize the rocker motion throughout the entire RPM range.

Installation: Our Roller Rocker System comes with all hardware and requires no head modifications for installation.

(1) U.S. Patent No. US6, 352, 062 B1.

Acura K20
Roller Rocker

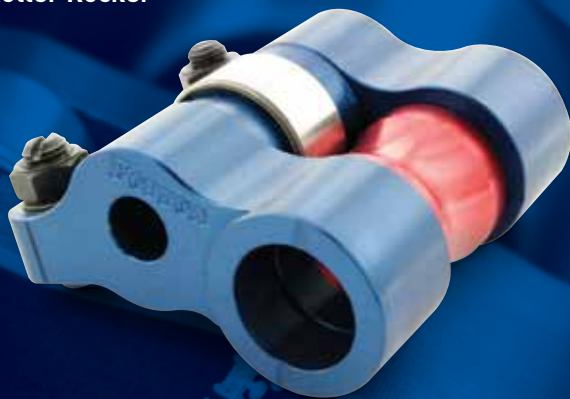

Honda B18/H22
Roller Rocker



Acura K20
Roller Rocker
.600 + High Lift



ROCKERS

Available for Sport Compact applications

ROLLER ROCKER SYSTEM

Ferrea's optimized Special Aluminum-Magnesium Roller Rocker System was designed and developed to replace the factory Steel Rocker Arm System. Factors such as weight, mass moment of inertia, deflection, and cycle durability are taken into account throughout the design and testing process.

Technical Specifications:

- Maximum Net Lift 13.5mm (With Ferrea Valve spring Assembly Aluminum-Magnesium CNC machined stock rocker assembly mass 266 grams).
- Ferrea rocker assembly mass: 138 grams (51% less mass than factory rockers)
- Stock fulcrum mass: 97 grams. Ferrea fulcrum mass: 74 grams
- Can be used with stock or any aftermarket camshafts. Uses center large lobe only, must use reprogrammed ECU or standalone ECU tuning system.
- To work properly and provide lubrication to the rocker arms during operation, the ECU must control the VVTi timing sequence function.



Lotus-Toyota 2ZZ-GE Roller Rocker

ROLLER ROCKER SYSTEM

Ferrea's optimized Special Aluminum-Magnesium Roller Rocker System was designed and developed to replace the factory Steel Rocker Arm System and eliminate the VTEC Function. Factors such as weight, mass moment of inertia, deflection, and cycle durability are taken into account throughout the design and testing process.

Premium Material: We use special high quality 70 Series Aerospace Aluminum-Magnesium Alloy, heat-treated to provide superior strength.

Manufacturing: Fully CNC machined, profiled for weight reduction, (Stock exhaust rocker assembly mass: 270 grams. Stock intake rocker assembly mass: 170 grams) Ferrea rocker assembly mass: 162 grams (40% less mass than factory exhaust rockers) which improves moment of inertia, and increases the RPM range of Valve-train.



Honda Type-R K20C1 Roller Rocker

Roller Wheel: The Roller Needle Bearing are manufactured from high quality materials. Can be used with stock or any aftermarket camshaft.

Tool Steel Pin: The Tool Steel Roller Pin is compressed between the rocker to stabilize the rocker motion throughout the entire RPM range.

Installation: Our Roller Rocker System comes with all hardware and requires no head modifications for installation.

MOTORCYCLE

TITANIUM COMPETITION VALVES

TITANIUM COMPETITION VALVES

We manufacture each valve by forging a special high temperature titanium alloy with silicon. This high-temp alloy is considered a “special upgrade” by our competitors; however, it has been the standard material in all of our exhaust and for years. The valves then undergo an extensive heat treatment and stress-relieving process to ensure molecular integrity and prolong the valve’s life. Each Ferrea titanium valve is meticulously machined in our own precision CNC machining centers. Our proprietary CrN coating is applied forming a protective insulating barrier from high engine temperatures. Ferrea’s CrN coating provides rapid heat dissipation from the valve stem to the valve guide reducing friction and increasing wear resistance. All of our special processes provide maximum performance and reliability, affording longer life in today’s ultra high rpm motorcycle engines.

Additional wear resistant coatings such as CrN or H-DLC can be applied to valve seat and/or tip areas at an extra charge. Please contact a Ferrea sales representative for pricing.



CYCLE

MOTORCYCLE HOLLOW STEM VALVES

HOLLOW STEM VALVES

To the wide selection of valves that Ferrea offer to the motorcycle market, we add the Hollow Stem Lightweight Valve, a unique piece that we manufacture gun drilling and micro polishing the hollow stem.

The use of light components in the valve train allows the increase in rpm's and a generation of more HP (hollow stem valves achieve a weight reduction of about 20% compare with conventional stainless steel solid-stem valve).

These Ferrea valves feature radial grooves, friction welded tips, avionics chrome plated stems, super flo to improve flow design seat hardness up to 42 HRc.



MOTORCYCLE

COMPETITION VALVES

COMPETITION VALVES

For over a decade Ferrea has supplied many top race teams and elite engine builders with the best Competition Motorcycle Valve in the world. Whether it's a 14,000 rpm Pro Stock Motorcycle Titanium Valve or a 1000 hp + Top Fuel Super Alloy Valve, Ferrea has what you need. We have developed the motorcycle-racing valve implementing the same technology as our extreme duty, competition plus (automotive) racing valve. The net result is a valve that can withstand the punishment of extremely high rpm, multiple stages of nitrous injection, turbocharger and even blown fuel applications. No other valve even comes close to the performance and reliability of Ferrea's. Our valves have set more records in numerous categories worldwide than any other valve on the market.

We have added a larger selection of valve blanks for all types of motorcycle applications. We can custom manufacture any valve within 7-10 days.



CYCLE



MOTORCYCLE

BEEHIVE VALVE SPRINGS

BEEHIVE VALVES SPRINGS

Ferrea's PAC Alloy Beehive Valve Spring series are available for Motorcycle applications. These single Beehive form valve springs are designed and optimized to reduce valvetrain harmonics, provide greater spring stability, and reduce spring and retainer masses for increase performance and durability in today's harsh engines environments.

PAC Alloy Beehive Valve Springs are developed from premium grade super-clean PAC Alloy material designed for racing applications. These valve springs are crafted using the latest technology in manufacturing and processing techniques through the use of state-of-the-art equipment unmatched throughout the industry.

Our springs are progressively coiled with tighter tolerances, heat treated, stress relieved, and multistage shot peen for extended life and durability. Strict quality control procedures and cycle testing ensures consistency from batch-to-batch.

We have expanded our valve spring line offering PAC Alloy Beehive Ovate (Oval/Multi-Radius) wire shape designed to withstand aggressive endurance requirements. Key advantages in using an ovate wire shape are better heat dissipation for longer life, and valvetrain stresses are more effectively distributed over the entire wire shape extending spring life and enabling more horsepower. They have the highest level of fatigue resistance available, while minimizing load loss for today's aggressive valvetrain combinations.



VALVE SPRINGS

We expanded our springs offering to include street bike, motocross and race bike applications, providing the best possible valve-train combination for your motorcycle.

Ferrea's motorcycle valve springs are made of premium grade chrome-silicon alloys. They are heat-treated and stress-relieved to increase the spring's life. Strict quality control procedures and cycle testing ensure consistency from batch to batch.



YCLE

MOTORCYCLE

RETAINERS

TITANIUM RETAINERS

Ferrea is pleased to offer our Pro-Series Titanium Retainers for motorcycle applications. Precision CNC-machined from aerospace quality titanium, these Pro Retainers are fully heat-treated and finished to exact tolerances, adding strength while offering a 40% weight reduction over conventional steel retainers. We have available applications for 6, 7, 8 (super 7) and 10 degrees. Examine the overall quality of Ferrea's Pro-Series Retainers and see why professional engine builders demand Ferrea Racing Components.



LIGHTWEIGHT TOOL STEEL RETAINERS

Ferrea's high quality Tool Steel Retainers are available for motorcycle applications. We developed these Tool Steel Retainers using latest FEA and CAD software plus running compressive load rigs to prove material strengths. Tool Steel Retainers provide many valvetrain benefits: light weight, exceptional wear and strength, properties making them able to withstand even the most demanding race applications. CNC machined for high quality precision and tight tolerances. Only slightly heavier than titanium retainers (depending upon application).



VALVE LOCKS / GUIDES / SEALS



STEEL VALVE LOCKS

Ferrea Valve Locks are manufactured from high quality 4140 chromoly bar stock and machined to exact tolerances. The locks are heat-treated for maximum strength and finished with the black oxide for an attractive appearance. Our locks are available for Super 7°, 6°, 7° and 10° applications.

VALVE SEALS

Ferrea valve seals are made of rubber compound material for intake application and special hi-temp compound for exhaust application.



COPPER BRONZE VALVE GUIDES

Ferrea's high quality copper-bronze blended alloy valve guide are developed with proprietary heat treatment processes, allowing for greater heat dissipation, heat resistance, and lubricity properties for the next generation of high performance race engines. All our valves guides are CNC precision machined to exact tolerances. They are ideal for intake and exhaust applications and are compatible with titanium and stainless steel valves.

CONNECT

STAY CONNECTED

Follow us on any of these social media platforms for new product information, special promotions and events.



VISIT OUR NEW WEBSITE AND SUBSCRIBE TO OUR NEWSLETTER AT
FERREA.COM



HIGH POWER VALVETRAIN COMPONENTS

2020 APPLICATION GUIDE

DOMESTIC

DOMESTIC	Pages 45-74
SPORT COMPACT	Pages 75-112
MOTORCYCLE	Pages 113-126
VALVE LISTING (by Manufacturer)	Pages 127-138

TITANIUM COMPETITION VALVES

Part#	Type	Head Diam.	Stem Diam.	Overall Length	Tip Length	References
BRIGGS & STRATTON						
F0082	E	1.141	.247	3.845	.235	15° Super Flo-Go Kart & Jr. Dragster
F0080	I	1.252	.247	3.845	.235	15° Super Flo-Go Kart & Jr. Dragster
F0081	I	1.378	.247	3.845	.235	10° Super Flo-Go Kart & Jr. Dragster
F0083	E/I	1.500	.247	4.800	BLANK	10° Super Flo-Go Kart & Jr. Dragster
CHEVROLET, CHRYSLER, FORD (BIG BLOCK 5/16)						
F1326	E	1.900	5/16	6.450	.290	25° Tulip-Hard Tip optional-PONTIAC
F1760	I	2.375	5/16	5.350	.290	13° Hard Tip optional. BBC +.100
F1761	I	2.375	5/16	5.450	.290	13° Hard Tip optional. Brodix/Dart
F1762	I	2.375	5/16	5.550	.290	13° Hard Tip optional. Brodix/Sonny BB5
F1763	I	2.375	5/16	6.410	.290	13° Hard Tip optional-PONTIAC
F1764	I	2.375	5/16	6.605	.290	13° Hard Tip optional-PONTIAC
F1765	I	2.425	5/16	6.410	.290	13° Hard Tip optional-PONTIAC
F1325	I	2.425	5/16	6.605	.290	12° Hard Tip optional-PONTIAC
F1766	I	2.425	5/16	6.900	.290	13° Hard Tip optional-EPD
F1767	I	2.500	5/16	6.605	.290	13° Hard Tip optional-PONTIAC
F1768	I	2.500	5/16	6.900	.290	13° Hard Tip optional-EPD-Pro Stock
CHEVROLET, CHRYSLER, FORD (BIG BLOCK 11/32)						
F1747	E	1.880	11/32	5.500	.290	31° Hard Tip optional
F1626	E	1.900	11/32	5.350	.290	22° Tulip-Hard Tip optional. Stock
F1327	E	1.900	11/32	5.425	.290	22° Tulip-Hard Tip optional. +.100
F1377	E	1.900	11/32	5.525	.290	22° Tulip-Hard Tip optional. +.200
F1328	E	1.900	11/32	5.700	.290	25° Tulip-Hard Tip optional-SVO-A460
F1627	E	1.900	11/32	6.165	.290	22° Tulip-Hard Tip optional-SVO-C460
F1628	E	1.900	11/32	6.240	.290	22° Tulip-Hard Tip optional-SVO-C460
F1638	E	1.900	11/32	6.370	.290	22° Tulip-Hard Tip optional-FORD-SVO-C460
F1639	E	1.900	11/32	6.450	.290	28° Tulip Hard Tip optional-PONTIAC-Big Chief
F1629	E	1.900	11/32	6.600	.290	22° Tulip-Hard Tip optional-EPD
F1324	E	1.920	11/32	6.450	.290	22° Tulip-Hard Tip optional-PONTIAC
F1631	E	1.920	11/32	6.600	.290	22° Tulip-Hard Tip optional-EPD
F1632	E	1.940	11/32	5.020	.290	22° Tulip-Hard Tip optional-CHRY HEMI
F1633	E	1.940	11/32	5.700	.290	22° Tulip-Hard Tip optional-SVO-A460
F1634	E	1.940	11/32	6.600	.290	22° Tulip-Hard Tip optional-EPD
F1637	E	1.950	11/32	6.040	.250	25° Tulip.Brad Anderson Heads
F1333	E	2.000	11/32	5.020	.250	22° Tulip.CHRY HEMI
F1636	E	2.000	11/32	6.600	.290	25° Tulip-Hard Tip optional-EPD
F1330	I	2.250	11/32	5.350	.290	12° Hard Tip optional. +.100
F1309	I	2.250	11/32	5.450	.290	12° Hard Tip optional. +.200
F1748	I	2.250	11/32	5.540	.290	12° Hard Tip optional
F1680	I	2.250	11/32	5.550	.290	12° Hard Tip optional. +.300
F1681	I	2.300	11/32	5.350	.290	12° Hard Tip optional. +.100
F1331	I	2.300	11/32	5.450	.290	12° Hard Tip optional. +.200
F1684	I	2.300	11/32	5.525	.290	12° Hard Tip optional-Brodix/Sonny BB5
F1749	I	2.300	11/32	5.540	.290	12° Hard Tip optional
F1375	I	2.300	11/32	6.250	.250	22° Tulip-Herbert Special. TAD-F/C
F1682	I	2.325	11/32	5.350	.290	12° Hard Tip optional. +.100
F1683	I	2.325	11/32	5.450	.290	12° Hard Tip optional. +.200
F1367	I	2.325	11/32	5.525	.290	12° Hard Tip optional-Brodix/Sonny BB5
F1694	I	2.350	11/32	5.525	.290	12° Hard Tip optional-Brodix/Sonny BB5
F1329	I	2.375	11/32	5.610	.250	25° Tulip-CHRY HEMI-T/F-F/C
F1685	I	2.375	11/32	6.900	.290	12° Hard Tip optional-EPD
F1729	I	2.400	11/32	5.610	.250	25° Tulip-CHRY HEMI-T/F-F/C
F1334	I	2.400	11/32	5.755	.290	12° Hard Tip optional-SVO-A460
F1692	I	2.425	11/32	6.400	.400	12° Hard Tip optional. Brad Anderson Heads
F1686	I	2.425	11/32	6.410	.290	12° Hard Tip optional-PONTIAC
F1323	I	2.425	11/32	6.605	.290	12° Hard Tip optional-PONTIAC
F1687	I	2.425	11/32	6.900	.290	12° Hard Tip optional-EPD
F1338	I	2.450	11/32	5.475	.260	25° Tulip-CHRYSLER HEMI
F1339	I	2.450	11/32	5.610	.260	25° Semi Tulip-CHRYSLER HEMI
F1688	I	2.450	11/32	6.300	.290	12° Hard Tip optional-SVO-C 460
F1693	I	2.450	11/32	6.470	.290	12° Hard Tip optional. FORD-SVO-C 460
F1689	I	2.450	11/32	6.900	.290	12° Hard Tip optional-EPD
F1690	I	2.500	11/32	6.900	.290	25° Tulip-Hard Tip optional-EPD-Pro Stock
F1691	I	2.600	11/32	6.900	.290	25° Tulip-Hard Tip optional-EPD-Pro Stock
F1391	I	2.600	11/32	6.950	.250	25° Tulip-Herbert-T/F-F/C

DOMESTIC APPLICATIONS

(* Additional wear resistant coatings such as CrN or H-DLC can be applied to valve seat and/or tip areas at an extra charge. Please contact a Ferrea sales representative for pricing.

TITANIUM COMPETITION VALVES

Part#	Type	Head Diam.	Stem Diam.	Overall Length	Tip Length	References
CHEVROLET, CHRYSLER, FORD (SMALL BLOCK 5/16)						
F1730	I	2.100	5/16	5.285	.290	12° Hard Tip optional-Yates Head
F1731	I	2.100	5/16	5.340	.290	12° Hard Tip optional-Brodix/Dart Head. +.400
F1732	I	2.100	5/16	5.450	.290	12° Hard Tip optional-Brodix/Dart Head. +.500
F1733	I	2.100	5/16	5.550	.290	12° Hard Tip optional-Brodix/Dart Head. +.600
F1743	I	2.125	5/16	5.285	.290	12° Hard Tip optional-Yates Head
F1744	I	2.125	5/16	5.340	.290	12° Hard Tip optional-Brodix/Dart Head. +.400
F1745	I	2.125	5/16	5.450	.290	12° Hard Tip optional-Brodix/Dart Head. +.500
F1746	I	2.125	5/16	5.550	.290	12° Hard Tip optional-Brodix/Dart Head. +.600
F1734	I	2.150	5/16	5.285	.290	12° Hard Tip optional-Yates Head
F1735	I	2.150	5/16	5.340	.290	12° Hard Tip optional-Brodix/Dart Head. +.400
F1736	I	2.150	5/16	5.450	.290	12° Hard Tip optional-Brodix/Dart Head. +.500
F1737	I	2.150	5/16	5.550	.290	12° Hard Tip optional-Brodix/Dart Head. +.600
F1738	I	2.200	5/16	5.285	.290	12° Hard Tip optional-Yates Head
F1739	I	2.200	5/16	5.340	.290	12° Hard Tip optional-Brodix/Dart Head. +.400
F1740	I	2.200	5/16	5.450	.290	12° Hard Tip optional-Brodix/Dart Head. +.500
F1741	I	2.200	5/16	5.550	.290	12° Hard Tip optional-Brodix/Dart Head. +.600
F1742	I	2.200	5/16	5.810	.290	12° Hard Tip optional-Splayed Head
CHEVROLET, CHRYSLER, FORD (SMALL BLOCK 11/32)						
F1346	E	1.600	11/32	4.960	.290	15° Hard Tip optional. Stock
F1302	E	1.600	11/32	5.040	.290	15° Hard Tip optional. +.100
F1341	E	1.600	11/32	5.140	.290	15° Hard Tip optional. +.200
F1600	E	1.600	11/32	5.240	.290	15° Hard Tip optional. +.300
F1308	E	1.600	11/32	5.340	.290	15° Hard Tip optional. +.400
F1344	E	1.600	11/32	5.450	.290	15° Hard Tip optional. +.500
F1351	E	1.600	11/32	5.550	.290	25° Tulip-Hard Tip optional. +.600
F1606	E	1.600	11/32	6.090	.290	25° Hard Tip optional-Brodix CVSP
F1347	E	1.625	11/32	4.960	.290	15° Hard Tip optional. Stock
F1303	E	1.625	11/32	5.040	.290	15° Hard Tip optional. +.100
F1340	E	1.625	11/32	5.140	.290	25° Tulip-Hard Tip optional. +.200
F1601	E	1.625	11/32	5.240	.290	15° Hard Tip optional. +.300
F1371	E	1.625	11/32	5.340	.290	15° Hard Tip optional. +.400
F1342	E	1.625	11/32	5.450	.290	15° Hard Tip optional. +.500
F1602	E	1.625	11/32	5.550	.290	15° Hard Tip optional. +.600
F1603	E	1.625	11/32	5.700	.290	15° Hard Tip optional-Splayed Head
F1345	E	1.650	11/32	5.140	.290	15° Hard Tip optional. +.200
F1604	E	1.650	11/32	5.240	.290	22° Semi Tulip-Hard Tip optional. +.300
F1605	E	1.650	11/32	5.340	.290	22° Semi Tulip-Hard Tip optional. +.400
F1343	E	1.650	11/32	5.450	.290	15° Hard Tip optional. +.500
F1348	E	1.650	11/32	5.450	.290	25° Tulip-Hard Tip optional. +.500
F1353	E	1.650	11/32	5.550	.290	25° Tulip-Hard Tip optional. +.600
F1650	I	2.020	11/32	4.960	.290	12° Hard Tip optional. Stock
F1651	I	2.020	11/32	5.040	.290	12° Hard Tip optional. +.100
F1349	I	2.055	11/32	4.960	.290	12° Hard Tip optional. Stock
F1652	I	2.055	11/32	5.040	.290	12° Hard Tip optional. +.100
F1314	I	2.080	11/32	4.960	.290	12° Hard Tip optional. Stock
F1350	I	2.080	11/32	5.040	.290	12° Hard Tip optional. +.100
F1356	I	2.080	11/32	5.140	.290	12° Hard Tip optional. +.200
F1653	I	2.080	11/32	5.240	.290	12° Hard Tip optional. +.300
F1654	I	2.080	11/32	5.340	.290	12° Hard Tip optional. +.400
F1318	I	2.100	11/32	4.960	.290	12° Hard Tip optional. Stock
F1319	I	2.100	11/32	5.040	.290	12° Hard Tip optional. +.100
F1358	I	2.100	11/32	5.140	.290	12° Hard Tip optional. +.200
F1655	I	2.100	11/32	5.240	.290	12° Hard Tip optional. +.300
F1656	I	2.100	11/32	5.285	.290	12° Hard Tip optional-Yates Head
F1657	I	2.100	11/32	5.340	.290	12° Hard Tip optional. +.400
F1658	I	2.100	11/32	5.450	.290	12° Hard Tip optional. +.500
F1659	I	2.100	11/32	5.550	.290	12° Hard Tip optional. +.600
F1355	I	2.125	11/32	5.040	.290	12° Hard Tip optional. +.100
F1357	I	2.125	11/32	5.140	.290	12° Hard Tip optional. +.200
F1661	I	2.125	11/32	5.240	.290	12° Hard Tip optional. +.300
F1660	I	2.125	11/32	5.285	.290	12° Hard Tip optional-Yates Head
F1662	I	2.125	11/32	5.340	.290	12° Hard Tip optional. +.400
F1663	I	2.125	11/32	5.450	.290	12° Hard Tip optional. +.500
F1363	I	2.125	11/32	5.550	.290	12° Hard Tip optional. +.600
F1612	I	2.150	11/32	5.040	.290	12° Hard Tip optional. +.100
F1360	I	2.150	11/32	5.140	.290	12° Hard Tip optional. +.200
F1664	I	2.150	11/32	5.240	.290	12° Hard Tip optional. +.300
F1665	I	2.150	11/32	5.340	.290	12° Hard Tip optional. +.400
F1359	I	2.150	11/32	5.450	.290	12° Hard Tip optional. +.500

(* Additional wear resistant coatings such as CrN or H-DLC can be applied to valve seat and/or tip areas at an extra charge. Please contact a Ferrea sales representative for pricing.

TITANIUM COMPETITION VALVES

Part#	Type	Head Diam.	Stem Diam.	Overall Length	Tip Length	References
CHEVROLET, CHRYSLER, FORD (SMALL BLOCK 11/32)						
F1614	I	2.150	11/32	5.550	.290	12° Hard Tip optional. +.600
F1317	I	2.170	11/32	5.340	.290	12° Hard Tip optional. +.400
F1666	I	2.200	11/32	5.340	.290	12° Hard Tip optional. +.400
F1667	I	2.200	11/32	5.450	.290	12° Hard Tip optional. +.500
F1365	I	2.200	11/32	5.550	.290	12° Hard Tip optional. +.600
F1668	I	2.200	11/32	5.810	.290	12° Hard Tip optional-Splayed Head
F1669	I	2.250	11/32	6.200	.290	12° Hard Tip optional-Brodix CVSP

CHEVROLET SMALL BLOCK - LSX (DR HEAD)

F1648	I	2.250	.310	6.290	.300	13° Flo. Hard Tip. Radial Groove. Stock
F6879	I	2.250	.310	6.290	.300	13° Flo. Hard Tip. Radial Groove. GM Part # 19259049

HONDA CRF 450 (2002-2006) - MOTOCROSS

F0410	I	36 mm	5.48 mm	84.63 mm	1.15 mm	20° Flo. Dish Head. Stock size.
F0409	I	37 mm	5.48 mm	84.63 mm	1.15 mm	20° Flo. Dish Head. - 1mm oversize
F0408	I	38 mm	5.48 mm	84.63 mm	1.15 mm	20° Flo. Dish Head. + 2mm oversize.

HONDA CRF 450 (2007-2008) - MOTOCROSS

F0410	I	36 mm	5.48 mm	84.63 mm	1.15 mm	20° Flo. Dish Head. Stock size.
F0409	I	37 mm	5.48 mm	84.63 mm	1.15 mm	20° Flo. Dish Head. - 1mm oversize.
F0408	I	38 mm	5.48 mm	84.63 mm	1.15 mm	20° Flo-Dish Head. + 2mm oversize.

KAWASAKI 250 (2004) - MOTOCROSS

F0412	E	25 mm	4.46 mm	79.1 mm	1.03 mm	25° Flo. Stock
F0414	E	26 mm	4.46 mm	79.1 mm	1.03 mm	25° Flo. + 1mm oversize
F0411	I	31 mm	4.48 mm	78.93 mm	1.03 mm	20° Flo. Stock
F0413	I	32 mm	4.48 mm	78.93 mm	1.03 mm	20° Flo. + 1mm oversize

SUZUKI 250 (2004) - MOTOCROSS

F0412	E	25 mm	4.46 mm	79.1 mm	1.03 mm	25° Flo. Stock
F0414	E	26 mm	4.46 mm	79.1 mm	1.03 mm	25° Flo. + 1mm oversize
F0411	I	31 mm	4.48 mm	78.93 mm	1.03 mm	20° Flo. Stock
F0413	I	32 mm	4.48 mm	78.93 mm	1.03 mm	20° Flo. + 1mm oversize

SUZUKI GSXR 750 - ROAD RACE

F0088	E	24 mm	4.5 mm	96.4 mm	1.6 mm	15° Flo
F0087	I	29 mm	4.5 mm	96.3 mm	1.6 mm	15° Flo

TITANIUM COMPETITION VALVES - BLANKS

Part#	Type	Head Diam.	Stem Diam.	Overall Length	Tip Length	References
BLANKS (5/16)						
F1361	E	1.650	5/16	7.000	BLANK	15° Taper Flo
F1697	E	1.800	5/16	7.250	BLANK	22° Taper Flo.
F1384	E	2.000	5/16	7.000	BLANK	22° Tulip Flo
F1398	E	2.000	5/16	7.250	BLANK	31° Tulip Taper Flo
F1393	I	2.250	5/16	7.000	BLANK	13° Super Flo
F0084	E/I	2.300	5/16	7.000	BLANK	25° Flo
F1394	I	2.375	5/16	7.000	BLANK	13° Super Flo
F1385	I	2.500	5/16	7.000	BLANK	13° Super Flo
F1399	I	2.600	5/16	7.250	BLANK	13° Super Flo
F1695	I	2.700	5/16	7.000	BLANK	12° Flo - Pro Stock
F1696	I	2.800	5/16	7.000	BLANK	12° Flo - Pro Stock
BLANKS (.311)						
F1647	E	1.650	.311	7.000	BLANK	15° Taper Flo
F1643	E	2.000	.311	7.250	BLANK	31° Tulip Taper Flo
F1644	I	2.250	.311	7.000	BLANK	13° Super Flo
F1641	I	2.375	.311	7.000	BLANK	13° Super Flo
F1642	I	2.600	.311	7.250	BLANK	13° Super Flo
BLANKS (.3135)						
F1769	I	2.250	.3135	7.000	BLANK	12° S. Flo. Lightweight. LS1 and LS7
F1791	I	2.250	.3135	7.000	BLANK	12° S. Flo. Flat Face. LS1 and LS7
BLANKS (11/32)						
F1376	E	1.625	11/32	7.000	BLANK	20° Semi Tulip Flo
F1386	E	1.650	11/32	7.000	BLANK	30° Tulip Flo
F1306	E	1.650	11/32	7.000	BLANK	25° Tulip Taper Flo
F1373	E	1.650	11/32	7.000	BLANK	15° Taper Flo
F1336	E	1.800	11/32	7.000	BLANK	28° Tulip Taper Flo
F1378	E	1.940	11/32	7.000	BLANK	28° Tulip Taper Flo
F1383	E	2.000	11/32	7.000	BLANK	31° Tulip Taper Flo
F1397	E	2.000	11/32	7.000	BLANK	28° Tulip Taper Flo
F1783	E	2.000	11/32	7.500	BLANK	31° Tulip Taper Flo
F1396	E	2.200	11/32	7.000	BLANK	25° Tulip Taper Flo

(* Additional wear resistant coatings such as CrN or H-DLC can be applied to valve seat and/or tip areas at an extra charge. Please contact a Ferrea sales representative for pricing.

TITANIUM COMPETITION VALVES - BLANKS

Part#	Type	Head Diam.	Stem Diam.	Overall Length	Tip Length	References
BLANKS (11/32)						
F1387	I	2.150	11/32	7.000	BLANK	12° Super Flo
F1381	I	2.200	11/32	7.000	BLANK	12° Super Flo
F1335	I	2.250	11/32	7.000	BLANK	12° Super Flo
F1380	I	2.375	11/32	7.000	BLANK	13° Super Flo
F1379	I	2.500	11/32	7.000	BLANK	25° Tulip Super Flo
F1382	I	2.500	11/32	7.000	BLANK	13° Super Flo
F1782	I	2.500	11/32	7.500	BLANK	13° Super Flo
F1391	I	2.600	11/32	7.500	BLANK	25° Tulip Super Flo
F1390	I	2.600	11/32	7.500	BLANK	13° Super Flo
F1790	I	2.700	11/32	7.500	BLANK	13° Super Flo
F1645	I	2.800	11/32	7.500	BLANK	13° Super Flo
F1646	I	3.000	11/32	7.500	BLANK	13° Super Flo
BLANKS (HARLEY DAVIDSON - DRAG RACE)						
F1384	E	2.000	5/16	7.000	BLANK	22° Tulip Flo
F0084	E/I	2.300	5/16	6.500	BLANK	25° Flo.
F1383	E	2.000	11/32	7.000	BLANK	31° Tulip Taper Flo
F1379	I	2.500	11/32	7.000	BLANK	25° Tulip Super Flo
BLANKS (METRIC) 4-5 mm						
F0426	E	26 mm	3.97mm	100mm	BLANK	20° Back angle. Flo. Hi Temp.
F0427	E	28 mm	3.97mm	100mm	BLANK	20° Back angle. Flo. Hi Temp.
F0432	I	30 mm	3.98mm	100mm	BLANK	17° Back angle. Flo.
F0433	I	32 mm	3.98mm	100mm	BLANK	17° Back angle. Flo.
F0430	E	26 mm	4.46mm	100mm	BLANK	22° Back angle. Flo. Hi Temp.
F0431	E	28 mm	4.46mm	100mm	BLANK	22° Back angle. Overcut Flo. Hi Temp.
F0428	I	32 mm	4.48mm	100mm	BLANK	20° Back angle. Flo.
F0429	I	34 mm	4.48mm	100mm	BLANK	20° Back angle. Flo.
BLANKS (METRIC) 5-6 mm						
F0404	E	30 mm	4.98mm	135mm	BLANK	20° Flo Hi Temp
F0403	I	35 mm	4.98mm	135mm	BLANK	17° Super Flo
F0255	E	33mm	5.47mm	135mm	BLANK	19° Flat Head
F0254	I	41mm	5.48mm	135mm	BLANK	15° Flat Head
F0042	E	32mm	5.5mm	145mm	BLANK	26° Tulip Flo
F0424	E	34mm	5.5mm	145mm	BLANK	30° Indy (IRL AURORA)
F0043	I	38mm	5.5mm	135mm	BLANK	26° Tulip Super Flo
F0423	I	41mm	5.5mm	145mm	BLANK	12° Indy (IRL AURORA)
F0235	E	34mm	5.95mm	135mm	BLANK	21° Flo Dish Head
F0234	I	40mm	5.97mm	135mm	BLANK	19° Super Flo-Flat Head
F0405	E	40mm	5.98mm	135mm	BLANK	16° Flo
F0407	E	40mm	5.98mm	135mm	BLANK	25° Flo
F0436	I	40mm	5.98mm	145mm	BLANK	12° Taper Flo. Flat Head
F0437	E/I	45mm	5.98mm	145mm	BLANK	12° Flo. Flat Head
F0406	E/I	50mm	5.98mm	145mm	BLANK	12° Flo
BLANKS (METRIC) 7 mm						
F0040	E	40mm	7mm	135mm	BLANK	26° Tulip Super Flo-Pro Stock Motorcycle
F0400	E	40mm	7mm	135mm	BLANK	30° Tulip Super Flo-Pro Stock Motorcycle
F1770	E	1.650	7mm	7.000	BLANK	25° Tulip Super NASCAR. Hi Temp.
F0041	I	50mm	7mm	135mm	BLANK	25° Tulip Super Flo-Pro Stock Motorcycle
F0056	I	50mm	7mm	135mm	BLANK	15° Super Flo-Pro Stock Motorcycle
F0420	I	50mm	7mm	135mm	BLANK	19° Super Flo-Pro Stock Motorcycle
F1759	I	2.200	7mm	7.000	BLANK	12° Dish Head-Nascar Hi Temp
F0422	E	32.5mm	7.095mm	145mm	BLANK	30° INDY RL AURORA
F0421	I	39mm	7.1mm	145mm	BLANK	19° INDY RL AURORA
BLANKS (METRIC) 8 mm						
F1372	E	40.65mm	8mm	145mm	BLANK	26° Tulip
F1370	I	52.80mm	8mm	145mm	BLANK	19° Semi Tulip

DOMESTIC APPLICATIONS

(*) Additional wear resistant coatings such as CrN or H-DLC can be applied to valve seat and/or tip areas at an extra charge. Please contact a Ferrea sales representative for pricing.

SUPER ALLOY VALVES

Part#	Type	Head Diam.	Stem Diam.	Overall Length	Tip Length	References
CHEVROLET BIG BLOCK (11/32)						
F1261P	E	1.880	11/32	5.450	.250	22° Super Flo. GM/Edelbrock. Super Alloy
F1271P	E	1.880	11/32	5.450	.250	22° Super Flo. GM/Edelbrock. Light weight. Super Alloy
F1270P	E	1.900	11/32	5.450	.250	22° Taper Flo-Marine/Drag
F1276P	E	1.900	11/32	5.450	.250	22° Flo-Marine/Drag-Sup Alloy-BBC
F1260P	E	1.940	11/32	5.450	.250	22° Flo-Marine/Drag-Sup Alloy-BBC
CHEVROLET BIG BLOCK (3/8)						
F2120P	E	1.890	3/8	5.400	.225	22° Tulip Flo-Super Alloy-Marine application-BBC
F2121P	E	1.940	3/8	5.400	.225	22° Tulip Flo-Super Alloy-Marine application-BBC
CHEVROLET SMALL BLOCK (7 mm)						
F2212P	E	1.600	7 mm	5.010	.290	24° Flo. Ultra Light - Super Alloy, Radial Groove
F2214P	E	1.600	7 mm	5.010	.290	12° Flo. Ultra Light - Super Alloy, Radial Groove
F1460P	E	1.600	7mm	5.160	.290	12° Super Alloy. Rad Groove. 23°. +.200
F1463P	E	1.600	7mm	5.160	.290	24° Tulip. Super Alloy. Rad Groove. 23°. +.200
F1466P	E	1.600	7mm	5.160	.290	12° Super Alloy. 23°. +.200
F1469P	E	1.600	7mm	5.160	.290	24° Tulip. Super Alloy. 23°. +.200
F1461P	E	1.600	7mm	5.380	.290	12° Super Alloy. Rad Groove. #12 & 18°. +.400
F1464P	E	1.600	7mm	5.380	.290	24° Tulip. Super Alloy. Rad Groove. #12 & 18°. +.400
F1467P	E	1.600	7mm	5.380	.290	12° NASCAR Super Alloy
F1471P	E	1.600	7mm	5.550	.290	24° Tulip. Super Alloy. 18°. +.600
F1462P	E	1.600	7mm	5.550	.290	12° Super Alloy. Rad Groove. 18°. +.600
F1465P	E	1.600	7mm	5.550	.290	24° Tulip. Super Alloy. Rad Groove. 18°. +.600
F1468P	E	1.600	7mm	5.550	.290	12° Super Alloy. 18°. +.600
CHEVROLET SMALL BLOCK (5/16)						
F1474P	E	1.600	5/16	5.380	.290	12° NASCAR Super Alloy. +.400
F1134P	E	1.650	5/16	5.010	.250	12° Flo-NASCAR-Hi Temp-Inconel. +.100
CHEVROLET SMALL BLOCK (11/32)						
F1476P	E	1.600	11/32	4.960	.250	12° Super Flo. Super Alloy. +.050
F2432P	E	1.600	11/32	5.010	.250	12° Super Flo. Super Alloy. +.100
F1479P	E	1.600	11/32	5.060	.250	12° Super Flo. Super Alloy. +.150
F1480P	E	1.600	11/32	5.160	.250	12° Super Flo. Super Alloy. 23°. +.250
F1477P	E	1.600	11/32	5.300	.250	12° Super Flo. Super Alloy. #12
F1484P	E	1.600	11/32	5.350	.250	12° Super Flo. Super Alloy. #12 & 18°. +.400
F1485P	E	1.600	11/32	5.460	.250	12° Super Flo. Super Alloy. 18°. +.500
F1482P	E	1.600	11/32	5.560	.250	12° Super Flo. Super Alloy. 18°. +.600
F1481P	E	1.625	11/32	5.350	.250	12° Super Flo. Super Alloy. #12 & 18°. +.400
F1478P	E	1.625	11/32	5.460	.250	12° Super Flo. Super Alloy. 18°. +.500
F1483P	E	1.625	11/32	5.560	.250	12° Super Flo. Super Alloy. 18°. +.600
CHEVROLET SMALL BLOCK - LS1						
F1894P	E	1.550	.313	4.915	.160	15° S.Flo.Rad.Grov.Sup.Alloy.Turbo Application
F1893P	E	1.600	.313	4.915	.160	15° S.Flo.Rad.Grov.Sup.Alloy.Turbo Application
F1892P	E	1.600	.313	4.915	.160	24° S.Flo.Rad.Grov.Sup.Alloy.Turbo Application
CHEVROLET SMALL BLOCK - LS7						
F1598P	E	1.615	.313	5.227	.290	15° S.Flo.Rad.Grov.Sup.Alloy.Turbo Application
F1597P	E	1.615	.313	5.227	.290	24° S.Flo.Rad.Grov.Sup.Alloy.Turbo Application
CHEVROLET SMALL BLOCK - LSX (DR HEAD)						
F2043P	E	1.625	.310	6.400	.380	24° Taper Flo. Radius Groove. Super Alloy. Stk size. Hollow Stem Valve
F2355P	E	1.625	.310	6.400	.380	24° Taper Flo. Radius Groove. Super Alloy.
CHEVROLET SMALL BLOCK - LT1 - GEN 5						
F2410P	E	1.600	.313	5.200	.160	24° Super Flo. Radial Groove. Super Alloy. Stk size
CHRYSLER HEMI - DART/BAE/AJR HEADS (11/32)						
F1526P	E	1.900	11/32	5.019	.250	22° Flo-DART/55° Seat-Turbo/T Fuel/Funny Car-Hi Temp Super Alloy-CHRY HEMI
F1527P	E	1.950	11/32	5.019	.250	22° Flo-DART/BAE/AJR-50° Seat-Turbo/ T Fuel/Funny Car-Hi Temp (Super Alloy) Requires Lash caps
F1535P	E	1.950	11/32	5.019	.250	22° Flo - 55° Seat (Super Alloy) T/F-F/C
F1506P	E	2.000	11/32	5.019	.250	22° Flo-DART/BAE/AJR-45° Seat-Turbo/T Fuel/ Funny Car-Hi Temp Super Alloy-CHRY HEMI
CHRYSLER HEMI - DART/BAE/AJR HEADS (3/8)						
F1531P	E	1.900	3/8	5.019	.250	22° Flo - 55° Seat (Super Alloy) T/F-F/C
F1533P	E	1.900	3/8	5.119	.250	22° Flo - 55° Seat (Super Alloy) T/F-F/C
F1537P	E	1.925	3/8	4.990	.250	22° Flo. 55° Seat. - Super Alloy. T/F - F/C
F2158P	E	1.925	3/8	5.019	.250	22° Flo. 55° Seat. 38° Backcut. - Super Alloy. T/F - F/C
F1536P	E	1.925	3/8	5.119	.250	22° Flo. 55° Seat / 38° Backcut. Sup. Alloy. T/F-F/C
F1571P	E	1.925	3/8	5.119	.250	22° Flo. 55° Seat. Radial Groove. Sup Alloy. T/F-F/C
F1532P	E	1.950	3/8	5.019	.250	22° Flo - 55° Seat (Super Alloy) T/F-F/C
F1570P	E	1.950	3/8	5.019	.250	22° Flo. 55° Seat. Radial Groove. Sup Alloy. T/F-F/C
F1529P	E	1.950	3/8	5.119	.250	22° Flo - 50° Seat (Super Alloy) - Funny Car/Top Fuel
F1534P	E	1.950	3/8	5.119	.250	22° Flo - 55° Seat (Super Alloy) T/F-F/C
F1507P	E	2.000	3/8	5.019	.250	22° Flo. Super Alloy.Funny Car/Top Fuel-CHRY HEMI
F1528P	E	2.000	3/8	5.119	.250	22° Flo-DART/55° Seat-Turbo/T Fuel/Funny Car-Hi Temp (Super Alloy)

SUPER ALLOY VALVES

Part#	Type	Head Diam.	Stem Diam.	Overall Length	Tip Length	References
FORD ECOBOOST 2.3L - DOHC 16 VALVE - 2015						
F2370P	E	30mm	5.46mm	104.75mm	3.75mm	25° Taper Flo. Stock. Super Alloy
F2371P	E	30.5mm	5.46mm	104.75mm	3.75mm	25° Taper Flo. +.5mm Oversize. Super Alloy
FORD ECOBOOST 3.5L - DOHC 24 VALVE - 2010-2016						
F2399P	E	31mm	5.47mm	95.40mm	3.8mm	22° Taper Flo. Stock. Super Alloy Turbo
F2400P	E	32mm	5.47mm	95.40mm	3.8mm	22° Taper Flo. +1mm Oversize. Super Alloy Turbo
FORD 4.6 - 16 VALVES						
F2198P	E	1.450	.274	4.656	.466	14° Taper Flo. 3 Radial Grooves Stock. Super Alloy
FORD 4.6L/5.4L - SOHC V8 - 24 VALVES - 2005-2007						
F1188P	E	1.474	.235	4.580	.472	21° Flo. Stk siz. Super Alloy. Single Groove. 1 Valve required
F1189P	E	1.553	.235	4.580	.472	21° Flo. Oversize. Super Alloy. Single Groove. 1 Valve required

Tech Note: These Ferrea Racing Valves come with single radial grooves. These valves required Ferrea Valve Spring #10102, Ferrea Titanium #E11069 and both Ferrea Spring Seat Locator #SL1055 and Factory supply Spring Seat Locator and Ferrea Valve Lock #K10077. For racing applications Ferrea Racing does not recommend the use of triple radial groove valves.

FORD COYOTE 5.0L - DOHC 32 VALVE - 2010-2014

F2244P	E	1.222	.2346	4.275	.300	25° Taper Flo. 3 Radial Groove. Stock. Super Alloy
F2245P	E	1.262	.2346	4.275	.300	25° Taper Flo. 3 Radial Groove. Oversize. Super Alloy

FORD COYOTE 5.0L - DOHC 32 VALVES - 2015-2017

F2383P	E	1.250	.235	4.275	.300	20° Taper Flo. 3 Radial Groove. Stock. Super Alloy. 45° Seat
--------	---	-------	------	-------	------	--

FORD COYOTE 5.0L - DOHC 32 VALVES - 2018-2019

F2423P	E	1.260	.2345	4.315	.280	21° Taper Flo. 3 Radial Groove. Stock. Super Alloy
F2424P	E	1.300	.2345	4.315	.280	21° Taper Flo. 3 Radial Groove. +1mm Oversize. Super Alloy
F2425P	E	1.260	.2345	4.315	.280	21° Taper Flo. 3 Radial Groove. Stock. Super Alloy. 40° Seat

FORD VOODOO 5.2L - DOHC 32 VALVE (GT350) - 2015-2017

F2403P	E	1.280	.2345	4.325	.250	21° Taper Flo. 3 Radial Groove. Stock. Super Alloy
F2409P	E	1.280	.2345	4.325	.250	21° Taper Flo. 3 Radial Groove. Stock. Super Alloy. 40° Seat
F2404P	E	1.320	.2345	4.325	.250	21° Taper Flo. 3 Radial Groove. +1mm Oversize. Super Alloy

FORD GT 500 5.4L - 32 VALVES - 2005-2007

F2164P	E	1.260	.275	4.635	.390	15° Flo. Super Alloy. 3 Radial Groove. Stock
--------	---	-------	------	-------	------	--

SUPER ALLOY VALVES - BLANKS

Part#	Type	Head Diam.	Stem Diam.	Overall Length	Tip Length	References
BLANKS (5/16) ("REQUIRE LASH CAPS or HARD TIPS")						
F1475P	E	1.650	5/16	6.600	BLANK	12° Super Flo. Dish Head
F1487P	E	1.650	5/16	6.300	BLANK	24° Tulip Flo. Dish Head
F2354P	E	1.800	5/16	7.000	BLANK	24° Tulip Flo. Dish Head. Super Alloy
F2392P	E	2.000	5/16	7.000	BLANK	22° Tulip Flo. Finished. No groove. Super Alloy
BLANKS (11/32) ("REQUIRE LASH CAPS or HARD TIPS")						
F1590P	E	1.650	11/32	7.000	BLANK	23.5° Tulip Flo. Dish Head. Super Alloy
F1589P	E	1.800	11/32	7.000	BLANK	23.5 Tulip Flo. Dish Head. Super Alloy
F2347P	E	1.940	11/32	7.000	BLANK	22.5° Tulip Taper Flo. Dish Head. Super Alloy
F1509P	E	2.000	11/32	7.000	BLANK	23.5° Tulip Taper Flo. Dish Head. Super Alloy
F2348P	E	2.000	11/32	7.500	BLANK	15° Flo. Flat Head. Super Alloy
BLANKS (3/8) ("REQUIRE LASH CAPS or HARD TIPS")						
F2385P	E	1.800	3/8	7.500	BLANK	22° Tulip Taper Flo. 50° Seat. Flat Head. Super Alloy
F1572P	E	1.925	3/8	5.219	BLANK	22.5° Tulip Flo. Dish Head. Super Alloy
F1530P	E	1.950	3/8	5.170	BLANK	22° Flo - 55° Seat (Super Alloy) T/F-F/C
F2372P	E	2.000	3/8	7.500	BLANK	22° Flo. 45° Seat. Flat Head. Super Alloy
F2384P	E	2.000	3/8	7.500	BLANK	22° Tulip Taper Flo. 50° Seat. Flat Head. Super Alloy
F1511P	E	2.100	3/8	7.000	BLANK	22° Tulip Flo. Dish Head. Super Alloy
F2229P	E	2.250	3/8	7.500	BLANK	22° Tulip Taper Flo. 50° Seat. Flat Head. Super Alloy
BLANKS 5-6 mm ("REQUIRE LASH CAPS or HARD TIPS")						
F2415P	E	34 mm	5.46mm	145mm	BLANK	25° Taper Flo. Super Alloy
F1996P	E	38 mm	5.975mm	150.00mm	BLANK	21° Tulip Taper Flo. Dish Head. Super Alloy
BLANKS (7 mm) ("REQUIRE LASH CAPS or HARD TIPS")						
F0345	E	33mm	7mm	135mm	BLANK	22.5° Tulip Flo. Super Alloy
F0346	E	39mm	7mm	135mm	BLANK	22.5° Tulip Flo. Dish Head. Super Alloy
F1472P	E	1.625	7mm	6.300	BLANK	12° Taper Flo. Dish Head. Super Alloy
F1493P	E	1.650	7mm	6.300	BLANK	24° Tulip Flo. Dish Head. Super Alloy
BLANKS (.313/.3135/8 mm) ("REQUIRE LASH CAPS or HARD TIPS")						
F2159P	E	1.650	.313	6.000	BLANK	15° Flo. Super Alloy. GM LS1/LS7/L92
F1599P	E	1.650	.313	6.000	BLANK	24° Tulip Flo. Dish Head. Super Alloy. GM LS1/LS7/L92
F2172P	E	1.800	.3135	7.000	BLANK	4° Taper Flo. Flat Head. Super Alloy

COMPETITION PLUS - HOLLOW STEM VALVES

Part#	Type	Head Diam.	Stem Diam.	Overall Length	Tip Length	References
CHEVROLET, CHRYSLER, FORD (BIG BLOCK 11/32)						
F1051P	E	1.880	11/32	5.450	.250	22° Flo. Radial Groove. Special Alloy. +.100
F1061P	I	2.190	11/32	5.300	.250	12° Super Flo. Radial Groove. Special Alloy. +.050
F1048P	I	2.250	11/32	5.271	.250	12° Super Flo. Radial Groove. Special Alloy. +.050
F1049P	I	2.250	11/32	5.350	.250	12° Super Flo. Radial Groove. Special Alloy. +.100
F1050P	I	2.250	11/32	5.471	.250	12° Super Flo. Radial Groove. Special Alloy. +.250
F2057P	I	2.300	11/32	5.421	.250	12° Super Flo. Radial Groove. Special Alloy. +.200
F2058P	I	2.300	11/32	5.471	.250	12° Super Flo. Radial Groove. Special Alloy. +.250
CHEVROLET, CHRYSLER, FORD (BIG BLOCK 3/8)						
F1060P	E	1.880	3/8	5.400	.225	22° Super Flo. Special Alloy. +.050
F1066P	E	1.900	3/8	5.019	.250	22° Flo. 55° Seat T/F-F/C Super Alloy.
F1064P	E	1.950	3/8	5.019	.250	22° Flo. 55° Seat T/F-F/C Super Alloy.
F1065P	E	1.950	3/8	5.119	.250	22° Flo. 55° Seat T/F-F/C Super Alloy.
F1062P	I	2.190	3/8	5.300	.225	12° Super Flo. Special Alloy. +.050
F1030P	I	2.250	3/8	5.300	.225	12° Super Flo. Special Alloy. +.050
CHEVROLET, CHRYSLER, FORD (SMALL BLOCK 5/16)						
F2026P	E	1.600	5/16	5.010	.250	14° Flo. Radial Groove. Special Alloy. +.100
F2031P	E	1.600	5/16	5.060	.250	14° Flo. Radial Groove. Special Alloy. +.150
F2032P	E	1.625	5/16	5.010	.250	14° Flo. Radial Groove. Special Alloy. +.100
F2033P	E	1.625	5/16	5.060	.250	24° Flo. Radial Groove. Special Alloy. +.150
F2034P	I	2.020	5/16	5.010	.250	10° Flo. Radial Groove. Special Alloy. +.100
F2035P	I	2.020	5/16	5.060	.250	10° Flo. Radial Groove. Special Alloy. +.150
F2036P	I	2.055	5/16	5.010	.250	10° Flo. Radial Groove. Special Alloy. +.100
F2037P	I	2.055	5/16	5.060	.250	10° Flo. Radial Groove. Special Alloy. +.150
CHEVROLET, CHRYSLER, FORD (SMALL BLOCK 11/32)						
F2039P	E	1.500	11/32	4.910	.250	14° Flo. Radial Groove. Special Alloy. Stock
F1089P	E	1.500	11/32	4.960	.250	14° Super Flo. Radial Groove. Special Alloy. +.050
F1094P	E	1.500	11/32	4.960	.250	14° Flo. Radial Groove. Special Alloy. +.050
F2044P	E	1.600	11/32	4.910	.250	14° Flo. Radial Groove. Special Alloy. Stock
F1014P	E	1.600	11/32	4.960	.250	24° Flo. Radial Groove. Special Alloy. +.050
F1096P	E	1.600	11/32	4.960	.250	14° Flo. Radial Groove. Special Alloy. +.050
F1024P	E	1.600	11/32	4.960	.250	14° Super Flo. Radial Groove. Special Alloy. +.050
F1012P	E	1.600	11/32	5.010	.250	24° Flo. Radial Groove. Special Alloy. +.100
F1097P	E	1.600	11/32	5.010	.250	14° Flo. Radial Groove. Special Alloy. +.100
F1092P	E	1.600	11/32	5.060	.250	14° Super Flo. Radial Groove. Special Alloy. +.150
F1093P	E	1.600	11/32	5.060	.250	24° Super Flo. Radial Groove. Special Alloy. +.150
F2002P	E	1.600	11/32	5.160	.250	14° Super Flo. Radial Groove. Special Alloy. +.250
F2040P	E	1.600	11/32	5.560	.250	14° Flo. Radial Groove. Special Alloy. +.600
F1011P	E	1.625	11/32	4.960	.250	24° Super Flo. Radial Groove. Special Alloy. +.050
F1025P	E	1.625	11/32	5.010	.250	14° Super Flo. Radial Groove. Special Alloy. +.100
F1010P	E	1.625	11/32	5.060	.250	24° Super Flo. Radial Groove. Special Alloy. +.150
F1041P	E	1.625	11/32	5.060	.250	14° Super Flo. Radial Groove. Special Alloy. +.150
F1002P	E	1.625	11/32	5.160	.250	24° Super Flo. Radial Groove. Special Alloy. +.250
F1042P	E	1.625	11/32	5.160	.250	14° Super Flo. Radial Groove. Special Alloy. +.250
F2029P	E	1.625	11/32	5.560	.250	14° Super Flo. Radial Groove. Special Alloy. +.600
F2030P	E	1.625	11/32	5.560	.250	24° Super Flo. Radial Groove. Special Alloy. +.600
F2038P	I	1.940	11/32	4.910	.250	10° Flo. Radial Groove. Special Alloy. Stock
F1090P	I	1.940	11/32	4.960	.250	12° Super Flo. Radial Groove. Special Alloy. +.050
F1095P	I	1.940	11/32	4.960	.250	12° Flo. Radial Groove. Special Alloy. +.050
F2045P	I	2.020	11/32	4.910	.250	10° Flo. Radial Groove. Special Alloy. Stock
F1005P	I	2.020	11/32	4.960	.250	12° Super Flo. Radial Groove. Special Alloy. +.050
F1006P	I	2.020	11/32	4.960	.250	12° Flo. Radial Groove. Special Alloy. +.050
F1007P	I	2.020	11/32	5.010	.250	12° Flo. Radial Groove. Special Alloy. +.100
F1004P	I	2.020	11/32	5.060	.250	12° Super Flo. Radial Groove. Special Alloy. +.150
F1003P	I	2.020	11/32	5.160	.250	12° Super Flo. Radial Groove. Special Alloy. +.250
F1068P	I	2.055	11/32	4.960	.250	12° Super Flo. Radial Groove. Special Alloy. +.050
F1063P	I	2.055	11/32	5.010	.250	12° Super Flo. Radial Groove. Special Alloy. +.100
F2052P	I	2.055	11/32	5.060	.250	12° Super Flo. Radial Groove. Special Alloy. +.150
F1067P	I	2.055	11/32	5.160	.250	12° Super Flo. Radial Groove. Special Alloy. +.250
F1009P	I	2.080	11/32	4.960	.250	12° Super Flo. Radial Groove. Special Alloy. +.050
F1046P	I	2.080	11/32	5.010	.250	12° Super Flo. Radial Groove. Special Alloy. +.100
F1008P	I	2.080	11/32	5.060	.250	12° Super Flo. Radial Groove. Special Alloy. +.150
F1001P	I	2.080	11/32	5.160	.250	12° Super Flo. Radial Groove. Special Alloy. +.250
F1032P	I	2.125	11/32	5.060	.250	12° Super Flo. Radial Groove. Special Alloy. +.150
F1033P	I	2.125	11/32	5.160	.250	12° Super Flo. Radial Groove. Special Alloy. +.150
F2027P	I	2.150	11/32	5.560	.250	12° Super Flo. Radial Groove. Special Alloy. +.600
F2028P	I	2.200	11/32	5.560	.250	12° Super Flo. Radial Groove. Special Alloy. +.600
CHEVROLET SMALL BLOCK - LS1						
F1021P	E	1.600	.313	4.915	.160	24° Tulip S.Flo.Rad.Grov.Spec.Alloy. Stock
F1045P	E	1.600	.313	5.015	.160	24° Tulip S.Flo.Rad.Grov.Spec.Alloy. +.100
F1098P	E	1.625	.313	4.915	.160	24° Super Flo. Radial Groove. Special Alloy. Stock
F1069P	E	1.625	.313	5.015	.160	24° Tulip S.Flo.Rad.Grov.Spec.Alloy. +.100
F1022P	I	2.020	.3135	4.900	.160	12° Super Flo. Radial Groove. Special Alloy. Stock
F1043P	I	2.055	.3135	4.900	.160	12° Super Flo. Radial Groove. Special Alloy. Stock
F1044P	I	2.055	.3135	5.000	.160	12° Super Flo. Radial Groove. Special Alloy. +.100
F1099P	I	2.080	.3135	4.900	.160	12° Super Flo. Radial Groove. Special Alloy. Stock
F1047P	I	2.080	.3135	5.000	.160	12° Super Flo. Radial Groove. Special Alloy. +.100
F1091P	I	2.100	.3135	4.900	.160	12° Super Flo. Radial Groove. Special Alloy. Stock
CHEVROLET SMALL BLOCK - LS7						
F2042P	E	1.615	.313	5.227	.290	24° Flo. Radius Groove. Special Alloy. Stk size
F2014P	I	2.200	.3135	5.180	.290	10° S Flo. Backcut 30° Radius Groove. Special Alloy. Stk size
CHEVROLET SMALL BLOCK - L92						
F2010P	I	2.165	.3135	4.900	.160	12° S Flo. Backcut 30° Radius Groove. Special Alloy. Stk size
F2011P	I	2.200	.3135	4.900	.160	12° S Flo. Backcut 30° Radius Groove. Special Alloy
CHEVROLET SMALL BLOCK - LSX (DR HEAD)						
F2043P	E	1.625	.310	6.400	.380	24° Taper Flo. Radius Groove. Super Alloy. Stk size

COMPETITION PLUS - HOLLOW STEM VALVES

Part#	Type	Head Diam.	Stem Diam.	Overall Length	Tip Length	References
CHEVROLET SMALL BLOCK - LT1 - GEN 5						
F2046P	E	1.600	.313	5.200	.160	24° Super Flo. Radial Groove. Special Alloy. Stk size
F2047P	I	2.125	.3135	5.235	.175	10° Super Flo. Backcut 30°. Radial Groove. Stk size
CHEVROLET SMALL BLOCK - LT4 - GM OEM REPLACEMENT						
F2055P	E	1.550	.3413	4.910	.285	10° Overcut Flo. GM OEM# 12551313
F2056P	I	2.000	.3413	4.890	.265	10° Overcut Flo. GM OEM# 12555331
FORD 427 CAMMER - SOHC (11/32)						
F2023P	E	1.900	11/32	5.660	.338	22° Super Flo. Radial Groove. Special Alloy
F2024P	I	2.350	11/32	5.471	.338	10° Super Flo. Radial Groove. Special Alloy

COMPETITION PLUS VALVES

Part#	Type	Head Diam.	Stem Diam.	Overall Length	Tip Length	References
BRIGGS & STRATTON						
F0074	I	1.378	.247	3.845	.235	10° Super Flo-Go Kart & Jr. Dragster
F0076	I	1.500	.247	3.845	.235	10° Super Flo-Go Kart & Jr. Dragster
CHEVROLET BIG BLOCK (5/16)						
F1230P	E	1.900	5/16	5.425	.250	15° Flo. +.100
F1244P	I	2.250	5/16	5.325	.250	12° Flo. +.100
F1240P	I	2.300	5/16	5.350	.250	12° Flo. +.100
CHEVROLET BIG BLOCK (11/32)						
F1201P	E	1.880	11/32	5.425	.250	15° Super Flo. +.100
F1261P	E	1.880	11/32	5.450	.250	22° Super Flo. GM/Edelbrock (Super Alloy)
F1271P	E	1.880	11/32	5.450	.250	22° Super Flo. GM/Edelbrock. Light weight. Super Alloy
F1206P	E	1.880	11/32	5.500	.250	15° Super Flo
F1231P	E	1.900	11/32	5.425	.250	18° Tulip Flo. +.100
F1267P	E	1.900	11/32	5.425	.250	14° BB5 Sonny Brodix
F1270P	E	1.900	11/32	5.450	.250	22° Taper Flo-Marine/Drag-(Super Alloy)
F1276P	E	1.900	11/32	5.450	.250	22° Super Flo. Light weight. Super Alloy
F1269P	E	1.900	11/32	5.500	.250	22° BB5 Sonny Brodix
F1272P	E	1.900	11/32	5.525	.250	22° Super Flo. Light weight. Super Alloy
F1216P	E	1.920	11/32	5.425	.250	14° Flo-Hi Temp Special Alloy. +.100
F1215P	E	1.920	11/32	5.450	.250	14° Super Flo. GM/Edelbrock
F1202P	E	1.940	11/32	5.425	.250	15° Super Flo. +.100
F1260P	E	1.940	11/32	5.450	.250	22° Flo-Marine/Drag-(Super Alloy)
F1268P	E	1.940	11/32	5.500	.250	22° BB5 Sonny Brodix
F1211P	I	2.190	11/32	5.300	.250	12° Super Flo. +.050
F1226P	I	2.190	11/32	5.346	.250	12° Super Flo. +.100
F1212P	I	2.250	11/32	5.300	.250	12° Super Flo. +.050. Marine/Drag
F1223P	I	2.250	11/32	5.350	.250	12° Super Flo. +.100
F1232P	I	2.250	11/32	5.471	.250	12° Super Flo. +.250
F1239P	I	2.250	11/32	5.625	.250	12° Super Flo. GM/Edelbrock/Brodix BB5. +.400
F2296P	I	2.300	11/32	5.350	.250	12° Super Flo. +.100. Marine/Drag
F1214P	I	2.300	11/32	5.421	.250	12° Super Flo. +.200
F1219P	I	2.300	11/32	5.471	.250	12° Super Flo. +.250
F1224P	I	2.300	11/32	5.525	.250	12° Super Flo. BB5 Sonny Brodix. +.300
F1234P	I	2.300	11/32	5.625	.250	12° Sup Flo. GM/Edelbrock/Brodix BB5. +.400
F1225P	I	2.350	11/32	5.471	.250	12° Super Flo. +.250. Marine/Drag
F2369P	I	2.350	11/32	5.525	.250	12° Super Flo. +.300
F2264P	I	2.350	11/32	5.625	.250	12° BB5 Sonny Brodix. +.400
CHEVROLET BIG BLOCK (3/8)						
F2101P	E	1.880	3/8	5.400	.225	15° Super Flo. +.050
F2103P	E	1.880	3/8	5.400	.225	15° Flo. +.050
F2107P	E	1.880	3/8	5.400	.225	22° Tulip Flo-Marine Normally Aspirated / Dry Exhaust
F2123P	E	1.880	3/8	5.450	.225	15° Super Flo. +.100
F2120P	E	1.890	3/8	5.400	.225	22° Tulip Flo-Inconel-Marine application. +.050
F2105P	E	1.910	3/8	5.400	.225	Super Flo-Marine Normally Aspirated / Dry Exhaust.+050
F2109P	E	1.920	3/8	5.400	.225	22° Tulip Flo-Marine application. +.050
F2121P	E	1.940	3/8	5.400	.225	22° Tulip Flo-Inconel-Marine application. +.050
F2102P	E	1.940	3/8	5.400	.225	15° Super Flo. +.050
F2124P	E	1.940	3/8	5.450	.225	22° Tulip Flo-Marine Normally Aspirated / Dry Exhaust.+100
F2111P	I	2.190	3/8	5.271	.225	12° Super Flo. +.050
F2114P	I	2.190	3/8	5.271	.225	12° Flo. +.050
F2119P	I	2.190	3/8	5.350	.225	12° Super Flo. +.130
F2112P	I	2.250	3/8	5.271	.225	12° Super Flo. +.050
F2115P	I	2.250	3/8	5.350	.225	12° Super Flo. +.130
F2117P	I	2.250	3/8	5.421	.225	12° Super Flo. +.200
F2118P	I	2.300	3/8	5.421	.225	12° Super Flo. +.200
F2116P	I	2.325	3/8	5.421	.225	12° Super Flo. +.200
CHEVROLET SMALL BLOCK (7 mm)						
F2212P	E	1.600	7 mm	5.010	.290	24° Flo. Ultra Light - Super Alloy. Radial Groove
F2214P	E	1.600	7 mm	5.010	.290	12° Flo. Ultra Light - Super Alloy. Radial Groove
F1460P	E	1.600	7mm	5.160	.290	12° (Super Alloy). Rad Groove. 23°. +.200
F1463P	E	1.600	7mm	5.160	.290	24° Tulip.(Super Alloy). Rad Groove. 23°. +.200
F1466P	E	1.600	7mm	5.160	.290	12° (Super Alloy). 23°. +.200
F1469P	E	1.600	7mm	5.160	.290	24° Tulip. (Super Alloy). 23°. +.200
F1461P	E	1.600	7mm	5.380	.290	12° (Super Alloy). Rad Groove. #12 & 18°. +.400
F1464P	E	1.600	7mm	5.380	.290	24° Tulip. (Super Alloy). Rad Groove. #12 & 18°. +.400
F1467P	E	1.600	7mm	5.380	.290	12° NASCAR (Super Alloy)
F1471P	E	1.600	7mm	5.550	.290	24° Tulip. (Super Alloy). 18°. +.600
F1462P	E	1.600	7mm	5.550	.290	12° (Super Alloy). Rad Groove. 18°. +.600
F1465P	E	1.600	7mm	5.550	.290	24° Tulip. (Super Alloy). Rad Groove. 18°. +.600
F1468P	E	1.600	7mm	5.550	.290	12° (Super Alloy). 18°. +.600
F2206PQ	I	2.020	7 mm	5.010	.290	12° Flo. Ultra Light Special Alloy. Radial Groove
F2210P	I	2.080	7 mm	4.960	.250	12° Flo. Ultra Light Special Alloy. Radial Groove
F2211P	I	2.080	7 mm	5.160	.250	12° Flo. Ultra Light Special Alloy. Radial Groove

DOMESTIC APPLICATIONS

COMPETITION PLUS VALVES

Part#	Type	Head Diam.	Stem Diam.	Overall Length	Tip Length	References
CHEVROLET SMALL BLOCK (7 mm)						
F1460P	E	1.600	7mm	5.160	.290	12° (Super Alloy). Rad Groove. 23°. +.200
F1463P	E	1.600	7mm	5.160	.290	24° Tulip.(Super Alloy). Rad Groove. 23°. +.200
F1466P	E	1.600	7mm	5.160	.290	12° (Super Alloy). 23°. +.200
F1469P	E	1.600	7mm	5.160	.290	24° Tulip. (Super Alloy). 23°. +.200
F1461P	E	1.600	7mm	5.380	.290	12° (Super Alloy). Rad Groove. #12 & 18°. +.400
F1464P	E	1.600	7mm	5.380	.290	24° Tulip. (Super Alloy). Rad Groove. #12 & 18°. +.400
F1467P	E	1.600	7mm	5.380	.290	12° NASCAR (Super Alloy)
F1471P	E	1.600	7mm	5.550	.290	24° Tulip. (Super Alloy). 18°. +.600
F1462P	E	1.600	7mm	5.550	.290	12° (Super Alloy). Rad Groove. 18°. +.600
F1465P	E	1.600	7mm	5.550	.290	24° Tulip. (Super Alloy). Rad Groove. 18°. +.600
F1468P	E	1.600	7mm	5.550	.290	12° (Super Alloy). 18°. +.600
CHEVROLET SMALL BLOCK (5/16)						
F2300P	E	1.600	5/16	5.010	.250	14° Flo. +.100
F2301P	E	1.600	5/16	5.060	.250	14° Flo. +.150
F2302P	E	1.600	5/16	5.160	.250	14° Super Flo-Brodix PONTIAC. +.200
F2303P	E	1.600	5/16	5.350	.250	14° Super Flo-Brodix #12. +.400
F1474P	E	1.600	5/16	5.380	.290	12° NASCAR (Super Alloy) FORD 302-351/Yates Head
F2304P	E	1.600	5/16	5.450	.250	14° Super Flo-Brodix/Dart 18°. +.500
F2305P	E	1.600	5/16	5.450	.250	14° Flo-Hi Temp-Brodix/Dart 18°. +.500
F1150P	E	1.625	5/16	5.010	.250	14° Flo. +.100
F1173P	E	1.625	5/16	5.160	.250	14° Super Flo-Brodix PONTIAC. +.200
F1176P	E	1.625	5/16	5.350	.250	14° Super Flo-Brodix #12. +.400
F1174P	E	1.625	5/16	5.450	.250	14° Super Flo-Brodix/Dart 18°. +.500
F1134P	E	1.650	5/16	5.010	.250	12° Flo-NASCAR-Hi Temp-Inconel. +.100
F1151P	E	1.650	5/16	5.060	.250	14° Flo. +.150
F1166P	I	2.020	5/16	5.010	.250	12° Super Flo. +.100
F2340P	I	2.080	5/16	5.010	.250	12° Flo. +.100
F2341P	I	2.080	5/16	5.060	.250	12° Flo. +.150
F2342P	I	2.080	5/16	5.160	.250	12° Super Flo-Brodix PONTIAC. +.200
F2343P	I	2.100	5/16	5.010	.250	12° Flo. +.100
F1168P	I	2.100	5/16	5.160	.250	12° Super Flo-Brodix PONTIAC. +.200
F2344P	I	2.100	5/16	5.275	.250	12° Super Flo-Yates Head
F2345P	I	2.100	5/16	5.450	.250	12° Super Flo-Brodix/Dart 18°. +.500
F1241P	I	2.125	5/16	5.010	.250	12° Flo. +.100
F1167P	I	2.125	5/16	5.160	.250	12° Super Flo. +.250
F1242P	I	2.125	5/16	5.275	.250	12° Flo-Yates Head
F1175P	I	2.125	5/16	5.450	.250	12° Super Flo-Brodix/Dart 18°. +.500
CHEVROLET SMALL BLOCK (11/32)						
F1882P	E	1.525	11/32	5.690	.250	20° Flo
F1145P	E	1.560	11/32	4.960	.250	14° Super Flo-Double Groove. +.050
F1100PQ	E	1.600	11/32	4.960	.250	14° Super Flo. +.050. Special Alloy
F1104PQ	E	1.600	11/32	4.960	.250	14° Flo. +.050. Special Alloy
F1476P	E	1.600	11/32	4.960	.250	12° Super Flo. (Super Alloy). +.050
F2217P	E	1.600	11/32	4.960	.250	9° Flat Head +.050
F2247P	E	1.600	11/32	4.960	.250	24° Super Flo. +.050 Light weight. Special Alloy. Radial Groove
F2200P	E	1.600	11/32	4.980	.250	16° Semi Tulip-TFS FORD. Stk.
F1102PQ	E	1.600	11/32	5.010	.250	14° Super Flo. +.100. Special Alloy
F2315P	E	1.600	11/32	5.010	.250	14° Super Flo. +.100. Special Alloy. Radial Groove
F1926P	E	1.600	11/32	5.010	.250	24° Tullip Flo. +.100
F2248P	E	1.600	11/32	5.010	.250	24° Super Flo. +.100. Light weight. Special Alloy. Radial Groove
F2432P	E	1.600	11/32	5.010	.250	12° Super Flo. Super Alloy. +.100
F1148PQ	E	1.600	11/32	5.060	.250	14° Super Flo. +.150. Special Alloy
F2316P	E	1.600	11/32	5.060	.250	14° Super Flo. +.150. Special Alloy. Radial Groove
F1187P	E	1.600	11/32	5.060	.250	19° Tulip Super Flo. +.150
F1479P	E	1.600	11/32	5.060	.250	12° Super Flo. (Super Alloy). +.150
F1810P	E	1.600	11/32	5.060	.250	24° Tulip Flo. +.150
F1179P	E	1.600	11/32	5.110	.250	14° Super Flo. +.200
F1140PQ	E	1.600	11/32	5.160	.250	14° Sup Flo-Brodix PONTIAC. +.200. Special Alloy
F2317P	E	1.600	11/32	5.160	.250	14° Sup Flo-Brodix PONTIAC. +.200. Special Alloy. Radial Groove
F1480P	E	1.600	11/32	5.160	.250	12° Super Flo. (Super Alloy). +.250
F1811P	E	1.600	11/32	5.160	.250	24° Tulip Flo. +.250
F1149PQ	E	1.600	11/32	5.300	.250	14° Super Flo-Brodix #12/Yates. Special Alloy
F1477P	E	1.600	11/32	5.300	.250	12° Super Flo. (Super Alloy). #12/Yates
F2218P	E	1.600	11/32	5.300	.250	24° Flo. TFS "R" Series
F1484P	E	1.600	11/32	5.350	.250	12° Super Flo. Super Alloy. #12. +.400
F2201P	E	1.600	11/32	5.350	.250	15° Super Flo. +.400
F1135PQ	E	1.600	11/32	5.400	.250	14° Super Flo-Brodix #12/Dart BUICK. Special Alloy
F1485P	E	1.600	11/32	5.460	.250	12° Super Flo.(Super Alloy) - Dart/Brodix #12 & 18° +.500
F2202P	E	1.600	11/32	5.460	.250	15° Super Flo-Hi Temp-Dart/Brodix #12 & 18°. +.500
F2203P	E	1.600	11/32	5.460	.250	20° Tulip Sup.Flo-Dart/Brodix #12 & 18°. +.500

COMPETITION PLUS VALVES

Part#	Type	Head Diam.	Stem Diam.	Overall Length	Tip Length	References
CHEVROLET SMALL BLOCK (11/32)						
F1156P	E	1.600	11/32	5.510	.250	14° Super Flo-Dart BUICK Head
F1256P	E	1.600	11/32	5.560	.250	14° Super Flo-Dart/Brodix 18°. +.600
F1482P	E	1.600	11/32	5.560	.250	12° Super Flo. (Super Alloy). 18°. +.600
F2216P	E	1.600	11/32	5.690	.250	20° Alan Johnson 18°
F1872P	E	1.600	11/32	5.725	.250	24° Flo. +.800
F2215P	E	1.600	11/32	6.090	.250	20° Canted Valve. Brodix CVSP
F1101P	E	1.625	11/32	4.960	.250	14° Super Flo. +.050
F1109P	E	1.625	11/32	4.980	.250	15° Semi Tulip Flo-TFS FORD
F1103PQ	E	1.625	11/32	5.010	.250	14° Super Flo. +.100. Special Alloy
F1108P	E	1.625	11/32	5.060	.250	20° Tulip Super Flo. +.150
F1812P	E	1.625	11/32	5.060	.250	24° Tulip Flo. +.150
F1128PQ	E	1.625	11/32	5.160	.250	14° Super Flo-Brodix PONTIAC. +.200. Special Alloy
F1814P	E	1.625	11/32	5.160	.250	24° Tulip Flo. +.250
F1152P	E	1.625	11/32	5.300	.250	14° Super Flo-Dart/Brodix #12
F2219P	E	1.625	11/32	5.300	.250	24° Flo. TFS "R" Series
F1172P	E	1.625	11/32	5.350	.250	14° Super Flo-Dart/Brodix #12. +.400
F1481P	E	1.625	11/32	5.350	.250	12° Super Flo. (Super Alloy). #12. +.400
F1155P	E	1.625	11/32	5.400	.250	15° Super Flo-Dart BUICK Head/Brodix #12
F1178P	E	1.625	11/32	5.460	.250	14° Super Flo-Hi Temp. Dart/Brodix 18°. +.500
F1478P	E	1.625	11/32	5.460	.250	12° Super Flo.(Super Alloy). 18°. +.500
F2204P	E	1.625	11/32	5.460	.250	20° Tulip Super Flo-Dart/Brodix 18°. +.500
F1157P	E	1.625	11/32	5.510	.250	14° Super Flo-Dart BUICK Head
F1257P	E	1.625	11/32	5.560	.250	14° Super Flo-Dart/Brodix 18°. +.600
F1483P	E	1.625	11/32	5.560	.250	12° Super Flo.(Super Alloy). 18°. +.600
F2220P	E	1.625	11/32	5.560	.250	24° Tulip-Brodix/Chapman/Dart 18°. +.600
F1880P	E	1.625	11/32	5.690	.250	20° Flo
F1873P	E	1.625	11/32	5.725	.250	24° Flo
F1877P	E	1.625	11/32	5.950	.250	24° Flo
F1133P	E	1.650	11/32	5.400	.250	14° Super Flo-Dart BUICK Head/Brodix #12
F1142P	E	1.650	11/32	5.490	.250	25° Tulip Super Flo-Dart BUICK
F1158P	E	1.650	11/32	5.510	.250	14° Super Flo-Dart BUICK
F2205P	E	1.650	11/32	5.560	.250	12° Super Flo-Brodix/Dart 18°. +.600
F1144P	I	2.000	11/32	4.960	.250	12° Super Flo-Double Groove. +.050
F1115P	I	2.020	11/32	4.960	.250	12° Super Flo. +.050
F2249P	I	2.020	11/32	4.960	.250	12° Super Flo. Backcut 35°. +.050. Light weight. Radial Groove
F2265P	I	2.020	11/32	4.960	.250	9° Flat Head. +.050
F1118P	I	2.020	11/32	5.010	.250	12° Super Flo. +.100
F2318P	I	2.020	11/32	5.010	.250	12° Super Flo. +.100. Radial Groove
F1277P	I	2.020	11/32	5.010	.250	12° Flo. Backcut 31°. +.100
F2250P	I	2.020	11/32	5.010	.250	12° Super Flo. Backcut 35°. +.100. Light weight. Radial Groove
F1804P	I	2.020	11/32	5.060	.250	12° Flo. +.150
F2321P	I	2.020	11/32	5.060	.250	12° Flo. +.150. Radial Groove
F1159P	I	2.020	11/32	5.110	.250	12° Aerodynamic Blades-Flow Control
F1807P	I	2.020	11/32	5.160	.250	12° Flo. +.250
F2322P	I	2.020	11/32	5.160	.250	12° Flo. +.250. Radial Groove
F2251P	I	2.020	11/32	5.160	.250	12° Super Flo. +.250
F2320P	I	2.020	11/32	5.160	.250	12° Super Flo. +.250. Radial Groove
F1111P	I	2.055	11/32	4.960	.250	12° Super Flo. +.050
F1112P	I	2.055	11/32	5.010	.250	12° Super Flo. +.100
F1805P	I	2.055	11/32	5.060	.250	12° Flo. +.150
F2319P	I	2.055	11/32	5.060	.250	12° Flo. +.150. Radial Groove
F2252P	I	2.055	11/32	5.060	.250	12° Super Flo. +.150
F2323P	I	2.055	11/32	5.060	.250	12° Super Flo. +.150. Radial Groove
F1808P	I	2.055	11/32	5.160	.250	12° Flo. +.250
F2324P	I	2.055	11/32	5.160	.250	12° Flo. +.250. Radial Groove
F2253P	I	2.055	11/32	5.160	.250	12° Super Flo. +.250
F2325P	I	2.055	11/32	5.160	.250	12° Super Flo. +.250. Radial Groove
F1121P	I	2.080	11/32	4.960	.250	12° Super Flo. +.050
F1114P	I	2.080	11/32	5.010	.250	12° Super Flo. +.100
F2326P	I	2.080	11/32	5.010	.250	12° Super Flo. +.100. Radial Groove
F1273P	I	2.080	11/32	5.010	.250	12° Flo. Backcut 35°. +.100
F2327P	I	2.080	11/32	5.010	.250	12° Flo. Backcut 35°. +.100. Radial Groove
F1147P	I	2.080	11/32	5.060	.250	12° Super Flo. +.150
F2328P	I	2.080	11/32	5.060	.250	12° Super Flo. +.150. Radial Groove
F1806P	I	2.080	11/32	5.060	.250	12° Flo. +.150
F2329P	I	2.080	11/32	5.060	.250	12° Flo. +.150. Radial Groove
F1139P	I	2.080	11/32	5.160	.250	12° Super Flo-Brodix PONTIAC. +.200
F2330P	I	2.080	11/32	5.160	.250	12° Super Flo-Brodix PONTIAC. +.200. Radial Groove
F1809P	I	2.080	11/32	5.160	.250	12° Flo. +.250
F2331P	I	2.080	11/32	5.160	.250	12° Flo. +.250. Radial Groove
F1238P	I	2.080	11/32	5.300	.250	12° Super Flo. TFS "R" Series

DOMESTIC APPLICATIONS

COMPETITION PLUS VALVES

Part#	Type	Head Diam.	Stem Diam.	Overall Length	Tip Length	References
CHEVROLET SMALL BLOCK (11/32)						
F1871P	I	2.100	11/32	4.960	.250	12° Super Flo. +.050
F1117P	I	2.100	11/32	5.010	.250	12° Super Flo. +.100
F2266P	I	2.100	11/32	5.060	.250	12° Super Flo. +.150
F1207P	I	2.100	11/32	5.160	.250	12° Super Flo. +.250
F1208P	I	2.100	11/32	5.300	.250	12° Super Flo-Brodix #12/Yates
F2254P	I	2.100	11/32	5.350	.250	12° Super Flo. +.450
F1132P	I	2.100	11/32	5.400	.250	12° Flo-Dart BUICK Head
F2255P	I	2.100	11/32	5.450	.250	12° Super Flo. +.550
F1123P	I	2.125	11/32	4.960	.250	12° Super Flo. +.050
F1119P	I	2.125	11/32	5.010	.250	12° Super Flo. +.100
F1146P	I	2.125	11/32	5.060	.250	12° Super Flo. +.150
F1127P	I	2.125	11/32	5.160	.250	12° Super Flo-Brodix PONTIAC. +.200
F1209P	I	2.125	11/32	5.300	.250	12° Super Flo-Brodix #12/Yates
F2256P	I	2.125	11/32	5.350	.250	12° Super Flo. +.450
F1221P	I	2.125	11/32	5.400	.250	12° Super Flo-Brodix #12
F2257P	I	2.125	11/32	5.450	.250	12° Super Flo-Brodix/Dart 18°. +.500
F1220P	I	2.150	11/32	5.300	.250	12° Super Flo-Brodix #12
F2258P	I	2.150	11/32	5.350	.250	12° Super Flo. +.450
F1252P	I	2.150	11/32	5.400	.250	12° Super Flo-Brodix #12
F1186P	I	2.150	11/32	5.450	.250	12° Super Flo-Brodix #12 & 18°. +.500
F2259P	I	2.150	11/32	5.560	.250	12° Super Flo-Brodix/Dart 18°. +.600
F1883P	I	2.150	11/32	5.690	.250	12° Super Flo
F1874P	I	2.150	11/32	5.725	.250	12° Super Flo
F2267P	I	2.180	11/32	5.560	.250	12° S Flo-Brodix/Chapman/Dart 18°. +.600
F1881P	I	2.180	11/32	5.690	.250	12° Super Flo
F1875P	I	2.180	11/32	5.725	.250	12° Super Flo
F1228P	I	2.200	11/32	5.160	.250	12° Super Flo-Brodix PONTIAC. +.200
F1229P	I	2.200	11/32	5.300	.250	12° Super Flo-Brodix #12/Yates
F1222P	I	2.200	11/32	5.400	.250	12° Super Flo-Brodix #12/Dart Buick
F2260P	I	2.200	11/32	5.460	.250	12° Super Flo-Brodix/Dart 18°. +.500
F2261P	I	2.200	11/32	5.560	.250	12° Super Flo-Brodix/Dart 18°. +.600
F1884P	I	2.200	11/32	5.690	.250	12° Super Flo
F1876P	I	2.200	11/32	5.725	.250	12° Super Flo
F2263P	I	2.200	11/32	5.840	.250	12° All Pro/Neal Ford Brodix
F1878P	I	2.200	11/32	5.950	.250	12° Super Flo
F1879P	I	2.200	11/32	6.035	.250	12° Super Flo
F2262P	I	2.250	11/32	6.200	.250	12° Canted Valve. Brodix CVSP
CHEVROLET SMALL BLOCK - LS1						
F1894P	E	1.550	.313	4.915	.160	15° S.Flo. Rad. Grov. Sup.Alloy. Turbo Application
F1893P	E	1.600	.313	4.915	.160	15° S.Flo. Rad. Grov. Sup.Alloy. Turbo Application
F1892P	E	1.600	.313	4.915	.160	24° S.Flo. Rad. Grov. Sup.Alloy. Turbo Application
CHEVROLET SMALL BLOCK - LS7						
F1598P	E	1.615	.313	5.227	.290	15° Flo. Rad. Grov. Sup.Alloy. Turbo Application
F1597P	E	1.615	.313	5.227	.290	24° Flo. Rad. Grov. Sup.Alloy. Turbo Application
CHEVROLET SMALL BLOCK - LSX (DR HEAD)						
F2355P	E	1.625	.310	6.400	.380	24° Taper Flo. Radius Groove. Super Alloy.
F6878	E	1.625	.310	6.400	.380	24° Taper Flo. Radius Groove. Special Alloy. GM Part #19259050
CHEVROLET SMALL BLOCK - LT1 - GEN 5						
F2410P	E	1.600	.313	5.200	.160	24° Super Flo. Radial Groove. Super Alloy. Stk size
CHRYSLER 440 CID (BRODIX HEAD)						
F1275P	E	1.780	11/32	5.400	.250	15° Super Flo-BI Head
F1266P	E	1.810	11/32	5.300	.250	15° Super Flo-BI BS Head
F1229P	I	2.200	11/32	5.300	.250	12° Super Flo-BI BS Head
CHRYSLER 440 CID (11/32) (INDY CYLINDER HEAD)						
F1885P	E	1.810	11/32	5.370	.250	15° Flo. 440 SR
F1886P	E	1.940	11/32	5.880	.250	15° Flo. 600-13 Series
F1226P	I	2.190	11/32	5.346	.250	12° Super Flo. +.100 - 440 SR
F1223P	I	2.250	11/32	5.350	.250	12° Super Flo. +.100 - 440 SR
F1887P	I	2.250	11/32	5.850	.250	12° Super Flo. 600-13 Series
CHRYSLER HEMI 426 CID (5/16)						
F2233P	E	1.900	5/16	4.910	.250	22° Tulip Flo. Radial Groove. Ray Barton
F1523P	E	1.900	5/16	5.040	.250	22° Tulip Flo. +.100
F2421P	E	1.940	5/16	4.890	.250	22° Flo. Radial Groove. Edelbrock
F1521P	E	1.940	5/16	4.910	.250	22° Flo. Ray Barton
F1501P	E	1.945	5/16	4.865	.200	22° Flo. Radial Groove
F1539P	E	1.945	5/16	5.029	.250	22° Flo. Radial Groove
F1512P	I	2.250	5/16	5.422	.200	24° Flo. Radial Groove. Ray Barton
F1500P	I	2.250	5/16	5.472	.250	24° Flo
F2275P	I	2.250	5/16	5.522	.250	24° Super Flo. Radial Groove. Lightweight
F1538P	I	2.250	5/16	5.522	.250	24° Flo. Radial Groove
F2422P	I	2.320	5/16	5.485	.250	24° Flo. Radial Groove. Lightweight. Edelbrock
F1895P	I	2.350	5/16	5.472	.250	24° Flo
CHRYSLER HEMI - DART/BAE/AJR HEADS (11/32)						
F1526P	E	1.900	11/32	5.019	.250	22° Flo-DART/55° Seat-Turbo/T Fuel/Funny Car-Hi Temp (Super Alloy)
F1527P	E	1.950	11/32	5.019	.250	22° Flo-DART/BAE/AJR-50° Seat-Turbo/T Fuel/Funny Car-Hi Temp (Super Alloy) Requires Lash Caps
F1535P	E	1.950	11/32	5.019	.250	22° Flo-55° Seat. T/F-F/C (Super Alloy)
F1505P	E	2.000	11/32	5.019	.250	22° Flo-45° Seat-DART/BAE AJR Heads
F1506P	E	2.000	11/32	5.019	.250	22° Flo-DART/BAE/AJR-45° Seat-Turbo/T Fuel/Funny Car-Hi Temp (Super Alloy)

COMPETITION PLUS VALVES

Part#	Type	Head Diam.	Stem Diam.	Overall Length	Tip Length	References
CHRYSLER HEMI - DART/BAE/AJR HEADS (3/8)						
F1531P	E	1.900	3/8	5.019	.250	22° Flo-55° Seat. T/F-F/C (Super Alloy)
F1533P	E	1.900	3/8	5.119	.250	22° Flo-55° Seat. T/F-F/C (Super Alloy)
F1537P	E	1.925	3/8	4.990	.250	22° Flo. 55° Seat. - Super Alloy. T/F - F/C
F2158P	E	1.925	3/8	5.019	.250	22° Flo. 55° Seat. 38° Backcut. - Super Alloy. T/F - F/C
F1536P	E	1.925	3/8	5.119	.250	22° Flo. 55° Seat / 38° Backcut. Sup. Alloy. T/F-F/C
F1571P	E	1.925	3/8	5.119	.250	22° Flo. 55° Seat. Radial Groove. Sup Alloy. T/F-F/C
F1532P	E	1.950	3/8	5.019	.250	22° Flo-55° Seat. T/F-F/C (Super Alloy)
F1570P	E	1.950	3/8	5.019	.250	22° Flo. 55° Seat. Radial Groove. Sup Alloy. T/F-F/C
F1529P	E	1.950	3/8	5.119	.250	22° Flo-50° Seat. (Super Alloy) - Funny Car/Top Fuel
F1534P	E	1.950	3/8	5.119	.250	22° Flo-55° Seat. T/F-F/C (Super Alloy)
F1507P	E	2.000	3/8	5.019	.250	22° Flo. (Super Alloy). Funny Car/Top Fuel
F1528P	E	2.000	3/8	5.119	.250	22° Flo-DART/55° Seat-Turbo/T Fuel/Funny Car-Hi Temp (Super Alloy)
DODGE VIPER 8.4L V10 - GEN 4 & 5 - 2013-2017						
F2407P	E	1.610	.313	5.575	.125	24° Super Flo. Stock. Special Alloy
F2408P	I	2.080	.3135	5.535	.125	12° Super Flo. Stock..
FORD ECOBOOST 2.3L - DOHC 16 VALVE - 2015						
F2370P	E	30mm	5.46mm	104.75mm	3.75mm	25° Taper Flo. Stock. Super Alloy
F2371P	E	30.5mm	5.46mm	104.75mm	3.75mm	25° Taper Flo. +.5mm Oversize. Super Alloy
F2374P	I	32.5mm	5.47mm	103.55mm	4 mm	22° Super Flo. Stock.
F2375P	I	33mm	5.47mm	103.55mm	4mm	22° Super Flo. +.5mm Oversize.
FORD ECOBOOST 3.5L - DOHC 24 VALVE - 2010-2016						
F2399P	E	31mm	5.47mm	95.40mm	3.8mm	22° Taper Flo. Stock. Super Alloy Turbo
F2400P	E	32mm	5.47mm	95.40mm	3.8mm	22° Taper Flo. +1mm Oversize. Super Alloy Turbo
F2401P	I	37mm	5.48mm	97.65mm	3.8mm	19° Super Flo. Stock. Special Alloy
F2402P	I	38mm	5.48mm	97.65mm	3.8mm	19° Super Flo. +1mm Oversize. Special Alloy
FORD 4.6 - 16 VALVES						
F2198P	E	1.450	.274	4.656	.466	14° Taper Flo. 3 Radial Grooves. Stock. Super Alloy
F2199P	I	1.780	.274	4.712	.466	12° Super Flo. 3 Radial Grooves. Stock.
FORD 4.6L/5.4L - SOHC V8 - 24 VALVES 2005-2007						
F1188P	E	1.474	.235	4.580	.472	21° Flo. Stk. size. Super Alloy. Single Groove. 1 Valve required
F1189P	E	1.553	.235	4.580	.472	21° Flo. oversize. Super Alloy. Single Groove. 1 Valve required
F1198P	I	1.332	.235	4.617	.406	19° Super Flo. Stk. size. Single Groove. 2 Valve required
F1199P	I	1.372	.235	4.617	.406	19° Super Flo. oversize. Single Groove. 2 Valve required
Tech Note: These Ferrea Valves come with single radial groove. These valves required Ferrea Valve Spring #S10102, Ferrea Titanium Retainer #E11069 and both Ferrea Spring Seat Locator #SL1055 and Factory supply Spring Seat Locator and Ferrea Valve Lock #K10077. For racing applications Ferrea Racing does not recommend the use of triple radial groove valves.						
FORD 4.6 - 32 VALVES						
F1450P	I	37mm	7mm	135.6mm	15.7mm	20° Stock. 3 Radial Groove
F1451P	E	30mm	7mm	116.3mm	10.65mm	25° Stock. 3 Radial Groove
FORD COYOTE 5.0L - DOHC 32 VALVE - 2010-2014						
F2244P	E	1.222	.2346	4.275	.300	25° Taper Flo. 3 Radial Groove. Stock. Super Alloy
F2245P	E	1.262	.2346	4.275	.300	25° Taper Flo. 3 Radial Groove. Oversize. Super Alloy
F2242P	I	1.460	.2358	4.720	.360	12° Super Flo. 3 Radial Groove. Stock. Special Alloy.
F2243P	I	1.500	.2358	4.720	.360	12° Super Flo. 3 Radial Groove. Oversize. Special Alloy.
FORD COYOTE 5.0L - DOHC 32 VALVES - 2015-2017						
F2383P	E	1.250	.235	4.275	.300	20° Taper Flo. 3 Radial Groove. Stock. Super Alloy. 45° Seat
F2382P	I	1.470	.236	4.720	.360	12° Super Flo. 3 Radial Groove. Stock. Special Alloy
FORD COYOTE 5.0L - DOHC 32 VALVES - 2018-2019						
F2423P	E	1.260	.2345	4.315	.280	21° Taper Flo. 3 Radial Groove. Stock. Super Alloy
F2424P	E	1.300	.2345	4.315	.280	21° Taper Flo. 3 Radial Groove. +1mm Oversize. Super Alloy
F2425P	E	1.260	.2345	4.315	.280	21° Taper Flo. 3 Radial Groove. Stock. Super Alloy. 40° Seat
F2426P	I	1.485	.2355	4.750	.310	12° Super Flo. 3 Radial Groove. Stock
F2427P	I	1.525	.2355	4.750	.310	12° Super Flo. 3 Radial Groove. +1mm Oversize
FORD VOODOO 5.2L - DOHC 32 VALVE (GT350) - 2015-2017						
F2403P	E	1.280	.2345	4.325	.250	21° Taper Flo. 3 Radial Groove. Stock. Super Alloy
F2409P	E	1.280	.2345	4.325	.250	21° Taper Flo. 3 Radial Groove. Stock. Super Alloy. 40° Seat
F2404P	E	1.320	.2345	4.325	.250	21° Taper Flo. 3 Radial Groove. +1mm Oversize. Super Alloy
F2405P	I	1.510	.2355	4.765	.310	12° Super Flo. 3 Radial Groove. Stock.
F2406P	I	1.550	.2355	4.765	.310	12° Super Flo. 3 Radial Groove. +1mm Oversize.
FORD 429 - 460 W/AFTERMARKET HEADS						
F2222P	E	1.880	11/32	5.700	.250	15° Super Flo-SVO/TFS
F2269P	E	1.940	11/32	5.700	.250	15° Super Flo-SVO/TFS
F2221P	I	2.300	11/32	5.755	.250	12° Super Flo-SVO/TFS
F2268P	I	2.350	11/32	5.755	.250	12° Super Flo-SVO/TFS
FORD BOSS 302 - 351 C - 429 - 460 (5/16)						
F1134P	E	1.650	5/16	5.010	.250	12° Flo-Hi Temp S.Alloy-Inconel
F1151P	E	1.650	5/16	5.058	.250	10° Flo
F1242P	I	2.125	5/16	5.275	.250	12° Flo
F1244P	I	2.250	5/16	5.325	.250	12° Flo

DOMESTIC APPLICATIONS

COMPETITION PLUS VALVES

Part#	Type	Head Diam.	Stem Diam.	Overall Length	Tip Length	References
FORD BOSS 302 - 351 C - 429 - 460 (11/32)						
F1420P	E	1.650	11/32	5.058	.250	12° Super Flo-351C/429/460
F1440P	E	1.655	11/32	5.165	.250	14° Super Flo-Ford 351. +.100
F1400P	E	1.710	11/32	5.058	.250	14° Super Flo-351C/429/460
F1441P	E	1.710	11/32	5.165	.250	14° Super Flo-Ford 351. +.100
F1437P	E	1.760	11/32	5.058	.250	14° Super Flo-429/460
F1439P	E	1.770	11/32	5.165	.250	14° Super Flo-Ford 429/460. +.100
F1401P	E	1.800	11/32	5.058	.250	14° Super Flo-429CJ-Bluethunder Head
F1170P	E	1.800	11/32	5.160	.250	12° Super Flo. +.100
F1171P	E	1.880	11/32	5.058	.250	14° Super Flo-Bluethunder Head
F1211P	I	2.190	11/32	5.300	.250	12° SupFlo-351C/429/460-Bluethu Head
F1226P	I	2.190	11/32	5.346	.250	12° Super Flo-Ford 351/429/460. +.100
F1212P	I	2.250	11/32	5.300	.250	12° SupFlo-351C/429CJ-Bluethu Head
FORD FE 352 - 390 - 427 - 428 W/AFTERMARKET HEADS						
F2223P	E	1.650	11/32	5.450	.250	15° Super Flo. Special Alloy. Blue Thunder
F2224P	E	1.710	11/32	5.450	.250	15° Super Flo. Special Alloy. Blue Thunder
FORD GT 500 5.4L - 32 VALVE - 2005-2007						
F2164P	E	1.260	.275	4.635	.390	15° Flo. Super Alloy. 3 Radial Groove. Stock
F2165P	I	1.455	.2755	5.395	.455	12° Flo. Super Flo. Special Alloy. 3 Radial Groove. Stock
FORD SVO C 460 (MOTORSPORT HEAD)						
F1264P	E	1.900	11/32	6.240	.300	15° Flo
F1236P	I	2.425	11/32	6.300	.300	12° Super Flo
PONTIAC (PRO STOCK)						
F1263P	E	1.900	11/32	6.450	.250	22° Flo
F1265P	I	2.400	11/32	6.600	.250	12° Flo
PONTIAC BIG BLOCK (KAUFFMAN AFTERMARKET HEAD)						
F1249P	E	1.700	11/32	6.200	.250	24° Super Flo. Dish Head. (KRE High Port Head)
F1251P	E	1.750	11/32	6.200	.250	24° Super Flo. Dish Head. (KRE High Port Head)
F1250P	I	2.200	11/32	6.200	.250	12° Super Flo. Dish Head. (KRE High Port Head)

COMPETITION PLUS VALVES - BLANKS

Part#	Type	Head Diam.	Stem Diam.	Overall Length	Tip Length	References
BLANKS (5/16) ("REQUIRE LASH CAPS or HARD TIPS")						
F1475P	E	1.650	5/16	6.600	BLANK	12° Super Flo. Dish Head. (Super Alloy)
F1487P	E	1.650	5/16	7.000	BLANK	24° Tulip Flo. Dish Head. Super Alloy
F2339P	E	1.650	.311	7.000	BLANK	24° Flo.Tulip.Hi Temp Special Alloy
F1177P	E	1.650	5/16	7.500	BLANK	12° Flo. Hi Temp Special Alloy
F2334P	E	1.650	.311	7.500	BLANK	12° Flo. Hi Temp Special Alloy
F1197P	E	1.800	5/16	7.000	BLANK	24° Flo. Tulip. HiTe.Finished. No groove. Spec. Alloy
F2354P	E	1.800	5/16	7.000	BLANK	24° Tulip Flo. Dish Head. Super Alloy
F2335P	E	1.800	.311	7.000	BLANK	24° Flo. Tulip. Hi Temp Special Alloy
F1233P	E	1.950	5/16	6.500	BLANK	15° Flo. Finished.No groove. Special Alloy
F1237P	E	2.000	5/16	7.000	BLANK	22° Flo. Tulip Flo - Finished No groove. Spec. Alloy
F2336P	E	2.000	.311	7.000	BLANK	22° Flo. Tulip. Hi Temp Special Alloy
F2392P	E	2.000	5/16	7.000	BLANK	22° Tulip Flo. Finished. No groove. Super Alloy
F1248P	I	2.020	5/16	7.000	BLANK	12° Flo. Dish Head. No groove.
F1245P	I	2.125	5/16	7.000	BLANK	12° Flo. Finished. No groove. Spec. Alloy
F1246P	I	2.150	5/16	7.000	BLANK	12° Flo. Finished. No groove. Spec. Alloy
F2337P	I	2.150	.311	7.000	BLANK	12° Flo.
F1247P	I	2.250	5/16	7.000	BLANK	12° Super Flo. Finished. No groove. Spec. Alloy
F1510P	I	2.300	5/16	7.000	BLANK	24° Tulip Flo.Finished.No groove. Special Alloy
F1243P	I	2.350	5/16	7.000	BLANK	12° Super Flo. Finished.No groove. Spec. Alloy
F2338P	I	2.350	.311	7.000	BLANK	12° Flo.No groove. Spec. Alloy
BLANKS (11/32) ("REQUIRE LASH CAPS or HARD TIPS")						
F2310P	E	1.600	11/32	7.000	BLANK	14° Super Flo. Special Alloy
F2311P	E	1.600	11/32	7.000	BLANK	24° Flo. Tulip. Special Alloy
F1888P	E	1.625	11/32	7.000	BLANK	24° Super Flo. Special Alloy
F2312P	E	1.625	11/32	7.000	BLANK	14° Super Flo. Special Alloy
F1590P	E	1.650	11/32	7.000	BLANK	23.5° Tulip Flo. Dish Head. Super Alloy
F1184P	E	1.650	11/32	7.500	BLANK	15° Super Flo. HiTe Alloy. Finished.No groove
F1889P	E	1.650	11/32	7.000	BLANK	24° Flo. Special Alloy
F1196P	E	1.800	11/32	7.000	BLANK	24° Super Flo. Tulip.HiTe Special Alloy
F1589P	E	1.800	11/32	7.000	BLANK	23.5 Tulip Flo. Dish Head. Super Alloy
F1591P	E	1.800	11/32	7.000	BLANK	15° Super Flo. Special Alloy
F2346P	E	1.900	11/32	7.000	BLANK	15° Super Flo. Special Alloy
F2347P	E	1.940	11/32	7.000	BLANK	22.5° Tulip Taper Flo. Dish Head. Super Alloy
F1181P	E	2.000	11/32	7.000	BLANK	15° Super Flo. Flat Head. Finished.No groove
F1183P	E	2.000	11/32	7.000	BLANK	15° Super Flo. Finished.No groove
F1509P	E	2.000	11/32	7.000	BLANK	23.5° Tulip Taper Flo. Dish Head. Super Alloy
F2348P	E	2.000	11/32	7.500	BLANK	15° Flo. Flat Head. Super Alloy
F2349P	I	2.100	11/32	7.000	BLANK	12° Super Flo. Special Alloy
F2350P	I	2.125	11/32	7.000	BLANK	12° Super Flo. Special Alloy
F1890P	I	2.150	11/32	7.000	BLANK	12° Super Flo. Special Alloy
F1891P	I	2.200	11/32	7.000	BLANK	12° Flo. Special Alloy
F2351P	I	2.250	11/32	7.000	BLANK	12° Super Flo. Special Alloy

COMPETITION PLUS VALVES - BLANKS

Part#	Type	Head Diam.	Stem Diam.	Overall Length	Tip Length	References
BLANKS (11/32) ("REQUIRE LASH CAPS or HARD TIPS")						
F2352P	I	2.300	11/32	7.000	BLANK	12° Super Flo. Special Alloy
F2309P	I	2.300	11/32	7.500	BLANK	12° Super Flo. Special Alloy
F2353P	I	2.350	11/32	7.000	BLANK	12° Super Flo. Special Alloy
F1190P	I	2.375	11/32	7.000	BLANK	12° Super Flo. Finished.No groove. Special Alloy
F1191P	I	2.375	11/32	7.000	BLANK	12° S. Flo. Flat Head.Finished.No groove. Spec. Alloy
F2196P	I	2.375	11/32	7.000	BLANK	12° S. Flo. Flat Head. Finished. No groove
F1193P	I	2.600	11/32	7.000	BLANK	12° Super Flo. Finished. No groove. Special Alloy
BLANKS (3/8) ("REQUIRE LASH CAPS or HARD TIPS")						
F2385P	E	1.800	3/8	7.500	BLANK	22° Tulip Taper Flo. 50° Seat. Flat Head. Super Alloy
F1572P	E	1.925	3/8	5.219	BLANK	22.5° Tulip Flo. Dish Head. Super Alloy
F1594P	E	1.940	3/8	7.000	BLANK	15° Super Flo. Special Alloy
F1530P	E	1.950	3/8	5.170	BLANK	22° Flo-DART/55° Seat-Turbo/T Fuel/Funny Car-Hi Temp (Super Alloy)
F2372P	E	2.000	3/8	7.500	BLANK	22° Flo. 45° Seat. Flat Head. Super Alloy
F2384P	E	2.000	3/8	7.500	BLANK	22° Tulip Taper Flo. 50° Seat. Flat Head. Super Alloy
F1511P	E	2.100	3/8	7.000	BLANK	22° Tulip Flo. Dish Head. Super Alloy
F2229P	E	2.250	3/8	7.500	BLANK	22° Tulip Taper Flo. 50° Seat. Flat Head. Super Alloy
F1592P	I	2.350	3/8	7.000	BLANK	12° Super Flo.
F1593P	I	2.375	3/8	7.000	BLANK	12° Super Flo. Special Alloy. Flat Head
F2373P	I	2.500	3/8	7.500	BLANK	12° Flo. Flat Head. Special Alloy
BLANKS 4-5 mm ("REQUIRE LASH CAPS or HARD TIPS")						
F0066	E	23 mm	4 mm	125 mm	BLANK	21° Flo-No Groove-No Tip. Special Alloy
F0064	E/I	26.5 mm	4 mm	125 mm	BLANK	21° Flo-No Groove-No Tip. Special Alloy
F0232	I	30 mm	4 mm	135 mm	BLANK	21° Super Flo. Special Alloy
F0173	E	28.5 mm	4.46 mm	120 mm	BLANK	12° Flo-No Groove-No Tip. Special Alloy
F0171	E/I	31 mm	4.48 mm	120 mm	BLANK	12° Taper Flo Bimetallic. Special Alloy
F0172	I	31 mm	4.48 mm	120 mm	BLANK	15° Taper Flo Bimetallic. Special Alloy
F0062	I	34 mm	4.48 mm	125 mm	BLANK	19° Flo-No Groove-No Tip. Special Alloy
F0063	E	26 mm	4.5 mm	125 mm	BLANK	21° Flo-No Groove-No Tip. Special Alloy
F0183	E	29 mm	4.95 mm	130 mm	BLANK	12° Taper Flo. Special Alloy
F0337	E	27 mm	4.97 mm	135 mm	BLANK	19° Flo. Special Alloy. Bi-Metallic
F0067	I	30 mm	4.97 mm	135 mm	BLANK	19° Flo-No Groove-No Tip. Special Alloy
F0069	E	34 mm	4.97 mm	140 mm	BLANK	19° Flo. Super Alloy.
F0184	I	34 mm	4.97 mm	130 mm	BLANK	12° Flo. Special Alloy
F0362	I	36 mm	4.97 mm	135 mm	BLANK	12° Flo. Special Alloy
F0065	E/I	38 mm	4.97 mm	135 mm	BLANK	19° Flo-No Groove-No Tip. Special Alloy
F0338	I	32.1 mm	4.98 mm	135 mm	BLANK	19° SuperFlo. Dish Head
F0514	I	35mm	4.98mm	145mm	BLANK	20° Flo. Dish Head. Hardenable Seat
BLANKS 5-6 mm ("REQUIRE LASH CAPS or HARD TIPS")						
F2415P	E	32 mm	5.46 mm	145 mm	BLANK	25° Taper Flo. Super Alloy
F0242	E	34 mm	5.48 mm	145 mm	BLANK	15° Taper Flo. Flat Head. Special Alloy
F1943P	E	32 mm	5.48 mm	140 mm	BLANK	22° Flo. Super Alloy Turbo Applications
F1459P	E	32 mm	5.48 mm	135 mm	BLANK	22° Flo. Super Alloy
F1457P	I	37 mm	5.48 mm	145 mm	BLANK	20° Flo. Special Alloy
F0241	I	41 mm	5.48 mm	135 mm	BLANK	14° Super Flo. Flat Head. Special Alloy
F0047	I	34 mm	5.5 mm	135 mm	BLANK	19° Super Flo-No Groove-No Tip. Special Alloy
F0253	I	42 mm	5.5 mm	135 mm	BLANK	19° Super Flo. Special Alloy
F1492P	E	34 mm	5.95 mm	140 mm	BLANK	21° Tulip Flo. Bimetallic Super Alloy
F1942P	E	34 mm	5.95 mm	140 mm	BLANK	21° Flo. Super Alloy Turbo Applications
F0176	E	36 mm	5.95 mm	135 mm	BLANK	21° Flo. Special Alloy
F2416P	I	37 mm	5.47 mm	145 mm	BLANK	24° Super Flo. Special Alloy
F0175	E	36 mm	5.96 mm	135 mm	BLANK	21° Super Flo-No Groove-No Tip. Special Alloy
F1580P	I	36 mm	5.97 mm	145 mm	BLANK	12° Super Flo-No Groove-No Tip. Special Alloy
F1581P	I	38 mm	5.97 mm	145 mm	BLANK	15° Super Flo-No Groove-No Tip. Special Alloy
F0174	I	42 mm	5.97 mm	135 mm	BLANK	19° Super Flo-No Groove-No Tip. Special Alloy
F0293	I	46 mm	5.97 mm	145 mm	BLANK	19° Super Flo. Special Alloy.
F1582P	I	46 mm	5.97 mm	145 mm	BLANK	12° Super Flo-No Groove-No Tip.
F1996P	E	38 mm	5.975mm	150 mm	BLANK	21° Tulip Taper Flo. Dish Head. Super Alloy
BLANKS 6-7 mm ("REQUIRE LASH CAPS or HARD TIPS")						
F0060	I	40 mm	6 mm	145 mm	BLANK	19° Super Flo-No Groove-No Tip. Special Alloy
F1595P	E	31 mm	6.02 mm	145 mm	BLANK	25° Flo. Special Alloy. Ford
F1596P	I	36 mm	6.03 mm	145 mm	BLANK	19° Super Flo. Ford
F1455P	E	32.5 mm	6.55 mm	135 mm	BLANK	22° Flo Super Alloy
F1941P	E	32.5 mm	6.55 mm	140 mm	BLANK	22° Flo Super Alloy Turbo Applications
F1453P	E	36 mm	6.57 mm	145 mm	BLANK	20° Super Flo. Special Alloy
F1438P	I	38 mm	6.58 mm	135 mm	BLANK	20° Super Flo
F1585P	E	34 mm	6.95 mm	145 mm	BLANK	15° Flo. No grove-No Tip. Special Alloy
F0004	E	32.95 mm	6.97 mm	135 mm	BLANK	22° Flo-No Groove-No Tip. Special Alloy
F0034	E	36 mm	6.97 mm	145 mm	BLANK	22° Flo-No Groove-No Tip. Special Alloy
F0038	E	39 mm	6.97 mm	145 mm	BLANK	22° Tulip Flo-No Groove-No Tip. Special Alloy
F1586P	I	39 mm	6.97 mm	145 mm	BLANK	12° Super Flo. No Groove-No Tip. Special Alloy
F0002	I	41.95 mm	6.97 mm	135 mm	BLANK	20° Flo-No Groove-No Tip. Special Alloy
F1419P	E	34.5 mm	6.98 mm	135 mm	BLANK	30° Flo. Special Alloy
F1418P	I	40 mm	6.98 mm	135 mm	BLANK	20° Super Flo. Special Alloy
F0077	E	1.750	.275	5.710	BLANK	24° Tulip Flo. Special Alloy Harley Davidson
F0078	I	2.100	.275	5.710	BLANK	24° Tulip Flo. Harley Davidson
BLANKS (7 mm) ("REQUIRE LASH CAPS or HARD TIPS")						
F1472P	E	1.625	7mm	6.300	BLANK	12° Taper Flo. Dish Head. Super Alloy
F1493P	E	1.650	7mm	6.300	BLANK	24° Tulip Flo. Dish Head. Super Alloy
F2208P	I	2.150	7mm	6.500	BLANK	12° Flo. Ultra Light. Special Alloy
F2209P	I	2.250	7mm	6.500	BLANK	12° Flo. Ultra Light. Special Alloy

COMPETITION PLUS VALVES - BLANKS

Part#	Type	Head Diam.	Stem Diam.	Overall Length	Tip Length	References
BLANKS (7-8 mm) ("REQUIRE LASH CAPS or HARD TIPS")						
F0345	E	33 mm	7mm	145mm	BLANK	22.5° Tulip Flo. Super Alloy
F0346	E	39 mm	7mm	145mm	BLANK	22.5° Tulip Flo. Dish Head. Super Alloy
F0039	I	46 mm	7mm	145 mm	BLANK	12° Flo-No Groove-No Tip. Special Alloy
F2162P	E	32 mm	7.09mm	145mm	BLANK	R. 12mm Flo. Flat Head
F2163P	I	38 mm	7.01mm	145mm	BLANK	19° Super Flo. Flat Head
F2376P	I	38mm	7.10mm	145mm	BLANK	19° Super Flo. Flat Head. Special Alloy
F1583P	E	1.650	.313	6.000	BLANK	15° Super Flo. Special Alloy. GM LS7/L92
F2159P	E	1.650	.313	8.000	BLANK	15° Flo. Super Alloy. GM LS1/LS7/L92
F1584P	E	1.650	.313	6.000	BLANK	24° Super Flo. Special Alloy. GM LS7/L92
F1599P	E	1.650	.313	6.000	BLANK	24° Tulip Flo. Dish Head. Super Alloy. GM LS1/LS7/L92
F0230	E	41 mm	7.96mm	135 mm	BLANK	20° Super Flo. ducati. Special Alloy
F2172P	E	1.800	.3135	7.000	BLANK	4° Taper Flo. Flat Head. Super Alloy
F2173P	I	1.850	.3135	7.000	BLANK	6° Super Flo. Flat Head. No groove. Special Alloy
F1587P	I	2.000	.3135	6.000	BLANK	12° Super Flo. GM LS1/LS6
F1588P	I	2.200	.3135	6.000	BLANK	12° Super Flo. GM LS7/L92
F2398P	I	2.300	.3135	7.000	BLANK	12° Super Flo. GM LS7/L92
F2393P	I	2.400	.313	7.500	BLANK	24° Tulip Flo. Finished . No groove. Spec. Alloy
F0229	I	47 mm	7.98mm	135 mm	BLANK	20° Super Flo. ducati. Special Alloy
F1442P	I	44 mm	8mm	110 mm	8.5 mm	10° Super Flo. Special Alloy

BLANKS 9 mm ("REQUIRE LASH CAPS or HARD TIPS")

F2332P	E	47mm	8.96mm	178mm	BLANK	25° Taper Flo. Special Alloy. Porsche
F2363P	E	47mm	8.96mm	178mm	BLANK	25° Flo. Flat Head. Special Alloy. Porsche
F2333P	I	53mm	8.98mm	178mm	BLANK	12° Super Flo. Flat Head. Porsche.
F2364P	I	53mm	8.98mm	178mm	BLANK	18° Flo. Flat Head. Porsche
F2307P	I	56mm	8.98mm	178mm	BLANK	10° Super Flo. Flat Head. Porsche
F2362P	I	56mm	8.98mm	178mm	BLANK	10° Flo. Flat Head. Porsche

6000 SERIES COMPETITION VALVES

Part#	Type	Head Diam.	Stem Diam.	Overall Length	Tip Length	References
-------	------	------------	------------	----------------	------------	------------

BUICK V-6 (11/32)

F6237	E	1.500	11/32	4.735	.254	29° Tulip Flo-Stage 1&2 Iron Head
F6238	I	1.775	11/32	4.735	.271	10° Super Flo-Stage 1&2 Iron Head

CHEVROLET BIG BLOCK (11/32)

F6296	E	1.880	11/32	5.350	.250	15° Super Flo. Stk
F6157	E	1.880	11/32	5.425	.250	15° Super Flo. Brodix/Dart 320-360. +.100
F6184	E	1.880	11/32	5.471	.250	15° Super Flo. +.150
F6186	E	1.900	11/32	5.425	.250	15° Super Flo. +.100
F6158	E	1.940	11/32	5.425	.250	15° Super Flo. +.100
F6297	I	2.190	11/32	5.221	.250	12° Super Flo. Stk
F6139	I	2.190	11/32	5.275	.250	12° Super Flo. +.050
F6189	I	2.190	11/32	5.344	.250	12° Super Flo. +.100
F6269	I	2.190	11/32	5.471	.250	12° Super Flo. +.250.
F6196	I	2.200	11/32	5.271	.250	12° Super Flo. +.050
F6298	I	2.250	11/32	5.221	.250	12° Super Flo. Stk
F6129	I	2.250	11/32	5.271	.250	12° Super Flo. Stk/+.050
F6190	I	2.250	11/32	5.344	.250	12° Super Flo. +.100
F6195	I	2.250	11/32	5.471	.250	12° Super Flo. +.250
F6130	I	2.300	11/32	5.321	.250	12° Super Flo. +.100
F6131	I	2.300	11/32	5.471	.250	12° Super Flo. Brodix/Dart 320-360. +.250
F6138	I	2.325	11/32	5.471	.250	12° Super Flo. Brodix/Dart 320-360. +.250

CHEVROLET BIG BLOCK (3/8)

F6128	E	1.725	3/8	5.350	.225	15° Super Flo. Stk
F6125	E	1.880	3/8	5.350	.225	15° Super Flo. Stk
F6156	E	1.880	3/8	5.400	.225	15° Super Flo. Brodix/Dart 320-360. +.050
F6185	E	1.890	3/8	5.425	.225	15° Super Flo. +.100
F6127	I	2.065	3/8	5.221	.225	12° Super Flo. Stk
F6126	I	2.190	3/8	5.221	.225	12° Super Flo. Stk
F6133	I	2.250	3/8	5.271	.225	12° Super Flo. +.050
F6134	I	2.300	3/8	5.321	.225	12° Super Flo. Brodix/Dart 320/360. +.100
F6135	I	2.300	3/8	5.421	.225	12° Super Flo. Brodix/Dart 320/360. +.200

CHEVROLET SMALL BLOCK (5/16)

F6315	E	1.600	5/16	5.010	.250	12° Flo. Radial Groove. +.100
F6316	E	1.600	5/16	5.060	.250	20° Flo. Radial Groove. +.150
F6317	E	1.625	5/16	5.010	.250	12° Flo. Radial Groove. +.100
F6318	E	1.625	5/16	5.060	.250	20° Flo. Radial Groove. +.150
F6319	I	2.020	5/16	5.010	.250	12° Flo. Radial Groove. +.100
F6320	I	2.020	5/16	5.060	.250	12° Flo. Radial Groove. +.150
F6321	I	2.055	5/16	5.010	.250	12° Flo. Radial Groove. +.100
F6322	I	2.055	5/16	5.060	.250	12° Flo. Radial Groove. +.150
F6323	I	2.080	5/16	5.010	.250	12° Flo. Radial Groove. +.100
F6324	I	2.080	5/16	5.060	.250	12° Flo. Radial Groove. +.150

6000 SERIES COMPETITION VALVES

Part#	Type	Head Diam.	Stem Diam.	Overall Length	Tip Length	References
CHEVROLET SMALL BLOCK (11/32)						
F6309	E	1.500	11/32	4.910	.250	12° Flo. Stk
F6107	E	1.500	11/32	4.960	.250	12° Flo. +.050
F6144	E	1.500	11/32	5.010	.250	12° Super Flo. +.100
F6308	E	1.550	11/32	4.910	.250	12° Flo. Stk
F6161	E	1.560	11/32	4.960	.250	12° Super Flo. +.050
F6305	E	1.600	11/32	4.910	.250	12° Flo. Stk
F6100	E	1.600	11/32	4.960	.250	12° Super Flo. +.050. (Edelbrock Head Stk)
F6108	E	1.600	11/32	4.960	.250	12° Flo. +.050
F6104	E	1.600	11/32	5.010	.250	12° Super Flo. +.100
F6145	E	1.600	11/32	5.010	.250	12° Flo. +.100
F6202	E	1.600	11/32	5.060	.250	20° Semi Tulip Super Flo. +.150
F6147	E	1.600	11/32	5.160	.250	12° Super Flo. +.250
F6160	E	1.600	11/32	5.300	.250	12° Super Flo-Brodix # 12. +.400
F6228	E	1.600	11/32	5.400	.250	12° Super Flo-Brodix # 12 & 18° +.500
F6143	E	1.625	11/32	4.960	.250	12° Super Flo. +.050
F6146	E	1.625	11/32	5.010	.250	12° Super Flo. +.100
F6205	E	1.625	11/32	5.060	.250	20° Semi Tulip Super Flo. +.150
F6148	E	1.625	11/32	5.160	.250	15° Super Flo-Brodix Pontiac. +.200
F6299	I	1.940	11/32	4.910	.250	10° Super Flo. Stk
F6102	I	1.940	11/32	4.960	.250	12° Super Flo. +.050
F6111	I	1.940	11/32	4.960	.250	12° Flo. +.050
F6300	I	1.940	11/32	4.960	.250	10° Super Flo. +.050
F6142	I	1.940	11/32	5.010	.250	12° Super Flo. +.100
F6301	I	1.940	11/32	5.010	.250	10° Super Flo. +.100
F6165	I	2.000	11/32	4.960	.250	12° Super Flo. +.050
F6302	I	2.020	11/32	4.910	.250	10° Super Flo. Stk
F6101	I	2.020	11/32	4.960	.250	12° Super Flo. +.050
F6110	I	2.020	11/32	4.960	.250	12° Flo. +.050
F6303	I	2.020	11/32	4.960	.250	10° Super Flo. +.050
F6103	I	2.020	11/32	5.010	.250	12° Super Flo. +.100
F6304	I	2.020	11/32	5.010	.250	10° Super Flo. +.100
F6208	I	2.020	11/32	5.060	.250	12° Super Flo. +.150
F6206	I	2.020	11/32	5.160	.250	12° Super Flo. Canfield Head. +.200
F6105	I	2.055	11/32	4.960	.250	12° Super Flo. +.050
F6114	I	2.055	11/32	5.010	.250	12° Super Flo. +.100
F6151	I	2.055	11/32	5.010	.250	12° Flo. +.100
F6207	I	2.055	11/32	5.060	.250	12° Super Flo. +.150
F6115	I	2.080	11/32	4.960	.250	12° Super Flo. +.050
F6116	I	2.080	11/32	5.010	.250	12° Super Flo. +.100
F6203	I	2.080	11/32	5.060	.250	12° Super Flo. +.150
F6164	I	2.080	11/32	5.160	.250	12° Super Flo. Canfield Head. +.200
F6263	I	2.080	11/32	5.300	.250	12° Super Flo. +.400
F6117	I	2.100	11/32	4.960	.250	12° Super Flo. +.050
F6118	I	2.100	11/32	5.010	.250	12° Super Flo. +.100
F6256	I	2.100	11/32	5.060	.250	12° Super Flo. +.150
F6152	I	2.100	11/32	5.160	.250	12° Super Flo-Brodix Pontiac. +.200
F6153	I	2.125	11/32	5.010	.250	12° Super Flo. +.100
F6204	I	2.125	11/32	5.060	.250	12° Super Flo. +.150
F6154	I	2.125	11/32	5.160	.250	12° Super Flo-Brodix Pontiac. +.200
F6254	I	2.125	11/32	5.300	.250	12° Super Flo. +.400
F6166	I	2.150	11/32	5.300	.250	12° Super Flo-Brodix # 12. +.400
F6167	I	2.150	11/32	5.400	.250	12° Super Flo-Brodix # 12 & 18°. +.500
CHEVROLET SMALL BLOCK - LS1						
F6232	E	1.550	.313	4.915	.160	15° Flo. Radius Groove - LS1 CORVETTE
F6271	E	1.570	.313	4.915	.160	24° Tulip Super Flo. Radius Groove
F6233	E	1.600	.313	4.915	.160	15° S Flo. Radius Groove - LS1 CORVETTE
F6235	E	1.600	.313	4.915	.160	24° Tulip Super Flo. Radius Groove. LS1 CORVETTE
F6267	E	1.600	.313	5.015	.160	24° Tulip Super Flo. +.100. Radius Groove
F6270	E	1.650	.313	4.915	.160	24° Tulip Super Flo. +.100. Radius Groove
F6230	I	2.000	.3135	4.900	.160	12° Flo. Radius Groove - LS1 CORVETTE
F6231	I	2.020	.3135	4.900	.160	12° S Flo. Radius Groove - LS1 CORVETTE
F6266	I	2.020	.3135	5.000	.160	12° Super Flo. +.100. Radius Groove
F6234	I	2.055	.3135	4.900	.160	12° Super Flo. Radius Groove. LS1 CORVETTE
F6236	I	2.080	.3135	4.900	.160	12° Super Flo. Radius Groove. LS1 CORVETTE
F6268	I	2.080	.3135	5.000	.160	12° Super Flo. +.100. Radius Groove
F6242	I	2.100	.3135	4.900	.160	12° Super Flo. Radius Groove. LS1 CORVETTE
CHEVROLET SMALL BLOCK - LS3						
F6233	E	1.600	.313	4.915	.160	15° S Flo. Radius Groove.
F6235	E	1.600	.313	4.915	.160	24° Tulip Super Flo. Radius Groove
F6279	I	2.165	.3135	4.900	.160	12° S Flo. Backcut 30° Radius Groove
F6280	I	2.200	.3135	4.900	.160	12° S Flo. Backcut 30° Radius Groove

DOMESTIC APPLICATIONS

6000 SERIES COMPETITION VALVES

Part#	Type	Head Diam.	Stem Diam.	Overall Length	Tip Length	References
CHEVROLET SMALL BLOCK - LS6						
F6265	E	1.550	.313	4.939	.180	24° Tulip S Flo. Radius Groove
F6264	I	2.000	.3135	4.890	.180	12° S Flo. Radius Groove
CHEVROLET SMALL BLOCK - L92						
F6233	E	1.600	.313	4.915	.160	15° S Flo. Radius Groove.
F6235	E	1.600	.313	4.915	.160	24° Tulip Super Flo. Radius Groove
F6279	I	2.165	.3135	4.900	.160	12° S Flo Backcut 30° Radius Groove
F6280	I	2.200	.3135	4.900	.160	12° S Flo Backcut 30° Radius Groove
CHRYSLER 318-340-360 (3/8)						
F6243	E	1.500	3/8	4.970	.225	15° Super Flo.
F6244	E	1.600	3/8	4.970	.225	15° Super Flo.
F6245	E	1.625	3/8	4.970	.225	15° Super Flo.
F6246	I	1.780	3/8	4.980	.225	12° Super Flo.
F6247	I	1.880	3/8	4.980	.225	12° Super Flo.
F6248	I	1.920	3/8	4.980	.225	12° Super Flo.
F6249	I	2.020	3/8	4.980	.225	12° Super Flo.
CHRYSLER 340 & W2 (3/8)						
F6173	E	1.600	3/8	5.075	.225	15° Super Flo. +.050
F6137	E	1.600	3/8	5.225	.225	15° Super Flo-W2
F6172	I	2.020	3/8	5.050	.225	11° Super Flo. +.050
F6136	I	2.080	3/8	5.225	.225	11° Super Flo-W2
CHRYSLER 440 CID (11/32) (INDY CYLINDER HEAD)						
F6188	E	1.810	11/32	5.369	.250	15° Super Flo
F6189	I	2.190	11/32	5.344	.250	12° Super Flo
F6190	I	2.250	11/32	5.344	.250	12° Super Flo
CHRYSLER 440 CID (11/32)						
F6306	E	1.810	11/32	4.930	.250	15° Super Flo-Edelbrock Head
F6307	I	2.140	11/32	4.910	.250	12° Super Flo-Edelbrock Head
CHRYSLER 440 CID (3/8)						
F6192	E	1.810	3/8	4.910	.290	15° Super Flo. Stk
F6250	E	1.880	3/8	4.910	.290	15° Super Flo
F6217	I	2.140	3/8	4.875	.290	12° Super Flo. Stk
F809525	I	2.175	3/8	4.875	.290	12° Flo. Stk
F6191	I	2.190	3/8	4.875	.290	12° Super Flo. Stk
CHRYSLER/DODGE HEMI 5.7L (2003-2008)						
F6198	E	1.550	.3125	4.845	.120	25° Flo. 3 Radial Grooves. Stock
F6199	I	2.000	.3125	4.955	.120	12° Super Flo. 3 Radial Grooves. Stock
FORD 2.0 L						
F6220	E	38.1mm	8mm	113mm	5.38mm	10° Flo
F6219	I	44.5mm	8.02mm	113mm	5.07mm	9° Flo
FORD ECOBOOST 2.3L - DOHC 16 VALVE - 2015						
F6343	E	30mm	5.46mm	104.75mm	3.75mm	25° Taper Flo. Stock. Special Alloy
F6344	I	32.5mm	5.47mm	103.55mm	4 mm	22° Super Flo. Stock.
FORD ECOBOOST 3.5L - DOHC 24 VALVE - 2010-2016						
F6359	E	31mm	5.47mm	95.40mm	3.8mm	22° Taper Flo. Stock. Special Alloy Turbo
F6360	I	37mm	5.48mm	97.65mm	3.8mm	19° Super Flo. Stock.
FORD 2.3 L						
F6224	E	1.500	11/32	4.800	.400	12° Super Flo
F6229	E	1.500	11/32	4.870	.470	12° Super Flo
F6222	E	1.590	11/32	4.800	.400	12° Super Flo
F6227	E	1.600	11/32	4.870	.470	12° Super Flo
F6223	I	1.740	11/32	4.800	.400	12° Super Flo
F6225	I	1.740	11/32	4.870	.470	12° Super Flo
F6221	I	1.890	11/32	4.800	.400	12° Super Flo
F6226	I	1.890	11/32	4.870	.470	12° Super Flo
FORD 4.6 - 16 VALVES						
F6274	E	1.450	.274	4.656	.466	14° Super Flo. 3 Radial Grooves. Stock
F6273	I	1.780	.274	4.712	.466	12° Super Flo. 3 Radial Grooves. Stock
FORD 4.6L/5.4L - SOHC 24 VALVES						
F6276	E	1.476	.2345	4.583	.380	25° Flo. 3 Radial Grooves. Stock. 1 Valve required
F6282	E	1.515	.2345	4.583	.380	25° Flo. 3 Radial Grooves. Oversize. 1 Valve required
F6281	I	1.331	.2355	4.618	.315	12° Flo. 3 Radial Grooves. Stock. 2 Valves required
F6283	I	1.378	.2355	4.618	.315	12° Flo. 3 Radial Grooves. Oversize. 2 Valves required

6000 SERIES COMPETITION VALVES

Part#	Type	Head Diam.	Stem Diam.	Overall Length	Tip Length	References
FORD 4.6 - 32 VALVES						
F6278	E	30 mm	7 mm	117.1 mm	10.65 mm	25° Super Flo. 3 Radial Grooves. Stock
F6277	I	37 mm	7 mm	135.9 mm	15.7 mm	20° Super Flo. 3 Radial Grooves. Stock
FORD COYOTE 5.0L - DOHC 32 VALVE - 2010-2014						
F6312	E	1.222	.2346	4.275	.300	25° Taper Flo. 3 Radial Groove. Stock. Special Alloy
F6314	E	1.262	.2346	4.275	.300	25° Taper Flo. 3 Radial Groove. Oversize. Special Alloy
F6310	I	1.460	.2358	4.720	.360	12° Super Flo. 3 Radial Groove. Stock.
F6311	I	1.500	.2358	4.720	.360	12° Super Flo. 3 Radial Groove. Oversize.
FORD COYOTE 5.0L - DOHC 32 VALVES - 2015-2017						
F6345	E	1.250	.235	4.275	.300	20° Taper Flo. 3 Radial Groove. Stock. Super Alloy
F6346	I	1.470	.236	4.720	.360	12° Super Flo. 3 Radial Groove. Stock. Special Alloy
FORD COYOTE 5.0L - DOHC 32 VALVES - 2018-2019						
F6366	E	1.260	0.2345	4.315	0.280	21° Taper Flo. 3 Radial Groove. Stock. Special Alloy. 40° Seat
F6367	E	1.300	0.2345	4.315	0.280	21° Taper Flo. 3 Radial Groove. +1mm Oversize. Special Alloy. 45° Seat
F6368	I	1.485	0.2355	4.750	0.310	12° Super Flo. 3 Radial Groove. Stock
F6369	I	1.525	0.2355	4.750	0.310	12° Super Flo. 3 Radial Groove. +1mm Oversize
FORD VOODOO 5.2L - DOHC 32 VALVE (GT350) - 2015-2017						
F6361	E	1.280	.2345	4.325	.250	21° Taper Flo. 3 Radial Groove. Stock. Special Alloy
F6362	E	1.340	.2345	4.325	.250	21° Taper Flo. 3 Radial Groove. +1mm Oversize. Special Alloy
F6363	I	1.510	.2355	4.765	.310	12° Super Flo. 3 Radial Groove. Stock.
F6364	I	1.550	.2355	4.765	.310	12° Super Flo. 3 Radial Groove. +1mm Oversize.
FORD 351 C (2 Barrel)						
F6179	E	1.650	11/32	5.060	.250	12° Super Flo. Stk
F6132	I	2.070	11/32	5.275	.250	12° Super Flo. Stk/+ .050
F6155	I	2.100	11/32	5.275	.250	12° Super Flo-SVO-Yates
FORD 351 N (SPORTSMAN HEAD)						
F6147	E	1.600	11/32	5.160	.250	12° Super Flo
F6206	I	2.020	11/32	5.160	.250	12° Super Flo
FORD 351 W & GT40 HEAD						
F6260	E	1.480	11/32	5.075	.395	14° Super Flo
F6123	E	1.550	11/32	5.075	.395	14° Super Flo. Stk
F6183	E	1.600	11/32	5.075	.395	14° Super Flo. Stk
F6261	I	1.780	11/32	5.075	.395	12° Super Flo
F6122	I	1.850	11/32	5.075	.395	12° Super Flo. Stk
F6239	I	1.900	11/32	5.075	.395	12° Super Flo. Stk. AFR/HOLLEY
F6170	I	1.940	11/32	5.075	.395	12° Super Flo. Stk
F6169	I	2.020	11/32	5.075	.395	12° Super Flo. Stk
FORD BOSS 302 - 351 C - 429 - 460						
F6124	E	1.710	11/32	5.060	.250	12° Super Flo-351C/429/ 460
F6258	E	1.760	11/32	5.060	.250	14° Super Flo
F6159	E	1.800	11/32	5.058	.250	12° Super Flo-SVO 429/460
F6209	E	1.800	11/32	5.060	.250	24° Tulip Super Flo. Stk
F6297	I	2.190	11/32	5.221	.250	12° Super Flo. Stk
F6139	I	2.190	11/32	5.275	.250	12° Super Flo-429/460. Stk/+ .050
F6189	I	2.190	11/32	5.344	.250	12° Super Flo-429/460. +.100
F6196	I	2.200	11/32	5.271	.250	12° Super Flo. 351C/429CJ. Stk/+ .050
F6129	I	2.250	11/32	5.271	.250	12° Super Flo-351C/429CJ. Stk/+ .050
F6190	I	2.250	11/32	5.344	.250	12° Super Flo-351C/429CJ. +.100
FORD FE 352 - 390 - 427 - 428 (11/32)						
F6339	E	1.665	11/32	5.435	.330	14° Super Flo.
F6340	E	1.760	11/32	5.435	.330	14° Super Flo.
F6341	I	2.200	11/32	5.450	.330	12° Super Flo. 30° Seat
F6342	I	2.200	11/32	5.450	.330	12° Super Flo. 45° Seat
FORD FE 352 - 390 - 427 - 428 (3/8)						
F6212	E	1.655	3/8	5.435	.330	12° Super Flo-Edelbrock Head
F6216	E	1.750	3/8	5.435	.330	12° Super Flo
F6210	I	2.090	3/8	5.450	.330	22° Super Flo 30° Seat-Edelbrock Head
F6211	I	2.150	3/8	5.450	.330	22° Super Flo 30° Seat
F6215	I	2.190	3/8	5.450	.330	22° Super Flo 30° Seat
F6214	I	2.250	3/8	5.450	.330	22° Super Flo 30° Seat
FORD WINDSOR 302 - 351						
F6100	E	1.600	11/32	4.960	.250	12° Super Flo. +.050. (Edelbrock Head Stk)
F6119	E	1.600	11/32	5.030	.325	14° Super Flo
F6218	I	1.900	11/32	4.960	.250	12° Super Flo-Edelbrock Head
F6193	I	1.900	11/32	5.030	.325	12° Super Flo-Edelbrock Head
F6120	I	1.940	11/32	5.030	.325	12° Super Flo
F6121	I	2.020	11/32	5.030	.325	12° Super Flo
PONTIAC 400 - 428 - 455						
F6259	E	1.660	11/32	5.110	.250	12° Super Flo
F6177	E	1.660	11/32	5.230	.250	12° Super Flo-Edelbrock Head
F6176	E	1.770	11/32	5.110	.250	12° Super Flo
F6178	E	1.770	11/32	5.230	.250	12° Super Flo-Edelbrock & RA IV Head
F6174	I	2.110	11/32	5.095	.250	12° Super Flo-45° Seat
F6175	I	2.110	11/32	5.213	.250	12° Super Flo-Edelbrock & RA IV Head-45° Seat

DOMESTIC APPLICATIONS

5000 SERIES HI PERFORMANCE VALVES

Part#	Type	Head Diam.	Stem Diam.	Overall Length	Tip Length	References
CHEVROLET BIG BLOCK (11/32)						
F5146	E	1.880	11/32	5.350	.250	15° Super Flo. Stk
F5035	E	1.880	11/32	5.425	.250	12° Under Cut-Dish Head. +.100
F5147	I	2.190	11/32	5.221	.250	12° Super Flo. Stk
F5037	I	2.190	11/32	5.300	.250	10° Under Cut-Dish Head. +.100
F5148	I	2.250	11/32	5.221	.250	12° Super Flo. Stk
F5031	I	2.250	11/32	5.271	.250	10° Under Cut-Dish Head. +.050
F5070	I	2.250	11/32	5.471	.250	10° Under Cut-Dish Head. +.250
CHEVROLET BIG BLOCK (3/8)						
F5010	E	1.725	3/8	5.350	.225	12° Under Cut-Dish Head. Stk
F5011	E	1.880	3/8	5.350	.225	12° Under Cut-Dish Head. Stk
F5111	E	1.880	3/8	5.375	.225	9° Flo-Flat Head. Stk
F5007	I	2.065	3/8	5.221	.225	10° Under Cut-Dish Head. Stk
F5008	I	2.190	3/8	5.221	.225	10° Under Cut-Dish Head. Stk
F5108	I	2.190	3/8	5.246	.225	9° Flo-Flat Head. Stk
F5009	I	2.250	3/8	5.271	.225	10° Under Cut-Dish Head. Stk
CHEVROLET SMALL BLOCK (11/32)						
F5004	E	1.500	11/32	4.910	.256	12° Under Cut-Dish Head. Stk
F5104	E	1.500	11/32	4.935	.250	9° Flo-Double Groove-Flat Head. Stk
F5049	E	1.500	11/32	5.010	.256	12° Under Cut. +.100
F5005	E	1.600	11/32	4.910	.256	12° Under Cut-Dish Head. Stk
F5105	E	1.600	11/32	4.935	.250	9° Flo-Double Groove-Flat Head. Stk
F5046	E	1.600	11/32	4.960	.250	15° Semi Tulip-Under Cut-Dish Head-TFS
F5025	E	1.600	11/32	5.010	.256	12° Under Cut-Dish Head. +.100
F5006	E	1.625	11/32	5.010	.256	12° Under Cut-Dish Head. +.100
F5040	E	1.650	11/32	5.060	.250	12° Under Cut-Dish Head. +.150
F5000	I	1.725	11/32	4.910	.256	10° Under Cut-Dish Head. Stk
F5060	I	1.840	11/32	4.910	.250	10° Under Cut-Dish Head
F5161	I	1.840	11/32	4.935	.250	9° Flo-Double Groove-Flat Head
F5072	I	1.900	11/32	4.910	.256	10° Under Cut-Dish Head. AFR/HOLLEY
F5001	I	1.940	11/32	4.910	.256	10° Under Cut-Dish Head. Stk
F5101	I	1.940	11/32	4.935	.250	9° Flo-Double Groove-Flat Head. Stk
F5048	I	1.940	11/32	5.010	.256	10° Under Cut. +.100
F5002	I	2.020	11/32	4.910	.256	10° Under Cut-Dish Head. Stk
F5102	I	2.020	11/32	4.935	.250	9° Flo-Double Groove-Flat Head. Stk
F5047	I	2.020	11/32	4.960	.250	10° Under Cut.TFS. Dish Head. +.050
F5027	I	2.020	11/32	5.010	.256	10° Under Cut-Dish Head. +.100
F5003	I	2.055	11/32	4.910	.256	10° Under Cut-Dish Head. Stk
F5103	I	2.055	11/32	4.935	.250	9° Flo-Double Groove-Flat Head. Stk
F5022	I	2.055	11/32	5.010	.256	10° Under Cut-Dish Head. +.100
F5021	I	2.080	11/32	4.910	.256	10° Under Cut-Dish Head. Stk
F5023	I	2.080	11/32	5.010	.256	10° Under Cut-Dish Head. +.100
CHRYSLER 340 & W2 (3/8)						
F5051	E	1.600	3/8	5.075	.225	14° Super Flo
F5050	I	2.020	3/8	5.050	.225	12° Super Flo
CHRYSLER 440 CID (3/8)						
F5055	E	1.740	3/8	4.910	.290	14° Super Flo
F5053	E	1.810	3/8	4.910	.290	14° Super Flo
F5054	I	2.080	3/8	4.875	.290	12° Super Flo
F5052	I	2.140	3/8	4.875	.290	12° Super Flo
FORD 351 C (2 Barrel)						
F5040	E	1.650	11/32	5.060	.250	12° Under Cut-Dish Head
F5026	I	2.070	11/32	5.275	.250	10° Under Cut-Dish Head
FORD 351 W & GT40 HEAD						
F5028	E	1.550	11/32	5.075	.395	12° Under Cut-Dish Head
F5058	E	1.600	11/32	5.075	.395	12° Under Cut-Dish Head
F5029	I	1.850	11/32	5.075	.395	10° Under Cut-Dish Head
F5071	I	1.900	11/32	5.075	.395	10° Under Cut-Dish Head. AFR/HOLLEY
F5059	I	1.940	11/32	5.075	.395	10° Under Cut-Dish Head
FORD BOSS 302 - 351 C - 429 - 460						
F5045	E	1.710	11/32	5.060	.250	12° Under Cut-Dish Head
F5145	E	1.760	11/32	5.060	.250	9° Flo-Dish Head
F5037	I	2.190	11/32	5.300	.250	10° Under Cut-Dish Head
F5031	I	2.250	11/32	5.271	.250	10° Under Cut-Dish Head

5000 SERIES HI PERFORMANCE VALVES

Part#	Type	Head Diam.	Stem Diam.	Overall Length	Tip Length	References
FORD WINDSOR 289 - 302 - 351						
F5014	E	1.450	11/32	5.030	.325	12° Under Cut-Dish Head
F5015	E	1.600	11/32	5.030	.325	12° Under Cut-Dish Head
F5012	I	1.782	11/32	5.030	.325	10° Under Cut-Dish Head
F5056	I	1.900	11/32	5.030	.325	10° Under Cut-Dish Head
F5018	I	1.940	11/32	5.030	.325	10° Under Cut-Dish Head
F5020	I	2.020	11/32	5.030	.325	10° Under Cut-Dish Head
F5039	I	2.055	11/32	5.060	.250	10° Under Cut-Dish Head
OLDSMOBILE						
F5141	E	1.710	11/32	4.668	.250	9° Flo-Dish Head
F5141B	E	1.710	11/32	4.735	.250	9° Flo-Dish Head
F5142	I	2.075	11/32	4.715	.250	9° Flo-Dish Head
PONTIAC 400 - 428 - 455						
F5080	E	1.660	11/32	4.980	.250	12° Under Cut - Dish Head.
F5079	E	1.660	11/32	5.110	.250	12° Under Cut - Dish Head. (KRE Alluminum D-Port)
F5064	E	1.660	11/32	5.230	.250	12° Under Cut-Dish Head-Edelbrock
F5062	E	1.770	11/32	4.980	.250	12° Under Cut-Dish Head
F5144	E	1.770	11/32	5.110	.250	9° Flo-Dish Head
F5063	E	1.770	11/32	5.230	.250	12° Under Cut-Dish Head-RA IV
F5082	I	2.110	11/32	4.980	.250	12° Under Cut-Dish Head-30° Seat
F5065	I	2.110	11/32	4.980	.250	12° Under Cut-Dish Head-45° Seat
F5143	I	2.110	11/32	5.095	.250	9° Flo-Dish Head-30° Seat
F5073	I	2.110	11/32	5.095	.250	9° Flo-Dish Head-45° Seat. (KRE Aluminum D-Port).
F5066	I	2.110	11/32	5.213	.250	12° Under Cut-Dish Head-30° Seat-RA IV/Edelbrock
F5074	I	2.110	11/32	5.213	.250	12° Under Cut-Dish Head-45° Seat RA IV/Edelbrock

LIFTERS

Part#	Specifications
CHRYSLER	
LF1004	Solid Lifter .904". Ultra lightweight
FORD	
LF1003	Solid Lifter .874". Ultra lightweight

(*) Additional wear resistant H-DLC coating can be applied to the lifter crown face at an extra charge. Please contact a Ferrea representative for pricing

ATTENTION ENGINE BUILDERS

Ferrea Racing Components **STRONGLY** recommends to check camshaft lobe taper before installation. The aftermarket camshaft taper standard is between .001"-.002" across the lobe. If lobe taper is less than .002" (minimum) it may cause premature camshaft failure. Please check with your camshaft manufacturer or grinder for more information.

BEEHIVE VALVE SPRINGS

Part#	Type/Material/ Application	O.D.	I.D.	Seat Press.	Open Press.	Rate Inch	Coil Bind	Max Net Lift
CHEVROLET BIG BLOCK								
S2003	Single Beehive. PAC Alloy Flat tappet or Hydraulic Roller	1.080 1.445	.650 1.000	155 lbs @1.880"	377 lbs @1.280"	370 lbs	1.210"	.600"
This Spring requires Ferrea Titanium Retainer #E12003 OR #E12006 and Ferrea Spring Seat Locator #SL1074 OR #SL1077								
S2004	Single Beehive. Ovate. PAC Alloy Nitrided High Lift Extreme Application	1.100 1.445	.650 1.000	155 lbs @1.880"	405 lbs @1.230"	370 lbs	1.180"	.650"
Features additional processing for Extreme application. This Spring requires Ferrea Titanium Retainer #E12003 OR #E12006 and Ferrea Spring Seat Locator #SL1074 OR #SL1077								
CHEVROLET SMALL BLOCK - LS1 / LT1								
S2000	Single Beehive. PAC Alloy Performance OEM replacement	1.050 1.290	.650 .885	105 lbs @1.800"	293 lbs @1.200"	313 lbs	1.140"	.600"
This Spring requires Ferrea Steel Retainer #E10029 OR Ferrea Titanium Retainer # E12014 and Ferrea Spring Seat Locator #SL1080								
S2001	Single Beehive. Ovate. PAC Alloy High Performance	1.050 1.290	.650 .885	130 lbs @1.800"	318 lbs @1.200"	313 lbs	1.140"	.600"
This Spring requires Ferrea Steel Retainer #E10029 OR Ferrea Titanium Retainer #E12014 and Ferrea Spring Seat Locator #SL1080								
S2002	Single Beehive. Ovate. PAC Alloy Nitrided High Lift Extreme Application	1.050 1.290	.650 .885	130 lbs @1.800"	337 lbs @1.150"	313 lbs	1.080"	.650"
Features additional processing for Extreme application. This Spring requires Ferrea Steel Retainer #E10029 OR Ferrea Titanium Retainer #E12014 and Ferrea Spring Seat Locator #SL1080								
CHRYSLER/DODGE HEMI 5.7L/6.1L								
S2009	Single Beehive Ovate. PAC Alloy Performance OEM replacment	1.035 1.210	.630 .805	135 lbs @1.800"	350 lbs @1.200"	358 lbs	1.160"	.600"
This Spring requires Ferrea Steel Retainer #E10031 OR Ferrea Titanium Retainer #E12008 and Ferrea Spring Seat Locator # SL1079								

BEEHIVE VALVE SPRINGS

Part#	Type/Material/ Application	O.D.	I.D.	Seat Press.	Open Press.	Rate Inch	Coil Bind	Max Net Lift
DODGE VIPER 8.4L V10 - GEN 4 & 5 - 2013-2017								
S2026	Single Beehive Ovate. PAC Alloy	1.100	.650	170 lbs	440 lbs	394 lbs	1.240"	.685"
	High Lift - Street and Strip Use	1.445	1.000	@ 1.965"	@ 1.280			
	Premium RPM Performance processing							
This Spring requires Ferrea Tool Steel Retainer #E20058 and BOTH, Ferrea Spring Seat Locator #SL1157 and SL1158 (Hat Seal) or Factory supplied Hat Seal Seat Locator.								
ENDURANCE HIGH LIFT								
S2006	Single Beehive Ovate. PAC Alloy	1.175	.731	180 lbs	450 lbs	313 lbs	1.130"	.750"
	High Lift application	1.589	1.135	@2.000"	@1.200"			
This Spring requires Ferrea Titanium Retainer #E12012 OR #E12023 and Ferrea Spring Seat Locator #SL1075								
FLAT TAPPET & HYDRAULIC ROLLER								
S2005	Single Beehive Ovate. PAC Alloy	1.165	.731	160 lbs	425 lbs	408 lbs	1.220"	.700"
	High Lift Extreme application	1.445	.990	@1.950"	@1.300"			
This Spring requires Ferrea Titanium Retainer #E12012 OR #E12023 and Ferrea Spring Seat Locator #SL1083								
FORD 4.6L - 16 VALVE								
S2010	Single Beehive Ovate. PAC Alloy	.950	.636	80 lbs	185 lbs	191 lbs	1.020"	.550"
	Performance OEM replacment	1.061	.738	@1.640"	@1.090"			
This Spring requires Ferrea Steel Retainer #E10033 OR Ferrea Titanium Retainer #E12005 and Ferrea Spring Seat Locator #SL1076 OR Factory Seat Locator								
S2011	Single Beehive Ovate. PAC Alloy	.985	.636	100 lbs	265 lbs	275 lbs	1.040"	.600"
	High Lift application	1.061	.698	@1.640"	@1.080"			
This Spring requires Ferrea Titanium Retainer #E12005 and Ferrea Spring Seat Locator # SL1076 OR Factory Seat Locator								
FORD 4.6L/5.4L - SOHC V8 - 24 VALVE - 2005-2007								
S2007	Single Beehive Ovate. PAC Alloy	.915	.567	105 lbs	270 lbs	300 lbs	1.060"	.550"
	Performance OEM replacement	1.025	.662	@1.670"	@1.120"			
This Spring requires Ferrea Steel Retainer #E10032 OR Ferrea Titanium Retainer #E12015 and Ferrea Spring Seat Locator # SL1088 OR Factory Seat Locator								
FORD 4.6L - 32 VALVE								
S2008	Single Beehive Ovate. PAC Alloy	.940	.580	90 lbs	252 lbs	324 lbs	.900"	.500"
	Performance OEM replacment	1.105	.742	@1.470"	@.970"			
This Spring requires Ferrea Steel Retainer # E10030 OR Ferrea Titanium Retainer # E12010 and Ferrea Spring Seat Locator #SL1086 OR Factory Seat Locator								
FORD COYOTE 5.0L - DOHC 32 VALVE - 2010-2015								
S2023	Single Beehive Ovate	.950	.636	90 lbs.	190 lbs	200 lbs	1.000"	.550"
	PAC Alloy Performance	1.061	.738	@1.600"	@1.100"			
This spring requires Ferrea Titanium Retainer # E12031 AND Ferrea Spring Seat Locator/Seal # SL1128 (Discard OEM Spring Seat Locator/Seal) NOTE: Max Net Lift is limited by the Factory hat style seat/seal locator height.								
FORD COYOTE 5.0L - DOHC 32 VALVES - 2018-2019								
S2027	Single Beehive Ovate. PAC Alloy	0.985	0.636	80 lbs	260 lbs	277 lbs	1.110"	.620"
	High Lift - Street and Strip Use	1.061	0.698	@ 1.820"	@ 1.200"			
This Spring requires either Ferrea Titanium Retainer # E12043 or Ferrea Tool Steel Retainer # E20060 and BOTH, Ferrea Spring Seat Locator # SL1178 (Hat Seal) and # SL1169. (Discard OEM Factory supplied seat locator).								
FORD VOODOO 5.2L - DOHC 32 VALVE (GT350) - 2015-2017								
S2024	Single Beehive Ovate. PAC Alloy	.985	.636	80 lbs	260 lbs	277 lbs	1.110"	.620"
	High Lift - Street and Strip Use	1.061	.698	@ 1.820"	@ 1.200"			
This Spring requires Ferrea Tool Steel Retainer #E20057 and BOTH, Ferrea Spring Seat Locator #SL1156 (Hat Seal) and #SL1159. (Discard OEM Factory supplied seat locator).								
FORD GT 500 5.4L - 32 VALVE - 2005-2007								
S2016	Single Beehive Ovate. PAC Alloy	.985	.636	100 lbs	220 lbs	285 lbs	1.000"	.600"
	High Lift application	1.061	.698	@1.700"	@1.280"			
	(INTAKE) - 16 pieces)							
This Spring requires Ferrea Titanium Retainer #E12022 and Ferrea Spring Seat Locator #SL1088 OR Factory Seat Locator								
S2017	Single Beehive Ovate. PAC Alloy	.950	.636	100 lbs	190 lbs	200 lbs	.970"	.500"
	High Lift application	1.061	.738	@1.530"	@1.080"			
	(EXHAUST - 16 pieces)							
This Spring requires Ferrea Titanium Retainer #E12022 and Ferrea Spring Seat Locator #SL1088 OR Factory Seat Locator								
STOCK ELIMINATOR								
S2012	Single Beehive Ovate. PAC Alloy	1.043	.650	175 lbs	425 lbs	436 lbs	1.190"	.550"
		1.250	.845	@1.800"	@1.250"			
Features additional processing for increased performance and durability. This Spring requires Ferrea Steel Retainer #E10034 OR Ferrea Titanium Retainer # E12024, #E12025 OR #E12007 and Ferrea Spring Seat Locator # SL1078, #SL1081 OR #SL1085								

VALVE SPRINGS

Part#	Type/Material/ Application	O.D.	I.D.	Seat Press.	Open Press.	Rate Inch	Coil Bind	Max Net Lift
DIAMETER 1.650" TO 1.600"								
S10000	Triple Spring Pacalloy Roller	.885 1.200 1.650	.645 .885 1.200	330 lbs @2.100"	950 lbs @1.200"	680 lbs	1.140"	.900"
S10001	Triple Spring Pacalloy Roller	.885 1.200 1.650	.640 .885 1.200	320 lbs @2.025"	865 lbs @1.225"	680 lbs	1.140"	.850"
S10002	Triple Spring Pacalloy Roller	.885 1.200 1.650	.640 .885 1.200	285 lbs @2.000"	790 lbs @1.250"	680 lbs	1.140"	.800"
S10003	Dual w/Damper H11 Tool Steel Roller	1.080 1.625	.767 1.189	250 lbs @1.950"	675 lbs @1.200"	570 lbs	1.150"	.750"
S10004	Dual w/Damper Chrome Silicon Roller	1.065 1.625	.770 1.175	230 lbs @2.000"	600 lbs @1.300"	550 lbs	1.200"	.700"
S11004	Dual w/Damper Special Alloy Roller	1.065 1.625	.770 1.175	250 lbs @2.020"	675 lbs @1.270"	550 lbs	1.180"	.750"
S10023	Dual w/Damper Special Alloy	1.065 1.625	.770 1.175	240 lbs @2.000"	685 lbs @1.250"	550 lbs	1.150"	.750"
S10005	Dual w/Damper Vasco Jet. Roller	1.064 1.624	.760 1.164	210 lbs @1.900"	695 lbs @1.200"	675 lbs	1.050"	.700"
S10076	Dual Spring - Special Alloy Endurance Spring	1.160 1.610	.835 1.160	262 lbs @2.000"	640 lbs @1.300"	540 lbs	1.220"	.750"
This Spring requires Ferrea Titanium Retainer # E11047LW. Maximum Retainer Step: .100"								
DIAMETERS 1.570" TO 1.225"								
S10022	Dual w/Damper Vasco Jet. Roller	1.025 1.570	.740 1.135	230 lbs @1.950"	620 lbs @1.225"	540 lbs	1.175"	.720"
S10030	Dual w/Damper Special Alloy	1.025 1.570	.740 1.135	250 lbs @ 1.900"	650 lbs @ 1.200"	600 lbs	1.125"	.660"
S11016	Dual Special Alloy Roller	1.153 1.560	.820 1.155	245 lbs @1.950"	590 lbs @1.250"	490 lbs	1.150"	.700"
S10015	Dual w/Damper Special Alloy Endurance Roller	1.040 1.560	.740 1.145	240 lbs @2.000"	600 lbs @1.280"	500 lbs	1.180"	.720"
S11011	Dual w/Damper Special Alloy Roller	1.040 1.560	.740 1.145	245 lbs @1.970"	585 lbs @1.290"	480 lbs	1.190"	.680"
S11012	Dual w/Damper Special Alloy Roller	1.040 1.560	.740 1.145	245 lbs @1.950"	585 lbs @1.270"	470 lbs	1.170"	.680"
S11014	Dual w/Damper Special Alloy W Cup Flat Tapped	1.040 1.560	.740 1.145	195 lbs @1.975"	540 lbs @1.275"	500 lbs	1.175"	.700"
S11015	Dual w/Damper Special Alloy Roller	1.040 1.560	.740 1.145	245 lbs @2.000"	600 lbs @1.300"	500 lbs	1.200"	.700"
S10014	Dual w/Damper Chrome Silicon Roller	1.025 1.550	.740 1.135	210 lbs @1.900"	520 lbs @1.240"	480 lbs	1.130"	.660"
S10011	Dual w/Damper Chrome Silicon Roller	1.025 1.550	.740 1.135	165 lbs @1.950"	465 lbs @1.300"	470 lbs	1.150"	.650"
S10012	Dual w/Damper Chrome Silicon Roller	1.025 1.550	.740 1.135	215 lbs @1.950"	550 lbs @1.270"	460 lbs	1.170"	.680"
S10010	Dual w/Damper Chrome Silicon Roller or Flat	1.040 1.550	.755 1.130	170 lbs @1.950"	463 lbs @1.275"	435 lbs	1.175"	.675"

VALVE SPRINGS

Part#	Type/Material/ Application	O.D.	I.D.	Seat Press.	Open Press.	Rate Inch	Coil Bind	Max Net Lift
DIAMETERS 1.570" TO 1.225"								
S10009	Dual w/Damper Chrome Silicon Hydraulic & Solid	1.005 1.530	.730 1.110	135 lbs @1.875"	395 lbs @1.225"	400 lbs	1.160"	.650"
S10025	Dual w/Damper Chrome Silicon Flat & Hydraulic	1.005 1.530	.730 1.110	140 lbs @ 1.900"	430 lbs @ 1.250"	440 lbs	1.170"	.650"
S10008	Dual w/Damper Chrome Silicon Flat or Hydraulic	1.005 1.430	.725 1.070	170 lbs @1.830"	368 lbs @1.210"	320 lbs	1.110"	.620"
S10006	Dual w/Damper Chrome Silicon Hydraulic & Solid	1.005 1.430	.730 1.070	135 lbs @1.750"	285 lbs @1.200"	275 lbs	1.120"	.550"
S10007	Dual Spring Chrome Silicon Flat or Hydraulic	.925 1.240	.660 .915	130 lbs @1.690"	306 lbs @1.090"	320 lbs	1.020"	.550"
CHEVROLET SMALL BLOCK - LS1								
S10042	Outer w/Damper Special Alloy	1.260	.886	130 lbs @ 1.750"	320 lbs @ 1.200"	350 lbs	1.150"	.550"
This Spring requires Ferrea Titanium Retainer # E11020 and Ferrea Spring Seat Locator # SL1030								
S10048	Outer w/Damper Super Alloy	1.260	.880	130 lbs @ 1.750"	370 lbs @ 1.200"	436 lbs	1.040"	.660"
This Spring requires Ferrea Titanium Retainer # E11020 and Ferrea Spring Seat Locator # SL1030								
S10061	Outer w/Damper. Super Alloy Endurance Application	1.270	.890	155 lbs @ 1.750"	420 lbs @ 1.100"	408 lbs	1.060"	.660"
This Spring requires Ferrea Titanium Retainer # E11020 and Ferrea Spring Seat Locator # SL1030								
S99100	Dual Spring. Pro PAC Alloy Endurance Application	.925 1.275	.650 .925	150 lbs @ 1.800"	475 lbs @ 1.100"	464 lbs	1.030"	.700"
This Spring requires Ferrea Titanium Retainer # E12000 and Ferrea Spring Seat Locator # SL1036								
CHEVROLET SMALL BLOCK - LS1/LS7 (5/16 CONVERSION KIT)								
S99101	Dual Spring. Pro PAC Alloy Endurance Application	.925 1.275	.650 .925	150 lbs @ 1.800"	475 lbs @ 1.100"	464 lbs	1.030"	.700"
This Spring requires Ferrea Titanium Retainer #E12001 and Ferrea Spring Seat Locator #SL1036 AND Ferrea Valve Guide #VG1061 (For 5/16 stem diameter valves).								
CHEVROLET SMALL BLOCK - L92								
S99102	Dual Spring. Pro PAC Alloy Endurance Application	.925 1.275	.650 .925	150 lbs @ 1.750"	425 lbs @ 1.150"	458 lbs	1.030"	.700"
This Spring requires Ferrea Titanium Retainer # E12002 and Ferrea Spring Seat Locator # SL1071 AND Ferrea Valve Guide (EXH #VG 1067) and (INT #VG1066)								
	Dual Spring. Pro PAC Alloy Racing Application	.925 1.275	.650 .925	170 lbs @ 1.800"	445 lbs @ 1.200"	458 lbs	1.140"	.600"
This Spring requires Ferrea Titanium Retainer #E12002 and Ferrea Spring Seat Locator #SL1072 AND Ferrea Valve Guide (EXH #VG 1067) and (INT #VG1066)								
FORD ECOBOOST 2.3L - DOHC 16 VALVE - 2015								
S10163	Single Spring PAC Alloy - Turbo Endurance Application	24.61 mm	17.40 mm	75 lbs @37.75mm	160 lbs @27.75mm	215.7 lbs	23.78mm	12.7mm
This spring requires Ferrea Titanium Retainer # E11135 and Ferrea Spring Seat Locator / Valve Hat Seal # SL1147. (Discard OEM Factory supplied Spring Seat Locator / Valve Hat Seal)								
FORD ECOBOOST 3.5L - DOHC 24 VALVE (TURBO) - 2010-2016								
S10167	Single Spring PAC Alloy - Turbo Endurance Application	24.61 mm	17.40 mm	75 lbs @ 37.95 mm	160 lbs @ 27.95 mm	215.7 lbs	24.35 mm	12.5 mm
This spring requires Ferrea Titanium Retainer # E11143 and Ferrea Spring Seat Locator / Valve Hat Seal # SL1155. (Discard OEM Factory supplied Spring Seat locator / Valve Hat Seal)								
FORD 4.6L / 5.4L - SOHC V8 - 24 VALVE - 2005-2007								
S10102	Dual Spring-Special Alloy Street/Strip Applications	.819 1.102	.625 .819	95 lbs @ 1.575"	267 lbs @ 1.075"	334 lbs	1.023"	.500"
This Spring requires Ferrea Titanium Retainer #E11069 and BOTH, Ferrea Spring Seat Locator #SL1055 and Factory supplied Spring Seat Locator								
FORD COYOTE 5.0L - DOHC 32 VALVE - 2010-2015								
S10146	Dual Spring-Special Alloy Street/Strip Application	.819 1.102	.650 .819	80 lbs. @1.580"	220 lbs @1.030"	254 lbs	.995"	.550"
This spring requires Ferrea Titanium Retainer # E11136 and BOTH, Ferrea Spring Seat Locator/Seal # SL1128 and Ferrea Seat Locator SL1148. (Discard OEM Spring Seat Locator/Seal) NOTE: Max Net Lift is limited by the Factory hat style seat/seal locator height.								
FORD COYOTE 5.0L - DOHC 32 VALVES - 2018-2019								
S10181	Dual Spring-PAC Enhanced High Lift - Street and Strip Use Premium RPM Performance processing	.806 1.102	.580 .806	85 lbs @ 1.800"	305 lbs @ 1.100"	315 lbs	1.060"	.700"
This Spring requires Ferrea Titanium Retainer #E11149 and BOTH, Ferrea SpringSeat Locator #SL1178 (Hat Seal) and #SL1170. (Discard OEM Factory supplied seat locator).								

VALVE SPRINGS

(COMPATIBLE W/STOCK RETAINERS - HYDRAULIC & SOLID LIFTER APPLICATIONS)

Part#	Type/Material/ Application	O.D.	I.D.	Seat Press.	Open Press.	Rate Inch	Coil Bind	Max Net Lift
FORD VOODOO 5.2L - DOHC 32 VALVE (GT350) - 2015-2017								
S10168	Dual Spring-PAC Enhanced High Lift - Street and Strip Use Premium RPM Performance processing	.806 1.102	.580 .806	85 lbs @ 1.800"	305 lbs 1.100"	315 lbs	1.060"	.700"
This Spring requires Ferrea Titanium Retainer #E11144 and BOTH, Ferrea Spring Seat Locator #SL1156 (Hat Seal) and #SL1160. (Discard OEM Factory supplied seat locator).								
AMC V-8 360-390-401 / CHEVROLET V-8 BIG BLOCK / CHRYSLER V-8 383-440 FORD BOSS 302-351 / FORD V-8 360-390-429-460								
S10020	Outer w/Damper Chrome Silicon	1.540	1.115	110 lbs @1.875"	300 lbs @1.350"	360 lbs	1.130"	.525"
CHEVROLET V-8 BIG BLOCK								
S10018	Outer w/Damper Chrome Silicon	1.530	1.110	120 lbs @1.875"	290 lbs @1.350"	330 lbs	1.120"	.525"
CHEVROLET V-6 & V-8 SMALL BLOCK / BUICK V-6 LATE MODEL								
S10017	Outer w/Damper Chrome Silicon	1.260	.860	115 lbs @1.700"	268 lbs @1.210"	310 lbs	1.160"	.490"
S10024	Outer w/Damper Chrome Silicon	1.260	.886	130 lbs @1.750"	320 lbs @1.200"	350 lbs	1.150"	.550"
FORD WINDSOR V-8 302-351 / MOPAR V-8 340-360								
S10019	Outer w/Damper Chrome Silicon	1.490	1.076	130 lbs @1.700"	320 lbs @1.200"	370 lbs	1.100"	.500"

TITANIUM RETAINERS

Part#	Valve Stem Size	Diam.(A)	Out step Diam.(B)	In step Diam.(C)	Reference
RETAINERS "SUPER 7"					
E12024	ALL	.990	-	.640	Beehive Spring. - Pro CNC Retainer Ferrea Racing Spring # S2012
E12003	ALL	1.050	-	.640	Beehive Spring. - Pro CNC Retainer Ferrea Racing Spring # S2003 & # S2004
E12023	ALL	1.130	-	.730	Beehive Spring. - Pro CNC Retainer Ferrea Racing Spring # S2005 & # S2006
E11047	ALL	1.495	1.165	.835	Double Spring. Pro CNC Ferrea Racing Springs #S10076 & #S10077
E12034	ALL	1.495	1.175	.744	Double Spring. Pro CNC Retainer
E10077	ALL	1.500	1.160	.700	Double Spring. Pro CNC Retainer
E11004	ALL	1.500	1.115	.725	Double Spring. Pro CNC Retainer
E11007	ALL	1.500	1.140	.744	Dble Spring. Pro CNC Retainer
E11137	ALL	1.500	1.175	.770	Double Spring. Pro CNC Retainer
E11009	ALL	1.500	1.185	.777	Ferrea Racing Spring # S10004 / S10023 / S11004
E11019	ALL	1.500	1.195	.880/.640	Dble Spring. Pro CNC Retainer
E11019LW	ALL	1.500	1.195	.880/.640	Triple Spring. Pro CNC Retainer. Triple Spring. Pro CNC Retainer. 16.5 grs.
RETAINERS "7 DEG."					
E10009	5/16	1.370	1.060	.725	Double Spring
E12025	11/32	.990	-	.640	Beehive Spring. - Pro CNC Retainer. Ferrea Racing Spring # S2012
E10010	11/32	1.370	1.060	.725	Double Spring
RETAINERS "10 DEG."					
E12007	ALL	.990	-	.640	Beehive Spring. - Pro CNC Retainer Ferrea Racing Spring # S2012
E12006	ALL	1.050	-	.640	Beehive Spring. - Pro CNC Retainer Ferrea Racing Spring # S2003 & # S2004
E12012	ALL	1.120	-	.725	Beehive Spring. - Pro CNC Retainer Ferrea Racing Spring # S2005 & # S2006
E11076	ALL	1.440	1.065	.700	Double Spring. Pro CNC Retainer
E12033	ALL	1.495	1.160	.700	Double Spring. Pro CNC Retainer
E11006	ALL	1.500	1.115	.725	Double Spring. Pro CNC Retainer
E11138	ALL	1.500	1.175	.770	Double Spring. Pro CNC Retainer
E11008	ALL	1.500	1.195	.880/.640	Ferrea Racing Spring # S10004 / S10023 / S11004
E11008LW	ALL	1.500	1.195	.880/.640	Triple Spring. Pro CNC Retainer
E11016	ALL	1.500	1.140	.744	Triple Spring Pro CNC Retainer. 17 grs. Double Spring. Pro CNC Retainer
CHEVROLET SMALL BLOCK - LS1/LT1					
E12014	.313	1.025	-	.642	Beehive Spring. - 7° Pro CNC Retainer Ferrea Racing Spring # S2000, # S2001 & # S2002 Ferrea Valve Lock # K10058
E12000	.313	1.210	.927	.650	Dble Spring-7 deg Pro CNC Retainer. Ferrea Racing Spring # S99100 and Ferrea Valve Lock # K10058
E11020	.313	1.235	.880	.611	Dble Spring. -7 deg Pro CNC Retainer. Can be used with OEM Valve Lock Ferrea Racing Spring # S10042, S10048 and S10061 Ferrea Valve Lock # K10058
CHEVROLET SMALL BLOCK - LS1/LS7 (5/16 CONVERSION KIT)					
E12001	5/16	1.210	.927	.660	Dble Spring. Pro CNC Retainer. "SUPER 7" Ferrea Racing Spring # S99101 and Ferrea Valve Lock # K10042

DOMESTIC APPLICATIONS

TITANIUM RETAINERS

Part#	Valve Stem Size	Diam.(A)	Out step Diam.(B)	In step Diam.(C)	Reference
CHEVROLET SMALL BLOCK - L92					
E12002	.313	1.210	.927	.650	Dble Spring. Pro CNC Retainer. " 7 DEG" Ferrea Racing Spring # S99102 and Ferrea Valve Lock # K10058
CHRYSLER/DODGE HEMI 5.7/6.1L					
E12008	.313	.995	-	.630	Beehive Spring. - 7° Pro CNC Retainer Ferrea Racing Spring #S2009. To be used with OEM Valve Lock
FORD ECOBOOST 2.3L - DOHC 16 VALVE - 2015					
E11135	5.5mm	22.22mm	-	17.52mm	Sggle Spring-7° Pro CNC (16 pieces) Ferrea Racing Springs # S10163 Ferrea Valve Lock # K10113
FORD COYOTE 5.0L - DOHC 32 VALVES - 2018-2019					
E12043	.235	.920	-	.635	Beehive Spring - 7° Pro CNC Retainer Ferrea Racing Springs# S2027 Use with OEM Triple Groove Locks
E11149	.235	1.000	-	.580	Dual Spring - 7° Pro CNC Retainer Ferrea Racing Springs# S10181 Use with OEM Triple Groove Locks
FORD ECOBOOST 3.5L - DOHC 24 VALVE (TURBO) - 2010-2016					
E11143	5.5 mm	22.22 mm	-	17.52 mm	Sggle Spring-7° Pro CNC (24 pieces) Ferrea Racing Springs # S10167 Ferrea Valve Lock # K10118
FORD 4.6L - 16 VALVE					
E12005	.274	.925	-	.625	Beehive Spring. - 7° Pro CNC Retainer Ferrea Racing Spring # S2010 AND # S2011. To be used with OEM Valve Lock
FORD 4.6L/5.4L - SOHC V8 - 24 VALVE - 2005-2007					
E12015	.235	.900	-	.560	Beehive Spring. - 7° Pro CNC Retainer Ferrea Racing Spring #S2007. To be used with OEM Valve Lock
E11069	.235	1.000	-	.618	Dble Spring-6 deg Pro CNC. Ferrea Racing Spring # S10102 and Ferrea Valve Lock # K10077
FORD 4.6L - 32 VALVE					
E12010	.274	.895	-	.575	Beehive Spring. - 7° Pro CNC Retainer. Ferrea Racing Spring # S2008. To be used with OEM Valve Lock
FORD COYOTE 5.0L - DOHC 32 VALVE - 2010-2015					
E12031	.2346	.900	.640	.400	Beehive Spring. 7° Pro CNC Retainer Ferrea Racing Springs# S2023.
E11136	.235	1.000	-	.650	Dble Spring - 7° Pro CNC Retainer Ferrea Racing Springs # S10146
FORD VOODOO 5.2L - DOHC 32 VALVE (GT350) - 2015-2017					
E11144	.235"	1.000"	-	.580"	Dual Spring-7° Pro CNC (32 pieces) Ferrea Racing Springs # S10168 Use with OEM Triple Groove Locks
FORD GT 5.4L - 32 VALVE - 2005-2007					
E12022	.275	.920	-	.635	Beehive Spring. - 7 deg. Pro CNC Retainer. Ferrea Racing Spring # S2016 & # S2017. Use Stock Triple Groove Lock

TOOL STEEL RETAINERS

Part#	Valve Stem Size	Diam.(A)	Out step Diam.(B)	In step Diam.(C)	Reference
RETAINERS "SUPER 7°"					
E20049	ALL	1.495	1.115	.725	Double Spring Pro CNC Retainer. 20.3 grs
E20050	ALL	1.495	1.140	.744	Double Spring Pro CNC Retainer. 21.3 grs
RETAINERS "7 DEG."					
E20051	11/32	1.130	.885	.603	Single Spring Pro CNC Retainer. 14 grs
RETAINERS "10 DEG"					
E20038	ALL	1.495	1.115	.725	Double Spring Pro CNC Retainer. 20.5 grs
E20039	ALL	1.495	1.140	.744	Double Spring Pro CNC Retainer. 21.5 grs
E20053	ALL	1.495	1.195	.880/.640	Triple Spring Pro CNC Retainer. grs
DODGE VIPER 8.4L V10 - GEN 4 & 5 - 2013-2017					
E20058	.313	1.025	-	.640	Beehive Spring - 7° Pro CNC Retainer Ferrea Racing Spring # S2026 Use with OEM Triple Groove Locks
FORD COYOTE 5.0L - DOHC 32 VALVES - 2018-2019					
E20060	.235	.920	-	.635	Beehive Spring - 7° Pro CNC Retainer Ferrea Racing Springs# S2027 Use with OEM Triple Groove Locks
FORD VOODOO 5.2L - DOHC 32 VALVE (GT350) - 2015					
E20057	.235	.920	-	.635	Beehive Spring - 7° Pro CNC Retainer Ferrea Racing Spring # S2024 Use with OEM Triple Groove Locks

STEEL RETAINERS

Part#	Valve Stem Size	Diam.(A)	Out step Diam.(B)	In step Diam.(C)	Reference
RETAINERS "7 DEG."					
E10012	11/32	1.365	1.060	.735	Double Spring (Use with Ferrea Lock # K10067)
CHEVROLET SMALL BLOCK - LS1/LT1					
E10029	.313	1.025	-	.642	Beehive Spring. - 7° Pro CNC Retainer. Ferrea Racing Spring #S2000, #S2001 and #S2002 Ferrea Valve Lock #K10058

STEEL RETAINERS

Part#	Valve Stem Size	Diam.(A)	Out step Diam.(B)	In step Diam.(C)	Reference
CHRYSLER/DODGE HEMI 5.7L/6.1L					
E10031	.313	.995	-	.630	Beehive Spring. - 7° Pro CNC Retainer. Ferrea Racing Spring #S2009. To be used with OEM Valve Lock
FORD 4.6L - 16 VALVE					
E10033	.274	.925	-	.625	Beehive Spring. - 7° Pro CNC Retainer. Ferrea Racing Spring #S2010 and #S2011. To be used with OEM Valve Lock
FORD 4.6L/5.4L - SOHC V8 - 24 VALVE - 2005-2007					
10032	.235	.900	-	.560	Beehive Spring. - 7° Pro CNC Retainer. Ferrea Racing Spring #S2007. To be used with OEM Valve Lock
FORD 4.6L - 32 VALVE					
E10030	.274	.895	-	.575	Beehive Spring. - 7° Pro CNC Retainer. Ferrea Racing Spring #S2008. To be used with OEM Valve Lock
STOCK ELIMINATOR					
E10034	11/32	.990	-	.640	Beehive Spring. - 7° Pro CNC Retainer. Ferrea Racing Spring #S2012. Ferrea Valve Lock #K10017
E10037	3/8	.990	-	.640	Beehive Spring. - 7° Pro CNC Retainer. Ferrea Racing Spring #S2012. Ferrea Valve Lock #K10018

TITANIUM VALVE LOCKS

Part#	Specifications
RADIAL VALVE LOCKS "SUPER 7°"	
K11000	7 mm Std.
K11001	7 mm +.050
K11002	5/16 Std.
K11003	5/16 +.050
K11004	11/32 Std.
K11005	11/32 +.050
SQUARE VALVE LOCKS "SUPER 7°"	
K11006	5/16. Std.

STEEL VALVE LOCKS

Part#	Specifications
VALVE LOCKS "SUPER 7°"	
K10046	7 mm Std. Radial Groove
K10047	7 mm +.050. Radial Groove. Recess for lash caps
K10000	5/16 Std.
K10042	5/16 Std. Radial Groove
K10001	5/16 +.050
K10050	5/16 +.050. Recess for lash caps
K10043	5/16 +.050. Radial Groove. Recess for lash caps
K10003	11/32 Std.
K10044	11/32 Std. Radial Groove
K10004	11/32 + .050
K10045	11/32 +050. Radial Groove. Recess for lash caps
K10006	3/8 Std.
K10007	3/8 + .050
VALVE LOCKS "6 DEG."	
K10111	6 mm Radial Groove - Top Lock
VALVE LOCKS "7 DEG."	
K10085	7 mm Std. Radial Groove
K10086	7 mm Std. Radial Groove. Shoulder Locks
K10016	5/16 Std.
K10104	5/16. Radial Groove Std. Specially designed for Ferrea Hollow Stem Valves Series
K10058	.313 Std. Radial Groove. LS1, LS6, LS7 and L92
K10105	.313 - .050 Radial Groove. LS1, LS6, LS7 and L92
K10114	.313 +.050 Radial Groove. LS1, LS6, LS7, and L92
K10017	11/32 Std.
K10067	11/32. Radial Groove Std. Specially designed for Ferrea Hollow Stem Valves Series
K10109	11/32 +.050 Radial
K10110	11/32 -.050 Radial
K10018	3/8 Std.
VALVE LOCKS "10 DEG."	
K10009	5/16 Std.
K10010	5/16 + .050
K10039	5/16 Std. Radial Groove. Recess for lash caps
K10051	5/16 +.050. Recess for lash caps
K10011	11/32 Std. Recess for lash caps
K10012	11/32 + .050
K10033	11/32 Std. Radial Groove. Recess for lash caps
K10112	11/32 Std. Radial Groove. Recess for lash caps
K10115	11/32 Std. Radial Groove. No Recess for lash caps
K10038	11/32 +.050. Radial Groove. Recess for lash caps
K10014	3/8 Std.
K10015	3/8 + .050
FORD ECOBOOST 2.3L - DOHC 16 VALVE - 2015	
K10113	5.5mm. Radial Groove
FORD ECOBOOST 3.5L - DOHC 24 VALVE (TURBO) - 2010-2016	
K10118	5.5 mm. Radial Groove
FORD 4.6L/5.4L - SOHC V8 - 24 VALVE - 2005-2007	
K10077	.235", Radial Groove

DOMESTIC APPLICATIONS

STEEL VALVE SUPER LOCKS

Part#	Specifications
VALVE SUPERLOCKS "SUPER 7⁰⁰"	
K10049 (*)	.275 (7 mm) Std. Radial Groove. To be used with Ferrea Lash Caps Part #C10005
K10048 (*)	5/16 Std. Radial Groove. To be used with Ferrea Lash Caps Part # C10006, C10007, C10009 or C10010
K10020 (*)	11/32 Std. To be used with Ferrea Lash Caps Part # C10012
K10027 (*)	11/32 Top Fuel .305 ID. To be used with Ferrea Lash Caps Part # C10012
VALVE SUPERLOCKS "10 DEG." (lash caps with locking steps)**	
K10023 (*)	5/16 Std. Radial Groove. To be used with Ferrea Lash Caps Part # C10006, C10007, C10009 or C10010
K10054 (*)	5/16 Std. Radial Groove. To be used with Ferrea Lash Caps Part # C10014**, C10015** or C10016**
K10024 (*)	11/32 Std. To be used with Ferrea Lash Caps Part # C10012
K10053 (*)	11/32 Std. Radial Groove. To be used with Ferrea Lash Caps Part # C10012
K10055 (*)	11/32 Std. Radial Groove. To be used with Ferrea Lash Caps Part # C10017**

(*) It may be used without lash caps. Please specify when you order.

SPRING SEAT LOCATORS

Part#	Locator Thickness	Locator O.D.	Locator I.D.	Spring O.D.	Spring I.D.	References
CHEVROLET BIG BLOCK						
SL1074	.060	1.490	.570	1.445	1.000	Required for Ferrea Springs #S2003 and #S2004
SL1077	.060	1.490	.630	1.445	1.000	Required for Ferrea Springs #S2003 and #S2004
CHEVROLET SMALL BLOCK - LS1/LT1						
SL1080	.060	1.300	.505	1.290	.885	Required for Ferrea Springs #S2000, #S2001
SL1030	.090	1.245	.505	N/A	.870	Required for Ferrea Springs # S10042, #S10048, and #S10061
SL1036	.060	1.245	.505	N/A	.635	Required for Ferrea Springs #S10075, #S99100
CHEVROLET SMALL BLOCK - LS1/LS7 (5/16 CONVERSION KIT)						
SL1066	.060	1.245	.562	N/A	.660	Required for Ferrea Springs # S99101 and Ferrea Valve Guide #VG1061.
CHEVROLET SMALL BLOCK - L92						
SL1071	.060	1.240	.505	N/A	.650	Required for Ferrea Springs # S99102.Valve Guides Ferrea (EXH #VG1067) and (INT #VG1066) OR Factory supplied Valve Guides
SL1072	.060	1.240	.505	N/A	.650	Required for Ferrea Springs # S99102.Valve Guides Ferrea (EXH #VG1067) and (INT #VG1066) OR Factory supplied Valve Guides. This seat locator is designed with a step for HIGH PRESSURE
CHRYSLER/DODGE HEMI 5.7/6.1L						
SL1079	.045	1.375	0.665	1.210	0.805	Required for Ferrea Springs #S2009 Seat Locator and Valve Seal one piece assembly
DODGE VIPER 8.4L V10 - GEN 4 & 5 - 2013-2017						
SL1157	.050	1.445	.750	1.445	1.000	Required for Ferrea Spring #S2026
SL1158	.045	1.355	.750	1.445	-	Required for Ferrea Spring #S2026 Seat Locator and Valve Seal one piece assembly
ENDURANCE HIGH LIFT						
SL1075	.060	1.590	1.130	1.589	1.135	Required for Ferrea Springs #S2006
FLAT TAPPET & HYDRAULIC ROLLER						
SL1083	.060	1.450	.980	1.445	.990	Required for Ferrea Springs #S2005
FORD ECOBOOST 2.3L - DOHC 16 VALVE - 2015						
SL1147	1mm	25mm	15.37mm	22.22mm	17mm	Required for Ferrea Springs # S10163 Seat Locator and Valve Seal one piece assembly
FORD ECOBOOST 3.5L - DOHC 24 VALVE (TURBO) - 2010-2016						
SL1155	1 mm	25 mm	15.37 mm	22.22mm	17mm	Required for Ferrea Springs # S10167 Seat Locator and Valve Viton Seal one piece assembly
FORD 4.6L - 16 VALVE						
SL1076	.040	1.107	.650	1.061	.698/.738	Required for Ferrea Springs #S2010, #S2011 Seat Locator and Valve Seal one piece assembly
FORD 4.6L/5.4L - SOHC V8 - 24 VALVE - 2005-2007						
SL1088	.040	1.061	.585	1.025	.662	Required for Ferrea Springs #S2007 Seat Locator and Valve Seal one piece assembly
SL1055	.295	1.106	.660	N/A	.818	Required for Ferrea Springs #S99102
FORD 4.6L - 32 VALVE						
SL1086	.035	1.110	.635	1.105	.742	Required for Ferrea Springs #S2008 Seat Locator and Valve Seal one piece assembly
FORD COYOTE 5.0L - DOHC 32 VALVE - 2010-2015						
SL1128	.040	1.061	.585	1.061	.656	Required for Ferrea Springs # S2023 / S10146 Seat Locator and Valve Seal one piece assembly
SL1148	.270	1.100	.661	1.102	.815	Required for Ferrea Springs # S10146
FORD COYOTE 5.0L - DOHC 32 VALVES - 2018-2019						
SL1178	.040	1.055	.660	1.055	-	Required for Ferrea Springs # S2027 & S10181 Seat Locator and Valve Viton Seal one piece assembly
SL1169	.080	1.050	.675	1.055	.698	Required for Ferrea Springs # S2027
SL1170	.185	1.100	.675	1.100	.806	Required for Ferrea Springs # S10181
FORD VOODOO 5.2L - DOHC 32 VALVE (GT350) - 2015-2017						
SL1156	.040"	1.055"	.660"	1.055"	-	Required for Ferrea Springs # S2024 & S10168 Seat Locator and Valve Viton Seal one piece assembly
SL1159	.080"	1.050"	.675"	1.055"	.698"	Required for Ferrea Springs # S2024
SL1160	.185"	1.100"	.675"	1.100"	.806"	Required for Ferrea Springs # S10168
FORD GT 500 5.4L - 32 VALVE - 2005-2007						
SL1087	.040	1.107	.650	1.061	.698/.738	Required for Ferrea Springs #S2017 Seat Locator and Valve Seal one piece assembly
STOCK ELIMINATOR						
SL1078	.060	1.250	.535	1.250	.845	Required for Ferrea Springs #S2012
SL1081	.060	1.250	.570	1.250	.845	Required for Ferrea Springs #S2012
SL1085	.060	1.250	.630	1.250	.845	Required for Ferrea Springs #S2012

LASH CAPS

Part#	Specifications
LASH CAPS	
C10004	5.5 mm - .216 ID - .100 Deep
C10008	6 mm - .2358 ID - .085 Deep
C10011	6.08 mm - .239 ID - .120 Deep Ford Focus 2.0L (for Valve Stem Stock size)
C10005	7 mm - .274 ID - .160 Deep. To be used with Superlock
C10006	5/16 - .308 ID - .115 Deep. To be used with Superlock
C10007	5/16 - .308 ID - .160 Deep. To be used with Superlock
C10014*	5/16 - .309 ID - .115 Deep. Only for valves with .200 tip length. To be used with Ferrea Lock #K10054
C10015*	5/16 - .309 ID - .163 Deep. Only for valves with .250 tip length. To be used with Ferrea Lock #K10054
C10010	5/16 - .310 ID - .115 Deep. To be used with Superlock
C10009	5/16 - .310 ID - .160 Deep. To be used with Superlock
C10016*	5/16 - .310 ID - .163 Deep. Only for valves with .250 tip length. To be used with Ferrea Lock #K10054
C10022	5/16 - .310 ID - .150 Deep. Thickness .080
C10000	5/16 Std.
C80001	8 mm - .313 ID - .160 Deep. Valves with minimum of .290 tip length
C10001	11/32 Std.
C10021	11/32 - .3415 ID - .110 Deep - .175 OAL
C10012	11/32 - .3415 ID - .460 OD - .160 Deep. To be used with Superlock
C10017*	11/32 - .3415 ID - .163 Deep. Only for valves with .250 tip length. To be used with Ferrea Lock #K10055
C10002	3/8 Std.

*Lash Caps with a "locking step"

COPPER BRONZE VALVE GUIDES

Part#	Specifications
BRODIX BIG & SMALL BLOCK	
VG1017	Exhaust & Intake 11/32. OD .545". O/A Length 2.000" - Valve seal .530 (ID)
VG1018	Exhaust & Intake 11/32. OD .545". O/A Length 2.250" - Valve seal .530 (ID)
VG1019	Exhaust & Intake 11/32. OD .545". O/A Length 2.375" - Valve seal .530 (ID)
BIG & SMALL BLOCK (7 mm)	
VG1052	Exhaust 7 mm. OD .502". O/A Length 2.240" - Valve seal .520" (ID)
VG1053	Exhaust 7 mm. OD .503". +.001" oversize. O/A Length 2.240" - Valve seal .520" (ID)
VG1033	Exhaust 7 mm. OD .545". O/A Length 2.250" - Undersize.060" (for more valve lift). Valve seal .500" (ID)
VG1008	Intake 7 mm. OD .502". O/A Length 2.600" - Valve seal .520" (ID)
VG1054	Intake 7 mm. OD .503" + .001" oversize. O/A Length 2.600" - Valve seal .520" (ID)
VG1032	Intake 7 mm. OD .545". O/A Length 2.375" - Undersize.060" (for more valve lift). Valve seal .500" (ID)
BIG & SMALL BLOCK (5/16)	
VG1011	Exhaust 5/16. OD .502". O/A Length 2.240" - Valve seal .530" (ID)
VG1070	Exhaust 5/16. OD .502". O/A Length 2.240" - Valve seal .500" (ID)
VG1087	Exh & Int 5/16. OD .545". O/A Length 2.000" - Valve seal .530" (ID). Use Ferrea Valve Seal Part# VS1020
VG1088	Exh & Int 5/16. OD .545". O/A Length 2.600" - Valve seal .530" (ID). Use Ferrea Valve Seal Part# VS1020
VG1010	Intake 5/16. OD .502". O/A Length 2.600" - Valve seal .530" (ID). Use Ferrea Valve Seal Part# VS1020
VG1010B	Intake 5/16. OD .502". O/A Length 2.600" - Valve seal .500" (ID). Use Ferrea Valve Seal Part# VS1021
BIG & SMALL BLOCK (11/32)	
VG1014	Exhaust 11/32. OD .502". O/A Length 2.240" - Valve seal .530" (ID)
VG1030	Exhaust 11/32. OD .502". O/A Length 2.240". Valve seal .500" (ID). Blank, no-taper on end.
VG1012	Intake 11/32. OD .502". O/A Length 2.600" - Valve seal .530" (ID)
VG1029	Intake 11/32. OD .502". O/A Length 2.600" - Valve seal .500" (ID). Blank, no-taper on end.
CHEVROLET SMALL BLOCK - LS1	
VG1020	Exhaust & Intake .3138. OD .502". O/A Length 2.000" - Valve seal .500 (ID) (for double spring)
CHEVROLET SMALL BLOCK - LS1/LS7 (5/16 CONVERSION KIT)	
VG1061	Exhaust & Intake 5/16 OD .502". O/A Length 2.000" - Valve seal .500 Use Ferrea Valve Seal Part# VS1021
CHEVROLET SMALL BLOCK - L92	
VG1067	Exhaust. OD .501" Length 2.000" - Valve seal .500 (ID). Use Ferrea Valve Seal Part# VS1021
VG1066	Intake. OD .501" Length 2.000" - Valve seal .500 (ID). Use Ferrea Valve Seal Part# VS1021
DODGE VIPER 8.4L V10 - GEN 4 & 5 - 2013-2017	
VG1106	EXH & INT .313". OD .5775". O/A Length 2.650". Use Ferrea Seat Locator / Hat Seal # SL1158
VG1107	EXH & INT .313". OD .5785". O/A Length 2.650". Use Ferrea Seat Locator / Hat Seal # SL1158
FORD COYOTE 5.0L - DOHC 32 VALVES - 2010-2015	
VG1094	Exh & Int .235" (6mm). OD .4397". O/A Length 1.710". Use Ferrea Seat Locator and Valve Seal # SL1128
FORD ECOBOOST 3.5L - DOHC 24 VALVE (TURBO) - 2010-2016	
VG1104	EXH & INT .215" (5.5mm). OD .435" (11.06mm). O/A Length 1.398" (35.5mm). Use Ferrea Seat Locator and Valve Seal # SL1155
VG1105	EXH & INT .215" (5.5mm). OD .436" (11.085mm). O/A Length 1.398" (35.5mm). Use Ferrea Seat Locator and Valve Seal # SL1155
FORD GT500 4.6L/5.4L - DOHC 32 VALVES - 2010-2015	
VG1093	Exh & Int .2748" (7mm). OD .4956". O/A Length 1.930". ID decarborizing step. Use Ferrea Seat Locator and Valve Seal # SL1086 or SL1087
FORD COYOTE 5.0L - DOHC 32 VALVES - 2018-2019	
VG1117	EXH & INT .235" (6mm). OD .440". Use Ferrea Hat Seat Locator and Valve Seal # SL1178
FORD VOODOO 5.2L - DOHC 32 VALVE (GT350) - 2015-2017	
VG1108	EXH & INT .235" (6mm). OD .440". Use Ferrea Seat Locator and Valve Seal # SL1156
GM DART & WORLD PRODUCTS (CAST IRON HEAD)	
VG1021	Exhaust & Intake 11/32. OD .502". O/A Length 2.000" - Undersize .060 (for more valve lift) - Valve seal .500 (ID) (for double spring)
PRO STOCK	
VG1024	Exhaust & Intake .309". OD .502". O/A Length 3.500" - Valve seal ID .625" x .800

DOMESTIC APPLICATIONS

VALVE SEALS

Part#	Specifications
BIG & SMALL BLOCK (7mm, 5/16, 8mm, 11/32)	
VS1031	Exhaust & Intake 7 mm valve stem. Viton rubber compound. Hi Temp. .500" ID. Use Ferrea Valve Guides # VG1032 AND VG1033
VS1020	Exhaust & Intake 5/16-8 mm valve stem. Viton rubber compound. Hi Temp. .530" ID. Use Ferrea Valve Guides # VG1011 #VG1055, #VG 1066 AND #VG1067
VS1021	Exhaust & Intake 5/16-8 mm valve stem. Viton rubber compound. Hi Temp. .500" ID. Use Ferrea Valve Guide # VG1011, VG1020, VG1055, VG1061, VG1066, VG1067
VS1026	Exhaust & Intake 11/32 valve stem. Viton rubber compound. Hi Temp. .500" ID. Use Ferrea Valve Guides # VG1021, #VG1029 AND #VG1030
VS1027	Exhaust & Intake 11/32 valve stem. Viton rubber compound. Hi Temp. .530" ID. Use Ferrea Valve Guide # VG1012 AND #VG1014



HIGH POWER VALVETRAIN COMPONENTS

2020
APPLICATION
GUIDE

SPORT COMPACT

SUPER ALLOY VALVES

Part#	Type	Head Diam.	Stem Diam.	Overall Length	Tip Length	References
ACURA INTEGRA GSR 1.7L - DOHC VTEC 16 VALVE (B17A1) - 1992-1993						
ACURA INTEGRA GSR 1.8L - DOHC VTEC 16 VALVE (B18C1-C3) - 1994-2000						
F1449P	E	28 mm	5.45 mm	102.5 mm	2.5 mm	25° Flo Stock size. Super Alloy
F1447P	E	28.5 mm	5.45 mm	102.5 mm	2.5 mm	25° Flo - .5 mm oversize. Super Alloy
F1445P	E	29 mm	5.45 mm	102.5 mm	2.5 mm	25° Flo - 1 mm oversize. Super Alloy
ACURA INTEGRA LS-GS 1.8L - DOHC 16 VALVE (B18A1-B1) - 1990-2000						
F1815P	E	28 mm	6.54 mm	106.02 mm	4.1 mm	30° Flo Dish Head - Stock size. Super Alloy
F1488P	E	28.5 mm	6.54 mm	106.02 mm	4.1 mm	30° Flo Dish Head - .5mm oversize. Super Alloy
F1489P	E	29 mm	6.54 mm	106.02 mm	4.1 mm	30° Flo Dish Head - 1mm oversize. Super Alloy
ACURA TSX 2.4L - DOHC i-VTEC 16 VALVE (K24Z3) - 2009-2014						
ACURA ILX 2.4L - DOHC i-VTEC 16 VALVE (K24Z7) - 2013-2015						
F2389P	E	31 mm	5.45 mm	109.3 mm	2.1 mm	25° Flo. Stock size. Super Alloy
F2391P	E	32 mm	5.45 mm	109.3 mm	2.1 mm	25° Flo. 1 mm oversize. Super Alloy
AUDI 2.0T FSI - DOHC 16 VALVE - 2006-2008						
AUDI 2.0T TFSI - DOHC 16 VALVE - 2009-2013						
F2177P	E	28mm	5.97 mm	102 mm	5 mm	24° Flo. Stock size. Triple Groove. Super Alloy
F2178P	E	29mm	5.97 mm	102 mm	5 mm	24° Flo. + 1 mm oversize. Triple Groove. Super Alloy
AUDI TTRS / RS3 2.5L TFSI - DOHC 20 VALVE (DAZA) TURBO - 2017-2018						
F2417P	E	28mm	5.97 mm	102 mm	5 mm	24° Flo. Stock Size. Triple Groove. Super Alloy
F2418P	E	29mm	5.97 mm	102 mm	5 mm	24° Flo. +1 mm oversize. Triple Groove. Super Alloy
BMW E46 3.2L - DOHC 24 VALVE (S54) - 2001-2006						
F2360P	E	30.5 mm	5.96 mm	119.2 mm	1.1 mm	30° Taper Flo. Stock size. Triple radial groove. Super Alloy
BMW E60/E82/E91/E92 3.0L - DOHC 24 VALVE (N54) - 2007-2010						
F2365P	E	28 mm	5.96 mm	114.75 mm	4.7 mm	19° Taper Flo. Stk size. Triple radial groove. Super Alloy
F2366P	E	28.5 mm	5.96 mm	114.75 mm	4.7 mm	19° Taper Flo. +.5mm oversize. Triple radial groove. Super Alloy
NOTE: The Exhaust valves feature a 1mm reduction stem in the tip area to allow the use of the OEM Factory rocker arm.						
BMW M3/M4 3.0L - DOHC 24 VALVE (S55) TWIN TURBO - 2015-2019						
F2428P	E	28.0 mm	5.96 mm	112.83 mm	5.20 mm	21° Taper Flo. Stock size. Triple radial groove. Super Alloy
NOTE: The Exhaust valves feature a 1mm reduction stem in the tip area to allow the use of the OEM Factory rocker arm.						
FORD ESCORT 2.0L - DOHC ZETEC 16 VALVE (ZX2) - 1999-2001						
FORD FOCUS 2.0L - DOHC ZETEC 16 VALVE (ZX3) - 2000-2001						
F1817P	E	27.96mm	6.012mm	96.56mm	5.25 mm	25° Flo. Stock size. (Super Alloy)
F1959P	E	28.96mm	5.500mm	97.16mm	5.25 mm	25° Flo. 1 mm oversize. (Super Alloy)
F1818P	E	28.96mm	6.012mm	96.56mm	5.25 mm	25° Flo. 1 mm oversize. (Super Alloy)
FORD ECOBOOST 2.3L - DOHC 16 VALVE - 2015						
F2370P	E	30mm	5.46mm	104.75mm	3.75mm	25° Taper Flo. Stock. Super Alloy
F2371P	E	30.5mm	5.46mm	104.75mm	3.75mm	25° Taper Flo. +.5mm Oversize. Super Alloy
HONDA ACCORD LX 2.4L - DOHC i-VTEC 16 VALVE (K24Z2) - 2008-2012						
HONDA CIVIC Si 2.4L - DOHC i-VTEC 16 VALVE (K24Z7) - 2012-2015						
F2389P	E	31 mm	5.45 mm	109.3 mm	2.1 mm	25° Flo. Stock size. Super Alloy
F2391P	E	32 mm	5.45 mm	109.3 mm	2.1 mm	25° Flo. 1 mm oversize. Super Alloy
HONDA CIVIC 1.6L - SOHC 16 VALVE (D16Z6-Y5-Y7-Y8) - 1992-2000						
F1821P	E	26 mm	5.46 mm	115.95 mm	1.9 mm	22° Flo. Stock size. Super Alloy
F1495P	E	27 mm	5.46 mm	115.95 mm	1.9 mm	22° Flo. 1 mm oversize. Super Alloy
HONDA CIVIC CRX SI 1.6L - SOHC 16 VALVE (D16A6) - 1988-1991						
F1857P	E	25 mm	5.5 mm	118.75 mm	4.35 mm	25° Flo. Stock size. Super Alloy
F1858P	E	26 mm	5.5 mm	118.75 mm	4.35 mm	25° Flo. 1 mm oversize. Super Alloy
HONDA DEL SOL 1.6L - DOHC VTEC 16 VALVE (B16A1) - 1994-1997						
HONDA CIVIC SI 1.6L - DOHC VTEC 16 VALVE (B16A3) - 1999-2000						
F1449P	E	28 mm	5.45 mm	102.5 mm	2.5 mm	25° Flo Stock size. Super Alloy
F1447P	E	28.5 mm	5.45 mm	102.5 mm	2.5 mm	25° Flo - .5 mm oversize. Super Alloy
F1445P	E	29 mm	5.45 mm	102.5 mm	2.5 mm	25° Flo - 1 mm oversize. Super Alloy
HONDA CRV 2.0L - DOHC 16 VALVE (B20A-B20Z) - 1997-2000						
F1815P	E	28 mm	6.54 mm	106.02 mm	4.1 mm	30° Flo Dish Head - Stock soze. Super Alloy
F1488P	E	28.5 mm	6.54 mm	106.02 mm	4.1 mm	30° Flo Dish Head - .5 mm oversize. Super Alloy
F1489P	E	29 mm	6.54 mm	106.02 mm	4.1 mm	30° Flo Dish Head - 1 mm oversize. Super Alloy
HONDA CIVIC TYPE-R 2.0L - DOHC VTEC 16 VALVE (K20C1-TURBO) - 2017-2018						
F2394P	E	29 mm	5.47 mm	114.75 mm	2.1 mm	28° Taper Flo. Stock size. Super Alloy
F2395P	E	30 mm	5.47 mm	114.75 mm	2.1 mm	28° Taper Flo. +1 mm oversize. Super Alloy
HONDA PRELUDE 2.2L - DOHC VTEC 16 VALVE (H22A1-A4) - 1993-2000						
F1823P	E	30 mm	5.48 mm	107.1 mm	1.9 mm	22° Flo. Stock size. Super Alloy
F1958P	E	30.5 mm	5.48 mm	107.1 mm	1.9 mm	22° Flo - .5 mm oversize. Super Alloy
F1458P	E	31 mm	5.48 mm	107.1 mm	1.9 mm	22° Flo. 1 mm oversize. Super Alloy
HYUNDAI GENESIS 2.0L - DOHC 16 VALVE (TURBO BK) - 2008-2010						
F2181P	E	29 mm	5.46 mm	105.90 mm	2.32 mm	25° Flo. Stock size. Single Groove. Super Alloy
F2174P	E	30 mm	5.46 mm	105.90 mm	2.32 mm	25° Flo. + 1 mm oversize. Single Groove. Super Alloy
INFINITI V6 3.0L - DOHC 24 VALVE (VR30DDTT) - 2015-2018						
F2411P	E	28.50mm	5.46mm	97.50mm	8.5mm	25° Taper Flo. Stock size. Super Alloy
F2412P	E	29.50mm	5.46mm	97.50mm	8.5mm	25° Taper Flo. +1mm Over size. Super Alloy
LAMBORGHINI V10 5.0L - DOHC 40 VALVE - 2003-2007						
F2284P	E	28 mm	5.97 mm	102 mm	5 mm	24° Flo. Stock size. Triple Groove. Super Alloy
LOTUS ELISE / EXIGE 1.8L - DOHC 16 VALVE (2ZZ-GE) - 2008						
F2190P	E	29 mm	5.45 mm	111.8 mm	5.4 mm	25° Super Flo. Stock size. Single Groove. Super Alloy
F2191P	E	30 mm	5.45 mm	111.8 mm	5.4 mm	25° Taper Flo. + 1 mm oversize. Single Groove. Super Alloy

SUPER ALLOY VALVES

Part#	Type	Head Diam.	Stem Diam.	Overall Length	Tip Length	References
MITSUBISHI EVOLUTION X 2.0L - DOHC 16 VALVE (4B11T) 2007-2009						
F2181P	E	29 mm	5.46 mm	105.90 mm	2.32 mm	25° Taper Flo. Stock size. Single Groove. Super Alloy
F2174P	E	30 mm	5.46 mm	105.90 mm	2.32 mm	25° Taper Flo. + 1 mm oversize. Single Groove. Super Alloy
NISSAN 280 ZX 2.8L - SOHC 12 VALVE (L28E-TURBO L28ET) - 1981-1983						
F1841P	E	35 mm	8 mm	115.25 mm	3 mm	20° Flo. Stock size. Super Alloy
F1842P	E	36 mm	8 mm	115.25 mm	3 mm	20° Flo. 1 mm oversize. Super Alloy
NISSAN 300 ZX 3.0L - SOHC 12 VALVE (VG30D-TURBO VG30T) - 1984-1989						
F1845P	E	35.1 mm	8 mm	124.5 mm	4.5 mm	20° Flo. Stock size. Super Alloy
F1846P	E	36.1 mm	8 mm	124.5 mm	4.5 mm	20° Flo. 1 mm oversize. Super Alloy
NISSAN 300 ZX 3.0L - DOHC 24 VALVE (VG30D-TURBO VG30DTT) - 1990-1996						
F1849P	E	29.5 mm	6 mm	103.65 mm	3.5 mm	25° Flo. Stock size. Super Alloy
F1850P	E	30.5 mm	6 mm	103.65 mm	3.5 mm	25° Flo. 1 mm oversize. Super Alloy
NISSAN 350 Z 3.5 L - V-6 - DOHC 24 VALVE (VQ35) - 2003-2008						
F1565P	E	32.35mm	5.96mm	94mm	3.5mm	22° Flo. Radial Grov. + 1mm o/size.
NISSAN ALTIMA 2.4L - DOHC 16 VALVE (KA24DE) - 1995-1999						
NISSAN 240 SX 2.4L - DOHC 16 VALVE (KA24DE) - 1991-1998						
F1837P	E	31.3 mm	7 mm	98.85 mm	4.5 mm	25° Flo. Stock size. Super Alloy
F1838P	E	32.3 mm	7 mm	98.85 mm	4.5 mm	25° Flo. 1 mm oversize. Super Alloy
NISSAN GT-R 3.8 L V-6 - DOHC 24 VALVE (VR38DETT) - 2009-2010						
F2234P	E	32.2 mm	5.97 mm	92 mm	2.1 mm	24° Taper Flo. Stock size. Super Alloy. Turbo Application
F2235P	E	33.2 mm	5.97 mm	92 mm	2.1 mm	24° Taper Flo. + 1mm o/size. . Super Alloy. Turbo Application
NISSAN PATROL 4.8L 6 CYL IN LINE - 24 VALVE - (TB48DE) - 2004-2010						
F2153P	E	33.5 mm	6.96 mm	98.3 mm	3.5 mm	20° Flo. Stock size. Super Alloy. Turbo Application
F2154P	E	34.5 mm	6.96 mm	98.3 mm	3.5 mm	20° Flo. +1 mm oversize. Super Alloy. Turbo Application
F2166P	E	35 mm	6.96 mm	98.3 mm	3.5 mm	20° Flo. +1.5 mm oversize. Super Alloy. Turbo Application
Tech Note: Both, Exhaust Valves feature a 1 mm reduction stem in the groove area to allow the use of the same springs, retainers and locks.						
NISSAN SENTRA SE-R 2.0L - DOHC 16 VALVE (SR20DE) - 1991-1998						
F1869P	E	30.15 mm	5.94 mm	102.4 mm	3.5 mm	22° Flo. Stock size. Super Alloy
F1870P	E	31.15 mm	5.94 mm	102.4 mm	3.5 mm	22° Flo. 1 mm oversize. Super Alloy
NISSAN SKYLINE 6 CYL IN LINE - 24 VALVE - (RB25DET) - 1993-1997						
F2149P	E	29.6 mm	5.96 mm	88.95 mm	3.2 mm	21° Flo. Stock size. Super Alloy. Turbo Application
F2150P	E	30.6 mm	5.96 mm	88.95 mm	3.2 mm	21° Flo. + 1 mm oversize. Super Alloy. Turbo Application
PORSCHE 996TT 3.6L - FLAT 6 CYL - DOHC 24 VALVE - 2000-2005						
F2271P	E	32 mm	5.95 mm	109.1 mm	3.7 mm	21° Flo. Stock size. Single radial groove. Super Alloy
F2272P	E	33 mm	5.95 mm	109.1 mm	3.7 mm	21° Flo. Oversize. Single radial groove. Super Alloy
Tech Note: These Ferrea Racing Valves come with single radial grooves. For racing applications, Ferrea does not recommend the use of triple radial grooved valves. These valves are designed to be used only with Ferrea Valve Train Kit components. Ferrea offers Triple Radial Groove OEM design valves through special custom orders only.						
SCION FR-S 2.0L - DOHC 16 VALVE (4U-GSE) - 2012-2014						
F2356P	E	29mm	5.45mm	95.3mm	7.5mm	29° Flo. Stock size. Super Alloy
F2359P	E	30mm	5.45mm	95.3mm	7.5mm	29° Flo. +1mm oversize. Super Alloy
SCION FR-S 2.0L - DOHC 16 VALVE (4U-GSE) - 2015						
F2378P	E	29mm	5.45mm	97.6mm	10.1mm	29° Flo. Flat Head. Stock. Super Alloy
F2380P	E	30mm	5.45mm	97.6mm	10.1mm	29° Flo. Flat Head. +1mm. Super Alloy
SUBARU WRX 2.0L - DOHC 16 VALVE (STI) - 2004-2008						
F1514P	E	32 mm	5.96 mm	104.75 mm	3.5 mm	25° Flo. Stock size. Super Alloy
F1519P	E	33 mm	5.96 mm	104.75 mm	3.5 mm	25° Flo. + 1 mm oversize. Super Alloy
SUBARU BRZ 2.0L - DOHC 16 VALVE (FA20) - 2012-2014						
F2356P	E	29mm	5.45mm	95.3mm	7.5mm	29° Flo. Stock size. Super Alloy
F2359P	E	30mm	5.45mm	95.3mm	7.5mm	29° Flo. +1mm oversize. Super Alloy
SUBARU BRZ 2.0L - DOHC 16 VALVE (FA20) - 2015						
F2378P	E	29mm	5.45mm	97.6mm	10.1mm	29° Flo. Flat Head. Stock. Super Alloy
F2380P	E	30mm	5.45mm	97.6mm	10.1mm	29° Flo. Flat Head. +1mm. Super Alloy
TOYOTA 1.8L - DOHC 16 VALVE (2ZZ-GE) - 2003-2006						
F2190P	E	29 mm	5.45 mm	111.8 mm	5.4 mm	25° Super Flo. Stock size. Single Groove. Super Alloy
F2191P	E	30 mm	5.45 mm	111.8 mm	5.4 mm	25° Super Flo. + 1 mm oversize. Single Groove. Super Alloy
TOYOTA MR2 2.0L - DOHC 16 VALVE (TURBO 3SGTE) - 1990-1995						
F1865P	E	29 mm	6 mm	99.5 mm	3.5 mm	25° Flo. Stock size. Super Alloy
F1866P	E	30 mm	6 mm	99.5 mm	3.5 mm	25° Flo. 1 mm oversize. Super Alloy
TOYOTA FJ CRUISER V6 4L - DOHC 24 VALVE (1GR-FE) - 2006-2008						
F1286P	E	29.5 mm	5.46 mm	105.95 mm	2.25 mm	25° Taper Flo. Stock size. Single Groove. Super Alloy
F1287P	E	30.5 mm	5.46 mm	105.95 mm	2.25 mm	25° Taper Flo. + 1 mm oversize. Single Groove. Super Alloy
TOYOTA LANDCRUISER 4.5L - DOHC 24 VALVE (1FZFE) - 1993-1997						
F2185P	E	32 mm	6.97 mm	98.25 mm	2.54 mm	22° Flo. Stock size. Super Alloy. Turbo Applications
F2186P	E	33 mm	6.97 mm	98.25 mm	2.54 mm	22° Flo. + 1 mm oversize. Super Alloy. Turbo Applications
TOYOTA SUPRA 3.0L - DOHC 24 VALVE (7MGE-TURBO 7MGTE) - 1986-1992						
F1861P	E	27.5 mm	6 mm	98.05 mm	4 mm	25° Flo. Stock size. Super Alloy
F1862P	E	28.5 mm	6 mm	98.05 mm	4 mm	25° Flo. 1 mm oversize. Super Alloy
TOYOTA SUPRA 3.0L I/L 6 CYL - DOHC 24 VALVE (2JZGE-2JZGTE) - 1994-1998						
F1499P	E	29 mm	5.98 mm	99.1 mm	3.5 mm	22° Flo. Stock size. Super Alloy
F1497P	E	30 mm	5.98 mm	99.1 mm	3.5 mm	22° Flo. 1 mm oversize. Super Alloy
TOYOTA SUPRA 3.0L - DOHC 24 VALVE (B58) TURBO - 2019						
F2430P	E	28.50 mm	5.96 mm	99.80 mm	4.98 mm	21° Taper Flo. Stock size. Triple radial groove. Super Alloy
F2433P	E	29.50 mm	5.96 mm	99.80 mm	4.98 mm	21° Taper Flo. Over size +1mm. Triple radial groove. Super Alloy
NOTE: The Exhaust valves feature a 1mm reduction stem in the tip area to allow the use of the OEM Factory rocker arm.						
TOYOTA GT86 2.0L - DOHC 16 VALVE (4U-GSE) EUROPE - 2012-2014						
F2356P	E	29mm	5.45mm	95.3mm	7.5mm	29° Flo. Stock size. Super Alloy
F2359P	E	30mm	5.45mm	95.3mm	7.5mm	29° Flo. +1mm oversize. Super Alloy

SPORT COMPACT APPLICATIONS

SUPER ALLOY VALVES

Part#	Type	Head Diam.	Stem Diam.	Overall Length	Tip Length	References
TOYOTA GT86 2.0L - DOHC 16 VALVE (4U-GSE) EUROPE - 2015						
F2378P	E	29mm	5.45mm	97.6mm	10.1mm	29° Flo. Flat Head. Stock. Super Alloy
F2380P	E	30mm	5.45mm	97.6mm	10.1mm	29° Flo. Flat Head. +1mm. Super Alloy
VW 2.0T FSI - DOHC 16 VALVE - 2006-2008						
VW 2.0T TSI - DOHC 16 VALVE - 2009-2013						
VW BEETLE/GOLF/JETTA/RABBIT 2.5L - DOHC 20 VALVE (BTW) - 2005 -1/2-2009						
VW GOLF R 2.0T TSI - DOHC 16 VALVE - 2015-2016						
F2177P	E	28 mm	5.97 mm	102 mm	5 mm	24° Flo. Stock size. Triple Groove. Super Alloy
F2178P	E	29 mm	5.97 mm	102 mm	5 mm	24° Flo. + 1 mm oversize. Triple Groove. Super Alloy
VW VR6 2.8L - DOHC 12 VALVE - 1992-2002						
F1921P	E	35 mm	6.96 mm	106.9 mm	2.25 mm	22° S. Flo. +1 mm o/size. Super Alloy. Turbo Appl.
F2135P	E	36 mm	6.96 mm	106.9 mm	2.25 mm	22° S. Flo. +2 mm o/size. Super Alloy. Turbo Appl.
VW VR6 R32 3.2L - DOHC 24 VALVE 2004-2011						
F2288P	E	30.20 mm	5.96 mm	136.48 mm	4.6 mm	25° Taper Flo. Stock size. Super Alloy.
F2289P	E	30.20 mm	5.96 mm	102.58 mm	4.6 mm	25° Taper Flo. Stock size. Super Alloy.
F2290P	E	31.20 mm	5.96 mm	136.48 mm	4.6 mm	25° Taper Flo. +1 mm oversize. Super Alloy.
F2291P	E	31.20 mm	5.96 mm	102.58 mm	4.6 mm	25° Taper Flo. +1 mm oversize. Super Alloy.

SUPER ALLOY VALVES - BLANKS

Part#	Type	Head Diam.	Stem Diam.	Overall Length	Tip Length	References
BLANKS (4-5 mm) ("REQUIRE LASH CAPS or HARD TIPS")						
F0069	E	34mm	4.97mm	140mm	BLANK	19° Flo. Super Alloy
BLANKS (5-6 mm) ("REQUIRE LASH CAPS or HARD TIPS")						
F2415P	E	34 mm	5.46mm	145mm	BLANK	25° Taper Flo. Super Alloy
F1943P	E	32mm	5.48mm	140mm	BLANK	22° Flo. Super Alloy Turbo Applications
F1942P	E	34mm	5.95mm	140mm	BLANK	21° Flo. Super Alloy Turbo Applications
F1996P	E	38mm	5.975mm	150 mm	BLANK	21° Tulip Taper Flo. Dish Head. Super Alloy
BLANKS (6-7 mm) ("REQUIRE LASH CAPS or HARD TIPS")						
F1941P	E	32.5mm	6.55mm	140mm	BLANK	22° Flo. Super Alloy Turbo Applications
BLANKS (7-8 mm) ("REQUIRE LASH CAPS or HARD TIPS")						
F0345	E	33mm	7mm	135mm	BLANK	22.5° Tulip Flo. Super Alloy
F0346	E	39mm	7mm	135mm	BLANK	22.5° Tulip Flo. Dish Head. Super Alloy

COMPETITION PLUS VALVES

Part#	Type	Head Diam.	Stem Diam.	Overall Length	Tip Length	References
ACURA INTEGRA GSR 1.7L - DOHC VTEC 16 VALVE (B17A1) - 1992-1993						
ACURA INTEGRA GSR 1.8L - DOHC VTEC 16 VALVE (B18C1-C3) - 1994-2000						
F1449P	E	28 mm	5.45 mm	102.5 mm	2.5 mm	25° Flo Stock size. Super Alloy
F1447P	E	28.5 mm	5.45 mm	102.5 mm	2.5 mm	25° Flo - .5 mm oversize. Super Alloy
F1445P	E	29 mm	5.45 mm	102.5 mm	2.5 mm	25° Flo - 1 mm oversize. Super Alloy
F1448P	I	33 mm	5.47 mm	102.35 mm	2.5 mm	25° Super Flo. Stock size
F1446P	I	33.5mm	5.47 mm	102.35 mm	2.5 mm	25° Super Flo - .5 mm oversize
F1444P	I	34 mm	5.47 mm	102.35 mm	2.5 mm	25° Super Flo - 1 mm oversize
ACURA INTEGRA LS-GS 1.8L - DOHC 16 VALVE (B18A1-B1) - 1990-2000						
F1815P	E	28 mm	6.54 mm	106.02 mm	4.1 mm	30° Flo Dish Head - Stock size. Super Alloy
F1488P	E	28.5 mm	6.54 mm	106.02 mm	4.1 mm	30° Flo Dish Head - .5mm oversize. Super Alloy
F1489P	E	29 mm	6.54 mm	106.02 mm	4.1 mm	30° Flo Dish Head - 1mm oversize. Super Alloy
F1816P	I	31 mm	6.57 mm	105.5 mm	4.1 mm	20° Super Flo Dish Head - Stock size
F1490P	I	31.5 mm	6.57 mm	105.5 mm	4.1 mm	20° Super Flo Dish Head - .5mm oversize
F1491P	I	32 mm	6.57 mm	105.5 mm	4.1 mm	20° Super Flo Dish Head - 1mm oversize
ACURA NSX 3.2L - DOHC 24 VALVE (C32B) - 1997-2005						
F1559P	E	30.05 mm	5.455 mm	111.6 mm	3.17 mm	30° Flo. Stock size
F1561P	E	31.05 mm	5.455 mm	111.6 mm	3.17 mm	30° Flo. +1mm oversize
F1558P	I	35.97 mm	5.48 mm	112.37 mm	3.25 mm	20° Super Flo. Stock size
F1560P	I	37 mm	5.48 mm	112.37 mm	3.25 mm	20° Super Flo. +1mm oversize
ACURA RSX 2.0L - DOHC VTEC 16 VALVE (K20) - 2001-2006						
F1546P	E	30 mm	5.45 mm	109.15 mm	2.5 mm	30° Flo. Dish Head. Stock size. Special Alloy
F1547P	E	31 mm	5.45 mm	109.15 mm	2.5 mm	30° Flo. Dish Head. +1 mm oversize. Special Alloy
F1548P	I	35 mm	5.47 mm	109.30 mm	2.5 mm	20° Super Flo. Stock size
F1549P	I	36 mm	5.47 mm	109.30 mm	2.5 mm	20° Super Flo. +1 mm oversize
ACURA TSX 2.4L - DOHC i-VTEC 16 VALVE (K24Z3) - 2009-2014						
ACURA ILX 2.4L - DOHC i-VTEC 16 VALVE (K24Z7) - 2013-2015						
F2389P	E	31 mm	5.45 mm	109.3 mm	2.1 mm	25° Flo. Stock size. Super Alloy
F2391P	E	32 mm	5.45 mm	109.3 mm	2.1 mm	25° Flo. 1 mm oversize. Super Alloy
F2388P	I	36 mm	5.47 mm	109.15 mm	2.1 mm	15° Super Flo. Stock size.
F2390P	I	37 mm	5.47 mm	109.15 mm	2.1 mm	15° Super Flo. +1 mm oversize.

COMPETITION PLUS VALVES

Part#	Type	Head Diam.	Stem Diam.	Overall Length	Tip Length	References
AUDI 1.8T - DOHC 20 VALVE - 1996-2005						
AUDI 2.7T - DOHC 30 VALVE (APB) 1998-2004						
AUDI RS6 4.2L - DOHC V8 40 VALVE (BCY) - 2002-2004						
F1554P	E	29.9 mm	5.96 mm	103.92 mm	5 mm	26° Flo. Stk size. Trip. groove. 2 Valves required
F1555P	E	30.9 mm	5.96 mm	103.92 mm	5 mm	26° Flo. +1 mm o/s. Trip. groove. 2 Valves required
F1556P	I	26.9 mm	5.97 mm	105.1 mm	5 mm	24° Sup. Flo. Stk size. Trip. groove. 3 Val. required
F1557P	I	27.9 mm	5.97 mm	105.1 mm	5 mm	24° Sup. Flo. +1 mm o/s. Trip. groove. 3 Val. required
AUDI 2.0T FSI - DOHC 16 VALVE - 2006-2008						
AUDI 2.0T TFSI - DOHC 16 VALVE - 2009-2013						
F2177P	E	28mm	5.97 mm	102 mm	5 mm	24° Flo. Stock Size. Triple Groove. Super Alloy
F2178P	E	29mm	5.97 mm	102 mm	5 mm	24° Flo. + 1 mm oversize. Triple Groove. Super Alloy
F2179P	I	33.9 mm	5.98 mm	104 mm	5 mm	20° Super Flo. Stock Size. Triple Groove
F2180P	I	34.9 mm	5.98 mm	104 mm	5 mm	20° Super Flo. + 1 mm oversize. Triple Groove
AUDI TTRS / RS3 2.5L TFSI - DOHC 20 VALVE (DAZA) TURBO - 2017-2018						
F2417P	E	28mm	5.97 mm	102 mm	5 mm	24° Flo. Stock Size. Triple Groove. Super Alloy
F2418P	E	29mm	5.97 mm	102 mm	5 mm	24° Flo. +1 mm oversize. Triple Groove. Super Alloy
F2419P	I	33.9 mm	5.98 mm	104 mm	5 mm	20° Super Flo. Stock Size. Triple Groove
F2420P	I	34.9 mm	5.98 mm	104 mm	5 mm	20° Super Flo. +1 mm oversize. Triple groove
BMW E36 3.2L - DOHC 24 VALVE (S42 / M42 / M50/ S50 / M52 / M54) - 1990-2000						
F1552P	E	30.5 mm	5.96 mm	106 mm	3.7 mm	25° Flo. Stock size. Triple groove
F1553P	E	31.5 mm	5.96 mm	106 mm	3.7 mm	25° Flo. + 1 mm o/size. Triple groove
F1550P	I	32.95 mm	5.97 mm	106.1 mm	3.7 mm	12° Super Flo. Stock size. Triple groove
F1551P	I	33.95 mm	5.97 mm	106.1 mm	3.7 mm	12° Super Flo. + 1 mm o/size. Triple groove
BMW E46 3.2L - DOHC 24 VALVE (S54) - 2001-2006						
F2360P	E	30.5 mm	5.96 mm	119.2 mm	1.1 mm	30° Taper Flo. Stk size. Triple radial groove. Super Alloy
F2361P	I	35 mm	5.98 mm	117.6 mm	1.2 mm	19° Super Flo. Stk size. 30° Backcut. Triple radial groove.
BMW E60/E82/E91/E92 3.0L - DOHC 24 VALVE (N54) - 2007-2010						
F2365P	E	28 mm	5.96 mm	114.75 mm	4.7 mm	19° Taper Flo. Stk size. Triple radial groove. Super Alloy
F2366P	E	28.5 mm	5.96 mm	114.75 mm	4.7 mm	19° Taper Flo. +.5mm oversize. Triple radial groove. Super Alloy
F2367P	I	31.5 mm	4.97 mm	106.8 mm	4.2 mm	24° Taper Flo. Stock size. Triple Groove.
F2368P	I	32 mm	4.97 mm	106.8 mm	4.2 mm	24° Taper Flo. +.5mm oversize. Triple radial groove.
NOTE: The Exhaust valves feature a 1mm reduction stem in the tip area to allow the use of the OEM Factory rocker arm.						
BMW M3/M4 3.0L - DOHC 24 VALVE (S55) TWIN TURBO - 2015-2019						
F2428P	E	28.0 mm	5.96 mm	112.83 mm	5.20 mm	21° Taper Flo. Stock size. Triple radial groove. Super Alloy
F2429P	I	32.0 mm	4.97 mm	104.90 mm	4.45 mm	12° Taper Flo. Stock size. Triple radial groove.
NOTE: The Exhaust valves feature a 1mm reduction stem in the tip area to allow the use of the OEM Factory rocker arm.						
DODGE NEON 2.0 - DOHC 16 VALVE - 1994-1999						
F1544P	E	30.5 mm	5.9 mm	109.80 mm	11 mm	24° Tulip. Stock Size
F1545P	I	34.75 mm	5.93 mm	111.75 mm	11 mm	14° Super Flo. Stock size
DODGE NEON 2.4 - SRT4 - DOHC 16 VALVE (A853) - 2003-2005						
F2141P	E	28.36 mm	5.95 mm	109.80 mm	9.1 mm	21° Flo. Stock size. Super Alloy. Turbo Appl. Single Groove
F2142P	E	29.36 mm	5.95 mm	109.80 mm	9.1 mm	21° Flo. 1mm O/Size Super Alloy. Turbo Appl. Single Groove
F2143P	I	34.81 mm	5.96 mm	111.7 mm	11.05 mm	21° Super Flo. Stock size. Single Groove
F2144P	I	35.81 mm	5.96 mm	111.7 mm	11.05 mm	21° Super Flo. + 1mm oversize. Stock Size. Single Groove
Tech Note: These Ferrea Racing Valves come with single radial grooves. For racing applications Ferrea Racing does not recommend the use of triple radial grooved valves. These valves are designed to be used only with Ferrea Valve Train Kit components.						
FORD ESCORT 2.0L - DOHC ZETEC 16 VALVE (ZX2) - 1999-2001						
FORD FOCUS 2.0L - DOHC ZETEC 16 VALVE (ZX3) - 2000-2001						
F1817P	E	27.96 mm	6.012 mm	97.16 mm	5.25 mm	25° Flo. Stock size. Super Alloy
F1818P	E	28.96 mm	6.012 mm	97.16 mm	5.25 mm	25° Flo. 1 mm oversize. Super Alloy
F1959P	E	28.96 mm	5.5 mm	97.16 mm	5.25 mm	25° Flo. 1 mm oversize. Super Alloy
F1819P	I	32 mm	6.03 mm	97.55 mm	5.25 mm	25° Super Flo. Stock size
F1820P	I	33 mm	6.03 mm	97.55 mm	5.25 mm	25° Super Flo. 1 mm oversize
F1960P	I	33 mm	5.5 mm	97.55 mm	5.25 mm	25° Super Flo. 1 mm oversize
FORD 2.3L - DOHC DURATEC 16VALVE (23E) - 2003-2008						
F1910P	E	29.96 mm	5.47 mm	104.78 mm	4 mm	20° Flo. Stock size. Super Alloy
F1911P	E	30.96 mm	5.47 mm	104.78 mm	4 mm	20° Flo. 1 mm oversize. Super Alloy
F1908P	I	35.08 mm	5.48 mm	103.6 mm	4 mm	20° Super Flo. Stock size
F1909P	I	36.08 mm	5.48 mm	103.6 mm	4 mm	20° Super Flo. 1 mm oversize
FORD ECOBOOST 2.3L - DOHC 16 VALVE - 2015						
F2370P	E	30mm	5.46mm	104.75mm	3.75mm	25° Taper Flo. Stock. Super Alloy
F2371P	E	30.5mm	5.46mm	104.75mm	3.75mm	25° Taper Flo. +.5mm Oversize. Super Alloy
F2374P	I	32.5mm	5.47mm	103.55mm	4 mm	22° Super Flo. Stock.
F2375P	I	33mm	5.47mm	103.55mm	4mm	22° Super Flo. +.5mm Oversize.
GM 2.2 ECO TEC - 2000-2008						
F1961P	E	30.1 mm	5.96 mm	101.5 mm	5.5 mm	22° Flo. Stock size
F1962P	E	31.1 mm	5.96 mm	101.5 mm	5.5 mm	22° Flo. 1 mm oversize
F1963P	I	35.1 mm	5.97 mm	102.5 mm	5.5 mm	20° Super Flo. Stock size
F1964P	I	36.1 mm	5.97 mm	102.5 mm	5.5 mm	20° Super Flo. + 1 mm oversize
GM 5 CYLINDER - L5 - 2002-2006						
F1948P	E	30.15 mm	5.96 mm	108 mm	5.5 mm	22° Flo. Stock size
F1949P	E	31.15 mm	5.96 mm	108 mm	5.5 mm	22° Flo. 1 mm oversize
F1950P	I	37 mm	5.97 mm	105.5 mm	5.5 mm	20° Super Flo. Stock size
F1951P	I	38 mm	5.97 mm	105.5 mm	5.5 mm	20° Super Flo. 1 mm oversize

COMPETITION PLUS VALVES

Part#	Type	Head Diam.	Stem Diam.	Overall Length	Tip Length	References
HONDA ACCORD LX 2.4L - DOHC i-VTEC 16 VALVE (K24Z2) - 2008-2012						
HONDA CIVIC Si 2.4L - DOHC i-VTEC 16 VALVE (K24Z7) - 2012-2015						
F2389P	E	31 mm	5.45 mm	109.3 mm	2.1 mm	25° Flo. Stock size. Super Alloy
F2391P	E	32 mm	5.45 mm	109.3 mm	2.1 mm	25° Flo. 1 mm oversize. Super Alloy
F2388P	I	36 mm	5.47 mm	109.15 mm	2.1 mm	15° Super Flo. Stock size.
F2390P	I	37 mm	5.47 mm	109.15 mm	2.1 mm	15° Super Flo. +1 mm oversize.
HONDA CIVIC CRX SI 1.6L - SOHC 16 VALVE (D16A6) - 1988-1991						
F1857P	E	25 mm	5.5 mm	118.75 mm	4.35 mm	25° Flo. Stock size. Super Alloy
F1858P	E	26 mm	5.5 mm	118.75 mm	4.35 mm	25° Flo. 1 mm oversize. Super Alloy
F1855P	I	29 mm	5.5 mm	115 mm	4.1 mm	25° Super Flo. Stock size
F1856P	I	30 mm	5.5 mm	115 mm	4.1 mm	25° Super Flo. 1 mm oversize
HONDA CIVIC 1.6L - SOHC 16 VALVE (D16Z6-Y5-Y7-Y8) - 1992-2000						
F1821P	E	26 mm	5.46 mm	115.95 mm	1.9 mm	22° Flo. Stock size. Super Alloy
F1495P	E	27 mm	5.46 mm	115.95 mm	1.9 mm	22° Flo. 1 mm oversize. Super Alloy
F1822P	I	30 mm	5.48 mm	118.6 mm	1.9 mm	20° Super Flo. Stock size
F1494P	I	31 mm	5.48 mm	118.6 mm	1.9 mm	20° Super Flo. 1 mm oversize
HONDA DEL SOL 1.6L - DOHC VTEC 16 VALVE (B16A1) - 1994-1997						
HONDA CIVIC SI 1.6L - DOHC VTEC 16 VALVE (B16A3) - 1999-2000						
F1449P	E	28 mm	5.45 mm	102.5 mm	2.5 mm	25° Flo Stock size. Super Alloy
F1447P	E	28.5 mm	5.45 mm	102.5 mm	2.5 mm	25° Flo - .5 mm oversize. Super Alloy
F1445P	E	29 mm	5.45 mm	102.5 mm	2.5 mm	25° Flo - 1 mm oversize. Super Alloy
F1448P	I	33 mm	5.47 mm	102.35 mm	2.5 mm	25° Super Flo. Stock size
F1446P	I	33.5 mm	5.47 mm	102.35 mm	2.5 mm	25° Super Flo - .5 mm oversize
F1444P	I	34 mm	5.47 mm	102.35 mm	2.5 mm	25° Super Flo - 1 mm oversize
HONDA CRV 2.0L - DOHC 16 VALVE (B20A-B20Z) - 1997-2000						
F1815P	E	28 mm	6.54 mm	106.02 mm	4.1 mm	30° Flo Dish Head - Stock soze. Super Alloy
F1488P	E	28.5 mm	6.54 mm	106.02 mm	4.1 mm	30° Flo Dish Head - .5 mm oversize. Super Alloy
F1489P	E	29 mm	6.54 mm	106.02 mm	4.1 mm	30° Flo Dish Head - 1 mm oversize. Super Alloy
F1816P	I	31 mm	6.57 mm	105.5 mm	4.1 mm	20° Super Flo Dish Head - Stock soze
F1490P	I	31.5 mm	6.57 mm	105.5 mm	4.1 mm	20° Super Flo Dish Head - .5 mm oversize
F1491P	I	32 mm	6.57 mm	105.5 mm	4.1 mm	20° Super Flo Dish Head - 1 mm oversize
HONDA CIVIC TYPE-R 2.0L - DOHC VTEC 16 VALVE (K20C1-TURBO) - 2017-2018						
F2394P	E	29 mm	5.47 mm	114.75 mm	2.1 mm	28° Taper Flo. Stock size. Super Alloy
F2395P	E	30 mm	5.47 mm	114.75 mm	2.1 mm	28° Taper Flo. +1 mm oversize. Super Alloy
F2396P	I	35 mm	5.48 mm	117.25 mm	2.1 mm	20° Super Flo. Stock size. Special Alloy
F2397P	I	36 mm	5.48 mm	117.25 mm	2.1 mm	20° Super Flo. +1 mm oversize. Special Alloy
HONDA PRELUDE 2.2L - DOHC VTEC 16 VALVE (H22A1-A4) - 1993-2000						
F1823P	E	30 mm	5.48 mm	107.1 mm	1.9 mm	22° Flo. Stock size. Super Alloy
F1958P	E	30.5 mm	5.48 mm	107.1 mm	1.9 mm	22° Flo - .5 mm oversize. Super Alloy
F1458P	E	31 mm	5.48 mm	107.1 mm	1.9 mm	22° Flo. 1 mm oversize. Super Alloy
F1824P	I	35 mm	5.48 mm	106.85 mm	1.9 mm	20° Super Flo. Stock size
F1956P	I	35.5 mm	5.48 mm	106.85 mm	1.9 mm	20° Super Flo - .5 mm oversize
F1456P	I	36 mm	5.48 mm	106.85 mm	1.9 mm	20° Super Flo. 1 mm oversize
HONDA S 2000 - F20C - 2000-2003						
HONDA S 2000 - F22C - 2004-2008						
F1952P	E	31 mm	5.46 mm	109 mm	2.5 mm	22° Flo. Stock size
F1953P	E	32 mm	5.46 mm	109 mm	2.5 mm	22° Flo. +1mm o/size
F1954P	I	36 mm	5.48 mm	109.8 mm	2.5 mm	20° Super Flo. Stock size
F1955P	I	37 mm	5.48 mm	109.8 mm	2.5 mm	20° Super Flo. +1mm o/size
HYUNDAI GENESIS 2.0L - DOHC 16 VALVE (TURBO BK) - 2008-2010						
F2181P	E	29 mm	5.46 mm	105.90 mm	2.32 mm	25° Flo. Stock size. Single Groove. Super Alloy
F2174P	E	30 mm	5.46 mm	105.90 mm	2.32 mm	25° Flo. + 1 mm oversize. Single Groove. Super Alloy
F2175P	I	35 mm	5.47 mm	113.25 mm	4.24 mm	15° Super Flo. Stock size. Single Groove.
F2176P	I	36 mm	5.47 mm	113.25 mm	4.24 mm	15° Super Flo. + 1 mm oversize. Single Groove.
HYUNDAI GENESIS COUPE V-6 3.8L - DOHC 24 VALVE (LAMBDA) - 2010						
F2238P	E	31.00mm	5.46mm	105.50mm	2.00mm	20° Flo. Single Radial Gro. Stock size. Special Alloy
F2239P	E	32.00mm	5.46mm	105.50mm	2.00mm	20° Flo. Single Radial Gro. +1 mm. Special Alloy
F2240P	I	36.00mm	5.47mm	105.25mm	2.00mm	12° Super Flo. Single Radial Gro. Stock size. Special Alloy
F2241P	I	37.00mm	5.47mm	105.25mm	2.00mm	12° Super Flo. Single Radial Gro. +1 mm. Special Alloy
INFINITI V6 3.0L - DOHC 24 VALVE (VR30DDTT) - 2015-2018						
F2411P	E	28.50mm	5.46mm	97.50mm	8.5mm	25° Taper Flo. Stock size. Super Alloy
F2412P	E	29.50mm	5.46mm	97.50mm	8.5mm	25° Taper Flo. +1mm Over size. Super Alloy
F2413P	I	33.35mm	5.47mm	101.10mm	4.5mm	24° Super Flo. Stock size. Special Alloy
F2414P	I	34.35mm	5.47mm	101.10mm	4.5mm	24° Super Flo. +1mm Over size. Special Alloy
LAMBORGHINI V10 5.0L - DOHC 40 VALVE - 2003-2007						
F2284P	E	28 mm	5.97 mm	102 mm	5 mm	24° Flo. Stock size. Triple Groove. Super Alloy
F2286P	I	33.9 mm	5.98 mm	104 mm	5 mm	20° Super Flo. Stock size. Triple Groove
LOTUS ELISE / EXIGE 1.8L - DOHC 16 VALVE (ZZZ-GE) - 2008						
F2190P	E	29 mm	5.45 mm	111.8 mm	5.4 mm	25° Super Flo. Stock size. Single Groove. Super Alloy
F2191P	E	30 mm	5.45 mm	111.8 mm	5.4 mm	25° Super Flo. + 1 mm oversize. Single Groove. Super Alloy
F2192P	I	34 mm	5.46 mm	111.45 mm	5.4 mm	9° Super Flo. Stock size. Single Groove
F2193P	I	35 mm	5.46 mm	111.45 mm	5.4 mm	9° Super Flo. + 1 mm oversize. Single Groove

COMPETITION PLUS VALVES

Part#	Type	Head Diam.	Stem Diam.	Overall Length	Tip Length	References
MITSUBISHI 3000 GT 3.0L - DOHC 24 VALVES (6G72-TURBO 6G72T) - 1990-2001						
F1853P	E	30.5 mm	6.55 mm	105.5 mm	3.8 mm	25° Flo. Stock size. Super Alloy
F1854P	E	31.5 mm	6.55 mm	105.5 mm	3.8 mm	25° Flo. + 1 mm oversize. Super Alloy
F1851P	I	35 mm	6.57 mm	106.35 mm	3.8 mm	25° Super Flo. Stock Size
F1852P	I	36 mm	6.57 mm	106.35 mm	3.8 mm	25° Super Flo. + 1 mm oversize
MITSUBISHI ECLIPSE GS-GST 2.0L - DOHC 16 VALVE (4G63-4G63T) - 1990-1999						
F1825P	E	30.5 mm	6.55 mm	109.7 mm	3.8 mm	22° Flo. Stock size. Super Alloy
F1454P	E	31.5 mm	6.55 mm	109.7 mm	3.8 mm	20° Flo. + 1 mm oversize. Super Alloy
F1826P	I	34 mm	6.57 mm	109.7 mm	3.8 mm	20° Super Flo. Stock size
F1452P	I	35 mm	6.57 mm	109.7 mm	3.8 mm	20° Super Flo. + 1 mm oversize
MITSUBISHI EVOLUTION VIII 2.0L - DOHC 16 VALVE (TURBO 4G63T) - 2003-2007						
F1825P	E	30.5 mm	6.55 mm	109.7 mm	3.8 mm	22° Flo. Stock size
F1454P	E	31.5 mm	6.55 mm	109.7 mm	3.8 mm	22° Flo. + 1 mm oversize
F1826P	I	34 mm	6.57 mm	109.7 mm	3.8 mm	20° Super Flo. Stock Size
F1452P	I	35 mm	6.57 mm	109.7 mm	3.8 mm	20° Super Flo. + 1 mm oversize
MITSUBISHI EVOLUTION X 2.0L - DOHC 16 VALVE (4B11T) - 2007-2009						
F2181P	E	29 mm	5.46 mm	105.90 mm	2.32 mm	25° Flo. Stock size. Single Groove. Super Alloy
F2174P	E	30 mm	5.46 mm	105.90 mm	2.32 mm	25° Flo. + 1 mm oversize. Single Groove. Super Alloy
F2175P	I	35 mm	5.47 mm	113.25 mm	4.24 mm	15° Super Flo. Stock size. Single Groove.
F2176P	I	36 mm	5.47 mm	113.25 mm	4.24 mm	15° Super Flo. + 1 mm oversize. Single Groove.
NISSAN 280 ZX 2.8I - SOHC 12 VALVE (L28E-TURBO L28ET) - 1981-1983						
F1841P	E	35 mm	8 mm	115.25 mm	3 mm	20° Flo. Stock size. Super Alloy
F1842P	E	36 mm	8 mm	115.25 mm	3 mm	20° Flo. + 1 mm oversize. Super Alloy
F1839P	I	44 mm	8 mm	114.3 mm	3 mm	20° Super Flo. Stock size
F1840P	I	45 mm	8 mm	114.3 mm	3 mm	20° Super Flo. + 1 mm oversize
NISSAN 300 ZX 3.0L - SOHC 12 VALVE (VG30D-TURBO VG30T) -1984-1989						
F1845P	E	35.1 mm	8 mm	124.5 mm	4.5 mm	20° Flo. Stock size. Super Alloy
F1846P	E	36.1 mm	8 mm	124.5 mm	4.5 mm	20° Flo. + 1 mm oversize. Super Alloy
F1843P	I	42 mm	7 mm	125.85 mm	4.5 mm	20° Super Flo. Stock size
F1844P	I	43 mm	7 mm	125.85 mm	4.5 mm	20° Super Flo. + 1 mm oversize
NISSAN 300 ZX 3.0L - DOHC 24 VALVE (VG30D-TURBO VG30DTT) - 1990-1996						
F1849P	E	29.5 mm	6 mm	103.65 mm	3.5 mm	25° Flo. Stock size. Super Alloy
F1850P	E	30.5 mm	6 mm	103.65 mm	3.5 mm	25° Flo. + 1 mm oversize. Super Alloy
F1847P	I	34 mm	6 mm	103.13 mm	3.5 mm	25° Super Flo. Stock size
F1848P	I	35 mm	6 mm	103.13 mm	3.5 mm	25° Super Flo. + 1 mm oversize
NISSAN 350 Z 3.5 L - V-6 - DOHC 24 VALVE (VQ35) - 2003-2008						
F1564P	E	31.35 mm	5.96 mm	94.40 mm	3.5 mm	22° Flo. Radial Groove. Stock size. Special Alloy
F1565P	E	32.35 mm	5.96 mm	94.40 mm	3.5 mm	22° Flo. + 1mm oversize. Radial Gro. Super Alloy. Turbo Appl.
F1562P	I	37.15 mm	5.97 mm	96.70 mm	3.5 mm	20° Super Flo. Stock size. Radial Groove. Special Alloy
F1563P	I	38.15 mm	5.97 mm	96.70 mm	3.5 mm	20° Super Flo. + 1 mm oversize. Radial Gro. Special Alloy
NISSAN ALTIMA 2.4L - DOHC 16 VALVE (KA24DE) - 1995-1999						
NISSAN 240 SX 2.4L - DOHC 16 VALVE (KA24DE) - 1991-1998						
F1837P	E	31.3 mm	7 mm	98.85 mm	4.5 mm	25° Flo. Stock size. Super Alloy
F1838P	E	32.3 mm	7 mm	98.85 mm	4.5 mm	25° Flo. + 1 mm oversize. Super Alloy
F1835P	I	36.6 mm	7 mm	101.32 mm	4.5 mm	25° Super Flo. Stock Size
F1836P	I	37.6 mm	7 mm	101.32 mm	4.5 mm	25° Super Flo. + 1 mm oversize
NISSAN GT-R 3.8 L V-6 - DOHC 24 VALVE (VR38DETT) - 2009-2010						
F2234P	E	32.2 mm	5.97 mm	92 mm	2.1 mm	24° Taper Flo. Stock size. Super Alloy. Turbo Application
F2235P	E	33.2 mm	5.97 mm	92 mm	2.1 mm	24° Taper Flo. + 1mm o/size. Super Alloy. Turbo Application
F2236P	I	37 mm	5.98 mm	95 mm	4.8 mm	22° Super Flo. Stock size. Special Alloy.
F2237P	I	38 mm	5.98 mm	95 mm	4.8 mm	22° Super Flo. + 1mm o/size. Special Alloy.
TECH NOTE: Both, Exhaust and Intake Valves, feature a .5 mm reduction stem in the groove area.						
NISSAN PATROL 4.5L 6 CYL IN LINE - 12 VALVE - (TB45E) -1997-2004						
F2225P	E	38.1 mm	7.94 mm	118.8 mm	5 mm	25° Taper Flo. Stock size. Square Groove. Special Alloy
F2226P	E	39.1 mm	7.94 mm	118.8 mm	5 mm	25° Taper Flo. +1mm o/size. Square Groove. Special Alloy
F2227P	I	47 mm	7.94 mm	118.15 mm	5 mm	15° Super Flo. Stock size. Square Groove
F2228P	I	48 mm	7.94 mm	118.15 mm	5 mm	15° Super Flo. + 1mm o/size. Square Groove
NISSAN PATROL 4.8L 6 CYL IN LINE - 24 VALVE - (TB48DE) - 2004-2010						
F2153P	E	33.5 mm	6.96 mm	98.3 mm	3.5 mm	20° Flo. Stock size. Super Alloy. Turbo Appl.
F2154P	E	34.5 mm	6.96 mm	98.3 mm	3.5 mm	20° Flo. + 1 mm oversize. Super Alloy. Turbo Appl.
F2166P	E	35 mm	6.96 mm	98.3 mm	3.5 mm	20° Flo. + 1.5 mm oversize. Super Alloy. Turbo Appl.
F2155P	I	38.5 mm	6.96 mm	100.02 mm	3.5 mm	12° Super Flo. Stock size. Special Alloy
F2156P	I	39.5 mm	6.96 mm	100.02 mm	3.5 mm	12° Super Flo. + 1 mm oversize. Special Alloy
F2167P	I	40 mm	6.96 mm	100.02 mm	3.5 mm	12° Super Flo. + 1.5 mm oversize. Special Alloy
Tech Note: Both Exhaust and Intake Valves feature a 1 mm reduction stem in the groove area to allow the use of the same springs, retainers and locks.						
NISSAN SENTRA SE-R 2.0L - DOHC 16 VALVE (SR20DE) - 1991-1998						
F1869P	E	30.15 mm	5.94 mm	102.4 mm	3.5 mm	22° Flo. Stock size. Super Alloy
F1870P	E	31.15 mm	5.94 mm	102.4 mm	3.5 mm	22° Flo. 1 mm oversize. Super Alloy
F1867P	I	34.15 mm	5.96 mm	101.4 mm	3.5 mm	20° Super Flo. Stock size
F1868P	I	35.15 mm	5.96 mm	101.4 mm	3.5 mm	20° Super Flo. 1 mm oversize

SPORT COMPACT APPLICATIONS

COMPETITION PLUS VALVES

Part#	Type	Head Diam.	Stem Diam.	Overall Length	Tip Length	References
-------	------	------------	------------	----------------	------------	------------

NISSAN SENTRA SE-R 2.0L - DOHC 16 VALVE (SR20DET) 1991-1998

F2129P	E	30.15 mm	6.95 mm	102.4 mm	3.5 mm	22° Flo.Radial Groove.Stock.Super Alloy.Turbo appl.
F2130P	E	31.15 mm	6.95 mm	102.4 mm	3.5 mm	22° Flo.Radial Groove+1mm o/size.Super Alloy.Turbo appl.
F1867P	I	34.15 mm	5.96 mm	101.4 mm	3.5 mm	20° Super Flo. Radial Gro. Stock Size
F1868P	I	35.15 mm	5.96 mm	101.4 mm	3.5 mm	20° Super Flo. Radial Gro.+ 1 mm oversize

(*) Both Exhaust Valves feature a 1 mm reduction stem in the groove area to allow the use of the same springs, retainers and valve locks used in the Intake Valves.

NISSAN SKYLINE 6 CYL IN LINE - 24 VALVE - (RB26) - 1989-2002

F2131P	E	30.15mm	6.9mm	101.52mm	3.5mm	22° Flo. Radial Gro. Stock. Super Alloy Turbo appl.
F2132P	E	31.15mm	6.9mm	101.52mm	3.5mm	22° Flo. Radial Gro. + 1mm o/size.Super Alloy Turbo appl.
F2133P	I	34.6mm	5.98mm	102.33mm	3.5mm	20° Super Flo. Radial Groove. Stock. Special Alloy
F2134P	I	35.6mm	5.98mm	102.33mm	3.5mm	20° Super Flo. Radial Gro. + 1mm o/size. Special Alloy

(*) Both Exhaust Valves feature a 1 mm reduction stem in the groove area to allow the use of the same springs, retainers and valve locks used in the Intake Valves.

NISSAN SKYLINE 6 CYL IN LINE - 24 VALVE - (RB25DET) - 1993-1997

F2149P	E	29.6 mm	5.96 mm	88.95 mm	3.2 mm	21° Flo. Stock size. Super Alloy. Turbo Applications
F2150P	E	30.6 mm	5.96 mm	88.95 mm	3.2 mm	21° Flo. +1 mm o/s. Super Alloy. Turbo Applications
F2151P	I	34.12 mm	5.97 mm	86.7 mm	3.5 mm	15° Super Flo. Stock size. Special Alloy
F2152P	I	35.12 mm	5.97 mm	86.7 mm	3.5 mm	15° Super Flo. +1 mm o/s. Special Alloy

NISSAN SKYLINE 6 CYL IN LINE - 24 VALVE - (NEO) - 1998-2002

F1935P	E	29.65 mm	5.96 mm	97.95 mm	3.7 mm	22° Flo. Stock size.
F1936P	E	30.65 mm	5.96 mm	97.95 mm	3.7 mm	22° Flo. + 1 mm oversize.
F1933P	I	34.15 mm	5.98 mm	104.2 mm	6.25 mm	20° Super Flo. Stock size.
F1934P	I	35.15 mm	5.98 mm	104.2 mm	6.25 mm	20° Super Flo. + 1 mm oversize.

PORSCHE 944 I4 2.5L - SOHC 8 VALVE (M44.X) - 1983-1987

F2298P	E	40mm	8.96mm	112.3mm	5mm	25° Taper Flo. Stock size. Special Alloy. Triple Groove
F2299P	I	46mm	8.98mm	111.6mm	5mm	20° Super Flo. +1mm Oversize. Triple Groov

PORSCHE 996TT 3.6L - FLAT 6 CYL - DOHC 24 VALVE - 2000-2005

F2271P	E	32 mm	5.95 mm	109.1 mm	3.7 mm	21° Flo. Stock size. Single radial groove. Super Alloy
F2272P	E	33 mm	5.95 mm	109.1 mm	3.7 mm	21° Flo. Oversize. Single radial groove. Super Alloy
F2273P	I	37 mm	5.97 mm	104.2 mm	8.4 mm	19° Super Flo. Stock size. Single radial groove
F2274P	I	38 mm	5.97 mm	104.2 mm	8.4 mm	19° Super Flo. Oversize. Single radial groove

Tech Note: These Ferrea Racing Valves come with single radial grooves. For racing applications, Ferrea does not recommend the use of triple radial grooved valves. These valves are designed to be used only with Ferrea Valve Train Kit components.

Ferrea offers Triple Radial Groove OEM design valves through special custom orders only.

SCION tC 2.4L - DOHC 16 VALVE (2AZFE) - 2005

F2145P	E	29.45 mm	5.48 mm	101.22 mm	2.55 mm	22° Flo. Stock size. Super Alloy
F2146P	E	30.45 mm	5.48 mm	101.22 mm	2.55 mm	22° Flo. 1 mm oversize. Super Alloy
F2147P	I	34.00 mm	5.5 mm	101.85 mm	2.55 mm	19° S. Flo. Stock Size. Special Alloy
F2148P	I	35.00 mm	5.5 mm	101.85 mm	2.55 mm	19° S. Flo. 1 mm oversize. Special Alloy

SCION tC 2.5L - DOHC 16 VALVE (2ARFE) - 2011

F2276P	E	31 mm	5.47 mm	113 mm	5.5 mm	24° Flo. Stock size. Super Alloy.
F2277P	E	32 mm	5.47 mm	113 mm	5.5 mm	24° Flo. + 1 mm oversize. Super Alloy.
F2278P	I	36.5 mm	5.48 mm	104 mm	5.5 mm	12° S. Flo. Stock size. Special Alloy.
F2279P	I	37.5 mm	5.48 mm	104 mm	5.5 mm	12° S. Flo. + 1 mm oversize. Special Alloy.

SCION FR-S 2.0L - DOHC 16 VALVE (4U-GSE) - 2012-2014

F2356P	E	29mm	5.45mm	95.3mm	7.5mm	29° Flo. Flat head. Stock size. Super Alloy
F2359P	E	30mm	5.45mm	95.3mm	7.5mm	29° Flo. Flat head. +1mm oversize. Super Alloy
F2357P	I	35mm	5.46mm	103.45mm	6.5mm	10° Super Flo. Flat Head. Stock size
F2358P	I	36mm	5.46mm	103.45mm	6.5mm	10° Super Flo. Flat Head. +1mm oversize

SCION FR-S 2.0L - DOHC 16 VALVE (4U-GSE) - 2015

F2378P	E	29mm	5.45mm	97.6mm	10.1mm	29° Flo. Flat Head. Stock. Super Alloy
F2380P	E	30mm	5.45mm	97.6mm	10.1mm	29° Flo. Flat Head. +1mm. Super Alloy
F2379P	I	35mm	5.46mm	105mm	8.2mm	10° Super Flo. Flat Head. Stock. Special Alloy
F2381P	I	36mm	5.46mm	105mm	8.2mm	10° Super Flo. Flat Head. +1mm. Special Alloy

SUBARU WRX 2.0L - DOHC 16 VALVE (EJ20) - 2001-2008

F1968P	E	32 mm	5.96 mm	104.75 mm	3.5 mm	25° Flo. Stock size. Super Alloy
F1966P	E	33 mm	5.96 mm	104.75 mm	3.5 mm	25° Flo. + 1 mm oversize. Super Alloy
F1967P	I	36 mm	5.97 mm	104.44 mm	3.5 mm	19° Super Flo. Stock size.
F1965P	I	37 mm	5.97 mm	104.44 mm	3.5 mm	19° Super Flo. + 1 mm oversize

NOTE: These Ferrea Valves must be used with Ferrea Valve Locks # K10061.

SUBARU WRX 2.0L - DOHC 16 VALVE (STI) - 2004-2008

F1514P	E	32 mm	5.96 mm	104.75 mm	3.5 mm	25° Flo. Stock size. Super Alloy
F1519P	E	33 mm	5.96 mm	104.75 mm	3.5 mm	25° Flo. + 1 mm oversize. Super Alloy
F1520P	I	36 mm	5.97 mm	104.6 mm	3.5 mm	19° Super Flo. Stock size.
F1524P	I	37 mm	5.97 mm	104.6 mm	3.5 mm	19° Super Flo. + 1 mm oversize

NOTE: These Ferrea Valves must be used with Ferrea Valve Locks # K10074.

SUBARU BRZ 2.0L - DOHC 16 VALVE (FA20) - 2012-2014

F2356P	E	29mm	5.45mm	95.3mm	7.5mm	29° Flo. Flat head. Stock size. Super Alloy
F2359P	E	30mm	5.45mm	95.3mm	7.5mm	29° Flo. Flat head. +1mm oversize. Super Alloy
F2357P	I	35mm	5.46mm	103.45mm	6.5mm	10° Super Flo. Flat Head. Stock size
F2358P	I	36mm	5.46mm	103.45mm	6.5mm	10° Super Flo. Flat Head. +1mm oversize

COMPETITION PLUS VALVES

Part#	Type	Head Diam.	Stem Diam.	Overall Length	Tip Length	References
SUBARU BRZ 2.0L - DOHC 16 VALVE (FA20) - 2015						
F2378P	E	29mm	5.45mm	97.6mm	10.1mm	29° Flo. Flat Head. Stock. Super Alloy
F2380P	E	30mm	5.45mm	97.6mm	10.1mm	29° Flo. Flat Head. +1mm. Super Alloy
F2379P	I	35mm	5.46mm	105mm	8.2mm	10° Super Flo. Flat Head. Stock. Special Alloy
F2381P	I	36mm	5.46mm	105mm	8.2mm	10° Super Flo. Flat Head. +1mm. Special Alloy
TOYOTA 2TC-3TC-20R-22R						
F1435P	E	38 mm	8 mm	113.3 mm	4.6 mm	19° Super Flo-Toyota 20R
F1433P	E	39 mm	8 mm	108.9 mm	5 mm	19° Super Flo-Toyota 2TC-3TC
F1431P	E	39 mm	8 mm	112.2 mm	4.6 mm	19° Super Flo-Toyota 22R
F1434P	I	44 mm	8 mm	108.2 mm	5 mm	R. 8.3 mm Super Flo-Toyota 2TC-3TC
F1436P	I	45 mm	8 mm	115.4 mm	4.6 mm	R. 8.3 mm Super Flo-Toyota 20R
F1432P	I	47.1 mm	8 mm	113.4 mm	4.6 mm	R. 8.3 mm Super Flo-Toyota 22R
TOYOTA 4AG 1.6L 16 VALVE (ATLANTIC)- 1983-1989						
F1422P	E	27.5 mm	6 mm	99.75 mm	3.5 mm	28° Flo
F1421P	I	32 mm	6 mm	99.6 mm	3.5 mm	15° Flo
TOYOTA 1.8L - DOHC 16 VALVE (ZZZ-GE) - 2003-2006						
F2190P	E	29 mm	5.45 mm	111.8 mm	5.4 mm	25° Super Flo. Stock size. Single Groove. Super Alloy
F2191P	E	30 mm	5.45 mm	111.8 mm	5.4 mm	25° Super Flo. + 1 mm oversize. Single Groove. Super Alloy
F2192P	I	34 mm	5.46 mm	111.45 mm	5.4 mm	9° Super Flo. Stock size. Single Groove
F2193P	I	35 mm	5.46 mm	111.45 mm	5.4 mm	9° Super Flo. + 1 mm oversize. Single Groove
TOYOTA MR2 2.0L - DOHC 16 VALVE (TURBO 3SGTE) - 1990-1995						
F1865P	E	29 mm	5.97mm	99.65 mm	3.5 mm	25° Flo. Stock size. Super Alloy
F1866P	E	30 mm	5.97mm	99.65 mm	3.5 mm	25° Flo. 1 mm oversize. Super Alloy
F1863P	I	33.5 mm	5.98mm	100.70 mm	3.5 mm	25° Super Flo. Stock size
F1864P	I	34.5 mm	5.98mm	100.70 mm	3.5 mm	25° Super Flo. 1 mm oversize
TOYOTA FJ CRUISER V6 4L - DOHC 24 VALVE (1GR-FE) - 2006-2008						
F1286P	E	29.5 mm	5.46 mm	105.95 mm	2.25 mm	25° Taper Flo. Stock size. Single Groove. Super Alloy
F1287P	E	30.5 mm	5.46 mm	105.95 mm	2.25 mm	25° Taper Flo. + 1 mm oversize. Single Groove. Super Alloy
F1284P	I	36.55 mm	5.47 mm	107.1 mm	2.25 mm	10° Super Flo. Stock size. Single Groove
F1285P	I	37.55 mm	5.47 mm	107.1 mm	2.25 mm	10° Super Flo. + 1 mm oversize. Single Groove
TOYOTA LANDCRUISER 4.5L - DOHC 24 VALVE (1FZFE) - 1993-1997						
F2170P	E	32 mm	6.97 mm	98.25 mm	2.54 mm	22° Flo. Stock size. Special Alloy
F2185P	E	32 mm	6.97 mm	98.25 mm	2.54 mm	22° Flo. Stock size. Super Alloy. Turbo Applications
F2189P	E	33 mm	6.97 mm	98.25 mm	2.54 mm	22° Flo. + 1 mm oversize. Special Alloy
F2186P	E	33 mm	6.97 mm	98.25 mm	2.54 mm	22° Flo. + 1 mm oversize. Super Alloy. Turbo Appl.
F2168P	E	35 mm	6.97 mm	98.25 mm	2.54 mm	22° Flo. + 3 mm oversize. Special Alloy
F2171P	I	38 mm	6.98 mm	98.85 mm	2.54 mm	19° Flo. Stock size. Special Alloy
F2188P	I	39 mm	6.98 mm	98.85 mm	2.54 mm	19° Flo. + 1 mm oversize. Special Alloy
F2169P	I	41 mm	6.98 mm	98.85 mm	2.54 mm	19° Flo. + 3 mm oversize. Special Alloy
TOYOTA 2.0 L - 3SGE ENGINE						
F1944P	E	30.1 mm	5.46 mm	109.32 mm	2.25 mm	20° Flo. Oversize. Special Alloy
F1945P	I	35.5 mm	5.47 mm	106.63 mm	2 mm	12° Super Flo. Oversize
TOYOTA SUPRA 3.0L - DOHC 24 VALVE (7MGE-TURBO 7MGTE) - 1986-1992						
F1861P	E	27.5 mm	6 mm	98.20 mm	4 mm	25° Flo. Stock size. Super Alloy
F1862P	E	28.5 mm	6 mm	98.20 mm	4 mm	25° Flo. 1 mm oversize. Super Alloy
F1859P	I	32 mm	6 mm	98.20 mm	4 mm	25° Super Flo. Stock size
F1860P	I	33 mm	6 mm	98.20 mm	4 mm	25° Super Flo. 1 mm oversize
TOYOTA SUPRA 3.0L I/L 6 CYL - DOHC 24 VALVE (2JZGE-2JZGTE) - 1994-1998						
F1499P	E	29 mm	5.98 mm	99.1 mm	3.5 mm	22° Flo. Stock size. Super Alloy
F1497P	E	30 mm	5.98 mm	99.1 mm	3.5 mm	22° Flo. 1 mm oversize. Super Alloy
F1498P	I	33.6 mm	5.98 mm	98.55 mm	3.5 mm	20° Super Flo. Stock size
F1496P	I	34.6 mm	5.98 mm	98.55 mm	3.5 mm	20° Super Flo. 1 mm oversize
TOYOTA SUPRA 3.0L - DOHC 24 VALVE (B58) TURBO - 2019						
F2430P	E	28.50 mm	5.96 mm	99.80 mm	4.98 mm	21° Taper Flo. Stock size. Triple radial groove. Super Alloy
F2433P	E	29.50 mm	5.96 mm	99.80 mm	4.98 mm	21° Taper Flo. Over size +1mm. Triple radial groove. Super Alloy
F2431P	I	30.10 mm	4.97 mm	99.15 mm	4.50 mm	19° Super Flo. Stock size. Triple radial groove.
F2434P	I	30.60 mm	4.97 mm	99.15 mm	4.50 mm	19° Super Flo. Over size +.5mm. Triple radial groove.
NOTE: The Exhaust valves feature a 1mm reduction stem in the tip area to allow the use of the OEM Factory rocker arm.						
TOYOTA TACOMA (2RZ - 3RZ) - 1995-2004						
F1993P	E	30.60 mm	5.967 mm	103.6 mm	3.50 mm	21° Flo. Dish Head. Stock size. Special Alloy
F1995P	E	31.60 mm	5.967 mm	103.6 mm	3.50 mm	21° Flo. Dish Head - 1mm oversize. Special Alloy
F1992P	I	37.55 mm	5.97 mm	103.6 mm	3.50 mm	19° Super Flo. Dish Head. Stock size.
F1994P	I	38.55 mm	5.97 mm	103.6 mm	3.50 mm	19° Super Flo. Dish Head. - 1mm oversize.
TOYOTA GT86 2.0L - DOHC 16 VALVE (4U-GSE) EUROPE - 2012-2014						
F2356P	E	29mm	5.45mm	95.3mm	7.5mm	29° Flo. Flat head. Stock size. Super Alloy
F2359P	E	30mm	5.45mm	95.3mm	7.5mm	29° Flo. Flat head. +1mm oversize. Super Alloy
F2357P	I	35mm	5.46mm	103.45mm	6.5mm	10° Super Flo. Flat Head. Stock size
F2358P	I	36mm	5.46mm	103.45mm	6.5mm	10° Super Flo. Flat Head. +1mm oversize
TOYOTA GT86 2.0L - DOHC 16 VALVE (4U-GSE) EUROPE - 2015						
F2378P	E	29mm	5.45mm	97.6mm	10.1mm	29° Flo. Flat Head. Stock. Super Alloy
F2380P	E	30mm	5.45mm	97.6mm	10.1mm	29° Flo. Flat Head. +1mm. Super Alloy
F2379P	I	35mm	5.46mm	105mm	8.2mm	10° Super Flo. Flat Head. Stock. Special Alloy
F2381P	I	36mm	5.46mm	105mm	8.2mm	10° Super Flo. Flat Head. +1mm. Special Alloy
VW 1.8T - DOHC 20 VALVE - 1998-2005						
F1554P	E	29.9 mm	5.96 mm	103.92 mm	5 mm	26° Flo. Stock size. Trip. Groove. 2 Valves Required
F1555P	E	30.9 mm	5.96 mm	103.92 mm	5 mm	26° Flo. + 1 mm o/s. Trip. Groove. 2 Valves Required
F1556P	I	26.9 mm	5.97 mm	105.1 mm	5 mm	24° Sup Flo. Stock size. Trip Groove. 3 Valves Required
F1557P	I	27.9 mm	5.97 mm	105.1 mm	5 mm	24° Sup Flo. + 1 mm o/s. Trip. Groove. 3 Valves Required

COMPETITION PLUS VALVES

Part#	Type	Head Diam.	Stem Diam.	Overall Length	Tip Length	References
VW 2.0T FSI - DOHC 16 VALVE - 2006-2008						
VW 2.0T TSI - DOHC 16 VALVE - 2009-2013						
VW GOLF R 2.0T TSI - DOHC 16 VALVE - 2015-2016						
F2177P	E	28 mm	5.97 mm	102 mm	5 mm	24° Flo. Stock size. Triple Groove. Super Alloy
F2178P	E	29 mm	5.97 mm	102 mm	5 mm	24° Flo. + 1 mm o/size. Triple Groove. Super Alloy
F2179P	I	33.9 mm	5.99 mm	104 mm	5 mm	20° Super Flo. Stock size. Triple Groove
F2180P	I	34.9 mm	5.99 mm	104 mm	5 mm	20° Super Flo. + 1 mm o/size. Triple Groove.
VW BEETLE/GOLF/JETTA/RABBIT 2.5L - DOHC 20 VALVE (BTW) - 2005- 1/2 2009						
F2177P	E	28 mm	5.97 mm	102 mm	5 mm	24° Flo. Stock size. Triple Groove. Super Alloy
F2178P	E	29 mm	5.97 mm	102 mm	5 mm	24° Flo. + 1 mm o/size. Triple Groove. Super Alloy
F2194P	I	32.35 mm	5.98 mm	104 mm	5 mm	20° Super Flo. Stock size. Triple Groove
F2195P	I	33.35 mm	5.98 mm	104 mm	5 mm	20° Super Flo. + 1 mm o/size. Triple Groove.
VW VR6 2.8L - DOHC 12 VALVE -1992-2002 (*)						
F1932P	E	34 mm	6.96 mm	106.90 mm	2.25 mm	19° Flo. Stock Size. Single Groove
F1920P	E	35 mm	6.96 mm	106.90 mm	2.25 mm	19° Flo. + 1 mm oversize. Single Groove
F1921P	E	35 mm	6.96 mm	106.90 mm	2.25 mm	19° S. Flo. + 1 mm o/size. S. Alloy. Turbo Appl. Single Groove
F2135P	E	36 mm	6.96 mm	106.90 mm	2.25 mm	19° S. Flo. + 2 mm o/size. S. Alloy. Turbo Appl. Single Groove
F1931P	I	39 mm	6.98 mm	106.15 mm	2.25 mm	12° S. Flo. Stock Size. Single Groove
F1919P	I	40 mm	6.98 mm	106.15 mm	2.25 mm	12° S. Flo. + 1 mm oversize. Single Groove
F2136P	I	41 mm	6.98 mm	106.15 mm	2.25 mm	12° S. Flo. + 2 mm oversize. Single Groove

(*) These Ferrea Valves are designed with Flat Face for increased compression.

VW VR6 2.8L - DOHC 24 VALVE (BDF) - 2002-2004 (*)

F1988P	E	27.00mm	5.94mm	136.48mm	4.6mm	25° Flo. Triple Gro. Special Alloy. - Stock size
F1989P	E	27.00mm	5.94mm	102.58mm	4.6mm	25° Flo. Triple Gro. Special Alloy. - Stock size
F1990P	E	28.00mm	5.94mm	136.48mm	4.6mm	25° Flo. Triple Gro. Special Alloy. - 1mm oversize
F1991P	E	28.00mm	5.94mm	102.58mm	4.6mm	25° Flo. Triple Gro. Special Alloy. - 1mm oversize
F2137P	E	29.00mm	5.94mm	136.48mm	4.6mm	25° Flo. Triple Gro. Special Alloy. - 2mm oversize
F2138P	E	29.00mm	5.94mm	102.58mm	4.6mm	25° Flo. Triple Gro. Special Alloy. - 2mm oversize
F1984P	I	31.00mm	5.95mm	136.70mm	4.6mm	25° S. Flo. Triple Gro. Special Alloy. - Stock size
F1985P	I	31.00mm	5.95mm	102.40mm	4.6mm	25° S. Flo. Triple Gro. Special Alloy. - Stock size
F1986P	I	32.00mm	5.95mm	136.70mm	4.6mm	25° S. Flo. Triple Gro. Special Alloy. - 1mm o/size
F1987P	I	32.00mm	5.95mm	102.40mm	4.6mm	25° S. Flo. Triple Gro. Special Alloy. - 1mm o/size
F2139P	I	33.00mm	5.95mm	136.70mm	4.6mm	25° S. Flo. Triple Gro. Special Alloy. - 2mm o/size
F2140P	I	33.00mm	5.95mm	102.40mm	4.6mm	25° S. Flo. Triple Gro. Special Alloy. - 2mm o/size

(*) Every motor takes 6 long INT valves, 6 short INT valves, 6 long EXH valves, 6 short EXH valves

VW VR6 R32 3.2L - DOHC 24 VALVE 2004-2011

F2288P	E	30.20 mm	5.96 mm	136.48 mm	4.6 mm	25° Taper Flo. Stock size. Super Alloy.
F2289P	E	30.20 mm	5.96 mm	102.58 mm	4.6 mm	25° Taper Flo. Stock size. Super Alloy.
F2290P	E	31.20 mm	5.96 mm	136.48 mm	4.6 mm	25° Taper Flo. +1 mm oversize. Super Alloy.
F2291P	E	31.20 mm	5.96 mm	102.58 mm	4.6 mm	25° Taper Flo. +1 mm oversize. Super Alloy.
F2292P	I	33.20 mm	5.98 mm	136.70 mm	4.6 mm	20° Super Flo. Stock size.
F2293P	I	33.20 mm	5.98 mm	102.80 mm	4.6 mm	20° Super Flo. Stock size.
F2294P	I	34.20 mm	5.98 mm	136.70 mm	4.6 mm	20° Super Flo. +1 mm oversize.
F2295P	I	34.20 mm	5.98 mm	102.80 mm	4.6 mm	20° Super Flo. +1 mm oversize.

COMPETITION PLUS VALVES - BLANKS

Part#	Type	Head Diam.	Stem Diam.	Overall Length	Tip Length	References
BLANKS 4-5 mm ("REQUIRE LASH CAPS OR HARD TIPS")						
F0066	E	23 mm	4 mm	125 mm	BLANK	21° Flo-No Groove-No Tip. Special Alloy
F0064	E/I	26.5 mm	4 mm	125 mm	BLANK	21° Flo-No Groove-No Tip. Special Alloy
F0232	I	30 mm	4 mm	135 mm	BLANK	21° Super Flo. Special Alloy
F0173	E	28.5 mm	4.46 mm	120 mm	BLANK	12° Flo-No Groove-No Tip. Special Alloy
F0171	E/I	31 mm	4.48 mm	120 mm	BLANK	12° Taper Flo Bimetallic. Special Alloy
F0172	I	31 mm	4.48 mm	120 mm	BLANK	15° Taper Flo Bimetallic. Special Alloy
F0062	I	34 mm	4.48 mm	125 mm	BLANK	19° Flo-No Groove-No Tip. Special Alloy
F0063	E	26 mm	4.5 mm	125 mm	BLANK	21° Flo-No Groove-No Tip. Special Alloy
F0183	E	29 mm	4.95 mm	130 mm	BLANK	12° Taper Flo. Special Alloy
F0337	E	27 mm	4.97 mm	135 mm	BLANK	19° Flo. Special Alloy. Bi-Metallic
F0067	I	30 mm	4.97 mm	135 mm	BLANK	19° Flo-No Groove-No Tip. Special Alloy
F0069	E	34 mm	4.97 mm	140 mm	BLANK	19° Flo. Super Alloy.
F0184	I	34 mm	4.97 mm	130 mm	BLANK	12° Flo. Special Alloy
F0362	I	36 mm	4.97 mm	135 mm	BLANK	12° Flo. Special Alloy
F0065	E/I	38 mm	4.97 mm	135 mm	BLANK	19° Flo-No Groove-No Tip. Special Alloy
F0338	I	32.1 mm	4.98 mm	135 mm	BLANK	19° Super Flo. Dish Head
F0514	I	35mm	4.98mm	145mm	BLANK	20° Flo. Dish Head. Hardenable Seat
BLANKS 5-6 mm ("REQUIRE LASH CAPS OR HARD TIPS")						
F2415P	E	32 mm	5.46mm	145mm	BLANK	25° Taper Flo. Super Alloy
F0242	E	34 mm	5.48 mm	145 mm	BLANK	15° Taper Flo. Flat Head. Special Alloy
F1943P	E	32 mm	5.48 mm	140 mm	BLANK	22° Flo. Super Alloy Turbo Applications
F1459P	E	32 mm	5.48 mm	135 mm	BLANK	22° Flo. Super Alloy
F1457P	I	37 mm	5.48 mm	145 mm	BLANK	20° Super Flo. Special Alloy
F0241	I	41 mm	5.48 mm	135 mm	BLANK	14° Super Flo. Flat Head. Special Alloy
F0047	I	34 mm	5.5 mm	135 mm	BLANK	19° Super Flo-No Groove-No Tip. Special Alloy

COMPETITION PLUS VALVES - BLANKS

Part#	Type	Head Diam.	Stem Diam.	Overall Length	Tip Length	References
BLANKS 5-6 mm ("REQUIRE LASH CAPS OR HARD TIPS")						
F0253	I	42 mm	5.5 mm	135 mm	BLANK	19° Super Flo. Special Alloy
F1492P	E	34 mm	5.95 mm	140 mm	BLANK	21° Tulip Flo. Bimetallic Super Alloy
F1942P	E	34 mm	5.95 mm	140 mm	BLANK	21° Flo. Super Alloy Turbo Applications
F0176	E	36 mm	5.95 mm	135 mm	BLANK	21° Flo. Special Alloy
F2416P	I	37 mm	5.47 mm	145 mm	BLANK	24° Super Flo. Special Alloy
F0175	E	36 mm	5.96 mm	135 mm	BLANK	21° Super Flo-No Groove-No Tip. Special Alloy
F1580P	I	36 mm	5.97 mm	145 mm	BLANK	12° Super Flo-No Groove-No Tip. Special Alloy
F1581P	I	38 mm	5.97 mm	145 mm	BLANK	15° Super Flo-No Groove-No Tip. Special Alloy
F0174	I	42 mm	5.97 mm	135 mm	BLANK	19° Super Flo-No Groove-No Tip. Special Alloy
F0293	I	46 mm	5.97 mm	145 mm	BLANK	19° Super Flo. Special Alloy.
F1582P	I	46 mm	5.97 mm	145 mm	BLANK	12° Super Flo-No Groove-No Tip.
F1996P	E	38 mm	5.975mm	150 mm	BLANK	21° Tulip Taper Flo. Dish Head. Super Alloy
BLANKS 6-7 mm ("REQUIRE LASH CAPS OR HARD TIPS")						
F0060	I	40 mm	6 mm	145 mm	BLANK	19° Super Flo-No Groove-No Tip. Special Alloy
F1595P	E	31 mm	6.02 mm	145 mm	BLANK	25° Flo Special Alloy. Ford
F1596P	I	36 mm	6.03 mm	145 mm	BLANK	19° Super Flo. Ford
F1455P	E	32.5 mm	6.55 mm	135 mm	BLANK	22° Flo Super Alloy
F1941P	E	32.5 mm	6.55 mm	140 mm	BLANK	22° Flo Super Alloy Turbo Applications
F1453P	E	36 mm	6.57 mm	145 mm	BLANK	20° Super Flo. Special Alloy
F1438P	I	38 mm	6.58 mm	135 mm	BLANK	20° Super Flo
F1585P	E	34 mm	6.95 mm	145 mm	BLANK	15° Flo. No Groove-No Tip. Special Alloy
F0004	E	32.95 mm	6.97 mm	135 mm	BLANK	22° Flo-No Groove-No Tip. Special Alloy
F0034	E	36 mm	6.97 mm	145 mm	BLANK	22° Flo-No Groove-No Tip. Special Alloy
F0038	E	39 mm	6.97 mm	145 mm	BLANK	22° Tulip Flo-No Groove-No Tip. Special Alloy
F1586P	I	39 mm	6.97 mm	145 mm	BLANK	12° Super Flo. No Groove-No Tip. Special Alloy
F0002	I	41.95 mm	6.97 mm	135 mm	BLANK	20° Flo-No Groove-No Tip. Special Alloy
F1419P	E	34.5 mm	6.98 mm	135 mm	BLANK	30° Flo. Special Alloy
F1418P	I	40 mm	6.98 mm	135 mm	BLANK	20° Super Flo. Special Alloy
F0077	E	1.750	.275	5.710	BLANK	24° Tulip Flo. Special Alloy.Harley Davidson
F0078	I	2.100	.275	5.710	BLANK	24° Tulip Flo.Harley Davidson
BLANKS 7-8 mm ("REQUIRE LASH CAPS OR HARD TIPS")						
F0345	E	33mm	7mm	145mm	BLANK	22.5° Tulip Flo. Super Alloy
F0346	E	39mm	7mm	145mm	BLANK	22.5° Tulip Flo. Dish Head. Super Alloy
F0303B	E	41 mm	7 mm	117 mm	2.5 mm	25° Flo. Over Size. Triple Groove
F0039	I	46 mm	7mm	145 mm	BLANK	12° Flo-No Groove-No Tip. Special Alloy
F0301B	I	46 mm	7 mm	114.8 mm	2.5 mm	25° Super Flo. Over Size. Triple Groove
F2162P	E	32mm	7.09mm	145mm	BLANK	R. 12mm Flo. Flat Head
F2163P	I	38mm	7.01mm	145mm	BLANK	19° Super Flo. Flat Head
F2376P	I	38mm	7.10mm	145mm	BLANK	19° Super Flo. Flat Head. Special Alloy
F1583P	E	1.650	.313	6.000	BLANK	15° Super Flo. Special Alloy. GM LS7/L92
F1584P	E	1.650	.313	6.000	BLANK	24° Super Flo. Special Alloy. GM LS7/L92
F0230	E	41 mm	7.96mm	135 mm	BLANK	20° Super Flo. ducati. Special Alloy
F1587P	I	2.000	.3135	6.000	BLANK	12° Super Flo. GM LS7/L92
F1588P	I	2.200	.3135	6.000	BLANK	12° Super Flo. GM LS7/L92
F0229	I	47 mm	7.98mm	135 mm	BLANK	20° Super Flo. ducati. Special Alloy
F1442P	I	44 mm	8mm	110 mm	8.5 mm	10° Super Flo. Special Alloy
BLANKS 9 mm ("REQUIRE LASH CAPS OR HARD TIPS")						
F2332P	E	47mm	8.96mm	178mm	BLANK	25° Taper Flo. Special Alloy. Porsche
F2363P	E	47mm	8.96mm	178mm	BLANK	25° Flo. Flat Head. Special Alloy. Porsche
F2333P	I	53mm	8.98mm	178mm	BLANK	12° Super Flo. Flat Head. Porsche.
F2364P	I	53mm	8.98mm	178mm	BLANK	18° Flo. Flat Head. Porsche
F2307P	I	56mm	8.98mm	178mm	BLANK	10° Super Flo. Flat Head. Porsche
F2362P	I	56mm	8.98mm	178mm	BLANK	10° Flo. Flat Head. Porsche
BLANKS (TITANIUM)						
F0404	E	30 mm	4.98 mm	135 mm	BLANK	20° Flo Hi Temp
F0403	I	35 mm	4.98 mm	135 mm	BLANK	17° Super Flo
F0424	E	34 mm	5.5 mm	145 mm	BLANK	30° IRL-Indy
F0042	E	32 mm	5.5 mm	145 mm	BLANK	26° Tulip Flo
F0423	I	41 mm	5.5 mm	145 mm	BLANK	12° IRL-Indy
F0043	I	38 mm	5.5 mm	135 mm	BLANK	26° Tulip Super Flo
F0235	E	34 mm	5.95 mm	135 mm	BLANK	21° Flo. Dish Head
F0234	I	40 mm	5.97 mm	135 mm	BLANK	19° Super Flo. Flat Head
F0436	I	40 mm	5.98 mm	145 mm	BLANK	12° Taper Flo. Flat Head
F0437	E/I	45 mm	5.98 mm	145 mm	BLANK	12° Flo. Flat Head
F0406	E/I	50 mm	5.98 mm	145 mm	BLANK	12° Flo
F0040	E	40 mm	7 mm	145 mm	BLANK	26° Tulip Super Flo-Pro Stock
F0400	E	40 mm	7 mm	145 mm	BLANK	30° Tulip Super Flo-Pro Stock
F0041	I	50 mm	7 mm	145 mm	BLANK	25° Tulip Super Flo-Pro Stock
F0420	I	50 mm	7 mm	145 mm	BLANK	19° Super Flo-Pro Stock
F0056	I	50 mm	7 mm	145 mm	BLANK	15° Super Flo-Pro Stock
F0422	E	32.5 mm	7.095 mm	145 mm	BLANK	30° IRL-Indy
F0421	I	39 mm	7.1 mm	145 mm	BLANK	19° IRL-Indy

6000 SERIES COMPETITION VALVES

Part#	Type	Head Diam.	Stem Diam.	Overall Length	Tip Length	References
ACURA INTEGRA GSR 1.7L - DOHC VTEC 16 VALVE (B17A1) - 1992-1993						
ACURA INTEGRA GSR 1.8L - DOHC VTEC 16 VALVE (B18C1-C3) - 1994-2000						
F6049	E	28 mm	5.45 mm	102.5 mm	2.5 mm	25° Flo Stock size. Special Alloy
F6047	E	28.5 mm	5.45 mm	102.5 mm	2.5 mm	25° Flo - .5 mm oversize. Special Alloy
F6045	E	29 mm	5.45 mm	102.5 mm	2.5 mm	25° Flo - 1 mm oversize. Special Alloy
F6048	I	33 mm	5.47 mm	102.35 mm	2.5 mm	25° Super Flo. Stock size
F6046	I	33.5 mm	5.47 mm	102.35 mm	2.5 mm	25° Super Flo - .5 mm oversize
F6044	I	34 mm	5.47 mm	102.35 mm	2.5 mm	25° Super Flo - 1 mm oversize
ACURA INTEGRA LS-GS 1.8L - DOHC 16 VALVE (B18A1-B1) - 1990-2000						
F6015	E	28 mm	6.54 mm	106.02 mm	4.1 mm	30° Flo Dish Head - Stock size. Special Alloy
F6016	I	31 mm	6.57 mm	105.5 mm	4.1 mm	20° Super Flo Dish Head - Stock size
ACURA RSX 2.0L - DOHC VTEC 16 VALVE (K20) - 2001-2006						
F6071	E	30 mm	5.45 mm	109.15 mm	2.5 mm	22° Flo. Radius Groove - Stk size. Special Alloy
F6072	E	31 mm	5.45 mm	109.15 mm	2.5 mm	22° Flo. Radius Groove. + 1 mm over size. Special Alloy
F6073	I	35 mm	5.47 mm	109.3 mm	2.5 mm	20° Super Flo. Radius Groove. Stk size.
F6074	I	36 mm	5.47 mm	109.3 mm	2.5 mm	20° Super Flo. Radius Groove. + 1 mm over size
ACURA TSX 2.4L - DOHC i-VTEC 16 VALVE (K24Z3) - 2009-2014						
ACURA ILX 2.4L - DOHC i-VTEC 16 VALVE (K24Z7) - 2013-2015						
F6352	E	31 mm	5.45 mm	109.3 mm	2.1 mm	25° Flo. Stock size. Special Alloy
F6354	E	32 mm	5.45 mm	109.3 mm	2.1 mm	25° Flo. 1 mm oversize. Special Alloy
F6351	I	36 mm	5.47 mm	109.15 mm	2.1 mm	15° Super Flo. Stock size.
F6353	I	37 mm	5.47 mm	109.15 mm	2.1 mm	15° Super Flo. +1 mm oversize.
AUDI 80 QUATRO 2.2 L - DOHC 20 VALVE (7A) - 1989-1992						
AUDI 200 QUATRO 2.2 L - DOHC 20 VALVE (3B) - 1991						
AUDI COUPE QUATRO 2.2 L - DOHC 20 VALVE (7A) -1990-1991						
F6027	E	28.1 mm	6.93 mm	98.3 mm	2.8 mm	22° Flo Radius Groove. Stk size. Special Alloy
F6028	E	28.6 mm	6.93 mm	98.3 mm	2.8 mm	22° Flo Radius Groove. + 0.5 mm over size. Special Alloy
F6029	I	32 mm	6.96 mm	95.5 mm	2.6 mm	15° S. Flo Radius Groove. Stock size.
F6030	I	32.5 mm	6.96 mm	95.5 mm	2.6 mm	15° S. Flo Radius Groove. + 0.5 mm over size.
AUDI RS2 2.2 L - DOHC 20 VALVE (ADU) - 1994-1995						
AUDI S4 2.2 L - DOHC 20 VALVE (AAN) - 1992-1994						
AUDI S6 2.2 L - DOHC 20 VALVE (AAN) - 1995						
F6027	E	28.1 mm	6.93 mm	98.3 mm	2.8 mm	22° Flo Radius Groove. Stk size. Special Alloy
F6028	E	28.6 mm	6.93 mm	98.3 mm	2.8 mm	22° Flo Radius Groove. + 0.5 mm over size. Special Alloy
F6029	I	32 mm	6.96 mm	95.5 mm	2.6 mm	15° S. Flo Radius Groove. Stock size.
F6030	I	32.5 mm	6.96 mm	95.5 mm	2.6 mm	15° S. Flo Radius Groove. + 0.5 mm over size
AUDI V8 3.6 L - DOHC 32 VALVE (PT) - 1990-1991						
AUDI V8 4.2 L - DOHC 32 VALVE (ABH) -1992-1994						
F6027	E	28.1 mm	6.93 mm	98.3 mm	2.8 mm	22° Flo Radius Groove. Stk size. Special Alloy
F6028	E	28.6 mm	6.93 mm	98.3 mm	2.8 mm	22° Flo Radius Groove. + 0.5 mm over size. Special Alloy
F6029	I	32 mm	6.96 mm	95.5 mm	2.6 mm	15° S. Flo Radius Groove. Stock size.
F6030	I	32.5 mm	6.96 mm	95.5 mm	2.6 mm	15° S. Flo Radius Groove. + 0.5 mm over size
CITROEN SAXO 1.6L - 16 VALVE (TU5J4) - 1996 & UP						
F6758	E	24.56 mm	5.96 mm	104.4 mm	4.9 mm	20° Flo. Stock size
F6760	E	25.56 mm	5.96 mm	104.4 mm	4.9 mm	20° Flo. + 1 mm over size.
F6759	I	28.8 mm	5.98 mm	104.4 mm	4.9 mm	20° Super Flo. Stock size
F6761	I	29.8 mm	5.98 mm	104.4 mm	4.9 mm	20° Super Flo. + 1 mm over size.
FIAT BRAVO / STILO / TEMPRA 1.6L-DOHC 16 VALVE (178B-182A-M645TA15T) - 1995 & UP						
F6762	E	29.71 mm	6.98 mm	102.71 mm	3.1 mm	30° Flo. Stock size
F6764	E	30.71 mm	6.98 mm	102.71 mm	3.1 mm	30° Flo. + 1 mm over size.
F6763	I	30.45 mm	6.98 mm	102.52 mm	3.15 mm	25° Super Flo. Stock size
F6765	I	31.45 mm	6.98 mm	102.52 mm	3.15 mm	25° Super Flo. + 1 mm over size.
FIAT PUNTO TURBO / UNO TURBO 1.4L - 8 VALVE (176A) - 1993-1999						
F6768	E	33 mm	7.97 mm	109.11 mm	4.11 mm	15° Flo. Triple Groove. Stock size
F6770	E	34 mm	7.97 mm	109.11 mm	4.11 mm	15° Flo. Triple Groove. + 1 mm over size.
F6769	I	36 mm	7.98 mm	108.52 mm	4.06 mm	18° Super Flo. Triple Groove. Stock size
F6771	I	37 mm	7.98 mm	108.52 mm	4.06 mm	18° Super Flo. Triple Groove. + 1 mm over size.
FORD COSWORTH SIERRA / ESCORT 2.0L - DOHC 16 VALVE (N5B) - 1984-1997						
F6746	E	31.15 mm	7.95 mm	105.85 mm	1.6 mm	23° Flo. Stock size
F6748	E	32.15 mm	7.95 mm	105.85 mm	1.6 mm	23° Flo. + 1 mm over size.
F6747	I	35.12 mm	6.95 mm	105.44 mm	1.6 mm	30° Super Flo. Stock size
F6749	I	36.12 mm	6.95 mm	105.44 mm	1.6 mm	30° Super Flo. + 1 mm over size.
FORD ECOBOOST 2.3L - DOHC 16 VALVE - 2015						
F6343	E	30mm	5.46mm	104.75mm	3.75mm	25° Taper Flo. Stock. Special Alloy
F6344	I	32.5mm	5.47mm	103.55mm	4 mm	22° Super Flo. Stock.
HONDA ACCORD LX 2.4L - DOHC i-VTEC 16 VALVE (K24Z2) - 2008-2012						
HONDA CIVIC Si 2.4L - DOHC i-VTEC 16 VALVE (K24Z7) - 2012-2015						
F6352	E	31 mm	5.45 mm	109.3 mm	2.1 mm	25° Flo. Stock size. Special Alloy
F6354	E	32 mm	5.45 mm	109.3 mm	2.1 mm	25° Flo. 1 mm oversize. Special Alloy
F6351	I	36 mm	5.47 mm	109.15 mm	2.1 mm	15° Super Flo. Stock size.
F6353	I	37 mm	5.47 mm	109.15 mm	2.1 mm	15° Super Flo. +1 mm oversize.

6000 SERIES COMPETITION VALVES

Part#	Type	Head Diam.	Stem Diam.	Overall Length	Tip Length	References
HONDA CIVIC 1.6L - SOHC 16 VALVE (D16Z6-Y5-Y7-Y8) - 1992-2000						
F6067	E	26 mm	5.46 mm	115.95 mm	1.9 mm	22° Flo. Radius Groove. Stk size
F6070	E	27 mm	5.46 mm	115.95 mm	1.9 mm	22° Flo. Radius Groove. + 1 mm over size.
F6068	I	30 mm	5.48 mm	118.6 mm	1.9 mm	20° Super Flo. Radius Groove. Stk size
F6069	I	31 mm	5.48 mm	118.6 mm	1.9 mm	20° Super Flo. Radius Groove. + 1 mm over size.
HONDA DEL SOL 1.6L - DOHC VTEC 16 VALVE (B16A1) - 1994-1997						
HONDA CIVIC SI 1.6L - DOHC VTEC 16 VALVE (B16A3) - 1999-2000						
F6049	E	28 mm	5.45 mm	102.5 mm	2.5 mm	25° Flo Stock size. Special Alloy
F6047	E	28.5 mm	5.45 mm	102.5 mm	2.5 mm	25° Flo - .5 mm oversize. Special Alloy
F6045	E	29 mm	5.45 mm	102.5 mm	2.5 mm	25° Flo - 1 mm oversize. Special Alloy
F6048	I	33 mm	5.47 mm	102.35 mm	2.5 mm	25° Super Flo. Stock size
F6046	I	33.5 mm	5.47 mm	102.35 mm	2.5 mm	25° Super Flo - .5 mm oversize
F6044	I	34 mm	5.47 mm	102.35 mm	2.5 mm	25° Super Flo - 1 mm oversize
HONDA CRV 2.0L - DOHC 16 VALVE (B20A-B20Z) - 1997-2000						
F6015	E	28 mm	6.54 mm	106.02 mm	4.1 mm	30° Flo Dish Head - Stock size. Special Alloy
F6016	I	31 mm	6.57 mm	105.5 mm	4.1 mm	20° Super Flo Dish Head - Stock size
HONDA CIVIC TYPE-R 2.0L - DOHC VTEC 16 VALVE (K20C1-TURBO) - 2017-2018						
F6355	E	29 mm	5.47 mm	114.75 mm	2.1 mm	28° Taper Flo. Stock size. Special Alloy
F6356	E	30 mm	5.47 mm	114.75 mm	2.1 mm	28° Taper Flo. +1 mm oversize. Special Alloy
F6357	I	35 mm	5.48 mm	117.25 mm	2.1 mm	20° Super Flo. Stock size.
F6358	I	36 mm	5.48 mm	117.25 mm	2.1 mm	20° Super Flo. +1 mm oversize.
HONDA PRELUDE 2.2L - DOHC VTEC 16 VALVE (H22A1-A4) - 1993-2000						
F6023	E	30 mm	5.48 mm	107.1 mm	2.8 mm	22° Flo. Stock size. Special Alloy
F6058	E	31 mm	5.48 mm	107.1 mm	2.8 mm	22° Flo. 1 mm oversize. Special Alloy
F6024	I	35 mm	5.48 mm	106.85 mm	2.8 mm	20° Super Flo. Stock size
F6056	I	36 mm	5.48 mm	106.85 mm	2.8 mm	20° Super Flo. 1 mm oversize
HONDA S 2000 - F20C - 2000-2003						
HONDA S 2000 - F22C - 2004-2008						
F6329	E	31 mm	5.46 mm	109 mm	2.5 mm	24° Flo. Stock size. Special Alloy
F6330	I	36 mm	5.48 mm	109.8 mm	2.5 mm	22° Super Flo. Stock size.
HYUNDAI GENESIS 2.0L - DOHC 16 VALVE (TURBO BK) - 2008-2010						
F6292	E	29.00 mm	5.46 mm	105.90 mm	2.32 mm	25° Flo. Stock size. Special Alloy
F6293	E	30.00 mm	5.46 mm	105.90 mm	2.32 mm	25° Flo. + 1 mm oversize. Special Alloy
F6294	I	35.00 mm	5.47 mm	113.25 mm	4.24 mm	15° S. Flo. Stock size.
F6295	I	36.00 mm	5.47 mm	113.25 mm	4.24 mm	15° S. Flo. + 1 mm oversize.
MITSUBISHI ECLIPSE GS-GST 2.0L - DOHC 16 VALVE (4G63-4G63T) - 1990-1999						
MITSUBISHI EVOLUTION VIII 2.0L - DOHC 16 VALVE (TURBO 4G63T) - 2003-2007						
F6025	E	30.5 mm	6.55 mm	109.7 mm	3.8 mm	22° Flo. Stock size. Special Alloy
F6054	E	31.5 mm	6.55 mm	109.7 mm	3.8 mm	22° Flo. 1 mm oversize. Special Alloy
F6026	I	34 mm	6.57 mm	109.7 mm	3.8 mm	20° Super Flo. Stock size
F6052	I	35 mm	6.57 mm	109.7 mm	3.8 mm	20° Super Flo. 1 mm oversize
MITSUBISHI EVOLUTION X 2.0L -DOHC 16 VALVE (4B11T) - 2007-2009						
F6292	E	29 mm	5.46 mm	105.90 mm	2.32 mm	25° Flo. Stock size. Single Groove. Special Alloy
F6293	E	30 mm	5.46 mm	105.90 mm	2.32 mm	25° Flo. + 1 mm oversize. Single Groove. Special Alloy
F6294	I	35 mm	5.47 mm	113.25 mm	4.24 mm	15° Super Flo. Stock size. Single Groove
F6295	I	36 mm	5.47 mm	113.25 mm	4.24 mm	15° Super Flo. + 1 mm oversize. Single Groove
NISSAN 350 Z 3.5 L - V-6 - DOHC 24 VALVE (VQ35) - 2003-2008						
F6017	E	31.35 mm	5.96 mm	94.4 mm	3.5 mm	22° Flo. Radius Groove. Stock size.
F6018	E	32.35 mm	5.96 mm	94.4 mm	3.5 mm	22° Flo. Radius Groove. + 1 mm over size
F6019	I	37.15 mm	5.97 mm	96.7 mm	3.5 mm	20° S. Flo. Radius Groove. Stock size.
F6020	I	38.15 mm	5.97 mm	96.7 mm	3.5 mm	20° S. Flo. Radius Groove. + 1 mm over size
(*) These valves feature a .5 mm stem reduction in the groove area to allow the use of OEM components (valve locks and spring retainers).						
PEUGEOT RALLY 106 1.6L - 16 VALVE (TU5J4) - 1996 & UP						
F6758	E	24.56 mm	5.96 mm	104.4 mm	4.9 mm	20° Flo. Stock size.
F6760	E	25.56 mm	5.96 mm	104.4 mm	4.9 mm	20° Flo. + 1 mm over size
F6759	I	28.8 mm	5.98 mm	104.4 mm	4.9 mm	20° Super Flo. Stock size.
F6761	I	29.8 mm	5.98 mm	104.4 mm	4.9 mm	20° Super Flo. + 1 mm over size
SCION tC 2.5L - DOHC 16 VALVE (2ARFE) - 2011						
F6325	E	31 mm	5.47 mm	113.0 mm	5.5 mm	24° Flo. Stock size. Special Alloy.
F6326	E	32 mm	5.47 mm	113.0 mm	5.5 mm	24° Flo. + 1 mm oversize. Special Alloy.
F6327	I	36.5 mm	5.48 mm	104.0 mm	5.5 mm	12° S. Flo. Stock size.
F6328	I	37.5 mm	5.48 mm	104.0 mm	5.5 mm	12° S. Flo. + 1 mm oversize.
SCION FR-S 2.0L - DOHC 16 VALVE (4U-GSE) - 2012-2014						
F6335	E	29mm	5.45mm	95.3mm	7.5mm	29° Flo. Flat head. Stock size. Special Alloy
F6336	E	30mm	5.45mm	95.3mm	7.5mm	29° Flo. Flat head. +1mm oversize. Special Alloy
F6337	I	35mm	5.46mm	103.45mm	6.5mm	10° Super Flo. Flat Head. Stock size
F6338	I	36mm	5.46mm	103.45mm	6.5mm	10° Super Flo. Flat Head. +1mm oversize
SCION FR-S 2.0L - DOHC 16 VALVE (4U-GSE) - 2015						
F6347	E	29mm	5.45mm	97.6mm	10.1mm	29° Flo. Flat Head. Stock.Special Alloy
F6348	E	30mm	5.45mm	97.6mm	10.1mm	29° Flo. Flat Head. +1mm. Special Alloy
F6349	I	35mm	5.46mm	105mm	8.2mm	10° Super Flo. Flat Head. Stock. Special Alloy
F6350	I	36mm	5.46mm	105mm	8.2mm	10° Super Flo. Flat Head. +1mm. Special Alloy

6000 SERIES COMPETITION VALVES

Part#	Type	Head Diam.	Stem Diam.	Overall Length	Tip Length	References
SUBARU WRX 2.0L - DOHC 16 VALVE (EJ20) - 2001-2008						
SUBARU WRX 2.0L - DOHC 16 VALVE (STI) - 2004-2008						
F6075	E	32 mm	5.96 mm	104.75 mm	3.5 mm	25° Flo. Radius Groove. Stock size. Special Alloy
F6076	E	33 mm	5.96 mm	104.75 mm	3.5 mm	25° Flo. Radius Groove. + 1 mm over size. Special Alloy
F6077	I	36 mm	5.97 mm	104.6 mm	3.5 mm	19° S. Flo. Radius Groove. Stock size.
F6078	I	37 mm	5.97 mm	104.6 mm	3.5 mm	19° S. Flo. Radius Groove. + 1 mm over size.
NOTE: These Ferrea Valves must be used with Ferrea Valve Locks # K10061.						
SUBARU BRZ 2.0L - DOHC 16 VALVE (FA20) - 2012-2014						
F6335	E	29mm	5.45mm	95.3mm	7.5mm	29° Flo. Flat head. Stock size. Special Alloy
F6336	E	30mm	5.45mm	95.3mm	7.5mm	29° Flo. Flat head. +1mm oversize. Special Alloy
F6337	I	35mm	5.46mm	103.45mm	6.5mm	10° Super Flo. Flat Head. Stock size
F6338	I	36mm	5.46mm	103.45mm	6.5mm	10° Super Flo. Flat Head. +1mm oversize
SUBARU BRZ 2.0L - DOHC 16 VALVE (FA20) - 2015						
F6347	E	29mm	5.45mm	97.6mm	10.1mm	29° Flo. Flat Head. Stock.Special Alloy
F6348	E	30mm	5.45mm	97.6mm	10.1mm	29° Flo. Flat Head. +1mm. Special Alloy
F6349	I	35mm	5.46mm	105mm	8.2mm	10° Super Flo. Flat Head. Stock. Special Alloy
F6350	I	36mm	5.46mm	105mm	8.2mm	10° Super Flo. Flat Head. +1mm. Special Alloy
SUZUKI SWIFT 1.3L - DOHC 16 VALVE (G13) - 2005-2012						
F6766	E	24.5 mm	5.45 mm	104.65 mm	4.2 mm	20° Flo. + 0.5 oversize.
F6767	I	29.5 mm	5.47 mm	105.35 mm	4.2 mm	15° Super Flo. + 0.5 oversize.
TOYOTA 4AGELU 1.6L - DOHC 20 VALVE - 1995-1998						
F6331	E	26mm	4.98mm	108.45mm	4.91mm	22° Taper Flo. Stock size. Special Alloy. 2 Valves required
F6332	I	26.5mm	4.98mm	98.42mm	5.06mm	12° Super Flo. Stock size. 3 Valves required
TOYOTA MR2 2.0L -DOHC 16 VALVE (TURBO 3SGTE) - 1990-1995						
F6065	E	29 mm	5.97 mm	99.65 mm	3.5 mm	25° Flo. Stock size. Special Alloy
F6066	E	30 mm	5.97 mm	99.65 mm	3.5 mm	25° Flo. 1 mm oversize. Special Alloy
F6063	I	33.5 mm	5.98 mm	100.70 mm	3.5 mm	25° Super Flo. Stock size
F6064	I	34.5 mm	5.98 mm	100.70 mm	3.5 mm	25° Super Flo. 1 mm oversize
TOYOTA MR2 2.0L - DOHC 16 VALVE (3SGTE GEN 3) - 1996-1998						
F6065	E	29 mm	5.97 mm	99.65 mm	3.5 mm	25° Flo. Stock size. Special Alloy
F6066	E	30 mm	5.97 mm	99.65 mm	3.5 mm	25° Flo. 1 mm oversize. Special Alloy
F6063	I	33.5 mm	5.98 mm	100.70 mm	3.5 mm	25° Super Flo. Stock size
F6064	I	34.5 mm	5.98 mm	100.70 mm	3.5 mm	25° Super Flo. 1 mm oversize
TOYOTA SUPRA 3.0L I/L 6 CYL - DOHC 24 VALVE (2JZGE-2JZGTE) - 1994-1998						
F6099	E	29 mm	5.98 mm	99.1 mm	3.5 mm	22° Flo. Stock size. Special Alloy
F6097	E	30 mm	5.98 mm	99.1 mm	3.5 mm	22° Flo. 1 mm oversize. Special Alloy
F6098	I	33.60 mm	5.98 mm	98.55 mm	3.5 mm	20° Super Flo. Stock size
F6096	I	34.60 mm	5.98 mm	98.55 mm	3.5 mm	20° Super Flo. 1 mm oversize
TOYOTA TACOMA - 1995-2004						
F6669	I	40 mm	5.97 mm	103.15 mm	3.80 mm	19° Super Flo. Oversize
TOYOTA GT86 2.0L - DOHC 16 VALVE (4U-GSE) EUROPE - 2012-2014						
F6335	E	29mm	5.45mm	95.3mm	7.5mm	29° Flo. Flat head. Stock size. Special Alloy
F6336	E	30mm	5.45mm	95.3mm	7.5mm	29° Flo. Flat head. +1mm oversize. Special Alloy
F6337	I	35mm	5.46mm	103.45mm	6.5mm	10° Super Flo. Flat Head. Stock size
F6338	I	36mm	5.46mm	103.45mm	6.5mm	10° Super Flo. Flat Head. +1mm oversize
TOYOTA GT86 2.0L - DOHC 16 VALVE (4U-GSE) 2015						
F6347	E	29mm	5.45mm	97.6mm	10.1mm	29° Flo. Flat Head. Stock.Special Alloy
F6348	E	30mm	5.45mm	97.6mm	10.1mm	29° Flo. Flat Head. +1mm. Special Alloy
F6349	I	35mm	5.46mm	105mm	8.2mm	10° Super Flo. Flat Head. Stock. Special Alloy
F6350	I	36mm	5.46mm	105mm	8.2mm	10° Super Flo. Flat Head. +1mm. Special Alloy
VW GOLF / JETTA 1.8 L - DOHC 16 VALVE (PL) -1987-1989						
VW SCIROCCO 1.8 L - DOHC 16 VALVE (PL) -1986-1988						
F6027	E	28.1 mm	6.93 mm	98.3 mm	2.8 mm	22° Flo Radius Groove. Stk size. Special Alloy
F6028	E	28.6 mm	6.93 mm	98.3 mm	2.8 mm	22° Flo Radius Groove. + 0.5 mm over size. Special Alloy
F6029	I	32 mm	6.96 mm	95.5 mm	2.6 mm	15° S. Flo Radius Groove. Stock size.
F6030	I	32.5 mm	6.96 mm	95.5 mm	2.6 mm	15° S. Flo Radius Groove. + 0.5 mm over size
VW GOLF / JETTA 2.0 L - DOHC 16 VALVE (9A) -1990-1992						
VW PASSAT 2.0 L - DOHC 16 VALVE (9A) -1990-1994						
F6027	E	28.1 mm	6.93 mm	98.3 mm	2.8 mm	22° Flo Radius Groove. Stk size. Special Alloy
F6028	E	28.6 mm	6.93 mm	98.3 mm	2.8 mm	22° Flo Radius Groove. + 0.5 mm over size. Special Alloy
F6029	I	32 mm	6.96 mm	95.5 mm	2.6 mm	15° S. Flo Radius Groove. Stock size.
F6030	I	32.5 mm	6.96 mm	95.5 mm	2.6 mm	15° S. Flo Radius Groove. + 0.5 mm over size

5000 SERIES HI PERFORMANCE VALVES

Part#	Type	Head Diam.	Stem Diam.	Overall Length	Tip Length	References
ACURA INTEGRA GSR 1.7L - DOHC VTEC 16 VALVE (B17A1) - 1992-1993						
ACURA INTEGRA GSR 1.8L - DOHC VTEC 16 VALVE (B18C1-C3) - 1994-2000						
F5500	E	28 mm	5.45 mm	102.5 mm	2.5 mm	25° Flo. Stock size. Flat Head. Special Alloy
F5501	E	29 mm	5.45 mm	102.5 mm	2.5 mm	25° Flo. + 1 mm oversize. Flat Head. Special Alloy
F5502	I	33 mm	5.47 mm	102.35 mm	2.5 mm	25° Super Flo. Stock size. Flat Head
F5503	I	34 mm	5.47 mm	102.35 mm	2.5 mm	25° Super Flo. + 1 mm oversize. Flat Head
ACURA RSX 2.0L - DOHC VTEC 16 VALVE (K20) - 2001-2008						
F5508	E	30 mm	5.45 mm	109.15 mm	2.5 mm	22° Flo. Stock size. Flat Head. Special Alloy
F5509	E	31 mm	5.45 mm	109.15 mm	2.5 mm	22° Flo. + 1 mm oversize. Flat Head. Special Alloy
F5510	I	35 mm	5.47 mm	109.3 mm	2.5 mm	20° Super Flo. Stock size. Flat Head
F5511	I	36 mm	5.47 mm	109.3 mm	2.5 mm	20° Super Flo. + 1 mm oversize. Flat Head
HONDA CIVIC 1.6L - SOHC 16 VALVE (D16Z6-Y5-Y7-Y8) - 1992-2000						
F5512	E	26 mm	5.46 mm	115.95 mm	1.9 mm	22° Flo. Stock size. Flat Head. Special Alloy
F5514	E	27 mm	5.46 mm	115.95 mm	1.9 mm	22° Flo. + 1 mm over size. Flat Head. Special Alloy
F5515	I	30 mm	5.48 mm	118.6 mm	1.9 mm	20° Super Flo. Stock size. Flat Head
F5516	I	31 mm	5.48 mm	118.6 mm	1.9 mm	20° Super Flo. + 1 mm over size. Flat Head
HONDA DEL SOL 1.6L - DOHC VTEC 16 VALVE (B16A1) - 1994-1997						
HONDA CIVIC SI 1.6L - DOHC VTEC 16 VALVE (B16A3) - 1999-2000						
F5500	E	28 mm	5.45 mm	102.5 mm	2.5 mm	25° Flo. Stock size. Flat Head. Special Alloy
F5501	E	29 mm	5.45 mm	102.5 mm	2.5 mm	25° Flo. + 1 mm oversize. Flat Head. Special Alloy
F5502	I	33 mm	5.47 mm	102.35 mm	2.5 mm	25° Super Flo. Stock size. Flat Head
F5503	I	34 mm	5.47 mm	102.35 mm	2.5 mm	25° Super Flo. + 1 mm oversize. Flat Head
HONDA PRELUDE 2.2L - DOHC VTEC 16 VALVE (H22A1-A4) - 1993-2000						
F5504	E	30 mm	5.48 mm	107.1 mm	2.5 mm	22° Flo. Stock size. Flat Head. Special Alloy
F5505	E	31 mm	5.48 mm	107.1 mm	2.5 mm	22° Flo. + 1 mm oversize. Flat Head. Special Alloy
F5506	I	35 mm	5.48 mm	106.85 mm	2.5 mm	20° Super Flo. Stock size. Flat Head
F5507	I	36 mm	5.48 mm	106.85 mm	2.5 mm	20° Super Flo. + 1 mm oversize. Flat Head

ROLLER ROCKER SYSTEM (1)

(1) U.S. Patent No. US6, 352, 062 B1.

Part#	References
ACURA INTEGRA GSR 1.7L - DOHC VTEC 16 VALVE (B17A1) - 1992-1993	
ACURA INTEGRA GSR 1.8L - DOHC VTEC 16 VALVE (B18C1-C3) - 1994-2000	
HONDA DEL SOL 1.6L - DOHC VTEC 16 VALVE (B16A1) - 1994-1997	
HONDA CIVIC SI 1.6L - DOHC VTEC 16 VALVE (B16A3) - 1999-2000	
RR1000	Aluminum-Magnesium CNC machined Stock rocker assembly mass: 252 grams. Ferrea rocker assembly mass: 135 grams (46% less mass than factory rockers) Stock fulcrum mass: 110 grams. Ferrea fulcrum mass: 65 grams. Must use stand alone ECU tuning system. To work properly you must disconnect the VTEC function and remove the "lost-motion assembly" components.
ACURA RSX 2.0L - DOHC VTEC 16 VALVE (K20) - 2001-2006	
RR1002	Recommended Maximun Net Lift: 15.25 mm. Aluminum-Magnesium CNC machined Stock rocker assembly mass: 307 grams. Ferrea rocker assembly mass: 154 grams (50% less mass than factory rockers) Stock fulcrum mass: 134 grams. Ferrea fulcrum mass: 76 grams. Can be used with stock or any aftermarket camshafts. Uses center lobe only, must use stand alone ECU tuning system. To work properly. you must disconnect the VTEC function and remove the "lost-motion assembly" components.
RR1004	Drag Racing Applications. Aluminum-Magnesium CNC machined. Stock rocker assembly mass: 307 grams. Ferrea rocker assembly mass: 160 grams (48% less mass than factory rockers) Stock fulcrum mass: 134 grams. Ferrea fulcrum mass: 78 grams. Can be used with stock or any aftermarket camshafts. Uses center lobe only, must use stand alone ECU tuning system. To work properly. you must disconnect the VTEC function. and remove the "lost-motion assembly" components.
HONDA CIVIC TYPE-R 2.0L - DOHC VTEC 16 VALVE (K20C1-TURBO) - 2017-2018	
RR1006	Aluminum-Magnesium CNC machined. Stock exhaust rocker assembly mass: 270 grams. Stock intake rocker assembly mass: 170 grams. Ferrea rocker assembly mass: 162 grams (40 % less mass than factory exhaust rockers). Stock exhaust rocker fulcrum mass: 122 grams. Stock intake rocker fulcumb mass: 87 grams. Ferrea fulcrum mass: 80 grams. Can be used with stock or any aftermarket camshafts. Uses center lobe only. To work properly, you must disconnect the VTEC function and remove the "lost-motion assembly" components. Note: Ferrea Valve Spring Kit S10166 must use Ferrea Rockers RR1006 due to rocker arm and retainer clearances. Ferrea Intake and exhaust rocker arms are different. INTAKE rocker arms are marked with RR1006-I and EXHAUST rocker arms are marked with RR1006-E.
LOTUS ELISE / EXIGE 1.8L - DOHC 16 VALVE (2ZZ-GE) - 2008	
TOYOTA 1.8L - DOHC 16 VALVE (2ZZ-GE) - 2003-2006	
RR1005	Maximum Net Lift: 13.5 mm. (With Ferrea Valve Spring Assembly) Aluminum-Magnesium CNC machined Stock rocker assembly mass: 268 grams. Ferrea rocker assembly mass: 138 grams (51 % less mass than factory rockers) Stock fulcrum mass: 97 grams. Ferrea fulcrum mass: 74 grams. Can be used with stock or any aftermarket camshafts. Uses center large lobe only, must use reprogrammed ECU or stand alone ECU tuning system. To work properly and provide lubrication to the rocker arms during operation, the ECU must control the VVTi timing sequence function.

BEEHIVE VALVE SPRINGS

Part#	Type/Material/ Application	O.D.	I.D.	Seat Press.	Open Press.	Rate Inch	Coil Bind	Max Net Lift
-------	-------------------------------	------	------	----------------	----------------	--------------	--------------	-----------------

ACURA INTEGRA GSR 1.7L DOHC VTEC 16 VALVE (B17A1) - 1992-1993

ACURA INTEGRA GSR 1.8L DOHC VTEC 16 VALVE (B18C1-C3) - 1994-2000

S2014	Single Beehive Ovate. PAC Alloy Nitrided	22.94mm	14.73mm	70 lbs	160 lbs	230 lbs	17.50mm	12.70mm
	Street Performance	30.48mm	22.27mm	@31.75mm	@21.75mm			
	This Spring requires Ferrea Titanium Retainer # E12020 and Ferrea Spring Seat Locator #SL1090 (Discard OEM Factory supplied Spring Seat Locator)							

ACURA RSX 2.0L - DOHC VTEC 16 VALVE (K20) - 2001-2006

S2018	Single Beehive Ovate. PAC Alloy Nitrided	23.87mm	14.73mm	90 lbs	225 lbs	342 lbs	24mm	14mm
	Street Performance	28.07mm	18.85mm	@39mm	@29mm			
	This Spring requires Ferrea Titanium Retainer # E12027 and Ferrea Spring Seat Locator #SL1094 (Discard OEM Factory supplied Spring Seat Locator)							

HONDA DEL SOL 1.6L - DOHC VTEC 16 VALVE (B16A1)-1994-1997

HONDA CIVIC SI 1.6L - DOHC VTEC 16 VALVE (B16A3)-1999-2000

S2014	Single Beehive Ovate. PAC Alloy Nitrided	22.94mm	14.73mm	70 lbs	160 lbs	230 lbs	17.50mm	12.70mm
	Street Performance	30.48mm	22.27mm	@31.75mm	@21.75mm			
	This Spring requires Ferrea Titanium Retainer # E12020 and Ferrea Spring Seat Locator #SL1090 (Discard OEM Factory supplied Spring Seat Locator)							

HONDA PRELUDE 2.2L - DOHC VTEC 16 VALVE (H22A1-A4) - 1993-2000

S2014	Single Beehive. Ovate. PAC Alloy Nitrided	22.94mm	14.73mm	70 lbs	160 lbs	230 lbs	17.50mm	12.70mm
	Street Performance	30.48mm	22.27mm	@31.75mm	@21.75mm			
	This Spring requires Ferrea Titanium Retainer # E12020 and Ferrea Spring Seat Locator #SL1090 (Discard OEM Factory supplied Spring Seat Locator)							

HONDA S 2000 - F20C - 2000-2003

HONDA S 2000 - F22C - 2004-2008

S2022	Single Beehive Ovate. PAC Alloy Nitrided	23.87mm	14.73mm					
	Street Performance	28.07mm	18.85mm					
	STOCK CAMSHAFT INTAKE ASSEMBLY			100 lbs	225 lbs	317 lbs	26.15mm	13mm
				@40.4mm	@30.4mm			
	EXHAUST ASSEMBLY			112 lbs	235 lbs	312 lbs	26.93mm	12.1mm
				@40.4mm	@30.4mm			
	This Spring requires Ferrea Titanium Retainer # E12030 and Ferrea Spring Seat Locator # SL1120 (EXH) and # SL 1119 (INT) (Discard OEM Factory supplied Spring Seat Locator)							
	STAGE 2 CAMSHAFT INTAKE ASSEMBLY			100 lbs	225 lbs	317 lbs	26.15mm	13mm
				@40.4mm	@30.4mm			
	EXHAUST ASSEMBLY			100 lbs	225 lbs	317 lbs	26.15mm	13mm
				@40.4mm	@30.4mm			
	This Spring requires Ferrea Titanium Retainer # E12030 and Ferrea Spring Seat Locator # SL1121 (EXH) and # SL 1119 (INT) (Discard OEM Factory supplied Spring Seat Locator)							

MITSUBISHI ECLIPSE GS-GST 2.0L - DOHC 16 VALVE (4G63-4G63T) - 1990-1999

S2015	Single Beehive Ovate. PAC Alloy	23.87mm	14.73mm	90 lbs	225 lbs	342 lbs	23mm	13.5mm
	Street Performance	28.07mm	18.85mm	@38mm	@28mm			
	This Spring requires Ferrea Titanium Retainer # E12021 and Ferrea Spring Seat Locator #SL1091 (Discard OEM Factory supplied Spring Seat Locator)							

TOYOTA SUPRA 3.0I I/L 6 CYL - DOHC 24 VALVE (2JZGE-2JZGTE) - 1994-1998

S2021	Single Beehive Ovate. PAC Alloy	23.87mm	14.73mm	110 lbs	240 lbs	330 lbs	21.85mm	11mm
	Street Performance	28.07mm	18.85mm	@35mm	@25mm			
	This Spring requires Ferrea Titanium Retainer # E12029 and Factory Spring Shims.							

VALVE SPRINGS

Part#	Type/Material/ Application	O.D.	I.D.	Seat Press.	Open Press.	Rate Inch	Coil Bind	Max Net Lift
ACURA INTEGRA GSR 1.7L - DOHC VTEC 16 VALVE (B17A1) - 1992-1993								
ACURA INTEGRA GSR 1.8L - DOHC VTEC 16 VALVE (B18C1-C3) - 1994-2000								
S10027	Dual Spring - Hi Pressure Special Alloy	22.8 mm 30.10 mm	17.15 mm 22.88 mm	100 lbs @ 34 mm	220 lbs @ 24 mm	305 lbs	20 mm	13.5 mm
This Spring requires Ferrea Titanium Retainer # E11000 or Ferrea Tool Steel Retainer #E20041 and Ferrea Spring Seat Locator # SL1000 (Discard OEM Spring Seat Locator)								
S10064	Dual Spring - Turbo Special Alloy- Hi Pressure	22.88 mm 30.10 mm	17.15 mm 22.88 mm	95 lbs @34 mm	215 lbs @24 mm	305 lbs	19 mm	14 mm
This Spring requires Ferrea Titanium Retainer # E11000 or Ferrea Tool Steel Retainer #E20041 and Ferrea Spring Seat Locator # SL1000 (Discard OEM Spring Seat Locator)								
S10070	Dual Spring - Special Alloy Endurance Spring	22.85 mm 30.45 mm	17.5 mm 22.85 mm	80 lbs @33 mm	190 lbs @23 mm	279 lbs	18 mm	14 mm
This Spring requires Ferrea Titanium Retainer # E11000 or E11000LW or Ferrea Tool Steel Retainer # E20041 and Ferrea Spring Seat Locator # SL1004 (Discard OEM Spring Seat Locator). Maximum Retainer Step: 3.6 mm								
S10086	Dual Spring Special Alloy Endurance Application	22.85mm 30.45mm	17.5mm 22.85mm	110 lb @ 34mm	260 lb @ 21mm	292 lbs	20 mm	13 mm
This Spring requires Ferrea Titanium Retainer # E11000 or E11000LW or Ferrea Tool Steel Retainer # E20041 and Ferrea Spring Seat Locator # SL1044 (Discard OEM Spring Seat Locator) This Spring requires Ferrea Roller Rocker # RR1000								
S10104	Dual Spring - Turbo - PAC enhanced Alloy	23.10 mm 30mm	17.2mm 23.10mm	80 lbs @34 mm	195 lbs @24 mm	292 lbs	20 mm	13.5 mm
This Spring requires Ferrea Titanium Retainer # E11000 or E11000LW or Ferrea Tool Steel Retainer # E20037 and Ferrea Spring Seat Locator # SL1000 (Discard OEM Spring Seat Locator)								
ACURA RSX 2.0L - DOHC VTEC 16 VALVE (K20) - 2001-2006								
S10099	Dual Spring-Special Alloy Endurance Spring	22.85 mm 30.45 mm	17.5 mm 22.85 mm	80 lbs @40 mm	190 lbs @30 mm	279 lbs	24 mm	14 mm
This Spring requires Ferrea Titanium Retainer # E11066 and Ferrea Spring Seat Locator # SL1052 (Discard OEM Spring Seat Locator).								
S10100	Dual Spring-Chrome Silicon Drag Racing	23.1 mm 31 mm	17.35 mm 23.1 mm	105 lbs @ 39 mm	225 lbs @ 29 mm	305 lbs	22 mm	15 mm
This Spring requires Ferrea Titanium Retainer # E11066 and Ferrea Spring Seat Locator # SL1053 (Discard OEM Spring Seat Locator)								
S10149	Dual Spring - PAC Enhanced High Lift Drag Racing	22.86 mm 30.38 mm	16.86 mm 22.86 mm	140 lbs @40 mm	265 lbs @30 mm	317 lbs	20 mm	18.4 mm
This Spring requires either Ferrea Titanium Retainer #E11125 or Ferrea Tool Steel Retainer # E20054, and Ferrea Spring Seat Locator #SL1136. (Discard OEM Factory Spring Seat Locator).								
ACURA TSX 2.4L - DOHC i-VTEC 16 VALVE (K24Z3) - 2009-2014								
ACURA ILX 2.4L - DOHC i-VTEC 16 VALVE (K24Z7) - 2013-2015								
S10164	Dual Spring-PAC Enhanced Drag / Enduro Racing	23.1 mm 31 mm	17.35 mm 23.1 mm	105 lbs @39 mm	225 lbs @29 mm	305 lbs	22 mm	15 mm
This Spring requires Ferrea Titanium Retainer # E11141 and Ferrea Spring Seat Locator # SL1149 (Discard OEM Spring Seat Locator)								
ACURA INTEGRA LS-GS 1.8L - DOHC 16 VALVE (B18A1-B1) - 1990-2000								
HONDA CRV 2.0L - DOHC 16 VALVE (B20A-B20Z) - 1997-2000								
S10046	Dual Chrome Silicon	20.8 mm 28.0 mm	16.51 mm 20.8 mm	60 lbs @ 36.5 mm	160 lbs @ 26.5 mm	254 lbs	20 mm	14 mm
This Spring requires Ferrea Titanium Retainer # E11023. Use (FOR EXHAUST APPLICATION ONLY) Ferrea Spring Seat Locator #SL1017 FOR INTAKE APPLICATION use Factory supplied Seat Locator.								
AUDI 1.8T - DOHC 20 VALVE - 1996-2005								
S10055	Single Spring - Turbo Special Alloy (Intake - 12 pieces)	21.5 mm	15.1 mm	65 lbs @ 34.5 mm	145 lbs @ 24.5 mm	216 lbs	22.5 mm	11 mm
This Spring requires Ferrea Titanium Retainer #E11031and Ferrea Spring Seat Locator #SL1025 (Discard OEM Spring Seat Locator).								
S10056	Dual Spring - Turbo Special Alloy (Exhaust - 8 pieces)	22.75 mm 29.5 mm	17.1 mm 22.75 mm	80 lbs @ 32.5 mm	180 lbs @ 22.5 mm	254 lbs	20 mm	12 mm
This Spring requires Ferrea Titanium Retainer #E11032 and Ferrea Spring Seat Locator #SL1026 (Discard OEM Spring Seat Locator).								

VALVE SPRINGS

Part#	Type/Material/ Application	O.D.	I.D.	Seat Press.	Open Press.	Rate Inch	Coil Bind	Max Net Lift
-------	-------------------------------	------	------	----------------	----------------	--------------	--------------	-----------------

AUDI 2.0T - FSI - DOHC 16 VALVE - 2006-2008

S10157	Single Spring - Turbo PAC Enhanced Alloy	22.38 mm	15.52 mm	80 lbs @37 mm	180 lbs @27mm	254 lbs	24.6 mm	11 mm
--------	---	----------	----------	------------------	------------------	---------	---------	-------

This Spring requires either Ferrea Titanium Retainer #E11129, and Ferrea Spring Seat Locator #SL1142. (Discard OEM factory supplied Spring Seat Locator). NOTE: Max Net Lift is limited due to the OEM factory valve seal install height.

AUDI 2.0T TFSI - DOHC 16 VALVE - 2009-2013

S10157	Single Spring - Turbo PAC Enhanced Alloy INTAKE ASSEMBLY	22.38 mm	15.52 mm	80 lbs @ 37 mm	180 lbs @ 27 mm	254 lbs	24.6 mm	11 mm
	EXHAUST ASSEMBLY			85 lbs @ 36.5 mm	185 lbs @ 26.5 mm	254 lbs	24.6 mm	10.5 mm

This Spring requires Ferrea Titanium Retainer (INTAKE) # E11139 and (EXHAUST) # E11140 and Ferrea Spring Seat Locator #SL1142. (Discard OEM Spring Seat Locator)

AUDI TTRS / RS3 2.5L TFSI - DOHC 20 VALVE (DAZA) TURBO - 2017-2018

S10170	Single Spring - Turbo PAC Enhanced Alloy INTAKE ASSEMBLY	22.38 mm	15.52 mm	80 lbs @ 37 mm	180 lbs @ 27 mm	254 lbs	24.6 mm	11 mm
	EXHAUST ASSEMBLY			85 lbs @ 36.5 mm	185 lbs @ 26.5 mm	254 lbs	24.6 mm	10.5 mm

This Spring requires Ferrea Titanium Retainer #E12035 and Ferrea Spring Seat Locator (INTAKE) # SL1162 and (EXHAUST) # SL1163. AND OEM Factory EXHAUST supplied Spring Seat Locator / Valve Hat Seal.

AUDI 2.7T - DOHC 30 VALVE (APB) - 1998-2004

S10055	Single Spring - Turbo Special Alloy (Intake - 18 pieces)	21.5 mm	15.1 mm	65 lbs @ 34.5 mm	145 lbs @ 24.5 mm	216 lbs	22.5 mm	11 mm
--------	--	---------	---------	---------------------	----------------------	---------	---------	-------

This Spring requires Ferrea Titanium Retainer #E11031 and Ferrea Spring Seat Locator #SL1025 (Discard OEM Spring Seat Locator).

S10056	Dual Spring - Turbo Special Alloy (Exhaust - 12 pieces)	22.75 mm 29.5 mm	17.1 mm 22.75 mm	80 lbs @ 32.5 mm	180 lbs @ 22.5 mm	254 lbs	20 mm	12 mm
--------	---	---------------------	---------------------	---------------------	----------------------	---------	-------	-------

This Spring requires Ferrea Titanium Retainer #E11032 and Ferrea Spring Seat Locator #SL1026 (Discard OEM Spring Seat Locator).

AUDI RS6 4.2L - DOHC V8 40 VALVE (BCY) - 2002-2004

S10055	Single Spring - Turbo Special Alloy (Intake - 24 pieces)	21.5 mm	15.1 mm	65 lbs @ 34.5 mm	145 lbs @ 24.5 mm	216 lbs	22.5 mm	11 mm
--------	--	---------	---------	---------------------	----------------------	---------	---------	-------

This Spring requires Ferrea Titanium Retainer #E11031 and Ferrea Spring Seat Locator #SL1025 (Discard OEM Spring Seat Locator).

AUDI RS6 4.2L - DOHC V8 40 VALVE (BCY) - 2002-2004

S10056	Dual Spring - Turbo Special Alloy (Exhaust - 16 pieces)	22.75 mm 29.5 mm	17.1 mm 22.75 mm	80 lbs @ 32.5 mm	180 lbs @ 22.5 mm	254 lbs	20.5 mm	12 mm
--------	---	---------------------	---------------------	---------------------	----------------------	---------	---------	-------

This Spring requires Ferrea Titanium Retainer #E11032 and Ferrea Spring Seat Locator #SL1026 (Discard OEM Spring Seat Locator).

AUDI 80 QUATRO 2.2 L - DOHC 20 VALVE (7A) - 1989-1992

AUDI 200 QUATRO 2.2 L - DOHC 20 VALVE (3B) - 1991

AUDI COUPE QUATRO 2.2 L - DOHC 20 VALVE (7A) - 1990-1991

S10115	Dual Spring Special Alloy Endurance Application	22.75 mm 29.5 mm	17.1 mm 22.75 mm	85 lbs @ 33 mm	205 lbs @ 23 mm	304 lbs	17.5 mm	14 mm
--------	---	---------------------	---------------------	-------------------	--------------------	---------	---------	-------

This Spring requires Ferrea Titanium Retainer # E11084 and Ferrea Seat Locator # SL1073 (Discard OEM Spring Seat Locator).

AUDI RS2 2.2 L - DOHC 20 VALVE (ADU) - 1994-1995

AUDI S4 2.2 L - DOHC 20 VALVE (AAN) - 1992-1994

AUDI S6 2.2 L - DOHC 20 VALVE (AAN) - 1995

S10115	Dual Spring Special Alloy Endurance Application	22.75 mm 29.5 mm	17.1 mm 22.75 mm	85 lbs @ 33 mm	205 lbs @ 23 mm	304 lbs	17.5 mm	14 mm
--------	---	---------------------	---------------------	-------------------	--------------------	---------	---------	-------

This Spring requires Ferrea Titanium Retainer # E11084 and Ferrea Seat Locator # SL1073 (Discard OEM Spring Seat Locator).

AUDI V8 3.6 L - DOHC 32 VALVE (PT) - 1990-1991

AUDI V8 4.2 L - DOHC 32 VALVE (ABH) - 1992-1994

S10115	Dual Spring Special Alloy Endurance Application	22.75 mm 29.5 mm	17.1 mm 22.75 mm	85 lbs @ 33 mm	205 lbs @ 23 mm	304 lbs	17.5 mm	14 mm
--------	---	---------------------	---------------------	-------------------	--------------------	---------	---------	-------

This Spring requires Ferrea Titanium Retainer # E11084 and Ferrea Seat Locator # SL1073 (Discard OEM Spring Seat Locator).

BMW E36 3.2L - DOHC 24 VALVE (S42 / M42 / M50/ S50 / M52 / M54) - 1990-2000

S10049	Dual Spring - Turbo Special Alloy	22.75 mm 29.5 mm	17.1 mm 22.75 mm	80 lbs @ 36 mm	180 lbs @ 26 mm	254 lbs	21 mm	14 mm
--------	--------------------------------------	---------------------	---------------------	-------------------	--------------------	---------	-------	-------

This Spring requires Ferrea Titanium Retainer #E11025 and Ferrea Spring Seat Locator #SL1021 (Discard OEM Spring Seat Locator).

BMW E46 3.2L - DOHC 24 VALVE (S54) - 2001-2006

S10156	Dual Spring - Endurance Special Alloy	20.8 mm 28.0 mm	16.51 mm 20.8 mm	85 lbs @41 mm	185 lbs @31 mm	254 lbs	26.5 mm	14.0 mm
--------	--	--------------------	---------------------	------------------	-------------------	---------	---------	---------

This Spring requires Ferrea Titanium Retainer #E11128, and Ferrea Spring Seat Locator #SL1141. (Discard OEM Factory supplied Spring Seat Locator)

VALVE SPRINGS

Part#	Type/Material/ Application	O.D.	I.D.	Seat Press.	Open Press.	Rate Inch	Coil Bind	Max Net Lift
BMW E60/E82/E91/E92 3.0L - DOHC 24 VALVE (N54) - 2007-2010								
S10158	Single Spring - Turbo PAC Enhanced Alloy	22.38 mm	15.52 mm	70 lbs @36.5mm	170 lbs @26.5mm	254 lbs	23.15 mm	12.5 mm
This Spring requires 2 Ferrea Titanium Retainer (EXHAUST) # E11130, and (INTAKE) # E11131 and Factory supplied Spring Seat Locator / Valve Hat Seal.								
DODGE NEON 2.4 - SRT4 - DOHC 16 VALVE (A853) - 2003-2005								
S10107	Dual Spring - Turbo Stage 1 - Special Alloy	20.8 mm 28.0 mm	16.51 mm 20.8 mm	90 lbs @37 mm	200 lbs @27 mm	279 lbs	23 mm	12 mm
This Spring requires Ferrea Titanium Retainer #E11073 and BOTH, Ferrea Spring Seat Locator # SL1061 and Factory supplied Spring Seat Locator.								
S10108	Dual Spring - Turbo Stage 2 - Special Alloy	20.8 mm 28.0 mm	15.88 mm 20.8 mm	105 lbs @37 mm	235 lbs @27 mm	330 lbs	23.5 mm	12 mm
This Spring requires Ferrea Titanium Retainer #E11074 and BOTH, Ferrea Spring Seat Locator # SL1062 and Factory supplied Spring Seat Locator.								
FORD ESCORT 2.0L - DOHC ZETEC 16 VALVE (ZX2) - 1999-2001								
FORD FOCUS 2.0L - DOHC ZETEC 16 VALVE (ZX3) - 2000-2001								
S10040	Single Spring Special Alloy	24.70 mm	18.23 mm	60 lbs @ 31.5 mm	140 lbs @ 21.5 mm	203 lbs	18.5 mm	12.5 mm
This Spring requires Ferrea Titanium Retainer #E11018 and BOTH, Ferrea Spring Seat Locator #SL1014 and Factory supplied Spring Seat Locator.								
S10041	Dual Spring - Turbo Special Alloy -	18.23 mm 24.70 mm	13.40 mm 18.23 mm	75 lbs @ 32.75 mm	195 lbs @ 22.75 mm	305 lbs	18.75 mm	13.5 mm
This Spring requires Ferrea Titanium Retainer #E11018 and Ferrea Spring Seat Locator #SL1015 (Discard OEM Spring Seat Locator) NOTE: This Spring (#S10041) can be used only with Ferrea Manganese Bronze Valve Guides (for 5.5 mm valve stem) #VG1006 (Intake) and #VG1007 (Exhaust) and Ferrea Valve Seals #VS1000 (Exhaust) and VS1001 (intake).								
FORD ECOBOOST 2.3L - DOHC 16 VALVE - 2015								
S10163	Single Spring PAC Alloy - Turbo Endurance Application	24.61 mm	17.40 mm	75 lbs @37.75mm	160 lbs @27.75mm	215.7 lbs	23.78mm	12.7mm
This spring requires Ferrea Titanium Retainer # E11135 and Ferrea Spring Seat Locator / Valve Hat Seal # SL1147. (Discard OEM Factory supplied Spring Seat Locator / Valve Hat Seal)								
GEO METRO/SUZUKI SWIFT 1.0 L - SOHC 6 VALVE (G10) - 1995-2001								
S10047	Dual Spring - Turbo Special Alloy	18.23 mm 24.70 mm	13.40 mm 18.23 mm	70 lbs @ 35.5 mm	175 lbs @ 25.5 mm	266 lbs	18.75 mm	14 mm
This Spring requires Ferrea Titanium Retainer # E11024 and Ferrea Spring Seat Locator #SL1018 (Discard OEM Spring Seat Locator)								
GM 2.2 ECO TEC - 2000-2008								
S10057	Dual Spring - Turbo Special Alloy	20.8 mm 28 mm	16.51 mm 20.8 mm	75 lbs @ 32.5 mm	175 lbs @ 22.5 mm	254 lbs	17.5 mm	14 mm
This Spring requires Ferrea Titanium Retainer # E11033 and Factory supplied Spring Seat Locator NOTE: For High Pressure use Both Ferrea Spring Seat Locator #SL1028 And Factory supplied Spring Seat Locator High Pressure spec. 110 lbs @ 31 mm 210 lbs @ 21 mm								
GM 5 CYLINDER - L5 - 2002-2006								
S10058	Dual Spring - Turbo Special Alloy	20.8 mm 28 mm	16.51 mm 20.8 mm	85 lbs @ 32 mm	185 lbs @ 22 mm	254 lbs	17.5 mm	13.5 mm
This Spring requires Ferrea Titanium Retainer # E11034 and both, Ferrea Spring Seat Locator #1027 and Factory supplied Spring Seat Locator.								
HIGH PRESSURE SPRINGS (SPECIAL APPLICATIONS)								
S10063	Dual Spring Special Alloy	22.6 mm 30.86 mm	16.55 mm 22.6 mm	150 lbs @35.6 mm	450 lbs @19 mm	462 lbs	18 mm	16.5 mm
Maximum Retainer step 1.9 mm								
S10109	Dual Spring - Turbo High Pressure PAC Alloy	20.8 mm 28.0 mm	15.88 mm 20.8 mm	100 lbs @ 33 mm	261 lbs @ 20.32 mm	322 lbs	17.63 mm	14 mm
Maximum Retainer step 2.54 mm								
HONDA ACCORD LX 2.4L - DOHC i-VTEC 16 VALVE (K24Z2) - 2008-2012								
HONDA CIVIC Si 2.4L - DOHC i-VTEC 16 VALVE (K24Z7) - 2012-2015								
S10164	Dual Spring-PAC Enhanced Drag / Enduro Racing	23.1 mm 31 mm	17.35 mm 23.1 mm	105 lbs @39 mm	225 lbs @29 mm	305 lbs	22 mm	15 mm
This Spring requires Ferrea Titanium Retainer # E11141 and Ferrea Spring Seat Locator # SL1149 (Discard OEM Spring Seat Locator)								
HONDA CIVIC 1.6L - SOHC 16 VALVE (D16Z6-Y5-Y7-Y8) - 1992-2000								
S10029	Single Spring Special Alloy	22.9 mm	15.35 mm	60 lbs @ 50 mm	155 lbs @ 40 mm	241 lbs	32 mm	17 mm
This Spring requires Ferrea Titanium Retainer # E11010 and Factory supplied Spring Seat Locator (Use only this locator)								

VALVE SPRINGS

Part#	Type/Material/ Application	O.D.	I.D.	Seat Press.	Open Press.	Rate Inch	Coil Bind	Max Net Lift
HONDA DEL SOL 1.6L - DOHC VTEC 16 VALVE (B16A1) - 1994-1997								
HONDA CIVIC SI 1.6L - DOHC VTEC 16 VALVE (B16A3) - 1999-2000								
S10027	Dual Spring - Hi Pressure Special Alloy	22.8 mm 30.10 mm	17.15 mm 22.88 mm	100 lbs @ 34 mm	220 lbs @ 24 mm	305 lbs	20 mm	13.5 mm
This Spring requires Ferrea Titanium Retainer # E11000 and Ferrea Spring Seat Locator # SL1003 (Discard OEM Spring Seat Locator)								
S10064	Dual Spring - Turbo Special Alloy- Hi Pressure	22.88 mm 30.10 mm	17.15 mm 22.88 mm	95 lbs @34 mm	215 lbs @24 mm	305 lbs	19 mm	14 mm
This Spring requires Ferrea Titanium Retainer # E11000 and Ferrea Spring Seat Locator # SL1000 (Discard OEM Spring Seat Locator)								
S10070	Dual Spring - Special Alloy Endurance Spring	22.85 mm 30.45 mm	17.5 mm 22.85 mm	80 lbs @33 mm	190 lbs @23 mm	279 lbs	18 mm	14 mm
This Spring requires Ferrea Titanium Retainer # E11000 and Ferrea Spring Seat Locator # SL1004 (Discard OEM Spring Seat Locator). Maximum Retainer Step: 3.6 mm								
S10086	Dual Spring Special Alloy Endurance Application	22.85mm 30.45mm	17.5mm 22.85mm	110 lb @ 34mm	260 lb @ 21mm	292 lbs	20 mm	13 mm
This Spring requires Ferrea Titanium Retainer # E11000 and Ferrea Spring Seat Locator # SL1044 (Discard OEM Spring Seat Locator) This Spring requires Ferrea Roller Rocker System # RR1000								
S10104	Dual Spring - Turbo - PAC enhanced Alloy	23.10 mm 30mm	17.2mm 23.10mm	80 lbs @34 mm	195 lbs @24 mm	292 lbs	20 mm	13.5 mm
This Spring requires Ferrea Titanium Retainer # E11000 OR E11000LW and Ferrea Spring Seat Locator # SL1000 (Discard OEM Spring Seat Locator)								
HONDA CIVIC TYPE-R 2.0L - DOHC VTEC 16 VALVE (K20C1-TURBO) - 2017-2018								
S10165	Single Spring - Turbo Special Alloy Endurance Application INTAKE ASSEMBLY	23.5mm	15.7mm	75 lbs @ 46.3 mm	185 lbs @ 36.3 mm	279 lbs	33.3 mm	12 mm
	EXHAUST ASSEMBLY			75 lbs @ 44.3 mm	185 lbs @ 34.3 mm	279 lbs	31.3 mm	12 mm
This Spring requires Ferrea Tool Steel Retainer # E20056 and Ferrea Spring Seat #SL1152 (EXH Side) and Ferrea Spring Seat Locator # SL1151 (INT Side). (Discard OEM Spring Seat Locator)								
S10166	Single Spring - Turbo Special Alloy Drag Application **Can only be used with Ferrea Roller Rocker Kit # RR1006** INTAKE ASSEMBLY	22.9mm	15.35mm	75 lbs @ 51.85 mm	182 lbs @ 41.85 mm	272 lbs	35.6 mm	15.25 mm
	EXHAUST ASSEMBLY			75 lbs @ 49.85 mm	182 lbs @ 39.85 mm	272 lbs	33.6 mm	15.25 mm
This Spring requires Ferrea Titanium Retainer # E11142 and Ferrea Spring Seat #SL1154 (EXH Side) and Ferrea Spring Seat Locator # SL1153 (INT Side). (Discard OEM Spring Seat Locator)								
HONDA PRELUDE 2.2L - DOHC VTEC 16 VALVE (H22A1-A4) - 1993-2000								
S10027	Dual Spring - Hi Pressure Special Alloy	22.88 mm 30.10 mm	17.15 mm 22.88 mm	100 lbs @ 34 mm	220 lbs @ 24 mm	305 lbs	20 mm	13.5 mm
This Spring requires Ferrea Titanium Retainer # E11000 and Ferrea Spring Seat Locator # SL1003 (Discard OEM Spring Seat Locator)								
S10064	Dual Spring - Turbo Special Alloy- Hi Pressure	22.88 mm 30.10 mm	17.15 mm 22.88 mm	95 lbs @34 mm	215 lbs @24 mm	305 lbs	19 mm	14 mm
This Spring requires Ferrea Titanium Retainer # E11000 and Ferrea Spring Seat Locator # SL1000 (Discard OEM Spring Seat Locator)								
S10070	Dual Spring - Special Alloy Endurance Spring	22.85 mm 30.45 mm	17.5 mm 22.85 mm	80 lbs @33 mm	190 lbs @23 mm	279 lbs	18 mm	14 mm
This Spring requires Ferrea Titanium Retainer # E11000 and BOTH, Ferrea Spring Seat Locator # SL1003 AND Factory supplied Spring Seat Locator.								
S10104	Dual Spring - Turbo - PAC enhanced Alloy	23.10 mm 30mm	17.2mm 23.10mm	80 lbs @34 mm	195 lbs @24 mm	292 lbs	20 mm	13.5 mm
This Spring requires Ferrea Titanium Retainer # E11000 OR E11000LW and Ferrea Spring Seat Locator # SL1003 (Discard OEM Spring Seat Locator)								
HONDA S 2000 - F20C - 2000-2003								
HONDA S 2000 - F22C - 2004-2008								
S10074	Dual Spring - Special Alloy Turbo - Endurance Spring	22.85 mm 30.45 mm	17.5 mm 22.85 mm	90 lbs @42 mm	210 lbs @32 mm	292 lbs	28 mm	13 mm
This Spring requires Ferrea Titanium Retainer # E11045 and Ferrea Spring Seat Locator # SL1035 AND Factory supplied Spring Seat Locator.								

VALVE SPRINGS

Part#	Type/Material/ Application	O.D.	I.D.	Seat Press.	Open Press.	Rate Inch	Coil Bind	Max Net Lift
HYUNDAI GENESIS 2.0L - DOHC 16 VALVE (TURBO BK) - 2008-2010								
S10118	Dual Spring - Turbo	20.8 mm	16.51 mm	75 lbs.	175 lbs	254 lbs	(*)	12 mm
	Special Alloy	28 mm	20.8 mm	@36 mm	@26 mm			
This spring requires Ferrea Titanium Retainer # E11089 AND Ferrea Spring Seat Locator # SL1096 AND OEM Factory supplied Spring Seat Locator.								
NOTE: (*) Max Net Lift is limited by the OEM Factory hat style seat/seal locator height, so Spring Coil Bind does not apply.								
HYUNDAI GENESIS COUPE V-6 3.8L - DOHC 24 VALVE (LAMBDA) - 2010								
S10134	Single Spring	25.19 mm	18.3 mm	90 lbs	152 lbs	157 lbs	21.6 mm	12.5 mm
	Special Alloy			@34.85 mm	@24.85 mm			
	Endurance Spring							
This Spring requires Ferrea Titanium Retainer # E11105 and OEM Spring Seat Locator								
INFINITI V6 3.0L - DOHC 24 VALVE (VR30DDTT) - 2015-2018								
S10169	Single Spring	25.19 mm	18.3 mm	80 lbs	145 lbs	165 lbs	23.75 mm	13 mm
	Special Alloy			@37.5 mm	@27.5 mm			
This Spring requires Ferrea Titanium Retainer # E12032 and Ferrea Spring Seat Locator # SL1161.								
Discard OEM Factory supplied Spring Seat Locator.								
LAMBORGHINI V10 5.0L - DOHC 40 VALVE - 2003-2007								
S10160	Single Spring - Turbo	22.38 mm	15.52 mm	80 lbs	185 lbs	244 lbs	25.6	11 mm
	PAC Enhanced Alloy			@37.9	@27			
This spring requires Ferrea Titanium Retainer # E11132 and Ferrea Spring Seat Locator # SL1143								
NOTE: Max Net Lift is limited due to the OEM factory valve seal install height.								
LOTUS ELISE / EXIGE 1.8L - DOHC 16 VALVE (ZZZ-GE) - 2008								
S10123	Dual Spring - Endurance	19.05 mm	13.95 mm	75 lbs	180 lbs	274 lbs	24 mm	13.5 mm
	Special Alloy	25.30 mm	19.05 mm	@ 38.5 mm	@ 28.5 mm			
This Spring requires Ferrea Titanium Retainer # E11097 and Ferrea Spring Seat Locator # SL1105 (Discard OEM Spring Seat Locator)								
MITSUBISHI 3000 GT 3.0L - DOHC 24 VALVE (6G72-TURBO 6G72T) - 1990-2001								
S10037	Dual Spring - Turbo -	23.10 mm	17.2mm	80 lbs	195 lbs	292 lbs	20 mm	13.5 mm
	PAC enhanced Alloy	30mm	23.10mm	@34 mm	@24 mm			
This Spring requires Ferrea Titanium Retainer # E11053 and Ferrea Spring Seat Locator # SL1008 (Discard OEM Spring Seat Locator)								
MITSUBISHI ECLIPSE GS-GST 2.0L - DOHC 16 VALVE (4G63-4G63T) - 1990-1999								
S10031	Dual	23.1 mm	17.35 mm	90 lbs	210 lbs	305 lbs	21 mm	15 mm
	Chrome Silicon	31 mm	23.1 mm	@ 38 mm	@ 28 mm			
This Spring requires Ferrea Titanium Retainer # E11005 and Ferrea Spring Seat Locator # SL1002 (Discard OEM Spring Seat Locator)								
S10036	Dual Spring - Turbo	22.75 mm	17.1 mm	80 lbs	180 lbs	254 lbs	20 mm	13.5 mm
	Special Alloy	29.5 mm	22.75 mm	@ 34 mm	@ 24 mm			
This Spring requires Ferrea Titanium Retainer # E11005 and Ferrea Spring Seat Locator # SL1009 (Discard OEM Spring Seat Locator)								
MITSUBISHI EVOLUTION VIII 2.0L - DOHC 16 VALVE (TURBO 4G63T) - 2003-2007								
S10084	Dual Spring - Turbo	22.85 mm	17.5 mm	95 lbs	225 lbs	327 lbs	18 mm	12.5 mm
	Special Alloy	30.45 mm	22.85 mm	@30.6 mm	@20.6 mm			
This Spring requires Ferrea Titanium Retainer # E11052 and Ferrea Spring Seat Locator # SL1041.								
MITSUBISHI EVOLUTION X 2.0L - DOHC 16 VALVE (4B11T) - 2007-2009								
S10118	Dual Spring-Endurance	20.8 mm	16.51 mm	75 lbs	175 lbs	254 lbs	(*)	12 mm
	Special Alloy	28 mm	20.8 mm	@36 mm	@26 mm			
This Spring requires Ferrea Titanium Retainer #E11089 AND Ferrea Spring Seat Locator #SL1096 AND OEM Factory supplied Spring Seat Locator.								
NOTE: (*)Max Net Lift is limited by the OEM Factory hat style seat/seal locator height, so Spring Coil Bind does not apply.								
NISSAN 300 ZX 3.0L - DOHC 24 VALVE (VG30D-TURBO VG30DDTT) - 1990-1996								
S10039	Dual Spring	20.8 mm	15.3 mm	80 lbs	200 lbs	305 lbs	22 mm	13 mm
	Chrome Silicon	28.0 mm	20.8 mm	@ 35 mm	@ 25 mm			
This Spring requires Ferrea Titanium Retainer # E11017 and BOTH Ferrea Spring Seat Locator # SL1012 and Factory supplied Spring Seat Locator								
NISSAN 350 Z 3.5 L - V-6 - DOHC 24 VALVE (VQ35) - 2003-2008								
S10091	Single Spring	25.19mm	18.3mm	75 lbs	145 lbs	178 lbs	20.5 mm	12.5 mm
	Special Alloy - Turbo			@34.8mm	@24.8mm			
	Endurance Application							
This Spring to be used with Factory Valves with recess tip and Ferrea Titanium Retainer # E11060 AND Factory supplied Spring Seat Locator								
NISSAN 350 Z 3.5 L - V-6 - DOHC 24 VALVE (VQ35) - 2003-2008								
S10093	Single Spring	25.19mm	18.3mm	85 lbs	155 lbs	178 lbs	20.5 mm	12.5 mm
	Special Alloy - Turbo			@34mm	@24mm			
	Endurance Application							
This Spring to be used with Ferrea Lightweight Valves without recess tip and Ferrea Titanium Retainer # E11058 AND Ferrea Spring Seat Locator # SL1048								
S10103	Dual Spring -	20.8 mm	15.88mm	80 lbs	200 lbs	305 lbs	19 mm	13 mm
	Special Alloy - Turbo	28.0 mm	20.8 mm	@34mm	@24mm			
	Street/Drag							
This Spring to be used with Ferrea lightweight Valves without recess tip.								
This spring requires Ferrea Titanium Retainer #E11079 AND Ferrea Spring Seat Locator #SL1065. (Discard OEM Spring Seat Locator).								

VALVE SPRINGS

Part#	Type/Material/ Application	O.D.	I.D.	Seat Press.	Open Press.	Rate Inch	Coil Bind	Max Net Lift
-------	-------------------------------	------	------	----------------	----------------	--------------	--------------	-----------------

NISSAN ALTIMA 2.4L - DOHC 16 VALVE (KA24DE) - 1995-1999

NISSAN 240 SX 2.4L - DOHC 16 VALVE (KA24DE) - 1991-1998

S10043	Dual Spring - Turbo	23.10 mm	17.2 mm	80 lbs	195 lbs	254 lbs	22 mm	12.5 mm
	PAC enhanced Alloy	30 mm	23.10 mm	@36 mm	@26 mm			

This Spring requires Ferrea Titanium Retainer # E11021 and BOTH Ferrea Spring Seat Locator #SL1064 and Factory supplied Spring Seat Locator

NISSAN GT-R 3.8 L V-6 - DOHC 24 VALVE (VR38DETT) - 2009-2010

S10136	Dual Spring - Turbo	20.8 mm	15.88 mm					
	Special Alloy	28.0 mm	20.8 mm					
	INTAKE ASSEMBLY			90 lbs	212 lbs	309.6 lbs	23.5 mm	13 mm
				@37.5 mm	@27.5 mm			
	EXHAUST ASSEMBLY			90 lbs	212 lbs	309.6 lbs	19.6 mm	13.5 mm
				@34.35 mm	@24.35 mm			

This Spring requires Ferrea Titanium Retainer # E11106 and Ferrea Spring Seat Locator #SL1118 (EXH Side) and Ferrea Spring Seat Locator #SL1115 (INT Side). (Discard OEM Spring Seat Locator)

S10137	Single Spring	25.19 mm	18.3 mm	90 lbs	160 lbs	177 lbs	22.65 mm	11 mm
	Special Alloy			@35 mm	@25 mm			

This Spring requires 2 Ferrea Titanium Retainer (EXHAUST) # E11110 and (INTAKE) # E11107 and Ferrea Spring Seat Locator # SL1116. Discard OEM Factory supplied Spring Seat Locator.

NISSAN PATROL 4.5L 6 CYL IN LINE - 12 VALVE - (TB45E) - 1997-2004

S10128	Dual Spring - Chr Silicon	23.1 mm	17.35 mm	70 lbs	195 lbs	317 lbs	20.5 mm	14.15 mm
	Endurance	31 mm	23.1 mm	@40.6mm	@30.6mm			

This Spring requires Ferrea Titanium Retainer # E11102 and Ferrea Spring Seat Locator # SL1111
Discard OEM Factory supplied Spring Seat Locator.

NISSAN PATROL 4.8L 6 CYL IN LINE - 24 VALVE - (TB48DE) - 2004-2010

S10114	Dual Spring - Turbo	20.8 mm	16.51 mm	85 lbs	190 lbs	266 lbs	22.85 mm	12 mm
	Special Alloy	28.0 mm	20.8 mm	@36.85mm	@26.85mm			

This Spring requires Ferrea Titanium Retainer # E11083 and Ferrea Spring Seat Locator # SL1070
Discard OEM Factory supplied Spring Seat Locator.

S10133	Single Spring	28.0 mm	20.8 mm	73 lbs	155 lbs	208 lbs	22.85 mm	12 mm
	Special Alloy			@35.85 mm	@25.85 mm			

This Spring requires Ferrea Titanium Retainer # E11109 and Ferrea Spring Seat Locator # SL1070
Discard OEM Factory supplied Spring Seat Locator.

NISSAN SENTRA SE-R 2.0L - DOHC 16 VALVE (SR20DE-SR20DET) - 1991-1998

S10038	Dual Spring - Turbo	23.10 mm	17.2 mm	80 lbs	195 lbs	254 lbs	22 mm	12.5 mm
	PAC enhanced Alloy	30 mm	23.10 mm	@ 34 mm	@ 24 mm			

This Spring requires Ferrea Titanium Retainer # E11002 and Ferrea Spring Seat Locator # SL1011
(Discard OEM Spring Seat Locator)

NISSAN SKYLINE 6 CYL IN LINE - 24 VALVE - (RB25DET) - 1993-1997

S10112	Dual Spring - Turbo	20.8 mm	16.51 mm					
	Special Alloy	28.0 mm	20.8 mm					
	INTAKE ASSEMBLY			110 lbs	215 lbs	266 lbs	18 mm	10.5 mm
				@ 30.55 mm	@ 20.55 mm			
	EXHAUST ASSEMBLY			90 lbs	190 lbs	254 lbs	21.5 mm	10.5 mm
				@ 34.50 mm	@ 24.50 mm			

This Spring requires Ferrea Titanium Retainer # E11082 and Ferrea Spring Seat Locator #SL 1068 (EXH Side) and Ferrea Spring Seat Locator #SL1069 (INT Side). (Discard OEM Spring Seat Locator) WARNING: DUE TO VALVETRAIN ASSEMBLY INSTALLED HIEGHTS, MAXIMUM VALVE NET LIFT MUST NOT EXCEED 10.5 MM BECAUSE OF VALVE SEAL TO SPRING RETAINER CLEARANCES.

NISSAN SKYLINE 6 CYL IN LINE - 24 VALVE (NEO) - 1998-2002

S10078	Dual Spring - Turbo	20.8 mm	16.51 mm	95 lbs	195 lbs	254 lbs	17.5 mm	12 mm
	Special Alloy	28.0 mm	20.8 mm	@30 mm	@20 mm			

This Spring requires Ferrea Titanium Retainer # E11048 and BOTH Ferrea Spring Seat Locator # SL1037 (INT) and #SL1150 (EXH) AND Factory supplied Spring Seat Locator. Maximum Retainer Step 2 mm

VALVE SPRINGS

Part#	Type/Material/ Application	O.D.	I.D.	Seat Press.	Open Press.	Rate Inch	Coil Bind	Max Net Lift
NISSAN SKYLINE 6 CYL IN LINE - 24 VALVE - (RB26) - 1989-2002								
S10090	Dual Spring - Turbo	20.8 mm	16.51 mm	110 lbs	210 lbs	254 lbs	26.5 mm	12 mm
	Special Alloy	28.0 mm	20.8 mm	@39mm	@29mm			
This Spring requires Ferrea Titanium Retainer # E11057 and Ferrea Spring Seat Locator # SL1047 (Discard OEM Spring Seat Locator)								
PORSCHE 996TT 3.6L - FLAT 6 CYL - DOHC 24 VALVE - 2000-2005								
S10122	Dual Spring - Turbo	20.8 mm	15.88 mm	98 lbs.	220 lbs	309 lbs	20.0 mm	11.2 mm
	Special Alloy	28 mm	20.8 mm	@33.5 mm	@24.5 mm			
This spring requires Ferrea Titanium Retainer # E11094 AND Ferrea Spring Seat Locator # SL1099. (Discard OEM Spring Seat Locators) NOTE: Ferrea Seat Locators must be installed before valve seal installation and Max Net Lift is limited to 11.20mm due to spring retainer and valve seal clearance.								
SCION tC 2.4L - DOHC 16 VALVE (2AZFE) - 2005								
S10110	Single Spring - Turbo	25.19 mm	18.3 mm	80 lbs	150 lbs	180 lbs	20.5 mm	12.5 mm
	Special Alloy			@34.2 mm	@24.2 mm			
	Endurance Spring							
This Spring requires Ferrea Titanium Retainer # E11075 and Ferrea Spring Seat Locator # SL1063 (Discard OEM Spring Seat Locator)								
SCION tC 2.5L - DOHC 16 VALVE (2ARFE) - 2011								
S10143	Single Spring	25.19 mm	18.3 mm	78 lbs.	160 lbs.	208 lbs	22.6 mm	14.5 mm
	Stage 1			@38.7mm	@28.7mm			
	Endurance Application							
This spring requires Ferrea Titanium Retainer # E11118 AND Ferrea Spring Seat Locator # SL1126. (Discard OEM Factory Spring Seat Locator)								
S10144	Dual Spring - Turbo	18.82 mm	13.84 mm	80 lbs.	180 lbs.	254 lbs	21.5 mm	13 mm
	Special Alloy	25.19 mm	18.82 mm	@35.7mm	@25.7mm			
	Stage 2							
	Road/Drag Application							
This spring requires Ferrea Titanium Retainer # E11117 AND Ferrea Spring Seat Locator # SL1126. (Discard OEM Factory Spring Seat Locator)								
SCION FR-S 2.0L - DOHC 16 VALVE (4U-GSE) - 2012-2015								
S10154	Single Spring - Endurance	28.0 mm	20.8 mm	60 lbs	135 lbs	190 lbs	18.6 mm	14.5 mm
	Special Alloy			@34 mm	@24 mm			
This Spring requires Ferrea Tool Steel Retainer #E20055, and Ferrea Spring Seat Locator #SL1139. (Discard OEM Factory Spring Seat Locator).								
S10155	Dual Spring - Turbo	20.8 mm	16.51 mm	70 lbs	170 lbs	254 lbs	18.6 mm	14.5 mm
	Special Alloy	28.0 mm	20.8 mm	@34 mm	@24 mm			
This Spring requires Ferrea Titanium Retainer #E11127, and Ferrea Spring Seat Locator #SL1140. (Discard OEM Factory Spring Seat Locator).								
SUBARU WRX 2.0L - DOHC 16 VALVE (EJ20) - 2001-2008								
S10071	Dual Spring -	20.8 mm	15.88 mm	75 lbs	200 lbs	317 lbs	21.5 mm	15 mm
	Special Alloy	28 mm	20.8 mm	@39.4 mm	@29.4 mm			
	Turbo - Drag Racing							
This Spring requires Ferrea Titanium Retainer # E11043 and Ferrea Spring Seat Locator # SL1034 (Discard OEM Spring Seat Locator)								
S10072	Dual Spring -	20.8 mm	16.51 mm	70 lbs	165 lbs	241 lbs	20 mm	15 mm
	Special Alloy Turbo	28 mm	20.8 mm	@39.4 mm	@29.4 mm			
	Endurance Spring							
This Spring requires Ferrea Titanium Retainer # E11044 and Ferrea Spring Seat Locator # SL1034 (Discard OEM Spring Seat Locator)								
SUBARU WRX 2.0L - DOHC 16 VALVE (STI) - 2004-2008								
S10097	Dual Spring-Special Alloy	20.8 mm	15.88 mm	90 lbs	215 lbs	317 lbs	21.5 mm	14 mm
	Turbo - Drag Racing	28 mm	20.8 mm	@36 mm	@26 mm			
This Spring requires Ferrea Titanium Retainer # E11064 and Ferrea Spring Seat Locator # SL1051 (Discard OEM Spring Seat Locator)								
S10098	Dual Spring-Special Alloy	20.8 mm	16.51 mm	80 lbs	180 lbs	254 lbs	21.0 mm	14 mm
	Turbo-Endurance Racing	28 mm	20.8 mm	@36 mm	@26 mm			
This Spring requires Ferrea Titanium Retainer # E11065 and Ferrea Spring Seat Locator # SL1051 (Discard OEM Spring Seat Locator)								
SUBARU BRZ 2.0L - DOHC 16 VALVE (FA20) - 2012-2015								
S10154	Single Spring - Endurance	28.0 mm	20.8 mm	60 lbs	135 lbs	190 lbs	18.6 mm	14.5 mm
	Special Alloy			@34 mm	@24 mm			
This Spring requires Ferrea Tool Steel Retainer #E20055, and Ferrea Spring Seat Locator #SL1139. (Discard OEM Factory Spring Seat Locator).								
S10155	Dual Spring - Turbo	20.8 mm	16.51 mm	70 lbs	170 lbs	254 lbs	18.6 mm	14.5 mm
	Special Alloy	28.0 mm	20.8 mm	@34 mm	@24 mm			
This Spring requires Ferrea Titanium Retainer #E11127, and Ferrea Spring Seat Locator #SL1140. (Discard OEM Factory Spring Seat Locator).								

VALVE SPRINGS

Part#	Type/Material/ Application	O.D.	I.D.	Seat Press.	Open Press.	Rate Inch	Coil Bind	Max Net Lift
TOYOTA 4AG 1.6L - DOHC 16 VALVE (ATLANTIC) - 1983-1988								
S10080	Single Spring - Special Alloy	23.5 mm	16.46 mm	40 lbs @35 mm	120 lbs @25 mm	203 lbs	22 mm	12 mm
This Spring requires Ferrea Titanium Retainer # E11046 and Factory supplied Spring Seat Locator.								
TOYOTA 4AGELU 1.6L - DOHC 20 VALVE - 1995-1998								
S10150	Single Spring - Endurance Special Alloy	20.32 mm	14.23 mm	40 lbs @37 mm	133 lbs @27 mm	236 lbs	25.15 mm	11 mm
This Spring requires Ferrea Tool Steel Retainer # E20052, Ferrea Valve Locks #K10106 and Ferrea Spring Seat Locator #SL1133. (Discard OEM Factory Spring Seat Locator). TECH NOTE: Ferrea Pro Springs are designed with progressive wound coils. Assemble stacked coils of spring at the bottom, on top of spring seat locator.								
TOYOTA 1.8L DOHC 16 VALVE (ZZZGE) 2003-2006								
S10123	Dual Spring - Endurance Special Alloy	19.05 mm 25.30 mm	13.95 mm 19.05 mm	70 lbs @38.5 mm	178 lbs @28.5 mm	274 lbs	24 mm	13.5 mm
This Spring requires Ferrea Titanium Retainer # E11097 and Ferrea Spring Seat Locator # SL1105 (Discard OEM Factory supplied Spring Seat Locator)								
TOYOTA MR2 2.0L - DOHC 16 VALVE (TURBO 3SGTE) - 1990-1995								
S10034	Dual Chrome Silicon	20.8 mm 28.0 mm	16.51 mm 20.8 mm	65 lbs @ 35 mm	185 lbs @ 25 mm	305 lbs	20 mm	14 mm
This Spring requires Ferrea Titanium Retainer # E11011 and BOTH, Ferrea Spring Seat Locator # SL1007 and Factory supplied Spring Seat Locator.								
TOYOTA MR2 2.0L - DOHC 16 VALVE (3SGTE GEN3) - 1996-1998								
S10151	Dual Spring - Endurance Special Alloy	20.8 mm 28 mm	16.51 mm 20.8 mm	80 lbs @37.6 mm	178 lbs @27.6 mm	249 lbs	25.1 mm	11.5 mm
This Spring requires Ferrea Titanium Retainer # E11123 and Ferrea Spring Seat Locators # SL1134. Discard OEM Factory Spring Seat Locator.								
TOYOTA 2.0 L - DOHC 16 VALVE (3SGE)								
S10073	Dual Spring - Turbo Special Alloy	20.8 mm 28.0 mm	15.88 mm 20.8 mm	87 lbs @34 mm	195 lbs @24 mm	285 lbs	21.5 mm	12.5 mm
This Spring requires Ferrea Titanium Retainer # E11042 and Ferrea Spring Seat Locator # SL1032 (Discard OEM Spring Seat Locator)								
TOYOTA FJ CRUISER V6 4L - DOHC 24 VALVE (1GR-FE) - 2006-2008								
S10127	Double Spring-Special Alloy Endurance	20.8 mm 28.0 mm	16.51 mm 20.8 mm	75 lbs @ 35.65 mm	175 lbs @25.65 mm	254 lbs	20 mm	13 mm
This Spring requires Ferrea Titanium Retainer # E11100 and Ferrea Spring Seat Locator # SL1110 (Discard OEM Spring Seat Locator)								
S10132	Single Spring-Special Alloy Endurance	25.19mm	18.30 mm	80 lbs @ 36 mm	145 lbs @ 26 mm	165 lbs	21 mm	13 mm
This Spring requires Ferrea Titanium Retainer # E11104 and OEM Spring Seat Locator								
TOYOTA LANDCRUISER 4.5L - DOHC 24 VALVE (1FZFE) - 1993-1997								
S10126	Double Spring-Special Alloy Endurance	20.8 mm 28.0 mm	16.51 mm 20.8 mm	75 lbs @33 mm	175 lbs @23 mm	254 lbs	17 mm	16 mm
This Spring requires Ferrea Titanium Retainer # E11096 and Ferrea Spring Seat Locator # SL1109 (Discard OEM Factory supplied Spring Seat Locator)								
S10131	Single Spring-Special Alloy	28 mm	20.8 mm	67 lbs @31 mm	150 lbs @21 mm	210 lbs	17 mm	13 mm
This Spring requires OEM Steel Retainers and Ferrea Spring Seat Locator # SL1114 (Discard OEM Factory supplied Spring Seat Locator)								
TOYOTA SUPRA 3.0L I/L 6 CYL - DOHC 24 VALVE (2JZGE-2JZGTE) - 1994-1998								
S10178	Dual Spring - Turbo PAC Enhanced - Special Alloy	20.12 mm 27.13 mm	14.78 mm 20.12 mm	90 lbs @33 mm	215 lbs @23 mm	317 lbs	19.95 mm	12 mm
This Spring requires Ferrea Titanium Retainer # E11145 and Ferrea Seat Locator # SL1173 (Discard OEM Spring Seat Locator)								
S10179	Dual Spring - Turbo PAC Enhanced - Special Alloy	20.12 mm 27.13 mm	14.78 mm 20.12 mm	125 lbs @33 mm	250 lbs @23 mm	317 lbs	20.20 mm	11.5 mm
This Spring requires Ferrea Titanium Retainer # E11145 and Ferrea Seat Locator # SL1174 (Discard OEM Spring Seat Locator)								
TOYOTA SUPRA 3.0L - DOHC 24 VALVE (7MGE-TURBO 7MGTE) - 1986-1992								
S10120	Dual Spring - Endurance Special Alloy	19.05 mm 25.30 mm	13.95 mm 19.05 mm	70 lbs @ 34 mm	180 lbs @ 24 mm	280 lbs	20 mm	13 mm
This Spring requires Ferrea Titanium Retainer # E11095 and Ferrea Spring Seat Locator # SL1104 (Discard OEM Spring Seat Locator)								

VALVE SPRINGS

Part#	Type/Material/ Application	O.D.	I.D.	Seat Press.	Open Press.	Rate Inch	Coil Bind	Max Net Lift
TOYOTA SUPRA 3.0L - DOHC 24 VALVE (B58) TURBO - 2019								
S10177	Single Spring PAC Enhanced - Special Alloy INTAKE ASSEMBLY	22.53 mm	15.52 mm	70 lbs @39 mm	175 lbs @29 mm	253 lbs	26 mm	11.5 mm
	EXHAUST ASSEMBLY			85 lbs @37.7 mm	185 lbs @27.7 mm	253 lbs	26 mm	11 mm
This Spring requires BOTH Ferrea Titanium Retainers # E11146 (EXH) and # E11147 (INT) and BOTH Ferrea Hat Seat Locators # SL1175 (EXH) and # SL1176 (INT). (Discard OEM Spring Hat Seat Locator)								
WARNING: DUE TO VALVETRAIN ASSEMBLY INSTALLED HEIGHTS, MAXIMUM VALVE NET LIFTS MUST NOT EXCEED THE RECOMMENDED AMOUNTS BECAUSE OF VALVE SEAL TO SPRING RETAINER CLEARANCES.								
TOYOTA GT86 2.0L - DOHC 16 VALVE (4U-GSE) EUROPE - 2012-2015								
S10154	Single Spring - Endurance Special Alloy	28.0 mm	20.8 mm	60 lbs @34 mm	135 lbs @24 mm	190 lbs	18.6 mm	14.5 mm
This Spring requires Ferrea Tool Steel Retainer #E20055, and Ferrea Spring Seat Locator #SL1139. (Discard OEM Factory Spring Seat Locator).								
S10155	Dual Spring - Turbo Special Alloy	20.8 mm 28.0 mm	16.51 mm 20.8 mm	70 lbs @34 mm	170 lbs @24 mm	254 lbs	18.6 mm	14.5 mm
This Spring requires Ferrea Titanium Retainer #E11127, and Ferrea Spring Seat Locator #SL1140. (Discard OEM Factory Spring Seat Locator).								
VW 1.8T - DOHC 20 VALVE - 1998-2005								
S10055	Single Spring - Turbo Special Alloy (Intake - 12 pieces)	21.5 mm	15.1 mm	65 lbs @34.5 mm	145 lbs @24.5 mm	216 lbs	22.5 mm	11 mm
This Spring requires Ferrea Titanium Retainer # E11031 and Ferrea Spring Seat Locator # SL1025. (Discard OEM Spring Seat Locator)								
S10056	Dual Spring - Turbo Special Alloy (Exhaust - 8 pieces)	22.75 mm 29.5 mm	17.1 mm 22.75 mm	80 lbs @32.5 mm	180 lbs @22.5 mm	254 lbs	20 mm	12 mm
This Spring requires Ferrea Titanium Retainer # E11032 and Ferrea Spring Seat Locator # SL1026. (Discard OEM Spring Seat Locator)								
VW BEETLE/GOLF/JETTA/RABBIT 2.5L - DOHC 20 VALVE (BTW) - 2005 1/2 - 2009								
S10162	Single Spring - PAC Enhanced Alloy Endurance Application	22.38mm	15.52mm	80 lbs @37mm	180 lbs @27mm	254 lbs	24.6mm	11mm
This Spring requires Ferrea Ferrea Titanium Retainer # E11134, and Ferrea Spring Seat Locator # SL1145. (Discard OEM factory supplied Spring Seat Locator) NOTE: Max Net Lift is limited due to the OEM factory valve seal install height.								
VW GOLF / JETTA 1.8 L - DOHC 16 VALVE (PL) - 1987-1989								
VW SCIROCCO 1.8 L - DOHC 16 VALVE (PL) - 1986-1988								
S10115	Dual Spring Special Alloy Endurance Application	22.75 mm 29.5 mm	17.1 mm 22.75 mm	85 lbs @33 mm	205 lbs @23 mm	304 lbs	17.5 mm	14 mm
This Spring requires Ferrea Titanium Retainer # E11084 and Ferrea Seat Locator #SL1073 (Discard OEM Spring Seat Locator)								
VW GOLF / JETTA 1.8 L - DOHC 16 VALVE (9A) - 1990-1992								
VW PASSAT 2.0 L - DOHC 16 VALVE (9A) - 1990-1994								
S10115	Dual Spring Special Alloy Endurance Application	22.75 mm 29.5 mm	17.1 mm 22.75 mm	85 lbs @33 mm	205 lbs @23 mm	304 lbs	17.5 mm	14 mm
This Spring requires Ferrea Titanium Retainer # E11084 and Ferrea Seat Locator #SL1073 (Discard OEM Spring Seat Locator)								
VW VR6 2.8L - DOHC 12 VALVE - 1992-2002								
S10062	Dual Spring - Turbo Special Alloy	22.75 mm 29.5 mm	17.1 mm 22.75 mm	95 lbs @32 mm	195 lbs @22 mm	254 lbs	19 mm	13 mm
This Spring requires Ferrea Titanium Retainer # E11039								
VW VR6 2.8L - DOHC 24 VALVE (BDF) - 2002-2004								
S10087	Single Spring Special Alloy	23.5 mm	15.7 mm	85 lbs @39 mm	190 lbs @29 mm	265 lbs	26 mm	12 mm
This Spring requires Ferrea Titanium Retainer # E11063.								
VW VR6 R32 3.2L- DOHC 24 VALVE 2004-2011								
S10148	Dual Spring - Endurance Special Alloy	18.23 mm 25.19 mm	13.4 mm 18.23 mm	75 lbs @37.5 mm	180 lbs @27.5 mm	266 lbs	24.3 mm	12 mm
This Spring requires Ferrea Titanium Retainer # E11122 and BOTH Ferrea Spring Seat Locators # SL1131 & SL1132								
VW 2.0T TSI - DOHC 16 VALVE - 2009-2013								
VW GOLF R 2.0T TSI - DOHC 16 VALVE - 2015-2016								
S10157	Single Spring - Turbo PAC Enhanced Alloy INTAKE ASSEMBLY	22.38 mm	15.52 mm	80 lbs @ 37 mm	180 lbs @ 27 mm	254 lbs	24.6 mm	11 mm
	EXHAUST ASSEMBLY			85 lbs @ 36.5 mm	185 lbs @ 26.5 mm	254 lbs	24.6 mm	10.5 mm
This Spring requires Ferrea titanium Retainer (INTAKE) # E11139 and (EXHAUST) # E11140 and Ferrea Spring Seat Locator #SL1142. (Discard OEM Spring Seat Locator)								

TITANIUM RETAINERS

Part#	Val. Stem Size	Diam.(A)	Out Step Diam.(B)	In Step Diam.(C)	References
ACURA INTEGRA GSR 1.7L - DOHC VTEC 16 VALVE (B17A1) - 1992-1993					
ACURA INTEGRA GSR 1.8L - DOHC VTEC 16 VALVE (B18C1-C3) - 1994-2000					
E11000	5.5mm	28.20mm	22.85mm	17.15mm	Dble Spring-7deg Pro CNC Retainer. Ferrea Racing Spring #S10027, S10064, S10070, S10086, S10104 Ferrea Valve Lock K10034
E11000LW	5.5mm	28.20mm	22.85mm	17.15mm	Dble Spring-7deg Pro CNC Retainer. 7 grams Ferrea Racing Spring # S10070 OR S10104. Ferrea Valve Lock K10034
E12020	5.5 mm	21.6 mm	-	14.73 mm	Beehive Spring - Pro CNC Retainer Ferrea Racing Springs #S2014. Ferrea Valve Lock #K10034
ACURA INTEGRA LS-GS 1.8L - DOHC VTEC 16 VALVE (B18A1-BI) - 1990-2000					
HONDA CRV 2.0L - DOHC VTEC 16 VALVE (B20A-B20Z) - 1997-2000					
E11023	6.5 mm	27.95 mm	20.8 mm	15.7 mm	Dble Spring-7 deg Pro CNC Ferrea Racing Springs #S10046
ACURA RSX 2.0L - DOHC VTEC 16 VALVE (K20) - 2001-2006					
E11066	5.5 mm	27.10 mm	-	17.35 mm	Dble Spring-7 deg Pro CNC Ferrea Racing Springs #S10099 or #S10100 and Ferrea Valve Lock #K10034
E11125	5.5mm	27.94mm	-	17mm	Dble Spring-7deg Pro CNC-(16 pieces). Ferrea Racing Springs #S10149 Ferrea Valve Lock #K10034
E12027	5.5 mm	22.73 mm	-	14.60 mm	Beehive Spring - Pro CNC Retainer Ferrea Racing Springs #S2018. Ferrea Valve Lock #K10034
ACURA TSX 2.4L - DOHC i-VTEC 16 VALVE (K24Z3) - 2009-2014					
ACURA ILX 2.4L - DOHC i-VTEC 16 VALVE (K24Z7) - 2013-2015					
E11141	5.5mm	27.10 mm	-	17.35 mm	Dble Spring-7 deg Pro CNC Ferrea Racing Springs #S10164 Ferrea Valve Lock #K10034
AUDI 1.8T - DOHC 20 VALVE - 1996-2005					
E11031	6 mm	21 mm	-	15.15 mm	INT (12 pieces) Single Spring-7 deg Pro CNC Ferrea Racing Springs #S10055
E11032	6 mm	28.20 mm	22.85 mm	17.15 mm	EXH (8 pieces) Double Spring-7 deg Pro CNC Ferrea Racing Springs #S10056
AUDI 2.0T FSI - DOHC 16 VALVE - 2006-2008					
E11129	6 mm	20.32mm	-	15.74mm	Sggle Spring-7deg Pro CNC-(16 pieces). Ferrea Racing Springs #S10157 Use Factory OEM valve locks
AUDI 2.0T TSI - DOHC 16 VALVE - 2009-2013					
E11129	6 mm	20.32mm	-	15.74mm	Sggle Spring-7deg Pro CNC-(16 pieces). Ferrea Racing Springs #S10157 Use Factory OEM valve locks
E11139	6 mm	20.32 mm	-	15.75 mm	INT (8 pieces) Sggle Spring-7deg Pro CNC Ferrea Racing Springs #S10157 Use Factory OEM valve locks
E11140	6 mm	20.32 mm	-	15.75 mm	EXH (8 pieces) Sggle Spring-7deg Pro CNC Ferrea Racing Springs #S10157 Use Factory OEM valve locks
AUDI TTRS / RS3 2.5L TFSI - DOHC 20 VALVE (DAZA) TURBO - 2017-2018					
E12035	6 mm	20.32 mm	-	15.75 mm	Sggle Spring-7deg Pro CNC-(20 pieces) Ferrea Racing Springs #S10170 Use Factory OEM valve locks
AUDI 2.7T - DOHC 30 VALVE (APB) - 1998-2004					
E11031	6 mm	21 mm	-	15.15 mm	INT (18 pieces) Single Spring-7 deg Pro CNC Ferrea Racing Springs #S10055
E11032	6 mm	28.20 mm	22.85 mm	17.15 mm	EXH (12 pieces) Double Spring-7 deg Pro CNC Ferrea Racing Springs #S10056
AUDI RS6 4.2L - DOHC V8 40 VALVE (BCY) - 2002-2004					
E11031	6 mm	21 mm	-	15.15 mm	INT (24 pieces) Single Spring-7 deg Pro CNC Ferrea Racing Springs #S10055
E11032	6 mm	28.20 mm	22.85 mm	17.15 mm	EXH (16 pieces) Double Spring-7 deg Pro CNC Ferrea Racing Springs #S10056
AUDI 80 QUATRO 2.2 L - DOHC 20 VALVE (7A) - 1989-1992					
AUDI 200 QUATRO 2.2 L - DOHC 20 VALVE (3B) - 1991					
AUDI COUPE QUATRO 2.2 L - DOHC 20 VALVE (7A) - 1990-1991					
E11084	7 mm	28 mm	-	17.17 mm	Dble Spring-7 deg Pro CNC. 20 pieces Ferrea Racing Springs #S10115 and Ferrea Valve Lock # K10082
AUDI RS2 2.2 L - DOHC 20 VALVE (ADU) - 1994-1995					
AUDI S4 2.2 L - DOHC 20 VALVE (AAN) - 1992-1994					
AUDI S6 2.2 L - DOHC 20 VALVE (AAN) - 1995					
E11084	7 mm	28 mm	-	17.17 mm	Dble Spring-7 deg Pro CNC. 20 pieces Ferrea Racing Springs #S10115 and Ferrea Valve Lock # K10082

TITANIUM RETAINERS

Part#	Val. Stem Size	Diam.(A)	Out Step Diam.(B)	In Step Diam.(C)	References
AUDI V8 3.6 L - DOHC 32 VALVE (PT) - 1990-1991					
AUDI V8 4.2 L - DOHC 32 VALVE (ABH) - 1992-1994					
E11084	7 mm	28 mm	-	17.17 mm	Dble Spring-7 deg Pro CNC. 20 pieces Ferrea Racing Springs #S10115 and Ferrea Valve Lock # K10082
BMW E36 3.2L - DOHC 24 VALVE (S42 / M42 / M50/ S50 / M52 / M54) - 1990-2000					
E11025	6 mm	28.20 mm	-	17.17 mm	Double Spring-7 deg Pro CNC Ferrea Racing Springs #S10049
BMW E46 3.2L - DOHC 24 VALVE (S54) - 2001-2006					
E11128	6 mm	25.27mm	-	16.8 mm	Dble Spring-7deg Pro CNC-(16 pieces). Ferrea Racing Springs #S10156 Use Factory OE valve locks
BMW E60/E82/E91/E92 3.0L - DOHC 24 VALVE (N54) - 2007-2010					
E11130	6 mm	20.32mm	-	15.74mm	EXH Sgle Spring-7deg Pro CNC-(12 pieces). Ferrea Racing Springs #S10158 Use Factory OEM valve locks
E11131	5 mm	20.32mm	-	15.74mm	INT Sgle Spring-7deg Pro CNC-(12 pieces). Ferrea Racing Springs #S10158 Use Factory OEM valve locks
DODGE NEON 2.4 - SRT4 - DOHC 16 VALVE (A853) - 2003-2005					
E11073	6 mm	25.4 mm	-	16.51 mm	Dble Spring-6 deg Pro CNC Ferrea Racing Springs #S10107 and Ferrea Valve Lock #K10079
E11074	6 mm	25.4 mm	-	15.7 mm	Dble Spring-6 deg Pro CNC Ferrea Racing Springs #S10108 and Ferrea Valve Lock #K10079
FORD ESCORT 2.0L - DOHC ZETEC 16 VALVE (ZX2) - 1999-2001					
FORD FOCUS 2.0L - DOHC ZETEC 16 VALVE (ZX3) - 2000-2001					
E11018	5.5-6.01mm	24 mm	18.23 mm	10.79 mm	Single & Dble Spring-7 deg Pro CNC Ferrea Springs #S10040 and #S10041
Note: This Retainer (#E11018) can be used with either valve lock (5.5 and 6.01)					
FORD ECOBOOST 2.3L - DOHC 16 VALVE - 2015					
E11135	5.5mm	22.22mm	-	17.52mm	Sgle Spring-7° Pro CNC (16 pieces) Ferrea Racing Springs # S10163 Ferrea Valve Lock # K10113
GEO METRO/SUZUKI SWIFT 1.0 L - SOHC 6 VALVE (G10) - 1995-2001					
E11024	5.5 mm	24.23 mm	18.20 mm	12.92 mm	Dble Spring-7 deg Pro CNC Ferrea Racing Springs #S10047
GM 2.2 ECO TEC - 2000-2008					
E11033	6 mm	27.95 mm	20.8 mm	16.1 mm	Dble Spring-7 deg Pro CNC Ferrea Racing Springs #S10057
GM 5 CYLINDER - L5 - 2002-2006					
E11034	6 mm	27.95 mm	20.8 mm	16.1 mm	Dble Spring-7 deg Pro CNC Ferrea Racing Spring #S10058
HONDA ACCORD LX 2.4L - DOHC i-VTEC 16 VALVE (K24Z2) - 2008-2012					
HONDA CIVIC Si 2.4L - DOHC i-VTEC 16 VALVE (K24Z7) - 2012-2015					
E11141	5.5mm	27.10 mm	-	17.35 mm	Dble Spring-7 deg Pro CNC Ferrea Racing Springs #S10164 Ferrea Valve Lock #K10034
HONDA CIVIC 1.6L - SOHC 16 VALVE (D16Z6-Y5-Y7-Y8) - 1992-2000					
E11010	5.5 mm	21.60 mm	-	15.35 mm	Single Spring-7 deg Pro CNC Retainer. Ferrea Racing Spring # S10029
HONDA CIVIC TYPE-R 2.0L - DOHC VTEC 16 VALVE (K20C1-TURBO) - 2017-2018					
E11142	5.5mm	21.10mm	-	15.11mm	Sgle Spring-7deg Pro CNC Retainer. Ferrea Racing Spring # S10166 Ferrea Valve Lock # K10116
HONDA RETAINERS "7 DEG"					
E11000	5.5 mm	28.20 mm	22.85 mm	17.15 mm	Dble Spring-7deg Pro CNC Retainer. Ferrea Racing Spring # S10070 OR #S10104
E11000LW	5.5 mm	28.20 mm	22.85 mm	17.15 mm	Dble Spring-7deg Pro CNC Retainer. 7 grs Ferrea Racing Spring # S10070 OR #S10104
E11001	5.5 mm	28.10 mm	22.20 mm	15.77 mm	Dble Spring-7deg Pro CNC Retainer. Honda Stock Spring and Ferrea Valve Lock #K10034
E12020	5.5 mm	21.6 mm	-	14.73 mm	Beehive Spring. Pro CNC Retainer Ferrea Drag Racing Spring # S2014. Ferrea Valve Lock # K10034
HONDA S 2000 - F20C - 2000-2003					
HONDA S 2000 - F22C - 2004-2008					
E11045	5.5 mm	28.20 mm	22.85 mm	17.15 mm	Dble Spring-7 deg Pro CNC- Ferrea Racing Springs #S10074 and Ferrea Valve Lock #K10034
E12030	5.5 mm	21.6 mm	-	14.73 mm	Beehive Spring. Pro CNC Retainer Ferrea Racing Springs #S2022 and Ferrea Valve Lock #K10034

TITANIUM RETAINERS

Part#	Val. Stem Size	Diam.(A)	Out Step Diam.(B)	In Step Diam.(C)	References
HYUNDAI GENESIS 2.0L - DOHC 16 VALVE (TURBO BK) - 2008-2010					
E11089	5.5 mm	25.27 mm	-	16.76 mm	Dble Spring-7 deg Pro CNC - (16 pieces) Ferrea Racing Springs# S10118 and Ferrea Valve Lock # K10091
HYUNDAI GENESIS COUPE V-6 3.8L - DOHC 24 VALVE (LAMBDA) - 2010					
E11105	5.5 mm	24 mm	-	18.3 mm	Single Spring-7 deg Pro CNC- Ferrea Racing Springs #S10134 Ferrea Valve Lock # K10100
INFINITI V6 3.0L - DOHC 24 VALVE (VR30DDTT) - 2015-2018					
E12032	5.5 mm	22.86 mm	-	18.9 mm	Single Spring-7 deg Pro CNC- (24 pieces) Ferrea Racing Springs #S10169 Ferrea Valve Locks # K10119
LAMBORGHINI V10 5.0L - DOHC 40 VALVE - 2003-2007					
E11132	6.0 mm	20.32 mm	-	15.74 mm	Sggle Spring-7deg Pro CNC-(40 pieces) Ferrea Racing Springs #S10160 Use OEM Factory valve locks
LOTUS ELISE / EXIGE 1.8L - DOHC 16 VALVE (2ZZ-GE) - 2008					
E11097	5.5 mm	21.6 mm	-	13.97 mm	Double Spring-7 deg Pro CNC- (16 pieces) Ferrea Racing Springs #S10123 and Ferrea Valve Lock #K10094
MITSUBISHI 3000 GT 3.0L - DOHC 24 VALVE (6G72 - TURBO 6G72T) - 1990-2001					
E11053	6.5 mm	28.57 mm	-	17.35 mm	Dble Spring-6 deg Pro CNC- Ferrea Racing Springs #S10037 and Ferrea Valve Lock # K10035
MITSUBISHI ECLIPSE GS-GST 2.0L - DOHC 16 VALVE (4G63-4G63T) - 1990-1999					
E11005	6.5 mm	28.57 mm	-	17.35 mm	Dble Spring-6 deg Pro CNC- Ferrea Racing Springs #S10031 & #S10036 and Ferrea Valve Lock # K10035
E12021	6.5 mm	22.73 mm	-	14.60 mm	Beehive Spring - Pro CNC Retainer Ferrea Racing Spring # S2015. Ferrea Valve Lock #K10035
MITSUBISHI EVOLUTION VIII 2.0 L - DOHC 16 VALVE (TURBO 4G63T) - 2003-2007					
E11052	6.5 mm	28.57 mm	-	17.35 mm	Dble Spring-6 deg Pro CNC- Ferrea Racing Springs #S10084 and Ferrea Valve Lock # K10035
MITSUBISHI EVOLUTION X 2.0 L - DOHC 16 VALVE (4B11T) - 2007-2009					
E11089	5.5 mm	25.27 mm	-	16.76 mm	Dble Spring-7 deg Pro CNC- (16 pieces) Ferrea Racing Springs #S10118 and Ferrea Valve Lock # K10091
NISSAN 300 ZX 3.0L - DOHC 24 VALVE (VG30D-TURBO VG30DTT) - 1990-1996					
E11017	6.0 mm	25.4 mm	-	15.7 mm	Dble Spring-6 deg Pro CNC Retainer Ferrea Racing Spring # S10039
NISSAN 350 Z 3.5 L - V-6 - DOHC 24 VALVE (VQ35) - 2003-2008					
E11058	6 mm	24 mm	-	18.16 mm	Single Spring-6 deg Pro CNC- Ferrea Racing Springs #S10093 and Ferrea Valve Lock # K10069
E11060	5.5 mm	24 mm	18.3 mm	10.79 mm	Single Spring-7 deg Pro CNC- Ferrea Racing Springs #S10091 and Ferrea Valve Lock # K10071
E11079	6 mm	25.4 mm	-	15.75 mm	Dble Spring-6 deg Pro CNC Ferrea Racing Springs #S10103 and Ferrea Valve Lock # K10069
NISSAN ALTIMA 2.4L - DOHC 16 VALVE (KA24DE) - 1995-1999					
NISSAN 240 SX 2.4L - DOHC 16 VALVE (KA24DE) - 1991-1998					
E11021	7 mm	28.20 mm	22.85 mm	17.15 mm	Dble Spring-7 deg Pro CNC- (16 pieces). Ferrea Racing Springs #S10043 and Ferrea Valve Lock # K10062
NISSAN GT-R 3.8 L V-6 - DOHC 24 VALVE (VR38DETT) - 2009-2010					
E11106	5.5 mm	25.4 mm	-	15.75 mm	Dble Spring-7 deg Pro CNC- (24 pieces) Ferrea Racing Springs #S10136 Ferrea Valve Lock # K10102
E11107	5.5 mm	24.00 mm	18.16 mm	10.80 mm	INT (12 pieces) Single Spring-7 deg Pro CNC- Ferrea Racing Springs #S10137 Ferrea Valve Lock # K10102
E11110	5.5 mm	22.86 mm	-	18.9 mm	EXH (12 pieces) Single Spring-7 deg Pro CNC- Ferrea Racing Springs #S10137 Ferrea Valve Lock # K10102
NOTE: Profiles for Part # E11107 and # E11110 are different to provide the proper height installation.					
NISSAN PATROL 4.5L 6 CYL IN LINE - 12 VALVE - (TB45E) - 1997-2004					
E11102	8 mm	28.45 mm	23.1 mm	17.40 mm	Dble Spring-7 deg Pro CNC- (24 pieces) Ferrea Racing Springs #S10128

TITANIUM RETAINERS

Part#	Val. Stem Size	Diam.(A)	Out Step Diam.(B)	In Step Diam.(C)	References
NISSAN PATROL 4.8L 6 CYL IN LINE - 24 VALVE - (TB48DE) - 2004-2010					
E11083	6 mm	25.4 mm	-	16.51 mm	Dble Spring-6 deg Pro CNC- (24 pieces) Ferrea Racing Springs #S10114 and Ferrea Valve Lock # K10081
E11109	6 mm	26.67 mm	-	21.08 mm	Single Spring-6 deg Pro CNC (24 Pieces) Ferrea Racing Springs #S10131 and Ferrea Valve Lock # K10081
NISSAN SENTRA SE-R 2.0L - DOHC 16 VALVE (SR20DE-SR20DET) - 1991-1998					
E11002	6.0 mm	29.0 mm	-	17.15 mm	Dble Spring-6 degPro CNC Retainer. Nissan SR20 SE-R. Ferrea Racing Spring # S10038
NISSAN SKYLINE 6 CYL IN LINE - 24 VALVE - (RB25DET) - 1993-1997					
E11082	6 mm	25.4 mm	-	16.51 mm	Dble Spring-6 deg Pro CNC- (24 pieces) Ferrea Racing Springs #S10112 and Ferrea Valve Lock # K10063
NISSAN SKYLINE 6 CYL IN LINE - 24 VALVE - (RB26) - 1989-2002					
E11057	6 mm	26.67 mm	-	21 mm	Double Spring-6 deg Pro CNC- Ferrea Racing Springs #S10090 and Ferrea Valve Lock # K10072
NISSAN SKYLINE 6 CYL IN LINE - 24 VALVE (NEO) - 1998-2002					
E11048	6 mm	25.4 mm	-	16.51 mm	Double Spring-6 deg Pro CNC- (24 pieces) Ferrea Racing Springs #S10078 and Ferrea Valve Lock # K10063
NISSAN RETAINERS "6 DEG"					
E11002	6.0 mm	29.0 mm	-	17.15 mm	Dble Spring-6 degPro CNC Retainer. Nissan SR20 SE-R. Ferrea Racing Spring # S10038
PORSCHE 996TT 3.6L - FLAT 6 CYL - DOHC 24 VALVE - 2000-2005					
E11094	6.0 mm	25.4 mm	-	15.70 mm	Dble Spring-6 deg Pro CNC - (24 pieces) Ferrea Racing Springs# S10122 and Ferrea Valve Lock # K10092
NOTE: Ferrea Spring Retainers are designed to be used with Ferrea Valve Locks with single radial groove. For racing applications Ferrea Racing does not recommend the use of triple radial groove valves.					
SCION tC 2.4L - DOHC 16 VALVE (2AZFE) - 2005					
E11075	5.5 mm	24.1 mm	-	18.65 mm	Single spring-7 deg Pro CNC- Ferrea Racing Springs #S10110 and Ferrea Valve Lock #K10080
SCION tC 2.5L - DOHC 16 VALVE (2ARFE) - 2011					
E11117	5.5 mm	24 mm	18.3 mm	10.79 mm	Dble Spring-7 deg Pro CNC - (16 pieces) Ferrea Racing Springs #S10144 and Ferrea Valve Lock # K10080
E11118	5.5 mm	22.86 mm	-	18.9 mm	Single Spring-7 deg Pro CNC - (16 pieces) Ferrea Racing Springs #S10143 and Ferrea Valve Lock # K10080
SCION FR-S 2.0L - DOHC 16 VALVE (4U-GSE) - 2012-2015					
E11127	5.5 mm	25.27mm	-	16.89 mm	Dble Spring-7deg Pro CNC-(16 pieces). Ferrea Racing Springs #S10155 Use Factory OE valve locks
SUBARU WRX 2.0L - DOHC 16 VALVE (EJ20) - 2001-2008					
E11043	6 mm	25.40 mm	-	15.70 mm	Dble Spring-6 deg Pro CNC- Ferrea Racing Springs #S10071 and Ferrea Valve Lock # K10061
E11044	6 mm	25.40 mm	-	16.51 mm	Dble Spring-6 deg Pro CNC- Ferrea Racing Springs #S10072 and Ferrea Valve Lock # K10061
SUBARU WRX 2.0L - DOHC 16 VALVE (STI) - 2004-2008					
E11064	6 mm	25.40 mm	-	15.70 mm	Dble Spring-6 deg Pro CNC- Ferrea Racing Springs #S10097 and Ferrea Valve Lock # K10074
E11065	6 mm	25.40 mm	-	16.51 mm	Dble Spring-6 deg Pro CNC- Ferrea Racing Springs #S10098 and Ferrea Valve Lock # K10074
SUBARU BRZ 2.0L - DOHC 16 VALVE (FA20) - 2012-2015					
E11127	5.5 mm	25.27mm	-	16.89 mm	Dble Spring-7deg Pro CNC-(16 pieces). Ferrea Racing Springs #S10155 Use Factory OE valve locks
TOYOTA 4AG 1.6 L DOHC 16 VALVE (ATLANTIC) - 1983-1988					
E11046	6 mm	23 mm	-	16.38 mm	Single Spring-6 deg Pro CNC- Ferrea Racing Springs # S10080.
TOYOTA 1.8 L - DOHC 16 VALVE - (2ZZ-GE) - 2003-2006					
E11097	5.5 mm	21.6 mm	-	13.97 mm	Dble Spring-7 deg Pro CNC- (16 Pieces) Ferrea Racing Springs #S10123. Ferrea Valve Lock # K10094

TITANIUM RETAINERS

Part#	Val. Stem Size	Diam.(A)	Out Step Diam.(B)	In Step Diam.(C)	References
TOYOTA MR2 2.0L - DOHC 16 VALVE (TURBO 3SGTE) - 1990-1995					
E11011	6.0 mm	25.4 mm	-	16.51 mm	Dble Spring-6 deg Pro CNC Retainer. (16 Pieces) Ferrea Racing Spring # S10034
TOYOTA MR2 2.0L - DOHC 16 VALVE (3SGTE GEN 3) - 1996-1998					
E11123	6mm	25.4mm	20.95mm	16.51mm	Dble Spring-6 deg Pro CNC. (16 pieces). Ferrea Racing Springs #S10151 Ferrea Valve Lock #K10108
TOYOTA 2.0 L - DOHC 16 VALVE (3SGE)					
E11042	5.5 mm	25.85 mm	-	15.88 mm	Dble Spring-7 deg Pro CNC. (16 Pieces) Ferrea Racing Springs #S10073 Ferrea Valve Lock #K10107
TOYOTA FJ CRUISER V6 4L - DOHC 24 VALVE (1GR-FE) - 2006-2008					
E11100	5.5 mm		-	16.51 mm	Dble Spring-7 deg Pro CNC- (24 Pieces) Ferrea Racing Springs #S10127. Ferrea Valve Lock #K10097
E11104	5.5 mm	23.5 mm	-	18.8 mm	Single Spring-7 deg Pro CNC- (24 Pieces) Ferrea Racing Springs #S10132. Ferrea Valve Lock #K10097
TOYOTA LANDCRUISER 4.5L - DOHC 24 VALVE (1FZFE) - 1993-1997					
E11096	7 mm	25.27 mm	-	16.71 mm	Dble Spring-7 deg Pro CNC- (24 Pieces) Ferrea Racing Springs #S10126. Ferrea Valve Lock # K10096
TOYOTA SUPRA 3.0L - DOHC 24 VALVE (7MGE-TURBO 7MGTE) - 1986-1992					
E11095	6 mm	24.25 mm	19.05 mm	13.97 mm	Dble Spring-6 deg Pro CNC- (24 Pieces) Ferrea Racing Spring #S10120
TOYOTA SUPRA 3.0 I/L 6 CYL - DOHC 24 VALVE (2JZGE-2JZGTE) - 1994-1998					
E11145	6.0 mm	25 mm	-	15 mm	Dble Spring-6 deg Pro CNC Retainer. (24 Pieces) Ferrea Springs # S10178 and S10179 Ferrea Valve Lock # K10037
E12029	6 mm	22.73 mm	-	14.60 mm	Beehive Spring. Pro CNC Retainer. (24 Pieces) Ferrea Racing Spring #S2021. Ferrea Valve Lock #K10037
TOYOTA SUPRA 3.0L - DOHC 24 VALVE (B58) TURBO - 2019					
E11146	6.0 mm	20 mm	-	15.6 mm	EXH (12 pieces) Sgle Spring-7deg Pro CNC Ferrea Springs # S10177
E11147	5.0 mm	20 mm	-	15.6 mm	INT (12 pieces) Sgle Spring-7deg Pro CNC Ferrea Springs # S10177
TOYOTA GT86 2.0L - DOHC 16 VALVE (4U-GSE) EUROPE - 2012-2015					
E11127	5.5 mm	25.27mm	-	16.89 mm	Dble Spring-7deg Pro CNC-(16 pieces). Ferrea Racing Springs #S10155 Use Factory OE valve locks
VW 1.8T - DOHC 20 VALVE - 1998-2005					
E11031	6 mm	21 mm	-	15.15 mm	INT (12 pieces)Single Spring-7 deg Pro CNC Ferrea Racing Spring # S10120
E11032	6 mm	28.20 mm	22.85 mm	17.15 mm	EXH (8 pieces)Dble Spring-7 deg Pro CNC Ferrea Racing Spring # S10056
VW 2.0T FSI - DOHC 16 VALVE - 2006-2008					
E11129	6 mm	20.32mm	-	15.74mm	Sgle Spring-7deg Pro CNC-(16 pieces). Ferrea Racing Springs #S10157 Use Factory OEM valve locks
VW 2.0T TSI - DOHC 16 VALVE - 2009-2013					
VW GOLF R 2.0T TSI - DOHC 16 VALVE - 2015-2016					
E11129	6 mm	20.32mm	-	15.74mm	Sgle Spring-7deg Pro CNC-(16 pieces). Ferrea Racing Springs #S10157 Use Factory OEM valve locks
E11139	6 mm	20.32 mm	-	15.75 mm	INT (8 pieces) Sgle Spring-7deg Pro CNC Ferrea Racing Springs #S10157 Use Factory OEM valve locks
E11140	6 mm	20.32 mm	-	15.75 mm	EXH (8 pieces) Sgle Spring-7deg Pro CNC Ferrea Racing Springs #S10157 Use Factory OEM valve locks
VW GOLF / JETTA 1.8 L - DOHC 16 VALVE (PL) - 1987-1989					
VW SCIROCCO 1.8 L - DOHC 16 VALVE (PL) - 1986-1988					
E11084	7 mm	28 mm	-	17.17 mm	Dble Spring-7 deg Pro CNC- 16 pieces Ferrea Racing Springs #S10115. Ferrea Valve Lock #K10082
VW GOLF / JETTA 2.0 L - DOHC 16 VALVE (9A) - 1990-1992					
VW PASSAT 2.0 L - DOHC 16 VALVE (9A) - 1990-1994					
E11084	7 mm	28 mm	-	17.17 mm	Dble Spring-7 deg Pro CNC- 16 pieces Ferrea Racing Springs #S10115. Ferrea Valve Lock #K10082
VW BEETLE/GOLF/JETTA/RABBIT 2.5L - DOHC 20 VALVE (BTW) - 2005 1/2 - 2009					
E11134	6mm	20.32mm	-	15.74mm	Sgle Spring-7 deg Pro CNC (20 pieces) Ferrea Racing Spring # S10162 Use Factory OEM valve locks

TITANIUM RETAINERS

Part#	Val. Stem Size	Diam.(A)	Out Step Diam.(B)	In Step Diam.(C)	References
VW VR6 2.8L - DOHC 12 VALVE - 1992-2002					
E11039	7 mm	28 mm	-	17.17 mm	Dble Spring-7 deg Pro CNC- Ferrea Racing Springs #S10062. Ferrea Valve Lock #K10099
VW VR6 2.8L - DOHC 24 VALVE (BDF) - 2002-2004					
E11063	6 mm	20.57 mm	-	15.5 mm	Single Spring-7 deg Pro CNC- Ferrea Racing Springs #S10087 This retainer has to be used with OEM valve lock
VW VR6 R32 3.2L - DOHC 24 VALVE 2004-2011					
E11122	6mm	24mm	18.3mm	10.79mm	Dble Spring-7deg Pro CNC-(24 pieces). Ferrea Racing Springs #S10148 Use Factory OE valve locks

TOOL STEEL RETAINERS

Part#	Val. Stem Size	Diam.(A)	Out Step Diam.(B)	In Step Diam.(C)	References
ACURA RSX 2.0L - DOHC VTEC 16 VALVE (K20) - 2001-2006					
E20044	5.5 mm	28.19 mm	-	17.15 mm	Dble Spring-7 deg Pro CNC - (16 pieces) Ferrea Racing Springs# S10099 or #S10100 Ferrea Valve Lock # K10034
E20054	5.5mm	27.94mm	-	17mm	Dble Spring-7deg Pro CNC-(16 pieces). Ferrea Racing Springs #S10149 Ferrea Valve Lock #K10034
AUDI 2.0T FSI - DOHC 16 VALVE - 2006-2008					
E20043	6 mm	22.10 mm	-	16.13 mm	Dble Spring-7 deg Pro CNC - (16 pieces) Ferrea Racing Springs# S10121
HONDA CIVIC TYPE-R 2.0L - DOHC VTEC 16 VALVE (K20C1-TURBO) - 2017-2018					
E20056	5.5mm	21.10mm	-	16mm	Sgle Spring-7deg Pro CNC Retainer. Ferrea Racing Spring # S10165 Ferrea Valve Lock # K10116
HONDA RETAINERS "7 DEG"					
E20037	5.5 mm	26.92 mm	23.37 mm	-	Dble Spring-7 deg Pro CNC - (16 pieces) Ferrea Racing Springs# S10104 and Ferrea Valve Lock # K10034
E20041	5.5 mm	28.19 mm	22.86 mm	-	Dble Spring-7 deg Pro CNC - (16 pieces) Ferrea Racing Springs# S10027 or S10070 Ferrea Valve Lock # K10034
HYUNDAI GENESIS 2.0L - DOHC 16 VALVE (TURBO BK) - 2008-2010					
E20046	5.5 mm	25.15 mm	-	16.76 mm	Dble Spring-7 deg Pro CNC - (16 pieces) Ferrea Racing Springs# S10118 Ferrea Valve Lock # K10091
MITSUBISHI EVOLUTION VIII 2.0L - DOHC 16 VALVE (TURBO 4G63T) - 2003-2007					
E20045	6.5 mm	28.19 mm	-	17.35 mm	Dble Spring-6 deg Pro CNC - (16 pieces) Ferrea Racing Springs# S10084 Ferrea Valve Lock # K10035
MITSUBISHI EVOLUTION X 2.0L - DOHC 16 VALVE (4B11T) - 2007-2009					
E20046	5.5 mm	25.15 mm	-	16.76 mm	Dble Spring-7 deg Pro CNC - (16 pieces) Ferrea Racing Springs# S10118 Ferrea Valve Lock # K10091
SCION FR-S 2.0L - DOHC 16 VALVE (4U-GSE) - 2012-2013					
E20055	5.5mm	27.94mm	-	20.95mm	Sgle Spring-7deg Pro CNC-(16 pieces). Ferrea Racing Springs #S10154 Use Factory OE valve locks
SUBARU WRX 2.0L - DOHC 16 VALVE (EJ20) - 2001-2008					
E20047	6 mm	25.27 mm	-	16.51 mm	Dble Spring-6 deg Pro CNC - (16 pieces) Ferrea Racing Springs# S10071 Ferrea Valve Lock # K10061
E20048	6 mm	25.27 mm	-	15.70 mm	Dble Spring-6 deg Pro CNC - (16 pieces) Ferrea Racing Springs# S10072 Ferrea Valve Lock # K10061
SUBARU BRZ 2.0L - DOHC 16 VALVE (FA20) - 2012-2013					
E20055	5.5mm	27.94mm	-	20.95mm	Sgle Spring-7deg Pro CNC-(16 pieces). Ferrea Racing Springs #S10154 Use Factory OE valve locks
TOYOTA 4AGELU 1.6L - DOHC 20 VALVE - 1995-1998					
E20052	6mm	18.80mm	-	14.35mm	Sgle Spring-7deg Pro CNC-(20 pieces). Ferrea Racing Springs #S10150 Ferrea Valve Lock #K10106
TOYOTA GT86 2.0L - DOHC 16 VALVE (4U-GSE) EUROPE - 2012-2013					
E20055	5.5mm	27.94mm	-	20.95mm	Sgle Spring-7deg Pro CNC-(16 pieces). Ferrea Racing Springs #S10154 Use Factory OE valve locks

STEEL VALVE LOCKS

Part# Specifications

VALVE LOCKS "6 DEG."

K10111 6 mm Radial Groove - Top Lock

ACURA RADIAL VALVE LOCKS "7 DEG."

HONDA RADIAL VALVE LOCKS "7 DEG."

K10034 5.5 mm. Radial Groove.

AUDI 80 QUATRO 2.2 L - DOHC 20 VALVE (7A) - 1989-1992

AUDI 200 QUATRO 2.2 L - DOHC 20 VALVE (3B) - 1991

AUDI COUPE QUATRO 2.2 L - DOHC 20 VALVE (7A) - 1990-1991

K10082 7 mm. Radial Groove. Use with Ferrea Titanium Retainer # E11084

AUDI RS 2.2 L - DOHC 20 VALVE (ADU) - 1994-1995

AUDI S4 2.2 L - DOHC 20 VALVE (AAN) - 1992-1994

AUDI S6 2.2 L - DOHC 20 VALVE (AAN) - 1995

K10082 7 mm. Radial Groove. Use with Ferrea Titanium Retainer # E11084

AUDI V8 3.6 L - DOHC 32 VALVE (PT) - 1990-1991

AUDI V8 4.2 L - DOHC 32 VALVE (ABH) - 1992-1994

K10082 7 mm. Radial Groove. Use with Ferrea Titanium Retainer # E11084

DODGE NEON 2.4 - SRT4 - DOHC 16 VALVE (A853) - 2003-2005

K10079 6 mm. Radial Groove. Use with Ferrea Titanium Retainer # E11073 or #E11074

FORD ESCORT 2.0L - DOHC ZETEC 16 VALVE (ZX2) - 1999-2001

FORD FOCUS 2.0L - DOHC ZETEC 16 VALVE (ZX3) - 2000-2001

K10052 5.5 mm. Radial Groove

FORD ECOBOOST 2.3L - DOHC 16 VALVE - 2015

K10113 5.5mm. Radial Groove

HONDA CIVIC TYPE-R 2.0L - DOHC VTEC 16 VALVE (K20C1-TURBO) - 2017-2018

K10116 5.5 mm. Radial Groove. Use with Ferrea Titanium Retainer #E11142 or Ferrea Tool Steel Retainer #E20056

INFINITI V6 3.0L - DOHC 24 VALVE (VR30DDTT) - 2015-2018

K10119 5.5mm. Radial Groove. Use with Ferrea Titanium Retainer # E12032

LOTUS ELISE / EXIGE 1.8L - DOHC 16 VALVE (2ZZ-GE) - 2008

K10094 5.5 mm. Radial Groove.

MITSUBISHI 3000 GT 3.0L - DOHC 24 VALVE (6G72 - TURBO 6G72T) - 1990-2001

K10035 6.5 mm. Radial Groove. Use with Ferrea Titanium Retainer # E11053

MITSUBISHI ECLIPSE GS-GST 2.0L - DOHC 16 VALVE (4G63-4G63T) - 1990-1999

K10035 6.5 mm. Radial Groove. Use with Ferrea Titanium Retainer # E11005

MITSUBISHI EVOLUTION VIII 2.0L - DOHC 16 VALVE (TURBO 4G63T) - 2003-2007

K10035 6.5 mm. Radial Groove. Use with Ferrea Titanium Retainer # E11052

MITSUBISHI EVOLUTION X 2.0L - DOHC 16 VALVE (4B11T) - 2007-2009

K10091 5.5 mm. Radial Groove. Use with Ferrea Titanium Retainer # E11089

NISSAN 350 Z 3.5 L - V-6 - DOHC 24 VALVE (VQ35) - 2003-2008

K10071 5.5 mm. Radial Groove. Use with Ferrea Titanium Retainer # E11060

K10069 6 mm. Radial Groove. Use with Ferrea Titanium Retainer # E11058 and #E11079

NISSAN ALTIMA 2.4L - DOHC 16 VALVE (KA24DE) - 1995-1999

NISSAN 240 SX 2.4L - DOHC 16 VALVE (KA24DE) - 1991-1998

K10062 7 mm. Radial Groove. Use with Ferrea Titanium Retainer # E11021

NISSAN GT-R 3.8 L V-6 - DOHC 24 VALVE (VR38DETT) - 2009-2010

K10102 5.5 mm. Radial Groove. Use with Ferrea Titanium Retainer # E11106, #E11107 and # E11110

NISSAN PATROL 4.8L 6 CYL IN LINE - 24 VALVE - (TB48DE) - 2004-2010

K10081 6 mm. Radial Groove. Use with Ferrea Titanium Retainer # E11083 and #E11109

NISSAN SKYLINE 6 CYL IN LINE - 24 VALVE - (RB25DET) - 1993-1997

K10063 6 mm. Radial Groove. Use with Ferrea Titanium Retainer # E11082

NISSAN SKYLINE 6 CYL IN LINE - 24 VALVE - (RB26) - 1989-2002

K10072 6 mm. Radial Groove. Use with Ferrea Titanium Retainer # E11057

NISSAN SKYLINE 6 CYL IN LINE - 24 VALVE - (NEO) - 1998-2002

K10063 6 mm. Radial Groove. Use with Ferrea Titanium Retainer # E11048

NISSAN RADIAL VALVE LOCKS "6 DEG."

K10036 6 mm. Radial Groove.

PORSCHE 996TT 3.6L - FLAT 6 CYL - DOHC 24 VALVE - 2000-2005

K10092 6 mm. Radial Groove. Use with Ferrea Titanium Retainer # E11094

STEEL VALVE LOCKS

Part#	Specifications
SCION tC 2.4L - DOHC 16 VALVE (2AZFE) - 2005	
K10080	5.5 mm. Radial Groove. Use with Ferrea Titanium Retainer # E11075
SUBARU WRX 2.0L - DOHC 16 VALVE (EJ20) - 2001-2008	
K10061	6 mm. Radial Groove
SUBARU WRX 2.0L - DOHC 16 VALVE (STI) - 2004-2008	
K10074	6 mm. Radial Groove. Use with Ferrea Titanium Retainer #E11064 or E11065.
TOYOTA 4AGELU 1.6L - DOHC 20 VALVE - 1995-1998	
K10106	5 mm. Radial Groove. Use with Ferrea Titanium Retainer # E20052
TOYOTA RADIAL VALVE LOCKS "6 DEG."	
K10037	6 mm. Radial Groove.
TOYOTA 1.8L - DOHC 16 VALVE (2ZZ-GE) - 2003-2006	
K10094	5.5 mm. Radial Groove.
TOYOTA MR2 2.0L - DOHC 16 VALVE (3SGTE GEN 3) - 1996-1998	
K10108	6 mm. Radial Groove. Use with Ferrea Titanium Retainer # E11123
TOYOTA 2.0L - DOHC 16 VALVE (3SGE)	
K10107	5.5 mm. Radial Groove. Use with Ferrea Titanium Retainer # E11042
TOYOTA FJ CRUISER V6 4L - DOHC 24 VALVE (1GR-FE) - 2006-2008	
K10097	5.5 mm. Radial Groove.
TOYOTA LANDCRUISER 4/5L - DOHC 24 VALVE (1FZFE) - 1993-1997	
K10096	7 mm. Radial Groove.
VW GOLF / JETTA 1.8 L - DOHC 16 VALVE (PL) - 1987-1989	
VW SCIROCCO 1.8 L - DOHC 16 VALVE (PL) - 1986-1988	
K10082	7 mm. Radial Groove. Use with Ferrea Titanium Retainer # E11084
VW GOLF / JETTA 2.0 L - DOHC 16 VALVE (9A) - 1990-1992	
VW PASSAT 2.0 L - DOHC 16 VALVE (9A) - 1990-1994	
K10082	7 mm. Radial Groove. Use with Ferrea Titanium Retainer # E11084
VW VR6 2.8L - DOHC 12 VALVE - 1992-2002	
K10099	7 mm. Radial Groove. Use with both Ferrea Titanium Retainer # E11039 and OEM steel retainers.

SPRING SEAT LOCATORS

Part#	Specifications
ACURA INTEGRA GSR 1.7L - DOHC VTEC 16 VALVE (B17A1) - 1992-1993	
ACURA INTEGRA GSR 1.8L - DOHC VTEC 16 VALVE (B18C1-C3) - 1994-2000	
SL1000	Required for Ferrea Springs # S10027 and S10104
SL1004	Required for Ferrea Springs # S10027 and S10070
	This Seat Locator is designed with a step for HIGH PRESSURE.
SL1044	Required for Ferrea Spring # S10086. This Seat Locator is designed for HIGH PRESSURE
SL1090	Required for Ferrea Behive Spring # S2014
ACURA INTEGRA LS-GS 1.8L - DOHC VTEC 16 VALVE (B18A1-B1) - 1990-2000	
HONDA CRV 2.0L - DOHC VTEC 16 VALVE (B20A-B20Z)-1997-2000	
SL1017	Required for Ferrea Spring # S10046 (8 pieces-FOR EXHAUST APPLICATION ONLY) FOR INTAKE APPLICATION use Factory supplied Spring Seat Locator
ACURA RSX 2.0L - DOHC VTEC 16 VALVE (K20) - 2001-2006	
SL1052	Required for Ferrea Spring # S10099 (16 Pieces)
SL1053	Required for Ferrea Spring # S10100 (16 Pieces)
SL1094	Required for Ferrea Spring # S2018 (16 Pieces)
SL1136	Required for Ferrea Springs #S10149 (16 Pieces)
ACURA TSX 2.4L - DOHC i-VTEC 16 VALVE (K24Z3) - 2009-2014	
ACURA ILX 2.4L - DOHC i-VTEC 16 VALVE (K24Z7) - 2013-2015	
SL1149	Required for Ferrea Spring # S10164 (16 Pieces)
AUDI 1.8T - DOHC 20 VALVE - 1996-2005	
SL1025	Intake (12 Pieces)
SL1026	Exhaust (8 Pieces)

SPORT COMPACT APPLICATIONS

SPRING SEAT LOCATORS

Part#	Specifications
AUDI 2.0T FSI - DOHC 16 VALVE - 2006-2008	
AUDI 2.0T TFSI - DOHC 16 VALVE - 2009-2013	
SL1142	Required for Ferrea Springs #S10157 (16 Pieces)
AUDI TTRS / RS3 2.5L TFSI - DOHC 20 VALVE (DAZA) TURBO - 2017-2018	
SL1162	Intake (10 pieces). Required for Ferrea Spring # S10170
SL1163	Exhaust (10 pieces). Required for Ferrea Spring # S10170
AUDI 2.7T - DOHC 30 VALVE (APB) - 1998-2004	
SL1025	Intake (18 pieces)
SL1026	Exhaust (12 pieces)
AUDI RS6 4.2I - DOHC V8 40 VALVE (BCY) - 2002-2004	
SL1025	Intake (24 pieces)
SL1026	Exhaust (16 pieces)
AUDI 80 QUATRO 2.2 L - DOHC 20 VALVE (7A) - 1989-1992	
AUDI 200 QUATRO 2.2 L - DOHC 20 VALVE (3B) - 1991	
AUDI COUPE QUATRO 2.2 L - DOHC 20 VALVE (7A) - 1990-1991	
SL1073	Required for Ferrea Spring # S10115 (20 pieces)
AUDI RS2 2.2 L - DOHC 20 VALVE (ADU) - 1994-1995	
AUDI S4 2.2 L - DOHC 20 VALVE (AAN) - 1992-1994	
AUDI S6 2.2 L - DOHC 20 VALVE (AAN) - 1995	
SL1073	Required for Ferrea Spring # S10115 (20 pieces)
AUDI V8 3.6 L - DOHC 32 VALVE (PT) - 1990-1991	
AUDI V8 4.2 L - DOHC 32 VALVE (ABH) - 1992-1994	
SL1073	Required for Ferrea Spring # S10115 (20 pieces)
BMW E36 3.2L - DOHC 24 VALVE (S42 / M42 / M50/ S50 / M52 / M54) - 1990-2000	
SL1021	Required for Ferrea Spring # S10049 (24 pieces)
SL1045	Required for Ferrea Spring # S10049. Seat Locator is designed with a step for HIGH PRESSURE. (24 pieces)
BMW E46 3.2L - DOHC 24 VALVE (S54) - 2001-2006	
SL1141	Required for Ferrea Springs #S10156 (24 Pieces)
DODGE NEON 2.4 - SRT4 -DOHC 16 VALVE (A853) - 2003-2005	
SL1061	Required for Ferrea Spring # S10107 (16 pieces). Use BOTH Ferrea Spring Seat Locator #SL1061 and Factory supplied Spring Seat Locator
SL1062	Required for Ferrea Spring # S10108 (16 pieces). Use BOTH Ferrea Spring Seat Locator #SL1062 and Factory supplied Spring Seat Locator
FORD ESCORT 2.0L - DOHC ZETEC 16 VALVE (ZX2) - 1999-2001	
FORD FOCUS 2.0L - DOHC ZETEC 16 VALVE (ZX3) - 2000-2001	
SL1014	Required for Ferrea Spring # S10040 (16 pieces). Use BOTH, Ferrea Spring Seat Locator #SL1014 and Factory supplied Spring Seat Locator
SL1015	Required for Ferrea Spring # S10041 (16 pieces)
FORD ECOBOOST 2.3L - DOHC 16 VALVE - 2015	
SL1147	Required for Ferrea Springs # S10163. Seat Locator and Valve Seal one piece assembly
GEO METRO/SUZUKI SWIFT 1.0 L - SOHC 6 VALVE (G10) - 1995-2001	
SL1018	Required for Ferrea Spring # S10047 (6 pieces).
GM 2.2 ECO TEC - 2000-2008	
SL1028	Required for Ferrea Spring # S10057 (16 pieces) This Seat Locator is designed with a step for HIGH PRESSURE.
GM 5 CYLINDER - L5 - 2002-2006	
SL1027	Required for Ferrea Spring # S10058 (20 pieces). Use BOTH, Ferrea Spring Seat Locator #SL1027 and Factory supplied Spring Seat Locator
HONDA ACCORD LX 2.4L - DOHC i-VTEC 16 VALVE (K24Z2) - 2008-2012	
HONDA CIVIC Si 2.4L - DOHC i-VTEC 16 VALVE (K24Z7) - 2012-2015	
SL1149	Required for Ferrea Spring # S10164 (16 Pieces)
HONDA DEL SOL 1.6L - DOHC VTEC 16 VALVE (B16A1) - 1994-1997	
HONDA CIVIC SI 1.6L - DOHC VTEC 16 VALVE (B16A3) - 1999-2000	
SL1000	Required for Ferrea Springs # S10104
SL1003	Required for Ferrea Springs # S10027 (16 Pieces)
SL1004	Required for Ferrea Springs # S10027 and S10070 This Seat Locator is designed with a step for HIGH PRESSURE.
SL1044	Required for Ferrea Spring# S10086. This Seat Locator is designed for HIGH PRESSURE
SL1090	Required for Ferrea Behive Spring# S2014
HONDA CIVIC TYPE-R 2.0L - DOHC VTEC 16 VALVE (K20C1-TURBO) - 2017-2018	
SL1151	INTAKE Required for Ferrea Spring # S10165 (8 Pieces)
SL1152	EXHAUST Required for Ferrea Spring # S10165 (8 Pieces)
SL1153	INTAKE Required for Ferrea Spring # S10166 (8 Pieces)
SL1154	EXHAUST Required for Ferrea Spring # S10166 (8 Pieces)
HONDA PRELUDE 2.2L - DOHC VTEC 16 VALVE (H22A1-A4) - 1993-2000	
SL1003	Required for Ferrea Springs # S10027, S10104 and S10070
SL1090	Required for Ferrea Beehive Spring# S2014

SPRING SEAT LOCATORS

Part# Specifications

HONDA S 2000 - F20C - 2000-2003

HONDA S 2000 - F22C - 2004-2008

- SL1035 Required for Ferrea Springs # S10074 (16 pieces)
- SL1119 Required for Ferrea Springs # S2022 (INTAKE 8 pieces)
- SL1120 Required for Ferrea Springs # S2022 (EXHAUST 8 pieces)
- SL1121 Required for Ferrea Springs # S2022 (EXHAUST 8 pieces)

HYUNDAI GENESIS 2.0L - DOHC 16 VALVE (TURBO BK) - 2008-2010

- SL1096 Required for Ferrea Springs # S10118 (16 pieces). Use BOTH, Ferrea Spring Seat Locator # SL1096 and Factory supplied Spring Seat Locator

INFINITI V6 3.0L - DOHC 24 VALVE (VR30DDTT) - 2015-2018

- SL1161 Required for Ferrea Springs # S10169 (24 Pieces)

LAMBORGHINI V10 5.0L - DOHC 40 VALVE - 2003-2007

- SL1143 Required for Ferrea Springs # S10160 (40 pieces)

LOTUS ELISE / EXIGE 1.8L - DOHC 16 VALVE (2ZZ-GE) - 2008

- SL1105 Required for Ferrea Spring # S10123 (16 pieces)

MITSUBISHI 3000 GT 3.0L - DOHC 24 VALVES (6G72-TURBO 6G72T) - 1990-2001

- SL1008 Required for Ferrea Spring # S10037 (24 pieces)

MITSUBISHI ECLIPSE GS-GST 2.0L - DOHC 16 VALVE (4G63-4G63T) - 1990-1999

- SL1002 Required for Ferrea Spring # S10031 (16 pieces)
- SL1009 Required for Ferrea Spring # S10036 (16 pieces)
- SL1091 Required for Ferrea Beehive Spring # S2015 (16 pieces)

MITSUBISHI EVOLUTION VIII 2.0L - DOHC 16 VALVE (TURBO 4G63T) - 2003-2007

- SL1041 Required for Ferrea Spring # S10084 (16 pieces).

MITSUBISHI EVOLUTION X 2.0L - DOHC 16 VALVE (4B11T) - 2007-2009

- SL1096 Required for Ferrea Springs # S10118 (16 pieces). Use BOTH, Ferrea Spring Seat Locator # SL1096 and Factory supplied Spring Seat Locator

NISSAN 300 ZX 3.0L - DOHC 24 VALVE (VG30D-TURBO VG30DDT) - 1990-1996

- SL1012 Required for Ferrea Spring # S10039 (24 pieces)

NISSAN 350 Z 3.5 L - V-6 - DOHC 24 VALVE (VQ35) - 2003-2008

- SL1048 Required for Ferrea Spring # S10091 (24 pieces).
- SL1065 Required for Ferrea Spring # S10103 (24 pieces).

NISSAN ALTIMA 2.4L - DOHC 16 VALVE (KA24DE) 1995-1998

NISSAN 240 SX 2.4L - DOHC 16 VALVE (KA24DE) 1991-1998

- SL1064 Required for Ferrea Spring #10043 (16 pieces) Use BOTH Ferrea Spring Seat Locator #SL1064 and Factory supplied Spring Seat Locator.

NISSAN GT-R 3.8 L V-6 - DOHC 24 VALVE (VR38DETT) - 2009-2010

- SL1115 Intake. Required for Ferrea Spring # S10136 (24 pieces)
- SL1116 Required for Ferrea Spring # S10137 (24 pieces)
- SL1118 Exhaust. Required for Ferrea Spring # S10136 (24 pieces)

NISSAN PATROL 4.5L 6 CYL IN LINE - 12 VALVE - (TB45E) - 1997-2004

- SL1111 Required for Ferrea Spring #10128 (24 pieces)

NISSAN PATROL 4.8L 6 CYL IN LINE - 24 VALVE - (TB48DE) - 2004-2010

- SL1070 Required for Ferrea Spring #10114 (24 pieces)

NISSAN SENTRA SE-R 2.0L - DOHC 16 VALVE (SR20DE-SR20DET) - 1991- 1998

- SL1011 Required for Ferrea Spring # S10038 (16 pieces)

NISSAN SKYLINE 6 CYL IN LINE - 24 VALVE - (RB26) - 1989-2002

- SL1047 Required for Ferrea Spring # S10090 (24 pieces).

NISSAN SKYLINE 6 CYL IN LINE - 24 VALVE - (RB25DET) - 1993-1997

- SL1068 Exhaust. Required for Ferrea Spring # S10112 (24 pieces)
- SL1069 Intake. Required for Ferrea Spring # S10112 (12 pieces)

NISSAN SKYLINE 6 CYL IN LINE - 24 VALVE (NEO) - 1998-2002

- SL1037 INTAKE Required for Ferrea Springs # S10078 (12 pieces). Use BOTH, Ferrea Spring Seat Locator # SL1037 and Factory supplied Spring Seat Locator.
- SL1150 EXHAUST Required for Ferrea Spring # S10078 (12 Pieces).

PORSCHE 996TT 3.6L - FLAT 6 CYL - DOHC 24 VALVE - 2000-2005

- SL1099 Required for Ferrea Spring # S10122 (24 pieces)

SCION tC 2.4L - DOHC 16 VALVE (2AZFE) - 2005

- SL1063 Required for Ferrea Spring #S10110 (16 pieces).

SPRING SEAT LOCATORS

Part#	Specifications
SCION tC 2.5L - DOHC 16 VALVE (2ARFE) - 2011	
SL1126	Required for Ferrea Springs # S10143 (16 pieces) and S10144 (16 pieces)
SCION FR-S 2.0L - DOHC 16 VALVE (4U-GSE) - 2012-2015	
SL1139	Required for Ferrea Springs #S10154 (16 Pieces)
SL1140	Required for Ferrea Springs #S10155 (16 Pieces)
SUBARU WRX 2.0L - DOHC 16 VALVE (EJ20) - 2001-2008	
SL1034	Required for Ferrea Springs # S10071 (16 pieces) and #S10072 (16 pieces)
SUBARU WRX 2.0L - DOHC 16 VALVE (STI) - 2004-2008	
SL1051	Required for Ferrea Springs # S10097 (16 pieces) and #S10098 (16 pieces)
SUBARU BRZ 2.0L - DOHC 16 VALVE (FA20) - 2012-2015	
SL1139	Required for Ferrea Springs #S10154 (16 Pieces)
SL1140	Required for Ferrea Springs #S10155 (16 Pieces)
TOYOTA 4AGELU 1.6L - DOHC 20 VALVE - 1995-1998	
SL1133	Required for Ferrea Springs #S10150 (20 Pieces)
TOYOTA 1.8L - DOHC 16 VALVE (2ZZ-GE) - 2003-2006	
SL1105	Required for Ferrea Spring # S10123 (16 pieces)
TOYOTA MR2 2.0L - DOHC 16 VALVE (TURBO 3SGTE) - 1990-1995	
SL1007	Required for Ferrea Spring # S10034 (16 pieces)
TOYOTA MR2 2.0L - DOHC 16 VALVE (3SGTE GEN 3) - 1996-1998	
SL1134	Required for Ferrea Springs #S10151 (16 Pieces)
TOYOTA FJ CRUISER V6 4.0L - DOHC 24 VALVE (1GR-FE) - 2006-2008	
SL1110	Required for Ferrea Spring # S10127 (24 pieces)
TOYOTA LANDCRUISER 4.5L - DOHC 24 VALVE (1FZFE) - 1993-1997	
SL1109	Required for Ferrea Spring # S10126 (24 pieces)
SL1114	Required for Ferrea Spring # S10131 (24 pieces)
TOYOTA SUPRA 3.0L I/L 6 CYL - DOHC 24 VALVE (2JZGE-2JZGTE) - 1994-1998	
SL1173	Required for Ferrea Spring # S10178 (24 pieces)
SL1174	Required for Ferrea Spring # S10179 (24 pieces)
TOYOTA SUPRA 3.0L - DOHC 24 VALVE (B58) TURBO - 2019	
SL1175	Exhaust (12 pieces). Required for Ferrea Spring # S10177. Seat Locator and Viton Valve Seal one piece assembly
SL1176	Intake (12 pieces). Required for Ferrea Spring # S10177. Seat Locator and Viton Valve Seal one piece assembly
TOYOTA 2.0 L - 3SGE ENGINE	
SL1032	Required for Ferrea Springs # S10073 (16 pieces)
TOYOTA SUPRA 3.0L - DOHC 24 VALVE (7MGE-TURBO 7MGTE) - 1986-1992	
SL1104	Required for Ferrea Spring #S10120 (24 pieces)
TOYOTA GT86 2.0L - DOHC 16 VALVE (4U-GSE) EUROPE - 2012-2015	
SL1139	Required for Ferrea Springs #S10154 (16 Pieces)
SL1140	Required for Ferrea Springs #S10155 (16 Pieces)
VW 1.8T -DOHC 20 VALVE - 1998-2005	
SL1025	Intake (12 pieces) Required for Ferrea Spring #S10055
SL1026	Exhaust (8 pieces) Required for Ferrea Spring #S10056
VW BEETLE/GOLF/JETTA/RABBIT 2.5L - DOHC 20 VALVE (BTW) - 2005 1/2 - 2009	
SL1145	Required for Ferrea Spring # S10162 (20 pieces)
VW GOLF / JETTA 1.8 L - DOHC 16 VALVE (PL) - 1987-1989	
VW SCIROOCO 1.8 L - DOHC 16 VALVE (PL) - 1986-1988	
SL1073	Required for Ferrea Spring #S10115 (16 pieces)
VW GOLF / JETTA 2.0 L - DOHC 16 VALVE (9A) - 1990-1992	
VW PASSAT 2.0 L - DOHC 16 VALVE (9A) - 1990-1994	
SL1073	Required for Ferrea Spring #S10115 (16 pieces)
VW VR6 R32 3.2L- DOHC 24 VALVE 2004-2011	
SL1131	Required for Ferrea Spring #S10148 (OD) (24 Pieces)
SL1132	Required for Ferrea Spring #S10148 (ID) (24 Pieces)
VW 2.0T FSI - DOHC 16 VALVE - 2006-2008	
VW 2.0T TSI - DOHC 16 VALVE - 2009-2013	
VW GOLF R 2.0T TSI - DOHC 16 VALVE - 2015-2016	
SL1142	Required for Ferrea Springs #S10157 (16 Pieces)

LASH CAPS

Part#	Specifications
LASH CAPS	
C10004	5.5 mm - .216 ID - .100 Deep
C10008	6 mm - .2358 ID - .085 Deep
C10020	6 mm - .236 ID - .118 Deep. For Audi - VW Camshaft applications
C10011	6.08 mm - .239 ID - .120 Deep Ford Focus 2.0L (for Valve Stem Stock size)
C10005	7 mm - .274 ID - .160 Deep. To be used with Superlock

LIFTER SHIMS

Part# Specifications

AUDI 2.0T FSI - DOHC 16 VALVE - 2006-2008

VW 2.0T FSI - DOHC 16 VALVE - 2006-2008

LP1100 Lifter Shim (16 pieces). 1 mm thick

LP1105 Lifter Shim (16 pieces). High RPM race application. 1.65 mm thick

Note: Lifter shim goes below stock hydraulic lifter to shorten travel distance.

AUDI TT VR6 3.2L - DOHC 24 VALVE (BHE-CBRA) 2005-2009

LP1104 Lifter Shim (24 pieces) 1 mm thick

Note: Lifter shim goes below stock hydraulic lifter to shorten travel distance.

AUDI TTRS / RS3 2.5L TFSI - DOHC 20 VALVE (DAZA) TURBO - 2017-2018

LP1107 Lifter Shim (20 pieces). 1 mm thick

Note: Lifter shim goes below stock hydraulic lifter to shorten travel distance.

LAMBORGHINI V10 5.0L - DOHC 40 VALVE - 2003-2007

LP1106 Lifter Shim (40 pieces) 1 mm thick

Note: Lifter shim goes below stock hydraulic lifter to shorten travel distance.

VW VR6 2.8L - DOHC 24 VALVE (BDF) - 2002-2004

LP1101 Lifter Shim (24 pieces) 1 mm thick

Note: Lifter shim goes below stock hydraulic lifter to shorten travel distance.

VW BEETLE/GOLF/JETTA/RABBIT 2.5L - DOHC 20 VALVE (BTW) - 2005 - 1/2-2009

LP1102 Lifter Shim (20 pieces) 1 mm thick

Note: Lifter shim goes below stock hydraulic lifter to shorten travel distance.

VW VR6 R32 3.2L - DOHC 24 VALVE 2004-2011

LP1103 Lifter Shim (24 pieces) 1 mm thick

Note: Lifter shim goes below stock hydraulic lifter to shorten travel distance.

COPPER BRONZE VALVE GUIDES

Part# Specifications

ACURA / HONDA

VG1089 Exhaust -.002 Under size. Use Ferrea Valve Seal Part # VS1002

VG1000 Exhaust Std. size. Use Ferrea Valve Seal Part# VS1002

VG1001 Exhaust + .001 Over size. Use Ferrea Valve Seal Part# VS1002

VG1090 Intake -.002 Under size. Use Ferrea Valve Seal Part # VS1003

VG1002 Intake Std size. Use Ferrea Valve Seal Part# VS1003

VG1003 Intake + .001 Over size. Use Ferrea Valve Seal Part# VS1003

ACURA RSX 2.0L - DOHC VTEC 16 VALVE (K20) - 2001-2006

VG1064 Exhaust Std. size. Use Ferrea Valve Seal Part# VS1002

VG1065 Exhaust + .001 Over size. Use Ferrea Valve Seal Part# VS1002

VG1062 Intake Std. size. Use Ferrea Valve Seal Part# VS1003

VG1063 Intake + .001 Over size. Use Ferrea Valve Seal Part# VS1003

ACURA TSX 2.4L - DOHC i-VTEC 16 VALVE (K24Z3) - 2009-2014

ACURA ILX 2.4L - DOHC i-VTEC 16 VALVE (K24Z7) - 2013-2015

VG1095 Exhaust Std. size. Use Ferrea Valve Seal Part# VS1002

VG1096 Exhaust + .001 Over size. Use Ferrea Valve Seal Part# VS1002

VG1097 Intake Std. size. Use Ferrea valve Seal Part# VS1003

VG1098 Intake + .001 Over size. Use Ferrea Valve Seal Part# VS1003

HONDA S 2000 (F20C) - 2000-2003 / HONDA S 2000 (F22C) - 2004-2008

VG1056 Exhaust Std. size. Use Ferrea Valve Seal Part# VS1002

VG1057 Exhaust + .001 Over size. Use Ferrea Valve Seal Part# VS1002

VG1092 Exhaust Std. size. Use with Factory OEM seat locator and Ferrea Valve Seal Part # VS1002

VG1058 Intake Std size. Use Ferrea Valve Seal Part# VS1003e Ferrea Valve Seal Part# VS1003

VG1059 Intake + .001 Over size. Use Ferrea Valve Seal Part# VS1003

VG1091 Intake Std. size. Use with Factory OEM seat locator and Ferrea Valve Seal Part # VS1003

FORD ESCORT 2.0L - DOHC ZETEC 16 VALVE (ZX2) - 1999-2001

FORD FOCUS 2.0L - DOHC ZETEC 16 VALVE (ZX3) - 2000-2001

VG1006 Intake Std. To be used with 5.5 mm stem valve. Use Ferrea Valve Seal Part# VS1001

VG1007 Exhaust Std. To be used with 5.5 mm stem valve. Use Ferrea Valve Seal Part# VS1000

FORD 2.3L - DOHC ZETEC 16 VALVE - 2002

VG1015 Intake Std. To be used with 5.5 mm stem valve. Use Ferrea Valve Seal Part# VS1001

VG1016 Exhaust Std. To be used with 5.5 mm stem valve. Use Ferrea Valve Seal Part# VS1000

HONDA CIVIC TYPE-R 2.0L - DOHC VTEC 16 VALVE (K20C1-TURBO) - 2017-2018

VG1100 Exhaust Std. size. Use Ferrea Valve Seal Part# VS1002

VG1101 Exhaust + .001 Over size. Use Ferrea Valve Seal Part# VS1002

VG1102 Intake Std. size. Use Ferrea valve Seal Part# VS1003

VG1103 Intake + .001 Over size. Use Ferrea Valve Seal Part# VS1003

HONDA ACCORD LX 2.4L - DOHC i-VTEC 16 VALVE (K24Z2) - 2008-2012

HONDA CIVIC Si 2.4L - DOHC i-VTEC 16 VALVE (K24Z7) - 2012-2015

VG1095 Exhaust Std. size. Use Ferrea Valve Seal Part# VS1002

VG1096 Exhaust + .001 Over size. Use Ferrea Valve Seal Part# VS1002

VG1097 Intake Std. size. Use Ferrea valve Seal Part# VS1003

VG1098 Intake + .001 Over size. Use Ferrea Valve Seal Part# VS1003

INFINITI V6 3.0L - DOHC 24 VALVE (VR30DDTT) - 2015-2018

VG1109 Exhaust Std. size. Use Ferrea Valve Seal Part# VS1033

VG1110 Intake Std. size. Use Ferrea Valve Seal Part# VS1034

COPPER BRONZE VALVE GUIDES

Part# Specifications

MITSUBISHI ECLIPSE GS-GST 2.0L - DOHC 16 VALVE (4G63-4G63T) - 1990-1999 MITSUBISHI EVOLUTION VIII 2.0L - DOHC 16 VALVE (TURBO 4G63T) - 2003-2007

VG1048 Exhaust Std. size. Use Ferrea Valve Seal Part# VS1010.
VG1049 Exhaust + .001 Over size. Use Ferrea Valve Seal Part# VS1010.
VG1050 Intake Std. size. Use Ferrea Valve Seal Part# VS1011.
VG1051 Intake + .001 Over size. Use Ferrea Valve Seal Part# VS1011.

MITSUBISHI EVOLUTION X 2.0L - DOHC 16 VALVE (4B11T) - 2007-2009

VG1077 Exhaust Std. size. Use Ferrea Valve Seal Part# VS1024.
VG1078 Exhaust + .001 Over size. Use Ferrea Valve Seal Part# VS1024.
VG1079 Intake Std. size. Use Ferrea Valve Seal Part# VS1025.
VG1080 Intake + .001 Over size. Use Ferrea Valve Seal Part# VS1025.

NISSAN 350 Z 3.5 L - V-6 - DOHC 24 VALVE (VQ35) - 2003-2008

VG1038 Intake Std. size. Use Ferrea Valve Seal Part# VS1014.
VG1039 Intake + .001 Over size. Use Ferrea Valve Seal Part# VS1014.
VG1040 Exhaust Std. size. Use Ferrea Valve Seal Part# VS1012.
VG1041 Exhaust + .001 Over size. Use Ferrea Valve Seal Part# VS1012.
VG1099 Exhaust 7mm Std. size. Use Ferrea Valve Seal Part# VS1028

NISSAN GT-R 3.8 L V-6 - DOHC 24 VALVE (VR38DETT) - 2009-2010

VG1083 Exhaust Std. size. Use Ferrea Valve Seal Part# VS1012.
VG1084 Exhaust + .001 Over size. Use Ferrea Valve Seal Part# VS1012.
VG1085 Intake Std. size. Use Ferrea Valve Seal Part# VS1014.
VG1086 Intake + .001 Over size. Use Ferrea Valve Seal Part# VS1014.

SUBARU WRX 2.0L - DOHC 16 VALVE (EJ20) - 2001-2008

SUBARU WRX 2.0L - DOHC 16 VALVE (STI) - 2004-2008

VG1071 Exhaust Std. size. Use Ferrea Valve Seal Part# VS1015.
VG1072 Exhaust + .001 Over size. Use Ferrea Valve Seal Part# VS1015.
VG1073 Intake Std. size. Use Ferrea Valve Seal Part# VS1016.
VG1074 Intake + .001 Over size. Use Ferrea Valve Seal Part# VS1016.

TOYOTA FJ CRUISER V6 4.0L - DOHC 24 VALVE (1GR-FE) - 2006-2008

VG1081 Exhaust Std. size. For Turbo applications
VG1082 Intake Std size

TOYOTA LANDCRUISER 4.5L - DOHC 24 VALVE (1FZFE) - 1993-1997

VG1075 Exhaust Std. size. For Turbo Applications
VG1076 Intake Std size

TOYOTA SUPRA 3.0L I/L 6 CYL - DOHC 24 VALVE (2JZGE-2JZGTE) - 1994-1998

VG1034 Exhaust Std. size. Use Ferrea Valve Seal Part# VS1008.
VG1037 Exhaust + .001 Over size. Use Ferrea Valve Seal Part# VS1008.
VG1112 Exhaust 7mm Std. size. Use Ferrea Valve Seal Part# VS1035
VG1035 Intake Std size. Use Ferrea Valve Seal Part# VS1009.
VG1036 Intake + .001 Over size. Use Ferrea Valve Seal Part# VS1009.

TOYOTA SUPRA 3.0L - DOHC 24 VALVE (B58) TURBO - 2019

VG1113 Exhaust 6 mm Std. size. Use Ferrea Hat Seat locator and Viton Valve Seal # SL1175
VG1114 Exhaust 6 mm +.001 Over size. Use Ferrea Hat Seat Locator and Viton Valve Seal # SL1175
VG1115 Intake 5 mm Std. size. Use Ferrea Hat Seat Locator and Viton Valve Seal # SL1176
VG1116 Intake 5 mm +.001 Over size. Use Ferrea Hat Seat Locator and Viton Valve Seal # SL1176

VALVE SEALS

Part# Specifications

ACURA / HONDA

VS1002 Exhaust. 5.5 mm valve stem. Viton rubber compound. Hi Temp
VS1003 Intake. 5.5 mm valve stem. Viton rubber compound

Note: These Valve Seals can be used in the following Acura and Honda engines: B17A1 / B18C1-C3 / B18A1-B1 / K20 / K20C1-Turbo / K24Z3-Z7 / K24Z2-Z7 / F22B2-F22B6 F22B1 / D16A6 / D16Z6-Y5-Y7-Y8 / B16A1-B16A3 / H22A1-A4 / F20C-F22C

AUDI / VW

VS1029 Exhaust 6 mm valve stem. Viton rubber compound. Hi Temp.
VS1030 Intake 6 mm valve stem. Viton rubber compound. Hi Temp.

DODGE NEON 2.4 - SRT4 - DOHC 16 VALVE (A853) - 2003-2005

VS1017 Intake 6mm valve stem. Poly rubber compound. The seal include the Stock Spring Seat Locator
VS1018 Exhaust 6mm valve system. Viton rubber compound. Hi Temp. The seal include the Stock Spring Seat Locator

FORD ESCORT 2.0L - DOHC ZETEC 16 VALVE (ZX2) - 1999-2001

FORD FOCUS 2.0L - DOHC ZETEC 16 VALVE (ZX3) - 2000-2001

VS1000 Exhaust. 5.5 mm valve stem. Viton rubber compound. Hi Temp
VS1001 Intake. 5.5 mm valve stem. Viton rubber compound

INFINITI V6 3.0L - DOHC 24 VALVE (VR30DDTT) - 2015-2018

VS1033 Exhaust 5.5 mm valve stem. Viton rubber compound. Hi Temp.
VS1034 Intake 5.5 mm valve stem. Viton rubber compound. Hi Temp.

MITSUBISHI ECLIPSE GS-GST 2.0L - DOHC 16 VALVE (4G63-4G63T) - 1990-1999

MITSUBISHI EVOLUTION VIII 2.0L - DOHC 16 VALVE (TURBO 4G63T) - 2003-2007

VS1010 Exhaust 6.55 mm valve stem. Viton rubber compound. Hi Temp.
VS1011 Intake 6.57 mm valve stem. Viton rubber compound.

MITSUBISHI EVOLUTION X 2.0L - DOHC 16 VALVE (4B11T) - 2007-2009

VS1024 Exhaust. 5.5 mm valve stem. Viton rubber compound. Hi Temp.
VS1025 Intake 5.5mm valve stem. Viton rubber compound.

NISSAN SKYLINE 6 CYL IN LINE - 24 VALVE - (RB25DET) - 1993-1997

VS1022 Exhaust 6.00 mm valve stem. Viton rubber compound. Hi Temp.
VS1023 Intake 6.00 mm valve stem. Viton rubber compound. Hi Temp.

VALVE SEALS

Part# Specifications

NISSAN 350 Z 3.5 L - V-6 - DOHC 24 VALVE (VQ35) - 2003-2008

NISSAN GT-R 3.8 L - V6 - DOHC 24 VALVE (VR38DETT) - 2009-2010

VS1012 Exhaust 6 mm valve stem. Viton rubber compound. Hi Temp.

VS1014 Intake 6 mm valve stem. Viton rubber compound.

VS1028 Exhaust 7 mm valve stem. Viton rubber compound. Hi Temp.

SUBARU WRX 2.0L - DOHC 16 VALVE (EJ20) - 2001-2008

SUBARU WRX 2.0L - DOHC 16 VALVE (STI) - 2004-2008

VS1015 Exhaust 6 mm valve stem. Viton rubber compound. Hi Temp

VS1016 Intake 6 mm valve stem. Viton rubber compound

TOYOTA SUPRA 3.0L I/L 6 CYL - DOHC 24 VALVE (2JZGE-2JZGTE) - 1994-1998

VS1008 Exhaust 6 mm valve stem. Viton rubber compound. Hi Temp.

VS1009 Intake 6 mm valve stem. Viton rubber compound.

VS1035 Exhaust 7 mm valve stem. Viton rubber compound. Hi Temp



HIGH POWER VALVETRAIN COMPONENTS

2020
APPLICATION
GUIDE

MOTORCYCLE

TITANIUM COMPETITION VALVES

Part#	Type	Head Diam.	Stem Diam.	Overall Length	Tip Length	References
HARLEY DAVIDSON DRAG RACE						
F0401	E	1.750	.310	5.600	BLANK	25°
F0402	E	1.850	.310	5.600	BLANK	22°
F1384	E	2.000	5/16	7.000	BLANK	22° Tulip Flo.
F0089	I	2.100	5/16	5.600	BLANK	22° Tulip
F0084	E/I	2.300	5/16	6.500	BLANK	25° Flo.
HONDA CRF 450 (2002-2006) - MOTOCROSS						
F0410	I	36 mm	5.48 mm	84.63 mm	1.15 mm	20° Flo. Dish Head. Stock size.
F0409	I	37 mm	5.48 mm	84.63 mm	1.15 mm	20° Flo. Dish Head. - 1mm oversize.
F0408	I	38 mm	5.48 mm	84.63 mm	1.15 mm	20° Flo. Dish Head. - 2mm oversize
HONDA CRF 450 (2007-2008) - MOTOCROSS						
F0410	I	36 mm	5.48 mm	84.63 mm	1.15 mm	20° Flo. Dish Head. Stock size.
F0409	I	37 mm	5.48 mm	84.63 mm	1.15 mm	20° Flo. Dish Head. - 1mm oversize.
F0408	I	38 mm	5.48 mm	84.63 mm	1.15 mm	20° Flo-Dish Head. + 2mm oversize.
KAWASAKI 250 (2004) - MOTOCROSS						
F0412	E	25 mm	4.46 mm	79.1 mm	1.03 mm	25° Flo. Stock
F0414	E	26 mm	4.46 mm	79.1 mm	1.03 mm	25° Flo. + 1mm oversize
F0411	I	31 mm	4.48 mm	78.93 mm	1.03 mm	20° Flo. Stock
F0413	I	32 mm	4.48 mm	78.93 mm	1.03 mm	20° Flo. + 1mm oversize
SUZUKI 250 (2004) - MOTOCROSS						
F0412	E	25 mm	4.46 mm	79.1 mm	1.03 mm	25° Flo. Stock
F0414	E	26 mm	4.46 mm	79.1 mm	1.03 mm	25° Flo. + 1mm oversize
F0411	I	31 mm	4.48 mm	78.93 mm	1.03 mm	20° Flo. Stock
F0413	I	32 mm	4.48 mm	78.93 mm	1.03 mm	20° Flo. + 1mm oversize
SUZUKI GSXR 750 - ROAD RACE						
F0088	E	24 mm	4.5 mm	96.4 mm	1.6 mm	15° Flo
F0087	I	29 mm	4.5 mm	96.3 mm	1.6 mm	15° Flo
BLANKS						
F0426	E	26 mm	3.97mm	100mm	BLANK	20° Back angle. Flo. Hi Temp.
F0427	E	28 mm	3.97mm	100mm	BLANK	20° Back angle. Flo. Hi Temp.
F0432	I	30 mm	3.98mm	100mm	BLANK	17° Back angle. Flo.
F0433	I	32 mm	3.98mm	100mm	BLANK	17° Back angle. Flo.
F0430	E	26 mm	4.46mm	100mm	BLANK	22° Back angle. Flo. Hi Temp.
F0431	E	28 mm	4.46mm	100mm	BLANK	22° Back angle. Overcut Flo. Hi Temp.
F0428	I	32 mm	4.48mm	100mm	BLANK	20° Back angle. Flo.
F0429	I	34 mm	4.48mm	100mm	BLANK	22° Back angle. Flo.
F0404	E	30 mm	4.98mm	135mm	BLANK	20° Flo. Hi Temp.
F0429	I	34 mm	4.48mm	100mm	BLANK	22° Back angle. Flo.
F0403	I	35 mm	4.98mm	135mm	BLANK	17° Super Flo.
F0255	E	33 mm	5.47mm	135mm	BLANK	19° Flat Head
F0254	I	41 mm	5.48mm	135mm	BLANK	19° Flat Head
F0042	E	32 mm	5.5mm	145mm	BLANK	26° Tulip Flo.
F0043	I	38 mm	5.5mm	135mm	BLANK	26° Tulip Super Flo.
F0235	E	34 mm	5.95mm	135mm	BLANK	21° Flo. Dish Head
F0234	I	40 mm	5.97mm	135mm	BLANK	19° Super Flo. Flat Head
F0405	E	40 mm	5.98mm	135mm	BLANK	16° Flo.
F0407	E	40 mm	5.98mm	135mm	BLANK	25° Flo.
F0436	I	40mm	5.98mm	145mm	BLANK	12° Taper Flo. Flat Head
F0437	E/I	45mm	5.98mm	145mm	BLANK	12° Flo. Flat Head
F0406	E/I	50 mm	5.98mm	145mm	BLANK	12° Flo.
F0083	E/I	1.500	.247	4.800	BLANK	10° Super Flo-Go Kart & Jr. Dragster
F0040	E	40 mm	7mm	145mm	BLANK	26° Tulip Super Flo-Pro Stock
F0400	E	40 mm	7mm	145mm	BLANK	30° Tulip Super Flo-Pro Stock
F0041	I	50 mm	7mm	145mm	BLANK	25° Tulip Super Flo-Pro Stock
F0056	I	50 mm	7mm	145mm	BLANK	15° Super Flo-Pro Stock
F0420	I	50 mm	7mm	145mm	BLANK	19° Super Flo-Pro Stock
F0422	E	32.5 mm	7.095mm	145mm	BLANK	30°
F0421	I	39 mm	7.1mm	145mm	BLANK	19°
F0401	E	1.750	.310	5.600	BLANK	25° HARLEY
F0402	E	1.850	.310	5.600	BLANK	22° HARLEY
F0089	I	2.100	.310	5.600	BLANK	22° HARLEY
F0084	E/I	2.300	5/16	6.500	BLANK	25° Flo.

HOLLOW STEM VALVES

Part#	Type	Head Diam.	Stem Diam.	Overall Length	Tip Length	References
HARLEY DAVIDSON - EVOLUTION (1984/1998)						
F1055P	E	1.625	.310	4.531	.200	24° Super Flo. Special Alloy
F1054P	I	1.940	.310	4.444	.200	24° Super Flo. Special Alloy

(* Additional wear resistant coatings such as CrN or DLC can be applied to valve seat and/or tip areas at an extra charge. Please contact a Ferrea sales representative for pricing.

MOTORCYCLE COMPETITION VALVES

Part#	Type	Head Diam.	Stem Diam.	Overall Length	Tip Length	References
-------	------	------------	------------	----------------	------------	------------

HARLEY DAVIDSON APPLICATIONS

BUELL XB9 (2002 - 2003)

F0302	E	1.575	.2754	4.610	.100	25° Flo. Stock Size. Triple Groove
F0303	E	1.615	.2754	4.610	.100	25° Flo. Over Size. Triple Groove
F0300	I	1.810	.2755	4.520	.100	25° Super Flo. Stock Size. Triple Groove
F0301	I	1.840	.2755	4.520	.100	25° Super Flo. Over Size. Triple Groove

HARLEY DAVIDSON - EVOLUTION & TWIN CAM (1984/2004)

F0145	E	1.615	.310	4.531	.200	24° Flo. Stock Size
F0275	E	1.615	.310	4.531	.200	40° Flo. Stock Size
F0045	E	1.625	.310	4.531	.200	24° Flo. Oversize
F0251	E	1.625	.310	4.430	.180	Harley/Edelbrock
F0503	I	1.944	.310	4.444	.200	25° Flo. Over Size. Dish Head. Black Nitride
F0504	I	2.022	.310	4.438	.205	25° Flo. Dish Head. Black Nitride

HARLEY DAVIDSON - EVOLUTION (1984/1998)

F0285	E	1.625	.310	4.511	.180	24° Flo. Over size. Harley/Edelbrock
F0143	E	1.750	.310	4.531	.200	24° Flo. Oversize
F0144	I	1.850	.310	4.444	.200	24° Flo. Stock Size
F0046	I	1.900	.310	4.444	.200	24° Flo. Oversize
F0284	I	1.940	.310	4.424	.180	24° Flo. Over size. Harley/Edelbrock
F0044	I	1.940	.310	4.444	.200	24° Flo. Oversize
F0252	I	2.000	.310	4.345	.180	Harley/Edelbrock
F0146	I	2.000	.310	4.444	.200	24° Flo. Oversize
F0317	I	2.100	.310	4.444	.200	24° Super Flo. Oversize

HARLEY DAVIDSON - SHOVEL HEAD (1966/1984)

F0505	E	1.750	.375	3.830	.200	25° Flo. Dish Head. Black Nitride
F0027	E	1.755	.308	3.820	.205	28° Flo
F0026	I	1.950	.308	3.890	.183	21° Flo
F0506	I	1.956	.375	3.884	.200	20° Super Flo. Dish Head. Black Nitride

HARLEY DAVIDSON - TWIN CAM (2005-2008)

F0349	E	1.575	.2754	4.531	.080	25° Flo. Stock size. Triple Groove
F0318(*)	E	1.615	.2754	4.561	.100	25° Flo. Oversize. Single Radial Groove
F0319	I	1.810	.2755	4.425	.080	22° Super Flo. Stock size. Triple Groove
F0320(*)	I	1.900	.2755	4.440	.100	22° Super Flo. Oversize. Single Radial Groove

Tech Note: (*) Ferrea valves with single radial groove must use Valve Lock # K10062. This Valve Lock works with either, Ferrea Titanium Retainer # E12028 or Factory Supplied Retainer.

HARLEY DAVIDSON - VRSCA V ROD (2002-2003)

F0210	E	34.4 mm	5.95 mm	116.98 mm	1.8 mm	21° Flo. Stock Size. Triple Groove
F0212	E	35.4 mm	5.95 mm	116.98 mm	1.8 mm	21° Flo. Over size. Triple Groove
F0209	I	40 mm	5.97 mm	116.28 mm	1.8 mm	19° Super Flo. Stock Size. Triple Groove
F0211	I	41 mm	5.97 mm	116.28 mm	1.8 mm	19° Super Flo. Over size. Triple Groove

HARLEY DAVIDSON - MILWAUKEE EIGHT (2016-2019)

F0522	E	1.260	.235	4.060	0.090	21° Taper Flo. Stock size. Triple Groove
F0523	E	1.300	.235	4.060	0.090	21° Taper Flo. Over size. Triple Groove
F0524	I	1.575	.235	4.040	0.090	19° Super Flo. Stock size. Triple Groove
F0525	I	1.615	.235	4.040	0.090	19° Super Flo. Over size. Triple Groove

HARLEY DAVIDSON XL 883

F0312	E	1.350	.310	4.645	.200	24° Flo. Super Alloy
F0311	I	1.590	.310	4.526	.200	24° Flo.

HARLEY DAVIDSON (TITANIUM) DRAG RACE

F0401	E	1.750	.310	5.600	BLANK	25°
F0402	E	1.850	.310	5.600	BLANK	22°
F1384	E	2.000	5/16	7.000	BLANK	22° Tulip Flo.
F0089	I	2.100	5/16	5.600	BLANK	22° Tulip
F0084	E/I	2.300	5/16	6.500	BLANK	25° Flo.

MOTORCYCLE COMPETITION VALVES

Part#	Type	Head Diam.	Stem Diam.	Overall Length	Tip Length	References
-------	------	------------	------------	----------------	------------	------------

OFFROAD MOTORCYCLE APPLICATIONS

CAN AM 800R - ROTAX TWIN (2005-2012) - ATV - ROCKERS

F0381 (*)	E	29mm	4.97mm	90.40mm	3.1mm	25° Taper Flo. Stock size. Special Alloy. Triple Groove
F0382 (*)	E	30mm	4.97mm	90.40mm	3.1mm	25° Taper Flo. + 1mm Oversize. Special Alloy. Triple groove
F0383 (*)	I	35mm	4.98mm	91.20mm	3.3mm	20° Super Flo. Stock size. Triple Groove

(*) NOTE: These valves are not stock inventory items. The valves will be made to order.

A nominal labor charge will be added to the cost of the valve. Please contact us for the labor charge.

CAN AM MAVERICK X3 - DOHC 12 VALVE (2017-2019) - UTV - TURBO

F0526 (*)	E	25 mm	4.96mm	85.55 mm	2.5 mm	19° Taper Flo. Stock size. Super Alloy
F0527 (*)	E	26 mm	4.96mm	85.55 mm	2.5 mm	19° Taper Flo. +1mm Over size. Super Alloy
F0528	I	29 mm	4.97mm	84.35 mm	3 mm	15° Super Flo. Stock size. Special Alloy
F0529	I	30 mm	4.97mm	84.35 mm	3 mm	15° Super Flo. +1mm Over size. Special Alloy
F0530	I	31 mm	4.97mm	84.35 mm	3 mm	15° Super Flo. +2mm Over size. Special Alloy

(*) NOTE: The Factory OE exhaust valve has a very thin margin thickness, Ferrea exhaust valve margin thickness is increased to 1 mm and the overall length is also increased to match so the Factory OE spring install height is maintained.

HONDA CRF 250R (2004/2007) - MOTOCROSS

F0329	E	26.00 mm	4.97 mm	82.15 mm	1.0 mm	19° Flo. Dish Head. Stock size
F0330	E	27.00 mm	4.97 mm	82.15 mm	1.0 mm	19° Flo. Dish Head. + 1 mm oversize
F0355	I	31.10 mm	4.98 mm	82.90 mm	1.0 mm	20° Super Flo. Dish Head. Stock size
F0331	I	31.10 mm	4.98 mm	83.40 mm	1.0 mm	20° Super Flo. Dish Head. Stock size
F0356	I	32.10 mm	4.98 mm	82.90 mm	1.0 mm	20° Super Flo. Dish Head. +1 mm oversize
F0332	I	32.10 mm	4.98 mm	83.40 mm	1.0 mm	20° Super Flo. Dish Head. + 1 mm oversize

MOTORCYCLE COMPETITION VALVES

Part#	Type	Head Diam.	Stem Diam.	Overall Length	Tip Length	References
-------	------	------------	------------	----------------	------------	------------

OFFROAD MOTORCYCLE APPLICATIONS

HONDA CRF 250R (2008-2009) - MOTOCROSS

F0357	E	26.00 mm	4.47 mm	82.15 mm	1.0 mm	19° Flo. Dish Head. Stock size
F0358	E	27.00 mm	4.47 mm	82.15 mm	1.0 mm	19° Flo. Dish Head. + 1 mm oversize
F0355	I	31.10 mm	4.98 mm	82.90 mm	1.0 mm	20° Super Flo. Dish Head. Stock size
F0356	I	32.10 mm	4.98 mm	82.90 mm	1.0 mm	20° Super Flo. Dish Head. + 1 mm oversize

TECH NOTE: The INTAKE valves have an Overall Length -.5 mm shorter than stock length size

HONDA CRF 250R (2010) - MOTOCROSS

F0363	E	25.00 mm	4.45 mm	84.15 mm	1.0 mm	19° Flo. Dish Head. Stock size
F0364	E	26.00 mm	4.45 mm	84.15 mm	1.0 mm	19° Flo. Dish Head. + 1 mm oversize
F0365	I	30.50 mm	4.93 mm	89.00 mm	1.0 mm	20° Super Flo. Backcut 38°. Dish Head. Stock size
F0366	I	31.00 mm	4.93 mm	89.00 mm	1.0 mm	20° Super Flo. Backcut 38°. Dish Head. + .5 mm oversize

HONDA CRF 250R (2010-2015) - MOTOCROSS

F0365	I	30.50 mm	4.93 mm	89.00 mm	1.0 mm	20° Super Flo. Backcut 38°. Dish Head. Stock size
F0366	I	31.00 mm	4.93 mm	89.00 mm	1.0 mm	20° Super Flo. Backcut 38°. Dish Head. + .5 mm oversize

HONDA CRF 250R (2016-2017) - MOTOCROSS

F0518	E	25 mm	4.97 mm	84.15 mm	1 mm	20° Flo. Flat Face. Stock size
F0519	E	26 mm	4.97 mm	84.15 mm	1 mm	20° Flo. Flat Face. + 1mm oversize
F0520	I	30.5 mm	4.98 mm	89.00 mm	1 mm	17° Super Flo. Flat Face. Stock size
F0521	I	31.5 mm	4.98 mm	89.00 mm	1 mm	17° Super Flo. Flat Face. +1mm oversize

HONDA CRF 250R (2018) - MOTOCROSS

F0515	E	26mm	4.97mm	80.9mm	1.6mm	20° Taper Flo. Flat Face. Stock size
F0516	E	26.5mm	4.97mm	80.9mm	1.6mm	20° Taper Flo. Flat Face. +.5mm oversize
F0517	I	33mm	4.98mm	88.1mm	1.6mm	15° Super Flo. Flat Face. Stock size

HONDA CRF 450 (2002-2006) - MOTOCROSS

F0308	E	31 mm	4.965 mm	84.25 mm	1.15 mm	19° Flo. Dish Head. Stock size
F0299	E	32 mm	4.97 mm	84.25 mm	1.15 mm	19° Flo. Dish Head. Over Size.
F0248	I	36 mm	5.49 mm	84.6 mm	1.15 mm	20° Flo. Dish Head. Stock size. Black Nitride
F0305	I	36 mm	5.49 mm	84.6 mm	1.15 mm	20° Super Flo. Dish Head. Stock size
F0410	I	36 mm	5.48 mm	84.63 mm	1.15 mm	20° Flo. Dish Head. Stock size. Titanium
F0304	I	37 mm	5.49 mm	84.6 mm	1.15 mm	20° Super Flo. Dish Head. - 1mm oversize
F0409	I	37 mm	5.48 mm	84.63 mm	1.15 mm	20° Flo. Dish Head. - 1mm oversize. Titanium
F0408	I	38 mm	5.48 mm	84.63 mm	1.15 mm	20° Flo-Dish Head. + 2mm Over Size.TITANIUM

HONDA CRF 450 (2007-2008) - MOTOCROSS

F0359	E	30 mm	4.965 mm	84.25 mm	1.15 mm	19° Flo. Dish Head. Stock size
F0308	E	31 mm	4.965 mm	84.25 mm	1.15 mm	19° Flo. Dish Head. + 1 mm o/size
F0299	E	32 mm	4.97 mm	84.25 mm	1.15 mm	19° Flo. Dish Head. 2 mm oversize.
F0248	I	36 mm	5.49 mm	84.6 mm	1.15 mm	20° Flo. Dish Head. Stock size. Black Nitride
F0305	I	36 mm	5.49 mm	84.6 mm	1.15 mm	20° Super Flo. Dish Head. Stock size
F0410	I	36 mm	5.48 mm	84.63 mm	1.15 mm	20° Flo. Dish Head. Stock size. TITANIUM
F0304	I	37 mm	5.49 mm	84.6 mm	1.15 mm	20° Super Flo. Dish Head. - 1mm oversize
F0409	I	37 mm	5.48 mm	84.63 mm	1.15 mm	20° Flo. Dish Head. - 1mm oversize. TITANIUM
F0408	I	38 mm	5.48 mm	84.63 mm	1.15 mm	20° Flo-Dish Head. + 2mm oversize.TITANIUM

HONDA CRF 450 (2009-2012) - MOTOCROSS

F0368	E	30 mm	4.966 mm	80.45 mm	1.15 mm	19° Flo. Stock size.
F0369	E	31 mm	4.966 mm	80.45 mm	1.15 mm	19° Flo. +1 mm Over size.
F0370	I	36 mm	4.975 mm	78.7 mm	1.15 mm	20° Super Flo. Stock size
F0371	I	37 mm	4.975 mm	78.7 mm	1.15 mm	20° Super Flo. +1 mm Over size

HONDA TRX 450 (2002-2005)

F0339	E	30 mm	5.49 mm	84.27 mm	1.15 mm	22° Flo Dish Head. Stock size
F0340	E	31 mm	5.49 mm	84.27 mm	1.15 mm	22° Flo Dish Head. + 1 mm Over size
F0372	E	32 mm	5.49 mm	84.27 mm	1.15 mm	22° Flo Dish Head. +2 mm Over size
F0248	I	36 mm	5.49 mm	84.6 mm	1.15 mm	20° Flo Dish Head. Stock size. Black Nitride
F0305	I	36 mm	5.49 mm	84.6 mm	1.15 mm	20° Super Flo Dish Head. Stock size.
F0410	I	36 mm	5.48 mm	84.63 mm	1.15 mm	20° Flo Dish Head. Stock size. Titanium
F0304	I	37 mm	5.49 mm	84.6 mm	1.15 mm	20° Super Flo Dish Head. + 1 mm Over size
F0409	I	37 mm	5.48 mm	84.63 mm	1.15 mm	20° Flo Dish Head. + 1 mm Over size.Titanium
F0408	I	38 mm	5.48 mm	84.63 mm	1.15 mm	20° Flo Dish Head. + 2 mm Over size.Titanium

HONDA XR 250R (1996-1999)

F0127	E	23.5 mm	4.95 mm	95.63 mm	4.1 mm	30° Flo Dish Head. Stock size.
F0128	E	24.5 mm	4.95 mm	95.63 mm	4.1 mm	30° Flo Dish Head. Stock size. + 1mm over size
F0129	I	28.5 mm	4.97 mm	95.58 mm	4.1 mm	20° Flo Dish Head. Stock size.
F0130	I	29.5 mm	4.97 mm	95.58 mm	4.1 mm	20° Flo Dish Head. Stock size. + 1mm over size

HONDA XR 400R (1996-1999) / HONDA TXR 400EX QUAD (1999)

F0131	E	29 mm	5.45 mm	101 mm	2.9 mm	30° Flo Dish Head. Stock size.
F0132	E	30 mm	5.45 mm	101 mm	2.9 mm	30° Flo Dish Head. Stock size. + 1mm over size
F0133	I	33 mm	5.47 mm	102.64 mm	2.9 mm	20° Flo Dish Head. Stock size.
F0134	I	34 mm	5.47 mm	102.64 mm	2.9 mm	20° Flo Dish Head. + 1mm over size

HONDA XL 600R (1983-1987) / HONDA XR 600R (1985-1999)

F0135	E	31 mm	6.55 mm	104.31 mm	3 mm	29° Flo Dish Head. Stock size
F0136	E	32 mm	6.55 mm	104.31 mm	3 mm	29° Flo Dish Head. + 1mm oversize
F0137	I	36 mm	6.57 mm	105.69 mm	5.15 mm	19° Flo Dish Head. Stock size
F0138	I	37 mm	6.57 mm	105.69 mm	5.15 mm	19° Flo Dish Head. + 1mm oversize

MOTORCYCLE COMPETITION VALVES

Part#	Type	Head Diam.	Stem Diam.	Overall Length	Tip Length	References
HONDA NX 650 (1988-1989) / HONDA XR 650L (1993-1999)						
F0135	E	31 mm	6.55 mm	104.31 mm	3 mm	29° Flo Dish Head. Stock size
F0136	E	32 mm	6.55 mm	104.31 mm	3 mm	29° Flo Dish Head. + 1mm oversize
F0137	I	36 mm	6.57 mm	105.69 mm	5.15 mm	19° Flo Dish Head. Stock size
F0138	I	37 mm	6.57 mm	105.69 mm	5.15 mm	19° Flo Dish Head. + 1mm oversize
KAWASAKI 250 (2004) - MOTOCROSS - (TITANIUM)						
F0412	E	25 mm	4.46 mm	79.1 mm	1.03 mm	25° Flo. Stock
F0414	E	26 mm	4.46 mm	79.1 mm	1.03 mm	25° Flo. + 1mm oversize
F0411	I	31 mm	4.48 mm	78.93 mm	1.03 mm	20° Flo. Stock
F0413	I	32 mm	4.48 mm	78.93 mm	1.03 mm	20° Flo. + 1mm oversize
KAWASAKI KFX 250 (2004-2005) - MOTOCROSS						
F0333	E	25 mm	4.46 mm	79.1 mm	1.03 mm	25° Flo. Stock
F0334	E	26 mm	4.46 mm	79.1 mm	1.03 mm	25° Flo. + 1mm oversize
F0335	I	31 mm	4.48 mm	78.93 mm	1.03 mm	20° Flo. Stock
F0336	I	32 mm	4.48 mm	78.93 mm	1.03 mm	20° Flo. + 1mm oversize
POLARIS RZR XP900 (2011-2012)						
F0373	E	32.5 mm	5.47 mm	96.9 mm	1.8 mm	25° Flo. Dish Head. Stock size. Super Alloy
F0374	E	33 mm	5.47 mm	96.9 mm	1.8 mm	25° Flo. Dish Head. + .5 mm Over size. Super Alloy
F0375	I	38 mm	5.48 mm	96 mm	1.7 mm	19° Super Flo. Dish Head. Stock size
F0376	I	38.5 mm	5.48 mm	96 mm	1.7 mm	19° Super Flo. Dish Head. + .5 mm Over size
POLARIS RZR XP1000 (2014)						
F0388	E	29.2 mm	5.47 mm	96.5 mm	1.8 mm	22° Taper Flo. Dish Head. Stock size. Super Alloy
F0389	E	30.2 mm	5.47 mm	96.5 mm	1.8 mm	22° Taper Flo. Dish Head. +1mm Over size. Super Alloy
F0375	I	38 mm	5.48 mm	96 mm	1.7 mm	19° Super Flo. Dish Head. Stock size
F0376	I	38.5 mm	5.48 mm	96 mm	1.7 mm	19° Super Flo. Dish Head. +.5mm Over size
SUZUKI 250 (2004) - MOTOCROSS - (TITANIUM)						
F0412	E	25 mm	4.46 mm	79.1 mm	1.03 mm	25° Flo. Stock
F0414	E	26 mm	4.46 mm	79.1 mm	1.03 mm	25° Flo. + 1mm oversize
F0411	I	31 mm	4.48 mm	78.93 mm	1.03 mm	20° Flo. Stock
F0413	I	32 mm	4.48 mm	78.93 mm	1.03 mm	20° Flo. + 1mm oversize
SUZUKI RMZ 250 (2004-2005) - MOTOCROSS						
F0333	E	25 mm	4.46 mm	79.1 mm	1.03 mm	25° Flo. Stock
F0334	E	26 mm	4.46 mm	79.1 mm	1.03 mm	25° Flo. + 1mm oversize
F0335	I	31 mm	4.48 mm	78.93 mm	1.03 mm	20° Flo. Stock
F0336	I	32 mm	4.48 mm	78.93 mm	1.03 mm	20° Flo. + 1mm oversize
SUZUKI DRZ 400 (2002-2009)						
F0217	E	29 mm	4.96 mm	81.75 mm	1.70 mm	22° Flo. Stock size
F0218	E	30 mm	4.96 mm	81.75 mm	1.70 mm	22° Flo. + 1 mm oversize
F0215	I	36 mm	4.98 mm	82.65 mm	1.70 mm	20° Super Flo. Stock size
F0216	I	37 mm	4.98 mm	82.65 mm	1.70 mm	20° Super Flo. + 1 mm oversize
YAMAHA YFM 80 - RAPTOR (2002-2004) - MOTOCROSS						
F0225	E	20 mm	4.97 mm	64.75 mm	4 mm	25° Flo. Radial Groove
F0224	I	23 mm	4.98 mm	65.35 mm	3.95 mm	25° Flo. Radial Groove
YAMAHA YZF YZ 400F (1999) - 5 VALVE ENGINE						
F0165	E	27.96 mm	4.95 mm	82.02 mm	1.7 mm	25° Flo Dish Head. Stock size. 2 Valves required
F0166	E	28.96 mm	4.95 mm	82.02 mm	1.7 mm	25° Flo Dish Head. +1mm o/size. 2 Valves required
F0167	I	26.96 mm	4.48 mm	83.28 mm	1.7 mm	15° Flo Dish Head. Stock size. 1 Valve required
F0169	I	26.99 mm	4.48 mm	84.28 mm	1.7 mm	15° Flo Dish Head. Stock size. 2 Valves required
F0168	I	27.96 mm	4.48 mm	83.28 mm	1.7 mm	15° Flo Dish Head. +1mm o/size. 1 Valve required
F0170	I	27.99 mm	4.48 mm	84.28 mm	1.7 mm	15° Flo Dish Head. +1mm o/size. 2 Valves required
YAMAHA YZF 450 - (2003-2009) - MOTOCROSS - 5 VALVE ENGINE						
YAMAHA YZF 450 - (2004-2009) - QUAD - 5 VALVE ENGINE						
F0350	E	28 mm	4.97 mm	75.20 mm	1.77 mm	18° Taper Flo. Stock size.
F0353	E	29 mm	4.97 mm	75.20 mm	1.77 mm	18° Taper Flo. +1mm oversize
F0351	I	27 mm	4.48 mm	76.35 mm	1.71 mm	18° Super Flo. Inner Stock size
F0354	I	28 mm	4.48 mm	76.35 mm	1.71 mm	18° S. Flo. Inner +1mm oversize
F0352	I	27 mm	4.48 mm	77.23 mm	1.71 mm	18° Super Flo. Outer Stock size
F0361	I	28 mm	4.48 mm	77.23 mm	1.71 mm	18° S. Flo. Outer + 1mm oversize
NOTE: This application has 3 intake and 2 exhaust valves per motor. Also, the two Outer Intake valves are longer than the one inner intake valve.						
YAMAHA YFM 660 - RAPTOR (2000-2003)						
F0181	I	30 mm	5.97 mm	100.7 mm	4.8 mm	19° Flo Dish Head. Stock size. 3 Valves required
F0185	I	31 mm	5.97 mm	100.7 mm	4.8 mm	19° S.Flo Dish Head.+1 mm o/size. 3 Valves required
F0182	E	32 mm	5.95 mm	92.70 mm	4.8 mm	25° Flo Dish Head. Stock size. 2 Valves required
F0186	E	33 mm	5.95 mm	92.70 mm	4.8 mm	25° Flo Dish Head. +1 mm o/size. 2 Valves required
YAMAHA 700R - GRIZZLY / RAPTOR / RHINO (2006-2009) - 4 VALVE ENGINE						
F0341	E	32 mm	5.96 mm	96.18 mm	4.3 mm	21° Flo. Radial Groove
F0342	E	33 mm	5.96 mm	96.18 mm	4.3 mm	21° Flo. Radial Groove. + 1mm oversize
F0347	E	34 mm	5.96 mm	96.18 mm	4.3 mm	21° Flo. Radial Groove. + 2mm oversize
F0343	I	38 mm	5.97 mm	102.3 mm	4.5 mm	19° S Flo. Radial Groove.
F0344	I	39 mm	5.97 mm	102.3 mm	4.5 mm	19° S Flo. Radial Groove. + 1 mm oversize
F0348	I	40 mm	5.97 mm	102.3 mm	4.5 mm	19° S Flo. Radial Groove. + 2 mm oversize
F0367	I	41 mm	5.97 mm	102.3 mm	4.5 mm	19° S Flo. Radial Groove. +3 mm oversize

MOTORCYCLE COMPETITION VALVES

Part#	Type	Head Diam.	Stem Diam.	Overall Length	Tip Length	References
-------	------	------------	------------	----------------	------------	------------

ROAD RACE AND DRAG RACE MOTORCYCLE STOCK APPLICATIONS

These parts are normal stock inventory. No other labor charges are applied

KAWASAKI KZ900 (1973-1977) / KAWASAKI KZ1000 (1977-1980)

F0004	E	32.95 mm	6.97 mm	135 mm	BLANK	22° Flo-No Groove-No Tip. Special Alloy
F0038	E	39 mm	6.97 mm	145 mm	BLANK	22° Tulip Flo-No Groove-No Tip
F0014	E	31 mm	7 mm	90 mm	5 mm	22° Flo. Oversize
F0345	E	33 mm	7 mm	135 mm	BLANK	22.5° Tulip Flo. Super Alloy
F0346	E	39 mm	7 mm	135 mm	BLANK	22.5° Tulip Flo. Dish Head. Super Alloy
F0015	I	37.5 mm	7 mm	92 mm	5 mm	20° Flo. Oversize

KAWASAKI J MODEL 1000 (1981-1982) / KAWASAKI GPZ1100 (1981-1982)

F0004	E	32.95 mm	6.97 mm	135 mm	BLANK	22° Flo-No Groove-No Tip. Special Alloy
F0034	E	36 mm	6.97 mm	145 mm	BLANK	22° Flo-No Groove-No Tip. Special Alloy
F0038	E	39 mm	6.97 mm	145 mm	BLANK	22° Tulip Flo-No Groove-No Tip
F0002	I	41.95 mm	6.97 mm	135 mm	BLANK	20° Flo-No Groove-No Tip. Special Alloy
F0003	E	32 mm	7 mm	89.3 mm	4.9 mm	22° Flo. Stock Size
F0001	I	38.5 mm	7 mm	90.5 mm	4.8 mm	20° Flo. Oversize (J model)
F0002	I	42 mm	7 mm	114 mm	BLANK	20° Flo-No Groove-No Tip
F0039	I	46 mm	7 mm	135 mm	BLANK	16° Super Flo-No Groove-No Tip

KAWASAKI ZX10 (2004-2005) -BUCKET

F0326	E	25.5 mm	4.46 mm	91.41 mm	1.45 mm	12° Flo. Dish Head. Stock Size
F0327	I	31 mm	4.48 mm	90.6 mm	1.45 mm	12° Flo. Dish Head. Stock Size

KAWASAKI ZX12 (2000-2002) -BUCKET

F0180	E	28.35 mm	4.95 mm	98.52 mm	1.35 mm	12° Flo Dish Head. Stock size
F0179	I	33.39 mm	4.97 mm	97.80 mm	1.35 mm	10° Flo Dish Head. Stock Size
F0325	I	34.39 mm	4.97 mm	97.80 mm	1.35 mm	19° Super Flo. Dish Head. + 1mm Oversize

SUZUKI GSXR 1000 (2005-2008) -BUCKET

F0377	E	24mm	4.46mm	95.7mm	1.7mm	20° Taper Flo. Stock size. Special Alloy.
F0378	E	25mm	4.46mm	95.7mm	1.7mm	20° Taper Flo. + 1mm Oversize. Special Alloy.
F0379	I	30mm	4.48mm	95.6mm	1.7mm	25° Taper Flo. Stock size.
F0380	I	31mm	4.48mm	95.6mm	1.7mm	25° Taper Flo. + 1mm Oversize.

SUZUKI GSXR 1100 (1986-1990) - ADJUST. ROCKERS

F0067	I	30 mm	4.97 mm	135 mm	BLANK	19° Flo-No Groove-No Tip. Special Alloy
F0065	E/I	38 mm	4.97 mm	135 mm	BLANK	19° Flo-No Groove-No Tip. Special Alloy
F0036	E	26 mm	5 mm	85.3 mm	2.8 mm	21° Flo. Oversize
F0037	I	30 mm	5 mm	85.9 mm	2.8 mm	19° Super Flo. Oversize
F0068	I	31.5 mm	5 mm	85.90 mm	2.8 mm	19° Super Flo. Oversize

SUZUKI GS 1100 (1980-1983)

SUZUKI GS 1150 (1984-1986)

F0007	E	24 mm	5.5 mm	85.9 mm	4.1 mm	21° Super Flo. Stock Size
F0008	E	26 mm	5.5 mm	85.9 mm	4.1 mm	21° Super Flo. Oversize
F0328	E	30 mm	5.5 mm	87.52 mm	4.1 mm	19° Top Fuel. Super Alloy
F0005	I	28.5 mm	5.5 mm	86.52 mm	4.1 mm	19° Super Flo. Stock Size
F0006	I	31 mm	5.5 mm	86.52 mm	4.1 mm	19° Flo. Oversize
F0047	I	34 mm	5.5 mm	135 mm	BLANK	19° Super Flo-No Groove-No Tip

SUZUKI GSX 1300R - HAYABUSA - (1999-2000)

F0151	E	27.5 mm	4.96 mm	94.84 mm	1.7 mm	20° Flo Dish Head. Stock size
F0152	E	28.5 mm	4.96 mm	94.84 mm	1.7 mm	20° Flo Dish Head. + 1mm oversize
F0153	I	33 mm	4.98 mm	95.03 mm	1.7 mm	20° Flo Dish Head. Stock size
F0154	I	34 mm	4.98 mm	95.03 mm	1.7 mm	20° Flo Dish Head. + 1mm oversize

YAMAHA YZF 600R6 (1999-2000)

F0155	E	22 mm	3.96 mm	94.09 mm	1.7 mm	25° Flo Flat Head. Stock size
F0156	E	23 mm	3.96 mm	94.09 mm	1.7 mm	25° Flo Flat Head. + 1mm oversize
F0157	I	24.95 mm	3.98 mm	94.25 mm	1.7 mm	20° Flo Dish Head. Stock size
F0158	I	25.95 mm	3.98 mm	94.25 mm	1.7 mm	20° Flo Dish Head. + 1mm oversize

YAMAHA FZR 1000 (1989-1995) - 5 VALVE ENGINE

F0111	I	23.5 mm	4.5 mm	90.5 mm	1.7 mm	18° Super Flo - 1 Valve required. Stock Size
F0112	I	23.55 mm	4.5 mm	92 mm	1.7 mm	18° Super Flo - 2 Valves required. Stock Size
F0114	E	25.05 mm	4.5 mm	90.3 mm	1.7 mm	19° Flo - 2 Valves required. Stock Size
F0063	E	26 mm	4.5 mm	125 mm	BLANK	21° Super Flo-No Groove-No Tip

ROAD RACE AND DRAG RACE MOTORCYCLE MADE TO ORDER APPLICATIONS

The following valves are not stock inventory items. These valves will be made to order.

A nominal labor charge will be added to the cost of the valve. Please contact us for the labor charge.

MOTORCYCLE COMPETITION VALVES

Part#	Type	Head Diam.	Stem Diam.	Overall Length	Tip Length	References
HONDA CBR 600F2 (1991-1994) / HONDA CBR 600F3 (1995-1998)						
F0094	E	22 mm	4 mm	79.30 mm	1 mm	19° Flo Dish Head. Stock Size
F0294	E	22 mm	4 mm	79.30 mm	1 mm	19° Flo Flat Head. For pistons w/o dimples
F0194	E	23 mm	4 mm	79.30 mm	1 mm	19° Flo. Oversize
F0394	E	23 mm	4 mm	79.30 mm	1 mm	19° Flat Head (Kit Valve). Oversize
F0092	I	25.50 mm	4 mm	79.25 mm	1 mm	18° Super Flo Dish Head. Stock Size
F0292	I	25.50 mm	4 mm	79.25 mm	1 mm	18° Super Flo Flat Head. For pistons w/o dimples
F0192	I	26.50 mm	4 mm	79.25 mm	1 mm	18° Super Flo. Oversize
F0392	I	26.5 mm	4 mm	79.25 mm	1 mm	19° Flat Head (Kit Valve). Oversize
HONDA CBR 600RF4 (1999-2000)						
F0115	E	23 mm	3.96 mm	80.85 mm	1 mm	15° Flo Flat Head. Stock size
F0116	E	24 mm	3.96 mm	80.85 mm	1 mm	15° Flo Flat Head. + 1mm oversize
F0117	I	26.5 mm	3.98 mm	88 mm	1 mm	14° Flo Flat Head. Stock size
F0118	I	27.5 mm	3.98 mm	88 mm	1 mm	21° Flo Dish Head. Dble seat. + 1mm oversize
KAWASAKI ZX7R (1996-1999)						
F0147	E	25 mm	4.45 mm	94.56 mm	1.25 mm	12° Flo Flat Head. Stock size
F0148	E	26 mm	4.45 mm	94.56 mm	1.25 mm	12° Flo Flat Head. + 1mm oversize
F0149	I	29 mm	4.47 mm	94.17 mm	1.25 mm	12° Flo Dish Head. Stock size
F0150	I	30 mm	4.47 mm	94.17 mm	1.25 mm	12° Flo Dish Head. + 1mm oversize
KAWASAKI ZX9R (1998-1999)						
F0139	E	26 mm	4.45 mm	93.03 mm	1.25 mm	12° Flo Flat Head. Stock size
F0140	E	27 mm	4.45 mm	93.03 mm	1.25 mm	12° Flo Flat Head. + 1mm oversize
F0141	I	30 mm	4.47 mm	92.44 mm	1.25 mm	12° Flo Dish Head. Stock size
F0142	I	31 mm	4.47 mm	92.44 mm	1.25 mm	12° Flo Dish Head. + 1mm oversize
KAWASAKI ZX10 (1988-1990)						
F0100	E	26 mm	5 mm	88.85 mm	1.25 mm	19° Flo. Stock Size
F0200	E	27 mm	5 mm	88.85 mm	1.25 mm	19° Flo. 1 mm Oversize
F0099	I	30 mm	5 mm	89.20 mm	1.25 mm	18° Super Flo. Stock Size
F0199	I	31 mm	5 mm	89.20 mm	1.25 mm	18° Super Flo. 1 mm Oversize
KAWASAKI ZX11 (1990-1999)						
F0101	E	27 mm	5 mm	88.9 mm	1.25 mm	19° Flo. Stock Size
F0201	E	28 mm	5 mm	88.9 mm	1.25 mm	19° Flo. 1 mm Oversize
F0102	I	31.5 mm	5 mm	89.25 mm	1.25 mm	18° Super Flo. Stock Size
F0202	I	32.5 mm	5 mm	89.25 mm	1.25 mm	18° Super Flo. 1 mm Oversize
SUZUKI GSXR 750 (2000)						
F0273	E	24 mm	3.96 mm	95.67 mm	1.7 mm	19° Flo Dish Head. Stock size
F0274	E	25 mm	3.96 mm	95.67 mm	1.7 mm	19° Flo Dish Head. + 1mm oversize
F0271	I	29 mm	3.98 mm	95.4 mm	1.7 mm	19° Flo Dish Head. Stock size
F0272	I	30 mm	3.98 mm	95.4 mm	1.7 mm	19° Flo Dish Head. + 1mm oversize
SUZUKI GSXR 750 (TITANIUM) - ROAD RACE						
F0088	E	24 mm	4.5 mm	96.4 mm	1.6 mm	15° Flo
F0087	I	29 mm	4.5 mm	96.3 mm	1.6 mm	15° Flo
SUZUKI SV 650 (1999-2002)						
F0297	E	25.5 mm	4.47 mm	86.2 mm	1.7 mm	22° Flo Dish Head. Stock Size
F0298	E	26.5 mm	4.47 mm	86.2 mm	1.7 mm	22° Flo Dish Head. +1mm Oversize
F0295	I	31 mm	4.48 mm	94.8 mm	1.7 mm	20° Flo Dish Head. Stock Size
F0296	I	32 mm	4.48 mm	94.8 mm	1.7 mm	20° Flo Dish Head. +1mm Oversize
SUZUKI GSXR 1000 (2001-2002)						
F0273	E	24 mm	3.96 mm	95.67 mm	1.7 mm	19° Flo Dish Head. Stock Size
F0274	E	25 mm	3.96 mm	95.67 mm	1.7 mm	19° Flo Dish Head. +1mm Oversize
F0271	I	29 mm	3.98 mm	95.4 mm	1.7 mm	19° Flo Dish Head. Stock Size
F0272	I	30 mm	3.98 mm	95.4 mm	1.7 mm	19° Flo Dish Head. +1mm Oversize
YAMAHA YZF 1000R1 (1998-2000) - 5 VALVE ENG.						
F0159	E	24.45 mm	4.46 mm	89.16 mm	1.7 mm	24° Flo Dish Head. Stock size. 2 Valves required
F0160	E	25.45 mm	4.46 mm	89.16 mm	1.7 mm	24° Flo Dish Head. +1mm o/size. 2 Valves required
F0161	I	22.95 mm	3.97 mm	91.94 mm	1.7 mm	14° Flo Dish Head. Stock size. 2 Valves required
F0162	I	23.95 mm	3.97 mm	91.94 mm	1.7 mm	14° Flo Dish Head. +1mm o/size. 2 Valves required
F0163	I	23 mm	3.97 mm	90.65 mm	1.7 mm	14° Flo Dish Head. Stock size. 1 Valve required
F0164	I	24 mm	3.97 mm	90.65 mm	1.7 mm	14° Flo Dish Head. +1mm o/size. 1 Valve required

MOTORCYCLE COMPETITION VALVES - BLANKS

Part#	Type	Head Diam.	Stem Diam.	Overall Length	Tip Length	References
BLANKS 4 - 5 mm ("REQUIRE LASH CAPS OR HARD TIPS")						
F0066	E	23 mm	4 mm	125 mm	BLANK	21° Flo-No Groove-No Tip
F0064	E/I	26.5 mm	4 mm	125 mm	BLANK	21° Flo-No Groove-No Tip
F0232	I	30 mm	4 mm	135 mm	BLANK	21° Super Flo
F0173	E	28.5 mm	4.46 mm	120 mm	BLANK	12° Flo-No Groove-No Tip
F0171	E/I	31 mm	4.48 mm	120 mm	BLANK	12° Taper Flo Bimetallic. Special Alloy
F0172	I	31 mm	4.48 mm	120 mm	BLANK	15° Taper Flo Bimetallic. Special Alloy
F0062	I	34 mm	4.48 mm	125 mm	BLANK	19° Flo-No Groove-No Tip. Special Alloy
F0063	E	26 mm	4.5 mm	125 mm	BLANK	21° Flo-No Groove-No Tip
F0183	E	29 mm	4.95 mm	130 mm	BLANK	12° Taper Flo. Special Alloy
F0337	E	27 mm	4.97 mm	135 mm	BLANK	19° Flo. Special Alloy. Bi-Metallic
F0067	I	30 mm	4.97 mm	135 mm	BLANK	19° Flo-No Groove-No Tip. Special Alloy
F0069	E	34 mm	4.97 mm	140 mm	BLANK	19° Flo. Super Alloy
F0184	I	34 mm	4.97 mm	130 mm	BLANK	12° Flo
F0362	I	36 mm	4.97 mm	135 mm	BLANK	12° Flo. Special Alloy
F0065	E/I	38 mm	4.97 mm	135 mm	BLANK	19° Flo-No Groove-No Tip. Special Alloy
F0338	I	32.1 mm	4.98 mm	135 mm	BLANK	19° Super Flo. Dish Head
F0514	I	35mm	4.98mm	145mm	BLANK	20° Flo. Dish Head. Hardenable Seat
BLANKS 5 - 6 mm ("REQUIRE LASH CAPS OR HARD TIPS")						
F2415P	E	32 mm	5.46mm	145mm	BLANK	25° Taper Flo. Super Alloy
F0242	E	34 mm	5.48 mm	145 mm	BLANK	15° Taper Flo. Flat Head. Special Alloy
F1943P	E	32 mm	5.48 mm	140 mm	BLANK	22° Flo. Super Alloy Turbo Applications
F1459P	E	32 mm	5.48 mm	135 mm	BLANK	22° Flo. Super Alloy
F1457P	I	37 mm	5.48 mm	145 mm	BLANK	20° Super Flo
F0241	I	41 mm	5.48 mm	135 mm	BLANK	14° Flat Head
F0047	I	34 mm	5.5 mm	135 mm	BLANK	19° Super Flo-No Groove-No Tip
F0253	I	42 mm	5.5 mm	135 mm	BLANK	19° Super Flo
F1492P	E	34 mm	5.95 mm	140 mm	BLANK	21° Tulip Flo. Bimetallic Super Alloy
F1942P	E	34 mm	5.95 mm	140 mm	BLANK	21° Flo. Super Alloy Turbo Applications
F0176	E	36 mm	5.95 mm	135 mm	BLANK	21° Flo
F2416P	I	37 mm	5.47 mm	145 mm	BLANK	24° Super Flo. Special Alloy
F0175	E	36 mm	5.96 mm	135 mm	BLANK	21° Super Flo-No Groove-No Tip
F1580P	I	36 mm	5.97 mm	145 mm	BLANK	12° Super Flo-No Groove-No Tip. Special Alloy
F1581P	I	38 mm	5.97 mm	145 mm	BLANK	15° Super Flo-No Groove-No Tip. Special Alloy
F0174	I	42 mm	5.97 mm	135 mm	BLANK	19° Super Flo-No Groove-No Tip
F0293	I	46 mm	5.97 mm	145 mm	BLANK	19° Super Flo. Special Alloy
F1582P	I	46 mm	5.97 mm	145 mm	BLANK	12° Super Flo-No Groove-No Tip
F1996P	E	38 mm	5.975mm	150mm	BLANK	21° Tulip Taper Flo. Dish Head. Super Alloy
BLANKS 6 - 7 mm ("REQUIRE LASH CAPS OR HARD TIPS")						
F0060	I	40 mm	6 mm	145 mm	BLANK	19° Super Flo-No Groove-No Tip
F1595P	E	31 mm	6.02 mm	145 mm	BLANK	25° Flo Special Alloy
F1596P	I	36 mm	6.03 mm	145 mm	BLANK	19° Super Flo
F1455P	E	32.5 mm	6.55 mm	135 mm	BLANK	22° Flo. Super Alloy
F1941P	E	32.5 mm	6.55 mm	140 mm	BLANK	22° Flo. Super Alloy Turbo Applications
F1453P	E	36 mm	6.57 mm	145 mm	BLANK	20° Super Flo
F1438P	I	38 mm	6.58 mm	135 mm	BLANK	20° Super Flo
F1585P	E	34 mm	6.95 mm	145 mm	BLANK	15° Flo-No Groove-No Tip. Special Alloy
F0004	E	32.95 mm	6.97 mm	135 mm	BLANK	22° Flo-No Groove-No Tip. Special Alloy
F0034	E	36 mm	6.97 mm	145 mm	BLANK	22° Flo-No Groove-No Tip. Special Alloy
F0038	E	39 mm	6.97 mm	145 mm	BLANK	22° Tulip Flo-No Groove-No Tip
F1586P	I	39 mm	6.97 mm	145 mm	BLANK	12° Super Flo-No Groove-No Tip. Special Alloy
F0002	I	41.95 mm	6.97 mm	135 mm	BLANK	20° Flo-No Groove-No Tip. Special Alloy
F1419P	E	34.5 mm	6.98 mm	135 mm	BLANK	30° Flo
F1418P	I	40 mm	6.98 mm	135 mm	BLANK	20° Super Flo
F0077	E	1.750	.275	5.710	BLANK	24° Tulip Flo. Special Alloy. Harley Davidson
F0078	I	2.100	.275	5.710	BLANK	24° Tulip Flo. Harley Davidson
BLANKS 7 - 8 mm ("REQUIRE LASH CAPS or HARD TIPS")						
F0345	E	33 mm	7 mm	145 mm	BLANK	22.5° Tulip Flo. Super Alloy
F0346	E	39 mm	7 mm	144 mm	BLANK	22.5° Tulip Flo. Dish Head. Super Alloy
F0303B	E	41 mm	7 mm	117 mm	2.5 mm	25° Flo. Over Size. Triple Groove
F0039	I	46 mm	7 mm	145 mm	BLANK	12° Flo. No Groove. No Tip
F0301B	I	46 mm	7 mm	114.8 mm	2.5 mm	25° Super Flo. Over Size. Triple Groove
F2162P	E	32 mm	7.09 mm	145 mm	BLANK	R. 12mm Flo. Flat Head
F2163P	I	38 mm	7.01 mm	145 mm	BLANK	19° Super Flo. Flat Head
F2376P	I	38mm	7.10mm	145mm	BLANK	19° Super Flo. Flat Head. Special Alloy
F0230	E	41 mm	7.96 mm	135 mm	BLANK	20° Super Flo. DUCATI
F0229	I	47 mm	7.98 mm	135 mm	BLANK	20° Super Flo. DUCATI
F1442P	I	44 mm	8 mm	110 mm	8.5 mm	10°
BLANKS 9 mm ("REQUIRE LASH CAPS or HARD TIPS")						
F2332P	E	47mm	8.96mm	178mm	BLANK	25° Taper Flo. Special Alloy. Porsche
F2363P	E	47mm	8.96mm	178mm	BLANK	25° Flo. Flat Head. Special Alloy. Porsche
F2333P	I	53mm	8.98mm	178mm	BLANK	12° Super Flo. Flat Head. Porsche.
F2364P	I	53mm	8.98mm	178mm	BLANK	18° Flo. Flat Head. Porsche
F2307P	I	56mm	8.98mm	178mm	BLANK	10° Super Flo. Flat Head. Porsche
F2362P	I	56mm	8.98mm	178mm	BLANK	10° Flo. Flat Head. Porsche

BEEHIVE VALVE SPRINGS

Part#	Type/Material/ Application	O.D.	I.D.	Seat Press.	Open Press.	Rate Inch	Coil Bind	Max Net Lift
HARLEY DAVIDSON - TWIN CAM (2005-2008)								
S2019	Single Beehive .PAC Alloy Drag Racing applications	1.080 1.445	.650 1.000	195 lbs @1.810	380 lbs @1.310	370 lbs	1.185	.600
This Spring requires Ferrea Titanium Retainer # E12028 and Ferrea Spring Seat Locator # SL1095 or Factory supplied Seat Locator								
S2020	Single Beehive Ovate. PAC Alloy Nitrided Endurance applications	1.100 1.445	.650 1.000	190 lbs @1.810	380 lbs @1.310	370 lbs	1.165	.610
This Spring requires Ferrea Titanium Retainer # E12028 and Ferrea Spring Seat Locator # SL1095 or Factory supplied Seat Locator								

HARLEY DAVIDSON - MILWAUKEE EIGHT (2016-2019)

S2028	Single Beehive Ovate .PAC Alloy Performance OEM replacement	.940 1.105	.580 .742	80 lbs @ 1.600"	285 lbs @ 1.000"	342 lbs	.950	.600
This Spring requires Ferrea Titanium Retainer # E12044 and Both, Ferrea Spring Seat Locator # SL1171 and Ferrea Hat Seal Spring Seat Locator # SL1172. (Discard OEM Factory supplied seat locator).								

VALVE SPRINGS

Part#	Type/Material/ Application	O.D.	I.D.	Seat Press.	Open Press.	Rate Inch	Coil Bind	Max Net Lift
ARTIC CAT DVX 400 (2004-2008) - QUAD								
S10130	Single Spring - Special Alloy Endurance applications	20.32 mm	14.23 mm	35 lbs @33.45 mm	128 lbs @23.35 mm	234 lbs	21.21 mm	11.45 mm
This Spring requires Ferrea Titanium Retainer # E11103 and Ferrea Spring Seat Locator #SL1112. Discard OEM Spring Seat Locator.								
BUELL XB9 (2002 - 2003)								
S10065	Outer w/Damper Special Alloy Hi-Performance Spring	1.490	1.076	130 lbs @1.700	325 lbs @1.200	390 lbs	1.020	.650
This Spring requires Ferrea Titanium Retainer # E11040 and Factory supplied Spring Seat Locator								
CAN AM 800R - ROTAX TWIN (2005-2012) - ATV - ROCKERS								
S10152	Dual Spring - Endurance Special Alloy	18.23 mm 25.19 mm	13.4 mm 18.23 mm	65 lbs @33.5 mm	175 lbs @23.5 mm	279 lbs	19.2 mm	12.7 mm
This Spring requires either Ferrea Titanium Retainer #E11124 and Ferrea Seat Locator #SL1135.(Discard OEM Factory Spring Seat Locator).								
CAN AM 1000R TWIN - MAVERICK / OUTLANDER / RENEGADE (2013-2014) - ATV - ROCKERS								
S10161	Single Spring Special Alloy Endurance Application	21.50mm	15.10mm	53 lbs @35.65mm	126 lbs @25.65mm	185 lbs	22.1 mm	11.6 mm (EXH) 12.7 mm (INT)
This Spring requires Ferrea Titanium Retainer # E11133 and Ferrea Spring Seat Locator # SL1144. NOTE: Valve seals must be removed to allow Ferrea Spring Seat Locators to properly fit over the OEM stock valve guide.								
CAN AM MAVERICK X3 - DOHC 12 VALVE (2017-2019) - UTV - TURBO								
S10180	Single Spring - Special Alloy Turbo Endurance applications	24.70 mm	18.23 mm	70 lbs @30 mm	140 lbs @20 mm	178 lbs	19.10 mm	10 mm
This Spring requires Ferrea Titanium Retainer # E11148 and BOTH, Ferrea Spring Seat Locator # SL1177 and Factory supplied hat seal spring seat locator.								
HARLEY DAVIDSON EVOLUTION (1984-1998)								
S10052	Dual w/Damper - Chro Silicon Hydraulic & Solid	1.005 1.530	.730 1.110	135 lbs @1.875	395 lbs 1.225	400 lbs	1.160	.650
This Spring requires Ferrea Titanium Retainer #E11029 and Ferrea Spring Seat Locator #SL1024 (Discard OEM Spring Seat Locator)								
S10053	Dual w/Damper Chrome Silicon-Roller	1.025 1.550	.740 1.135	215 lbs @1.950	550 lbs 1.270	460 lbs	1.170	.700
This Spring requires Ferrea Titanium Retainer #E11028 and Ferrea Spring Seat Locator #SL1024 (Discard OEM Spring Seat Locator)								
S10054	Dual w/Damper Chrome Silicon-Roller	1.005 1.440	.725 1.065	175 lbs @1.810	350 lbs @1.260	320 lbs	1.160	.600
This Spring requires Ferrea Titanium Retainer #E11027 and Ferrea Spring Seat Locator #SL1024(Discard OEM Spring Seat Locator)								
HARLEY DAVIDSON - VRSCA V ROD (2002-2003)								
S10096	Dual Spring Special Alloy	.819 1.103	.625 .819	80 lbs @1.338	205 lbs @.945	317 lbs	.790	.550
This Spring requires Ferrea Titanium Retainer # E11041 and Factory supplied Spring Seat Locator								

VALVE SPRINGS

Part#	Type/Material/ Application	O.D.	I.D.	Seat Press.	Open Press.	Rate Inch	Coil Bind	Max Net Lift
-------	-------------------------------	------	------	----------------	----------------	--------------	--------------	-----------------

HONDA CRF 250R (2004-2007) - MOTOCROSS

S10105	Single Spring - Special Alloy Endurance Application (EXHAUST - 2 pieces)	18.10 mm	11.50 mm	50 lbs @39.8mm	165 lbs @29.8mm	292 lbs	27.5 mm	10 mm
--------	--	----------	----------	-------------------	--------------------	---------	---------	-------

This spring requires Ferrea Titanium Retainers #E11071 (EXH) and Ferrea Spring Seat Locators #SL1058 (EXH)
Spring pressures are measured with Ferrea Spring Seat Locator #SL1058 (EXH). (Discard OEM Spring Seat Locator)

S10106	Single Spring - Special Alloy Endurance Application (INTAKE - 2 pieces)	18.50 mm	13.0 mm	40 lbs @35.13mm	95 lbs @25.13mm	139 lbs	23 mm	10 mm
--------	---	----------	---------	--------------------	--------------------	---------	-------	-------

This spring requires Ferrea Titanium Retainers #E11072 (INT) and Ferrea Spring Seat Locators #SL1059 (INT)
Spring pressures are measured with Ferrea Spring Seat Locator #SL1059 (INT). (Discard OEM Spring Seat Locator) TECH NOTE: Ferrea Pro Springs are designed with progressive wound coils. Assemble stacked coils end of spring at the bottom, on top of spring seat locator.

HONDA CRF 250R (2008-2009) - MOTOCROSS

S10105	Single Spring - Special Alloy Endurance Application (EXHAUST - 2 pieces)	18.10 mm	11.50 mm	50 lbs @39.8mm	165 lbs @29.8mm	292 lbs	27.5 mm	10 mm
--------	--	----------	----------	-------------------	--------------------	---------	---------	-------

This spring requires Ferrea Titanium Retainers #E11086 (EXH) and Ferrea Spring Seat Locators #SL1058 (EXH)
Spring pressures are measured with Ferrea Spring Seat Locator #SL1058 (EXH). (Discard OEM Spring Seat Locator)

S10106	Single Spring - Special Alloy Endurance Application (INTAKE - 2 pieces)	18.50 mm	13.0 mm	43 lbs @34.63mm	98 lbs @24.63mm	139 lbs	23 mm	9.5 mm
--------	---	----------	---------	--------------------	--------------------	---------	-------	--------

This spring requires Ferrea Titanium Retainers #E11072 (INT) and Ferrea Spring Seat Locators #SL1059 (INT)
Spring pressures are measured with Ferrea Spring Seat Locator #SL1059 (INT). (Discard OEM Spring Seat Locator) TECH NOTE: Ferrea Pro Springs are designed with progressive wound coils. Assemble stacked coils end of spring at the bottom, on top of spring seat locator.

HONDA CRF 250R (2010-2015) - MOTOCROSS

S10140	Single Spring - Special Alloy Endurance Application (EXHAUST - 2 pieces)	18.10 mm	11.50 mm	50 lbs @41.3mm	161 lbs @31.3mm	281 lbs	30.00 mm	10 mm
--------	--	----------	----------	-------------------	--------------------	---------	----------	-------

This spring requires Ferrea Titanium Retainers #E11114 (EXH) or Ferrea Tool Steel Retainer # E10035 (EXH) and Ferrea Spring Seat Locators #SL1123 (EXH). Spring pressures are measured with Ferrea Spring Seat Locator #SL1123 (EXH). (Discard OEM Spring Seat Locator)

S10139	Single Spring - Special Alloy Endurance Application (INTAKE - 2 pieces)	18.50 mm	13.0 mm	45 lbs @36.5mm	105 lbs @26.5mm	152 lbs	25.4 mm	10 mm
--------	---	----------	---------	-------------------	--------------------	---------	---------	-------

This spring requires Ferrea Titanium Retainers #E11112 (INT) or Ferrea Tool Steel Retainer # E10036 (INT) and Ferrea Spring Seat Locators #SL1122 (INT) Spring pressures are measured with Ferrea Spring Seat Locator #SL1122 (INT). (Discard OEM Spring Seat Locator) TECH NOTE: Ferrea Pro Springs are designed with progressive wound coils. Assemble stacked coils end of spring at the bottom, on top of spring seat locator.

HONDA CRF 250R (2016-2017) - MOTOCROSS

S10171	Single Spring - Special Alloy Endurance Application (EXHAUST - 2 pieces)	18.10 mm	11.50 mm	50 lbs @41.3mm	161 lbs @31.3mm	281 lbs	30.00 mm	10 mm
--------	--	----------	----------	-------------------	--------------------	---------	----------	-------

This spring requires Ferrea Titanium Retainers #E12036 (EXH) and Ferrea Spring Seat Locators #SL1164 (EXH).
Spring pressures are measured with Ferrea Spring Seat Locator #SL1164 (EXH). (Discard OEM Spring Seat Locator)

S10172	Single Spring - Special Alloy Endurance Application (INTAKE - 2 pieces)	18.50 mm	13.0 mm	45 lbs @38 mm	105 lbs @28 mm	152 lbs	27 mm	10 mm
--------	---	----------	---------	------------------	-------------------	---------	-------	-------

This spring requires Ferrea Titanium Retainers #E12037 (INT) and Ferrea Spring Seat Locators #SL1165 (INT).
Spring pressures are measured with Ferrea Spring Seat Locator #SL1165 (INT). (Discard OEM Spring Seat Locator)
TECH NOTE: Ferrea Pro Springs are designed with progressive wound coils. Assemble stacked coils end of spring at the bottom, on top of spring seat locator.

HONDA CRF 250R (2018) - MOTOCROSS

S10175	Single Spring	22.22 mm	15.87 mm					
	PAC Enhanced Alloy Endurance Application INTAKE ASSEMBLY			45 lbs @34.15 mm	140 lbs @24.15 mm	244 lbs	22.27 mm	11.43 mm
	EXHAUST ASSEMBLY			50 lbs @33.7 mm	145 lbs @23.7 mm	244 lbs	22.27 mm	10.80 mm

This Spring requires Ferrea Titanium Retainer #E12040 and Ferrea Spring Seat Locator # SL1168. TECH NOTE: Ferrea Pro Springs are designed with progressive wound coils. Assemble stacked coils end of spring at the bottom, on top of spring seat locator.

VALVE SPRINGS

Part#	Type/Material/ Application	O.D.	I.D.	Seat Press.	Open Press.	Rate Inch	Coil Bind	Max Net Lift
HONDA CRF 450 (2002-2008) - MOTOCROSS								
S10085	Single Spring Special Alloy Endurance Application	21.50 mm	15.10 mm	75 lbs @37 mm	155 lbs @ 27 mm	203 lbs	25 mm	10 mm
This Spring requires Ferrea Titanium Retainers #E11054 (EXH) and #E11055 (INT) and Ferrea Spring Seat Locators #SL1043 (EXH) and #SL1042 (INT) Spring pressures are measured with Ferrea Spring Seat Locator # SL1043 (EXH) (Discard OEM Spring Seat Locator)								
HONDA CRF 450 (2009-2012) - MOTOCROSS								
S10153	Single Spring Special Alloy Endurance Application	21.50 mm	15.10 mm	75 lbs @36 mm	155 lbs @26 mm	203 lbs	24 mm	10 mm
This Spring requires either Ferrea Titanium Retainer #E11126 and Ferrea Seat Locator #SL1137 (EXH) and #SL1138 (INT). Spring pressures measured with Ferrea Spring Seat Locator #SL1137 (EXH). (Discard OEM Factory Spring Seat Locator).								
HONDA CRF 450 (2013-2016) - MOTOCROSS								
S10173	Single Spring Special Alloy Endurance Application INTAKE ASSEMBLY EXHAUST ASSEMBLY	21.5 mm	15.10 mm	55 lbs @35.5 mm 60 lbs @37 mm	130 lbs @25.5 mm 135 lbs @27 mm	190 lbs 190 lbs	22.0 mm 25.5 mm	12 mm 11 mm
This Spring requires Ferrea Titanium Retainer #E12038 and Ferrea Spring Seat Locator (INTAKE) # SL1166 and (EXHAUST) # SL1167. Discard OEM Factory supplied Spring Seat Locator.								
HONDA TRX 450 (2004-2005)								
S10117	Single Spring Special Alloy Endurance Application	21.50 mm	15.10 mm	75 lbs @37 mm	155 lbs @ 27 mm	203 lbs	25 mm	10 mm
This Spring requires Ferrea Titanium Retainers #E11078 (EXH) and #E11055 (INT) and Ferrea Spring Seat Locators #SL1043 (EXH) and #SL1042 (INT) (Discard OEM Spring Seat Locator) Spring pressures are measured with Ferrea Spring Seat Locator # SL1043 (EXH)								
KAWASAKI KLX 400 (2001-2008) - MOTOCROSS								
KAWASAKI KFX 400 (2001-2008) - QUAD								
S10130	Single Spring-Special Alloy Endurance Application	20.32 mm	14.23 mm	35 lbs @33.45 mm	128 lbs @23.35 mm	234 lbs	21.21 mm	11.45 mm
This Spring requires Ferrea Titanium Retainers #E11103 and Ferrea Spring Seat Locator #SL1112 (Discard OEM Spring Seat Locator)								
POLARIS RZR XP 900 (2011-2012)								
S10147	Dual Spring Special Alloy Endurance Application	19.05 mm 25.30 mm	13.95 mm 19.05 mm	70 lbs @34.36 mm	170 lbs @24.36 mm	254 lbs	20.83 mm	12.3 mm
This spring requires Ferrea Titanium Retainer # E11121 and Ferrea Spring Seat Locator # SL1125. (Discard OEM Spring Seat locator).								
POLARIS RZR XP 1000 (2014)								
S10159	Single Spring. Special Alloy Endurance Spring	25.19 mm	18.3 mm	85 lbs @34.3 mm	155 lbs @24.3 mm	178 lbs	21.8 mm	11.5 mm
This spring requires Ferrea Titanium Retainer # E11121 and OEM factory supplied hat style seat/seal spring seat locator. NOTE: Max Net Lift is limited by the OEM factory hat style seat/seal locator height.								
PRO STOCK MOTORCYCLE								
S10063	Dual Spring Special Alloy Maximum Retainer step .075	.890 1.215	.650 .890	150 lbs @1.400	450 lbs @.750	462 lbs	.710	.650
SUZUKI DRZ 400 (2000-2009) - MOTOCROSS / SUZUKI LTZ 400 (2000-2009) - QUAD								
S10130	Single Spring-Special Alloy Endurance Application	20.32 mm	14.23 mm	35 lbs @33.45 mm	128 lbs @23.35 mm	234 lbs	21.21 mm	11.45 mm
This Spring requires Ferrea Titanium Retainer #E11103 and Ferrea Spring Seat Locator #SL1112 (Discard OEM Spring Seat Locator)								
SUZUKI GSX 1300R -HAYABUSA- (1999-2000)								
S10141	Dual Spring-Special Alloy Endurance Application	18.82 mm 25.19 mm	13.84 mm 18.82 mm	65 lbs @37.30 mm	170 lbs @27.30 mm	266 lbs	22.30 mm	14 mm
This Spring requires Ferrea Titanium Retainers #E11111 and Ferrea Spring Seat Locator #SL1124 (Discard OEM Spring Seat Locator)								
YAMAHA YZF450 - (2003-2009) - MOTOCROSS - 5 VALVE ENGINE								
YAMAHA YFZ450 - (2004-2009) - QUAD - 5 VALVE ENGINE								
S10119	Single Spring-Special Alloy Endurance Application	18.30 mm	13.3 mm	38 lbs @29.5 mm	85 lbs @19.5 mm	119 lbs	17.2 mm	11 mm
This Spring requires Ferrea Titanium Retainers #E11090 (EXH), E11091 (INT) and Ferrea Spring Seat Locator #SL1097 (Discard OEM Spring Seat Locator) TECH NOTE: Ferrea Seat Locators must be installed, during assembly, BEFORE VALVE SEALS.								
YAMAHA 700R - GRIZZLY / RAPTOR / RHINO (2006-2009) - 4 VALVE ENGINE								
S10116	Dual Spring Special Alloy Endurance Application	18.82 mm 25.19 mm	13.84 mm 18.82 mm	55 lbs @37 mm	155 lbs @27 mm	253 lbs	21 mm	14.5 mm
This Spring requires Ferrea Titanium Retainers #E11085 and Ferrea Spring Seat Locators #SL1093 (Discard OEM Spring Seat Locator) TECH NOTE: To properly install Spring Seat Locator you must first remove the Valve Stem Seal.								

TITANIUM RETAINERS

Part#	Valve Stem Size	Diam. (A)	Out Step Diam. (B)	Inn Step Diam (C)	References
ARTIC CAT DVX 400 (2004-2008) - QUAD					
E11103	5 mm	20.05 mm	14.48 mm	-	Single Spring-7 deg Pro CNC-Ferrea Racing Springs #S10130 NOTE: MUST USE WITH HONDA CRF 5mm VALVE LOCKS
BUELL XB9 (2002 - 2003)					
E11040	.276	1.440	1.080	-	Single Spring-7 deg Pro CNC-Ferrea Racing Springs #S10065
CAN AM 800R - ROTAX TWIN (2005-2012) - ATV - ROCKERS					
E11124	5mm	22.35mm	18.29mm	10.46mm	Dble Spring-7deg Pro CNC-(8 pieces). Ferrea Racing Springs #S10152 Use Factory OEM Triple Groove Locks
CAN AM 1000R TWIN - MAVERICK / OUTLANDER / RENEGADE (2013-2014) - ATV - ROCKERS					
E11133	5mm	20.06 mm	-	15.24 mm	Single Spring-7 deg Pro CNC Ferrea Racing Spring # S10161
CAN AM MAVERICK X3 - DOHC 12 VALVE (2017-2019) - UTV - TURBO					
E11148	5mm	23 mm	-	18.5 mm	Sggle Spring-7 deg Pro CNC Ferrea Racing Springs #S10180 Use Factory OEM Locks
HARLEY DAVIDSON - EVOLUTION - (1984-1998)					
E11027	ALL	1.440	1.065	.700	Dble Spring-10 deg Pro CNC Ferrea Racing Springs #S10054
E11028	ALL	1.500	1.140	.744	Dble Spring-10 deg Pro CNC Ferrea Racing Springs #S10053
E11029	ALL	1.500	1.115	.725	Dble Spring-10 deg Pro CNC Ferrea Racing Springs #S10052
HARLEY DAVIDSON - TWIN CAM (2005-2008)					
E12028	.275	1.050	.640	-	Beehive Spring - 7 deg Pro CNC Ferrea Racing Springs #S2019 & #S2020 Ferrea Valve Lock # K10090
HARLEY DAVIDSON - VRSCA V ROD (2002-2003)					
E11041	6 mm	26.16 mm	20.83 mm	-	Dble Spring-7 deg Pro CNC-Ferrea Racing Springs #S10096 Use Factory OEM Triple Groove Locks
E11067	6 mm	26.16 mm	20.83 mm	-	Dble Spring-7 deg Pro CNC-Ferrea Racing Springs #S10096 and Ferrea Valve Lock #K10075
HARLEY DAVIDSON - MILWAUKEE EIGHT (2016-2019)					
E12044	.235	.895	-	.575	Beehive Spring-7 deg Pro-CNC Ferrea Racing Springs #S2028 Use Facotry OEM Locks
HONDA CRF 250R (2004-2007) - MOTOCROSS					
E11071	4.97 mm	16.25 mm	11.55 mm	-	EXH (2 pieces) Single Spring-7 deg Pro CNC Ferrea Racing Springs #S10105
E11072	4.98 mm	17.25 mm	13.15 mm	-	INT (2 pieces) Single Spring-7 deg Pro CNC Ferrea Racing Springs #S10106
HONDA CRF 250R (2008-2009) - MOTOCROSS					
E11086	4.47 mm	16.25 mm	11.81 mm	-	EXH (2 pieces). Single Spring-7 deg Pro CNC Ferrea Racing Spring #S10105
E11072	4.98 mm	17.25 mm	13.15 mm	-	INT (2 pieces). Single Spring-7 deg Pro CNC Ferrea Racing Spring #S10106
HONDA CRF 250R (2010-2015) - MOTOCROSS					
E11114	4.5 mm	17.47 mm	11.81 mm	-	EXH (2 pieces). Single Spring-7 deg Pro CNC Ferrea Racing Spring #S10140
E11112	5.0 mm	17.78 mm	13.25 mm	-	INT (2 pieces). Single Spring-7 deg Pro CNC Ferrea Racing Spring #S10139
HONDA CRF 250R (2016-2017) - MOTOCROSS					
E12036	5 mm	17.47 mm	11.81 mm	-	EXH (2 pieces). Single Spring-7 deg Pro CNC Ferrea Racing Spring #S10171
E12037	5 mm	17.78 mm	13.25 mm	-	INT (2 pieces). Single Spring-7 deg Pro CNC Ferrea Racing Spring #S10172
HONDA CRF 250R (2018) - MOTOCROSS					
E12040	5 mm	20.32 mm	16.0 mm	-	Sggle Spring-7deg Pro CNC-(4 pieces) Ferrea Racing Springs #S10175 Use Factory OEM valve locks
HONDA CRF 450 (2002-2008) - MOTOCROSS					
E11054	4.965 mm	20.00 mm	15.14 mm	-	EXH (2 pieces). Single Spring-7 deg Pro CNC- Ferrea Racing Spring # S10085
E11055	5.49 mm	20.00 mm	15.14 mm	-	INT (2 pieces). Single Spring-7 deg Pro CNC- Ferrea Racing Spring # S10085
HONDA CRF 450 (2009-2012) - MOTOCROSS					
E11126	5mm	20 mm	15.14mm	-	Single Spring-7deg Pro CNC-(4 pieces). Ferrea Racing Springs #S10153. Use Factory OEM Valve Locks

TITANIUM RETAINERS

Part#	Valve Stem Size	Diam. (A)	Out Step Diam. (B)	Inn Step Diam (C)	References
HONDA CRF 450 (2013-2016) - MOTOCROSS					
E12038	5 mm	16.25 mm	11.55 mm	-	Sgle Spring-7deg Pro CNC-(4 pieces) Ferrea Racing Springs #S10173 Use Factory OEM valve locks
HONDA TRX 450 (2004-2005)					
E11078	5.49 mm	20.06 mm	15.14 mm	-	EXH (2 pieces). Single Spring-7 deg Pro CNC- Ferrea Racing Spring # S10085
E11055	5.49 mm	20.00 mm	15.14 mm	-	INT (2 pieces). Single Spring-7 deg Pro CNC- Ferrea Racing Spring # S10085
KAWASAKI KLX 400 (2001-2008) - MOTOCROSS / KAWASAKI KFX 400 (2001-2008) - QUAD					
E11103	5 mm	20.05 mm	14.48 mm	-	Single Spring-7 deg Pro CNC-Ferrea Racing Spring # S10130 NOTE: Must use with HONDA CRF 5mm VALVE LOCKS
POLARIS RZR XP 900 - (2011-2012) / POLARIS RZR XP 1000 (2014)					
E11121	5.5 mm	22.86 mm	18.41 mm	13.08 mm	Dble Spring - 7° Pro CNC - (8 pieces) Ferrea Racing Springs # S10147
SUZUKI DRZ 400 (2000-2009) - MOTOCROSS / SUZUKI LTZ 400 (2000-2009) - QUAD					
E11103	5 mm	20.05 mm	14.48 mm	-	Single Spring-7 deg Pro CNC-Ferrea Racing Spring # S10130 NOTE: Must use with HONDA CRF 5mm VALVE LOCKS
SUZUKI GSX 1300R -HAYABUSA- (1999-2000)					
E11111	5 mm	21.97 mm	-	13.34 mm	Dble Sping-7 deg Pro CNC-Ferrea Racing Spring # 10141 Ferrea Valve Lock # K10103
YAMAHA YZF450 - (2003-2009) - MOTOCROSS - 5 VALVE ENGINE					
YAMAHA YZF450 - (2004-2009) -QUAD - 5 VALVE ENGINE					
E11090	5 mm	16.51 mm	-	13.33	EXH (2 pieces). Single Spring-7 deg Pro CNC- Ferrea Racing Spring # S10119
E11091	4.5 mm	16.51 mm	-	13.33	INT (3 pieces). Single Spring-7 deg Pro CNC- Ferrea Racing Spring # S10119
YAMAHA 700R - GRIZZLY / RAPTOR / RHINO (2006-2009) - 4 VALVE ENGINE					
E11085	6 mm	23.11 mm	18.41 mm	13.33 mm	Double Spring - 6 deg Pro CNC retainer Ferea Racing Spring # S10116.

TOOL STEEL RETAINERS

Part#	Valve Stem Size	Diam. (A)	Out Step Diam. (B)	Inn Step Diam (C)	References
HONDA CRF 250R (2010) - MOTOCROSS					
E10035	4.5 mm	17.47 mm	11.81 mm	-	EXH (2 pieces). Single Spring-7 deg Pro CNC Ferrea Racing Spring #S10140
E10036	5.0 mm	17.78 mm	13.25 mm	-	INT (2 pieces). Single Spring-7 deg Pro CNC Ferrea Racing Spring #S10139

STEEL VALVE LOCKS

Part#	Specifications
HARLEY DAVIDSON - EVOLUTION (1984-1998)	
K10009	5/16 Std. "10 Deg."
HARLEY DAVIDSON - TWIN CAMS (2005-2008)	
K10090	0.2754. Single Radial Groove. 7 Deg. Use with Ferrea Titanium Retainer # E12028
HARLEY DAVIDSON - VRSCA V ROD (2002-2003)	
K10075	6 mm. Radial Groove
SUZUKI GSX 1300R - HAYABUSA - (1999-2000)	
K10103	5 mm. Radial Groove. 7 Deg. Use with Ferrea Titanium Retainer # E11111

SPRING SEAT LOCATORS

Part#	Specifications
ARTIC CAT DVX 400 (2004-2008) - QUAD	
SL1112	Required for Ferrea Spring # S10130
CAN AM 800R - ROTAX TWIN (2005-2012) - ATV - ROCKERS	
SL1135	Required for Ferrea Springs #S10152 (8 Pieces)
CAN AM 1000R TWIN - MAVERICK / OUTLANDER / RENEGADE (2013-2014) - ATV - ROCKERS	
SL1144	Required for Ferrea Spring # S10161 (8 pieces) NOTE: Valve seals must be removed to allow Ferrea Spring Seat Locators to properly fit over the OEM stock valve guide.
CAN AM MAVERICK X3 - DOHC 12 VALVE (2017-2019) - UTV - TURBO	
SL1177	Required for Ferrea Springs # S10180 (12 pieces)
HARLEY DAVIDSON - EVOLUTION (1984-1998)	
SL1024	Required for Ferrea Springs #S10052 or S10053 (4 pieces)

SPRING SEAT LOCATORS

Part#	Specifications
HARLEY DAVIDSON - TWIN CAM (2005-2008)	
SL1095	Exhaust & Intake. Required for Ferrea Springs # S2019 & S2020 and Ferrea Titanium Retainer # E12028 Seat Locator and Valve Seal one piece assembly. Valve Seal Viton ruber compound Hi Temp
HARLEY DAVIDSON - MILWAUKEE EIGHT (2016-2019)	
SL1171	Required for Ferrea Springs # S2028 (8 pieces)
SL1172	Required for Ferrea Springs # S2028 (8 pieces)
HONDA CRF 250R (2004-2007) - MOTOCROSS	
SL1058	Exhaust. Required for Ferrea Spring # S10105 and Ferrea Titanium Retainer # E11071.
SL1059	Intake. Required for Ferrea Spring # S10106 and Ferrea Titanium Retainer # E11072.
HONDA CRF 250R (2008-2009) - MOTOCROSS	
SL1058	Exhaust. Required for Ferrea Spring # S10105 and Ferrea Titanium Retainer # E11086
SL1059	Intake. Required for Ferrea Spring # S10106 and Ferrea Titanium Retainer # E11072
HONDA CRF 250R (2010-2015) - MOTOCROSS	
SL1123	Exhaust. Required for Ferrea Spring # S10140 and Ferrea Titanium Retainer # E11114 or Ferrea Tool Steel Retainer # E10035
SL1122	Intake. Required for Ferrea Spring # S10139 and Ferrea Titanium Retainers #E11112 or Ferrea Tool Steel Retainer # E10036
HONDA CRF 250R (2016-2017) - MOTOCROSS	
SL1164	Exhaust (2 pieces). Required for Ferrea Spring # S10171
SL1165	Intake (2 pieces). Required for Ferrea Spring # S10172
HONDA CRF 250R (2018) - MOTOCROSS	
SL1168	Required for Ferrea Springs # S10175 (4 Pieces)
HONDA CRF 450 (2002-2008) - MOTOCROSS	
SL1043	Exhaust. Required for Ferrea Spring # S10085 and Ferrea Titanium Retainer # E11054.
SL1042	Intake. Required for Ferrea Spring # S10085 and Ferrea Titanium Retainer # E11055.
HONDA CRF 450 (2009-2012) - MOTOCROSS	
SL1137	Exhaust. Required for Ferrea Springs #S10153 (2 Pieces).
SL1138	Intake. Required for Ferrea Springs # S10153 (2 Pieces).
HONDA CRF 450 (2013-2016) - MOTOCROSS	
SL1166	Intake (2 pieces). Required for Ferrea Spring # S10173
SL1167	Exhaust (2 pieces). Required for Ferrea Spring # S10173
HONDA TRX 450 (2004-2005)	
SL1043	Exhaust. Required for Ferrea Spring # S10085 and Ferrea Titanium Retainer # E11078.
SL1042	Intake. Required for Ferrea Spring # S10085 and Ferrea Titanium Retainer # E11055.
KAWASAKI KLX 400 (2001-2008) - MOTOCROSS / KAWASAKI KFX 400 (2001-2008) - QUAD	
SL1112	Required for Ferrea Springs # S10130
POLARIS RZR XP 900 - (2011-2012)	
SL1125	Required for Ferrea Springs # S10147 (8 pieces).
SL1130	Required for Ferrea Springs #S10147 (8 Pieces) - HIGH PRESSURE
SUZUKI DRZ 400 (2000-2009) - MOTOCROSS / SUZUKI LTZ 400 (2000-2009) - QUAD	
SL1112	Required for Ferrea Springs # S10130
SUZUKI GSX 1300R -HAYABUSA- (1999-2000)	
SL1124	Required for Ferrea Springs # S10141
YAMAHA YZF 450 - (2003-2009) - MOTOCROSS - 5 VALVE ENGINE	
YAMAHA YZF 450 - (2004-2009) - QUAD - 5 VALVE ENGINE	
SL1097	Required for Ferrea Springs # S10119
YAMAHA 700R - GRIZZLY / RAPTOR / RHINO (2006-2009) - 4 VALVE ENGINE	
SL1093	Required for Ferrea Springs # S10116 (4 pieces)

COPPER BRONZE VALVE GUIDES

Part#	Specifications
HARLEY DAVIDSON - EVOLUTION (1984-1998)	
VG1025	Exhaust .310. OD .562". O/A Length 2.160" - Valve seal .426 (ID)
VG1042	Exhaust .310. OD .563" (+.001 oversize). O/A Length 2.160" - Valve seal .426 (ID)
VG1026	Intake .310. OD .562". O/A Length 2.100" - Valve seal .426 (ID)
VG1043	Intake .310. OD .563" (+.001 oversize). O/A Length 2.100" - Valve seal .426 (ID)
HARLEY DAVIDSON - MILWAUKEE EIGHT (2016-2019)	
VG1111	Exhaust/Intake .235. OD .475". O/A Length 1.650". Use Ferrea Hat Seal Seat Locator #SL1172.

VALVE SEALS

Part#	Specifications
HARLEY DAVIDSON - EVOLUTION (1984-1998)	
VS1004	Exhaust - .310 valve stem. Viton rubber compound. Hi Temp
VS1005	Intake - .310 valve stem. Viton rubber compound



HIGH POWER VALVETRAIN COMPONENTS

2020 APPLICATION GUIDE

VALVE LISTING

(by manufacturer)

FOR CYLINDER HEAD MANUFACTURER

Head Description/Part N#	Valves Type/Size	Titanium	Comp Plus	FERREA VALVES (Class/Part N#)		
				6000 Ser	5000 Ser	Motorcycle
AIR FLOW RESEARCH - CHEVROLET BIG BLOCK(*)						
BIG BLOCK CHEVY	E 1.880 X 5.450	F1327	F1261P	F6157	N/A	
	E 1.940 X 5.450	CUSTOM	F1260P	F6158	N/A	
	I 2.250 X 5.471	CUSTOM	F1232P	F6195	N/A	
AIR FLOW RESEARCH - CHEVROLET SMALL BLOCK(*)						
180 CC SBC STREET	E 1.600 X 4.910	F1346	F1100PQ	F6100	F5005	
180 CC LT1 STREET	I 2.020 X 4.910	F1650	F1115P	F6101	F5002	
190 CC SBC STREET						
190 CC LT1 STREET						
195 CC SBC STREET						
195 CC LT4 STREET						
180 CC 305 STREET	E 1.500 X 4.910	CUSTOM	CUSTOM	F6107	F5004	
	I 1.940 X 4.910	CUSTOM	CUSTOM	F6102	F5001	
210 CC SBC RACE	E 1.600 X 4.960	F1346	F1100PQ	F6100	N/A	
220 CC SBC RACE	I 2.080 X 4.960	F1314	F1121P	F6115	N/A	
227 CC SBC RACE	E 1.600 X 4.960	F1346	F1100PQ	F6100	N/A	
	I 2.100 X 4.960	F1318	F1871P	F6117	N/A	
215 CC RAISED RUNNER	E 1.600 X 5.160	F1341	F1140PQ	F6147	N/A	
	I 2.100 X 5.160	F1358	F1207P	F6152	N/A	
18 DEGREE GM	E 1.625 X 5.560	F1602	F2220P	N/A	N/A	
	I 2.150 X 5.560	F1614	F2259P	N/A	N/A	
AIR FLOW RESEARCH - FORD SMALL BLOCK(*)						
165 CC FORD SB (NON PEDESTAL)	E 1.600 X 4.960	F1346	F1100PQ	F6100	F5005	
	I 1.900 X 4.960	CUSTOM	CUSTOM	F6218	F5072	
165 CC FORD SB (PEDESTAL)	1.600 X 5.075	CUSTOM	CUSTOM	F6183	F5058	
	1.900 X 5.075	CUSTOM	CUSTOM	F6239	F5071	
185CC FORD SB (NON PEDESTAL)	E 1.600 X 4.960	F1346	F1100PQ	F6100	F5005	
	I 2.020 X 4.960	F1650	F1115P	F6101	F5047	
185 CC FORD SB (PEDESTAL)	1.600 X 5.075	CUSTOM	CUSTOM	F6183	F5058	
	I 2.020 X 5.075	CUSTOM	CUSTOM	F6169	F5069	
TALL PORT FORD SB	E 1.600 X 4.960	F1346	F1100PQ	F6100	F5005	
	I 2.100 X 4.960	F1318	F1871P	F6117	F5030	
ALAN JOHNSON						
HARLEY 80" STREET	E 1.615 X 4.531	CUSTOM	N/A	N/A	N/A	F0145
	I 1.850 X 4.444	CUSTOM	N/A	N/A	N/A	F0144
HARLEY BIG BORE	E 1.615 X 4.531	CUSTOM	N/A	N/A	N/A	F0145
	I 1.900 X 4.444	CUSTOM	N/A	N/A	N/A	F0046
HEMI STAGE 1 OPTIONAL EXH 3/8 STEM	E 2.000 X 5.019	F1333	F1506P	N/A	N/A	
	E 2.000 X 5.019	N/A	F1507P	N/A	N/A	
	I 2.375 X 5.610	F1329	N/A	N/A	N/A	
HEMI STAGE 2 OPTIONAL EXH 3/8 STEM	E 1.950 X 5.019	N/A	F1527P	N/A	N/A	
	E 1.950 X 5.019	N/A	F1532P	N/A	N/A	
	I 2.400 X 5.610	F1729	N/A	N/A	N/A	
AJPE 481X ALCOHOL	E 1.910 X 6.500	CUSTOM	N/A	N/A	N/A	
	I 2.400 X 6.635	CUSTOM	N/A	N/A	N/A	
AJPE SBC-12	E 1.580 X 6.050	F1606	F2215P	N/A	N/A	
	I 2.200 X 6.035	CUSTOM	F1879P	N/A	N/A	
AJPE SBE-18	E 1.600 X 5.690	CUSTOM	F2216P	N/A	N/A	
	E 1.625 X 5.690	F1603	F1880P	N/A	N/A	
	I 2.180 X 5.690	CUSTOM	F1881P	N/A	N/A	
	I 2.200 X 5.690	CUSTOM	F1884P	N/A	N/A	
AJPE SBC-23	E 1.525 X 5.690	CUSTOM	F1882P	N/A	N/A	
	I 2.150 X 5.690	CUSTOM	F1883P	N/A	N/A	

NOTE (*): All the valves listed for these applications have 11/32 stem diameter, NOT 8 mm

FOR CYLINDER HEAD MANUFACTURER

Head Description/Part N#	Valves Type/Size	Titanium	Comp Plus	FERREA VALVES (Class/Part N#)		
				6000 Ser	5000 Ser	Motorcycle
ALAN JOHNSON						
AJPE PRO/STOCK	E 1.925 X 6.810 I 2.600 X 7.100	CUSTOM CUSTOM	N/A N/A	N/A N/A	N/A N/A	
OLDS STAGE 1	E 1.900 X 6.000 I 2.375 X 6.600	CUSTOM CUSTOM	N/A N/A	N/A N/A	N/A N/A	
OLDS STAGE 2	E 1.875 X 6.485 I 2.400 X 6.635	CUSTOM CUSTOM	N/A N/A	N/A N/A	N/A N/A	
OLDS STAGE 3 & 4	E 1.850 X 6.485 I 2.400 X 6.635	CUSTOM CUSTOM	N/A N/A	N/A N/A	N/A N/A	
ALL PRO CYLINDER HEADS - CHEVROLET SMALL BLOCK						
AP 220S & SP	E 1.600 X 5.160 I 2.100 X 5.160	F1341 F1358	F1140PQ F1207P	F6147 F6152	N/A N/A	
RR 227 SP - RR 227 SP-W	E 1.600 X 5.300 I 2.125 X 5.300	F1308 F1662	F2218P F1209P	F6160 F6254	N/A N/A	
RR 245 SP-23	E 1.600 X 5.560 I 2.180 X 5.560	F1351 F1365	F1256P F2267P	N/A N/A	N/A N/A	
RR 260 SP-17	E 1.625 X 5.725 I 2.150 X 5.725	CUSTOM CUSTOM	F1873P F1874P	N/A N/A	N/A N/A	
OPTIONAL INT	I 2.180 X 5.725	CUSTOM	F1875P	N/A	N/A	
RR 265 RE-15	E 1.600 X 5.725 I 2.200 X 5.725	CUSTOM CUSTOM	F1872P F1876P	F6187 N/A	N/A N/A	
RR 267 ULTRA 13 - RR 285 RE-13	E 1.625 X 5.950 I 2.200 X 5.950	CUSTOM CUSTOM	F1877P F1878P	N/A N/A	N/A N/A	
RR 292 RE-15	E 1.600 X 5.725 I 2.180 X 5.725	CUSTOM CUSTOM	F1872P F1875P	N/A N/A	N/A N/A	
BRAD ANDERSON						
HARLEY STREET	E 1.625 X 4.531 I 1.940 X 4.444	F0045 F0044	N/A N/A	N/A N/A	N/A N/A	
HEMI STAGE 1	E 2.000 X 5.019 I 2.375 X 5.610	F1333 F1329	F1506P N/A	N/A N/A	N/A N/A	
HEMI LATE MODEL	E 1.900 X 5.019 I 2.400 X 5.610	N/A F1729P	F1531P N/A	N/A N/A	N/A N/A	
HEMI STAGE 5 - ALCOHOL FAT HEAD	E 1.950 X 6.040 I 2.425 X 6.400	F1637 F1692	N/A N/A	N/A N/A	N/A N/A	
BRODIX - CHEVROLET BIG BLOCK						
BB-1 OEFI	E 1.880 X 5.425 I 2.250 X 5.271	F1327 CUSTOM	F1201P F1212P	F6157 F6129	F5035 F5031	
BB-1 - STS-BB-1 - BB-2 BB-2 PLUS - STS-BB-2 PLUS	E 1.880 X 5.425 I 2.250 X 5.271 I 2.250 X 5.350	1327P CUSTOM F1330	F1201P F1212P F1223P	F6157 F6129 N/A	F5035 F5031 N/A	
BB-2X - BB-2Xtra - BP BB-2Xtra BB-3 - BB-4	E 1.880 X 5.425 I 2.300 X 5.471	F1327 F1331	F1201P F1219P	F6157 F6131	F5035 F5033	
BB-3Xtra; BP BB-3Xtra "O and O332"	E 1.880 X 5.500 I 2.300 X 5.625	F1747 CUSTOM	F1206P F1234P			
Optional INT for "O 351 and O365"-STS BB-4Xtra	I 2.350 X 5.625 E 1.880 X 5.500 I 2.350 X 5.560	CUSTOM F1747 F1694	F2264P F1206P F2264P			
BB-5	E 1.900 X 5.450 I 2.300 X 5.525	F1327 F1684	F1267P F1224P	N/A N/A	N/A N/A	
OPTIONAL INT	I 2.300 X 5.625	CUSTOM	F1234P	N/A	N/A	
STS BB4Xtra - BB-5 OPTIONAL	E 1.940 X 5.450 I 2.300 X 5.625	CUSTOM CUSTOM	F1260P F1234P	N/A N/A	N/A N/A	
BIG DUKE	E 1.900 X 6.500 I 2.400 X 6.650	CUSTOM CUSTOM	N/A N/A	N/A N/A	N/A N/A	

FOR CYLINDER HEAD MANUFACTURER

Head Description/Part N#	Valves Type/Size	Titanium	Comp Plus	FERREA VALVES (Class/Part N#)		
				6000 Ser	5000 Ser	Motorcycle
BRODIX - CHEVROLET BIG BLOCK						
EB 420	E 1.900 X 6.600 I 2.375 X 6.900	F1629 F1685	N/A N/A	N/A N/A		N/A N/A
EB 498	E 1.900 X 6.600 I 2.375 -X 6.900	F1629 F1685	N/A N/A	N/A N/A		N/A N/A
EB 510 - EB 598	E 1.900 X 6.600 I 2.425 X 6.900	F1629 F1687	N/A N/A	N/A N/A		N/A N/A
EB 650 - EB 700	E 1.920 X 6.600 I 2.475 X 6.900	F1631 F1690 (1)	N/A N/A	N/A N/A		N/A N/A
(1) requires head diam.modification						
EB 800	E 1.940 X 6.600 I 2.500 X 6.900	F1634 F1690	N/A N/A	N/A N/A		N/A N/A
JESSE JAMES SERIES JJ294, JJ270	E 1.880 X 5.425 I 2.250 X 5.271	F1327 CUSTOM	F1201P F1212P	F6157 F6129		F5035 F5031
RACE-RITE SERIES RR BB-R, RR BB-0	E 1.880 X 5.425 I 2.250 X 5.271	F1327 CUSTOM	F1201P F1212P	F6157 F6129		F5035 F5031
BRODIX - SPEC HEADS CHEVY FORD MOPAR						
SP CH, SP FO	E 1.600 X 4.960 I 2.080 X 4.960	F1346 F1314	F1100PQ F1121P	F6100 F6115		F5046 F5021
SP MO	E 1.600 X 5.060 I 2.080 X 5.060	F1302 F1350	F1148PQ F1147P	F6202 F6203		N/A N/A
BRODIX - CHEVROLET SMALL BLOCK						
CARB LEGAL ST SMOKEY YUNIK (WP SY WT-1)	E 1.600 X 4.960 I 2.020 X 4.960	F1346 F1650	F1100PQ F1115P	F6100 F6101		F5046 F5047
8 STD FSH (DRAGON SLAYER) - 10 STD OR SP - 11 STD OR SP - TRACK I STD - IMCA SPEC HEAD - CHEVY SPEC HEAD - 8 PRO STS T1 215 - KC T1 227	E 1.600 X 4.960 I 2.080 X 4.960	F1346 F1314	F1100PQ F1121P	F6100 F6115		F5046 F5021
TRACK1X	E 1.600 X 4.960 I 2.100 X 4.960	F1346 F1318	F1100PQ F1871P	F6100 F6117		F5046 N/A
8 - 8PRO - 1 - 11	E 1.600 X 4.960 I 2.080 X 4.960	F1346 F1314	F1100PQ F1121P	F6100 F6115		F5046 F5021
10 RI - 10 X	1E .600 X 5.160 I 2.100 X 5.160 I 2.125 X 5.160	F1341 F1358 F1357	F1140PQ F1207P F1127P	F6147 F6152 F6154		N/A N/A N/A
10 X	E 1.600 X 5.160 I 2.125 X 5.160	F1341 F1357	F1140PQ F1127P	F6147 F6154		N/A N/A
11 X - 11x 11 SP X KC 11 SP X	E 1.600 X 5.060 I 2.080 X 5.060 I 2.100 X 5.060	F1302 F1350 F1319	F1148PQ F1147P F2266P	F6202 F6203 F6256		N/A N/A N/A
JESSE JAMES SIGNATURE SERIES JJ180 JJ200 JJ210 CNC Ported	E 1.600 X 4.960 I 2.020 X 4.960 I 2.055 X 4.960 I 2.080 X 4.960	F1346 F1650 F1349 F1314	F1100PQ F1115P F1111P F1121P	F6100 F6101 F6105 F6115		F5046 F5047 F5003 F5021
IK SERIES IK180 IK200 KC IK 210	E 1.600 X 4.960 I 2.020 X 4.960 I 2.020 X 4.960 I 2.080 X 4.960	F1346 F1650 F1650 F1314	F1100PQ F1115P F1115P F1121P	F6100 F6101 F6101 F6115		F5046 F5047 F5047 F5021
12 (15° VALVE ANGLE) 18 STD OR SPD	E 1.600 X 5.300 I 2.150 X 5.300	F1308 F1665	F1149P F1220P	F6160 F6166		N/A N/A
RACE-RITE SERIES RR180 RR200	E 1.600 X 4.960 I 2.020 X 4.960 I 2.055 X 4.960	F1346 F1650 F1349	F1100PQ F1115P F1111P	F6100 F6101 F6105	F5046 F5047 F5003	

FOR CYLINDER HEAD MANUFACTURER

Head Description/Part N#	Valves Type/Size	Titanium	Comp Plus	FERREA VALVES (Class/Part N#)		
				6000 Ser	5000 Ser	Motorcycle
BRODIX - CHEVROLET SMALL BLOCK						
WP-12 SP RI	E 1.600 X 5.460	F1344	F2202P	N/A	N/A	
	I 2.125 X 5.450	F1663	F2257P	N/A	N/A	
WP-12 SP B WP-18 SP TD	E 1.600 X 5.460	F1344	F2202P	N/A	N/A	
	I 2.150 X 5.450	F1359	F1186P	N/A	N/A	
WP 12X12 B-275	E 1.600 X 5.560	F1351	F1256P	N/A	N/A	
	I 2.150 X 5.560	F1614	F2259P	N/A	N/A	
WP 12X12 B-285, B-296	E 1.600 X 5.560	F1365	F2267P	N/A	N/A	
	I 2.180 X 5.560	F1365	F2267P	N/A	N/A	
WP 12X12 SP RP	E 1.600 X 6.090	F1606	F2215P	N/A	N/A	
	I 2.200 X 6.090	CUSTOM	F1879P	N/A	N/A	
12 SP WB MC WP	E 1.600 X 5.460	F1344	F2202P	N/A	N/A	
	I 2.200 X 5.450	F1667	F2260P	N/A	N/A	
KC 13 STD	E 1.625 X 5.560	F1602	F1257P	N/A	N/A	
	I 2.180 X 5.560	F1365	F2267P	N/A	N/A	
WP 15 SP, WP 15 STD	E 2.180 X 5.850	CUSTOM	CUSTOM	N/A	N/A	
	I 1.625 X 5.850	CUSTOM	CUSTOM	N/A	N/A	
18 STD OR SPD 18 STD X, 18 SP X, STS18 STD X STS 18 SP X	E 1.600 X 5.300	F1308	F1149P	F6160	N/A	
	I 2.150 X 5.300	F1665	F1220P	F6166	N/A	
WP-18 SP C WELD TECH HUT 1.2 KC 18 SP C, 18 STD C	E 1.600 X 5.560	F1351	F1256P	N/A	N/A	
	I 2.180 X 5.560	F1365	F2267P	N/A	N/A	
WP-18 SP C WELD TECH HUT 921 WP-18 SP C WELD TECH HUT 1	E 1.625 X 5.560	F1602	F1257P	N/A	N/A	
	I 2.150 X 5.560	F1614	F2259P	N/A	N/A	
WP-18 SP C WELD TECH HUT 1.1	E 1.625 X 5.560	F1602	F1257P	N/A	N/A	
	I 2.180 X 5.560	F1365	F2267P	N/A	N/A	
CANTED VALVES (CVSP)	E 1.600 X 6.090	F1606	F2215P	N/A	N/A	
	I 2.250 X 6.200	F1669	F2262P	N/A	N/A	
BRODIX - CHRYSLER						
BI (CHRY 440)	E 1.780 X 5.400	CUSTOM	F1275P	N/A	N/A	
	I 2.300 X 5.375	CUSTOM	N/A	F6141	N/A	
BI BS (CHRY 440)	E 1.810 X 5.300	CUSTOM	F1266P	N/A	N/A	
	I 2.200 X 5.300	F1666	F1229P	N/A	N/A	
BI BA - IMCA SPEC MOPAR	E 1.600 X 5.060	F1302	F1148PQ	F6202	N/A	
	I 2.080 X 5.060	F1350	F1147P	F6203	N/A	
BI TS (PRO STOCK) - BI BA MC	E CUSTOM	CUSTOM	CUSTOM	N/A	N/A	
	I CUSTOM	CUSTOM	CUSTOM	N/A	N/A	
BRODIX - FORD						
BF SERIES 200-202 BF 200 BF 201-202	E 1.600 X 5.690	CUSTOM	F2216P	N/A	N/A	
	I 2.125 X 5.725	CUSTOM	F1874P	N/A	N/A	
	I 2.180 X 5.725	CUSTOM	F1875P	N/A	N/A	
BF 300-301	E 1.600 X 5.160	F1341	F1140PQ	F6147	N/A	
	I 2.125 X 5.300	F1662	F1209P	F6254	N/A	
TRACK I STD (TI STD F) - IMCA SPEC FORD	E 1.600 X 4.960	F1346	F1100PQ	F6100	F5025	
	I 2.080 X 4.960	F1314	F1121P	F6115	F5021	
NEAL FORD HEAD (BF 200)	E 1.600 X 5.640	CUSTOM	CUSTOM	N/A	N/A	
	I 2.125 X 5.740	CUSTOM	CUSTOM	N/A	N/A	
ST 5.0 , ST5.0 R	E 1.600 X 4.960	F1346	F1100PQ	F6100	F5025	
	I 1.940 X 4.960	CUSTOM	CUSTOM	F6102	F5001	
KC ST 5.0 R	I 2.020 X 4.960	F1650	F1115P	F6101	F5002	

FOR CYLINDER HEAD MANUFACTURER

Head Description/Part N#	Valves Type/Size	Titanium	Comp Plus	FERREA VALVES (Class/Part N#)		
				6000 Ser	5000 Ser	Motorcycle
CHRYSLER HEMI 99 NHRA PRO-STOCK						
4876883 - 4.900 BORE NHRA	E 1.900 X 6.800	CUSTOM	N/A	N/A	N/A	N/A
5007135 - 5.000 BORE IHRA	I 2.550 x 6.900	CUSTOM	N/A	N/A	N/A	N/A
5007178 - PROMOD						
DART IRON EAGLE - CHEVROLET BIG BLOCK						
308CC	E 1.880 X 5.425	F1327	F1201P	F6157	N/A	N/A
	I 2.250 X 5.471	CUSTOM	F1232P	F6195	N/A	N/A
345CC	E 1.880 X 5.425	F1327	F1201P	F6157	N/A	N/A
	I 2.300 X 5.471	CUSTOM	F1219P	F6131	N/A	N/A
DART IRON EAGLE - CHEVROLET SMALL BLOCK						
180CC & 200 CC	E 1.600 X 4.960	F1346	F1100PQ	F6100	F5005	F5005
	I 2.020 X 4.960	F1650	F1115P	F6101	F5002	F5002
215 CC - PRO 1 215 CC	E 1.600 X 4.960	F1346	F1100PQ	F6100	F5005	F5005
	I 2.050 X 4.960	F1349	F1111P	F6105	F5003	F5003
230 CC	E 1.625 X 4.960	F1347	F1101P	F6143	N/A	N/A
	I 2.080 X 4.960	F1314	F1121P	F6115	N/A	N/A
PRO 1 200 CC	E 1.600 X 4.960	F1346	F1100PQ	F6100	F5005	F5002
	I 2.020 X 4.960	F1650	F1115P	F6101	F5002	F5002
PRO 1 230 CC	E 1.625 X 4.960	F1347	F1101P	F6143	N/A	N/A
	I 2.080 X 4.960	F1314	F1121P	F6115	N/A	N/A
DART PRO 1 - CHEVROLET BIG BLOCK						
310 CC & 325 CC	E 1.880 X 5.425	F1327	F1201P	F6157	N/A	N/A
	I 2.250 X 5.471	CUSTOM	F1232P	F6195	N/A	N/A
345	E 1.880 X 5.425	F1327	F1201P	F6157	N/A	N/A
	I 2.300 X 5.471	CUSTOM	F1219P	F6131	N/A	N/A
DART RACE SERIES - CHEVROLET BIG BLOCK						
DART 265, 308, 320	E 1.880 X 5.425	F1327	F1201P	F6157	N/A	N/A
	I 2.250 X 5.471	CUSTOM	F1232P	F6195	N/A	N/A
DART 360	E 1.900 X 5.425	F1327	F1267	F6186	N/A	N/A
	I 2.300 X 5.471	CUSTOM	F1219P	F6131	N/A	N/A
DART BIG M	E 1.880 X 5.425	F1327	F1201P	N/A	N/A	N/A
	I 2.350 X 5.625	CUSTOM	F2264P	N/A	N/A	N/A
DART BIG CHIEF	E 1.900 X 6.450	F1639	F1263P	N/A	N/A	N/A
	I 2.400 X 6.600	F1323	F1265P	N/A	N/A	N/A
DART RACE SERIES - CHEVROLET SMALL BLOCK						
DART 220	E 1.625 X 5.060	F1303	F1108P	F6205	N/A	N/A
	I 2.100 X 5.060	F1319	F2266P	F6256	N/A	N/A
RAISED RUNNER -23	E 1.625 X 5.160	F1340	F1128P	F6148	N/A	N/A
	I 2.125 X 5.160	F1357	F1127P	F6154	N/A	N/A
DART-18	E 1.625 X 5.560	F1602	F2220P	N/A	N/A	N/A
	I 2.180 X 5.560	F1365	F2267P	N/A	N/A	N/A
DART - CHRYSLER						
DART HEMI T/F F/C	E 1.900 X 5.020	CUSTOM	F1531P	N/A	N/A	N/A
	I 2.400 X 5.610	F1729	N/A	N/A	N/A	N/A
EDELBROCK - CHEVROLET BIG BLOCK						
PERFORMER RPM - 6045-6046	E 1.880 X 5.425	F1327	F1201P	F6157	N/A	N/A
	6047-6048-6049-6054-6055	I 2.190 X 5.300	CUSTOM	F1211P	F6139	N/A
EDELBROCK - CHEVROLET BIG BLOCK (CNC)						
VICTOR JR-6040-6041	E 1.900 X 5.450	F1327	F1270P	N/A	N/A	N/A
	OVAL PORT 6042-6043	I 2.250 X 5.300	F1330	F1212P	N/A	N/A
VICTOR CNC 7765-7760	E 1.900 X 5.450	F1327	F1270P	N/A	N/A	N/A
	I 2.300 X 5.625	CUSTOM	F1234	N/A	N/A	N/A

FOR CYLINDER HEAD MANUFACTURER

Head Description/Part N#	Valves Type/Size	Titanium	Comp Plus	FERREA VALVES (Class/Part N#)		
				6000 Ser	5000 Ser	Motorcycle
EDELBRÖCK - CHEVROLET SMALL BLOCK						
PERFORMER RPM - 6061-6063	E 1.600 X 4.960	F1346	F1100PQ	F6100	F5005	
6088-6071-6073-6089	I 2.020 X 4.960	F1650	F1115P	F6101	F5002	
PERFORMER SBC - 6065-6075-6090						
PERFORMER CENTERBOLT - 6084-6085						
CENTERBOLT - CORVETTE 6086-6087						
VICTOR JR-23 - 7763-7764-7761-7762	E 1.600 X 5.160 I 2.080 X 5.160	F1341 F1356	F1140PQ F1139P	F6147 F6164	N/A N/A	
VICTOR-23 HIGH PORT - 6120-6122-6124	E 1.625 X 5.300 I 2.100 X 5.300	F1371 F1657	F2219P F1208P	F6194 F6257	N/A N/A	
VICTOR 18 HIGH PORT	E 1.625 X 5.560 I 2.125 X 5.560	F1602 F1363	F2220P CUSTOM	N/A N/A	N/A N/A	
OPTIONAL INT	I 2.180 X 5.560	F1365	F2267P	N/A	N/A	
EDELBRÖCK - CHRYSLER						
PERFORMER - 6076-6077-6017-6019	E 1.600 X 5.010 I 2.020 X 5.010	F1302 F1651	F1102P F1118P	F6104 F6103	F5025 F5027	
EDELBRÖCK - FORD 460						
PERFORMER RPM 460	E 1.760 X 5.060	CUSTOM	F1437P	F6258	F5145	
68-71 460 - 6067-6069	I 2.190 X 5.300	F1666	F1211P	F6139	F5037	
72-87 460 - 6066-6068						
EDELBRÖCK - FORD FE						
PERFORMER FE 390-428 - 6007-6008	E 1.650 X 5.435 I 2.090 X 5.450	CUSTOM CUSTOM	CUSTOM CUSTOM	F6212 F6210	N/A N/A	
PERFORMER FE 427 - 6007-6008	E 1.750 X 5.435 I 2.190 X 5.450	CUSTOM CUSTOM	CUSTOM CUSTOM	F6216 F6215	N/A N/A	
EDELBRÖCK - FORD SMALL BLOCK						
PERFORMER - 6021-6022-6031-6032	E 1.600 X 4.960 I 1.900 X 4.960	F1346 CUSTOM	F1100PQ CUSTOM	F6100 F6218	F5005 F5072	
PERFORMER - 6024-6025-6026-6027-6034-6035	E 1.600 X 4.960 I 2.020 X 4.960	F1346 F1650	F1100PQ F1115P	F6100 F6101	F5005 F5002	
PERFORMER 5.0/5.8L - 6028-6036-6037	E 1.600 X 5.075 I 1.900 X 5.075	CUSTOM CUSTOM	CUSTOM CUSTOM	F6183 F6239	F5058 F5071	
PERFORMER 5.0/5.8L - 6029-6038-6039	E 1.600 X 5.075 I 2.020 X 5.075	CUSTOM CUSTOM	CUSTOM CUSTOM	F6183 F6169	F5058 F5069	
VICTOR-JR - 7716-7717-7718-7719	E 1.600 X 5.060 I 2.050 X 5.060	F1302 F1652	F1187P F2252P	F6202 F6207	N/A N/A	
VICTOR-JR - 7721	E 1.625 X 5.450 I 2.125 X 5.450	F1342 F1663	F1178P F2257P	N/A N/A	N/A N/A	
VICTOR CNC	E 1.650 X 5.450 I 2.100 X 5.450	F1348 F1658	F1142P F2255P	N/A N/A	N/A N/A	
EDELBRÖCK - OLDSMOBILE						
PERFORMER RPM OLDS - 6051-6052	E 1.680 X 4.780 I 2.072 X 4.756	CUSTOM CUSTOM	CUSTOM CUSTOM	CUSTOM CUSTOM	CUSTOM CUSTOM	
EDELBRÖCK - PONTIAC						
PERFORMER RPM - 6056-6057-6058-6059	E 1.660 X 5.110 E 1.770 X 5.110 I 1.110 X 5.095	CUSTOM CUSTOM CUSTOM	CUSTOM CUSTOM CUSTOM	F6259 F6176 F6174	CUSTOM F5144 F5143	
PERFORMER RPM - 6058-6059	E 1.660 X 5.230 E 1.770 X 5.230 I 2.110 X 5.213	CUSTOM CUSTOM CUSTOM	CUSTOM CUSTOM CUSTOM	F6177 F6178 F6175	F5064 F5063 F5066	

FOR CYLINDER HEAD MANUFACTURER

Head Description/Part N#	Valves Type/Size	Titanium	Comp Plus	FERREA VALVES (Class/Part N#)		
				6000 Ser	5000 Ser	Motorcycle
FORD RACING 429-460						
FORD 429/460 COBRA-JET M6049-A429-B429-C429	E 1.760 X 5.060 I 2.190 X 5.300	CUSTOM F1666	F1437P F1211P	F6258 F6139	F5145 F5037	
SPORTSMAN C-460 - M6049-C460	E 1.900 X 6.240 I 2.450 X 6.300	F1628 F1688	F1264 F1236	N/A N/A	N/A N/A	
FORD NHRA PRO/STK E460	E 1.880 X CUSTOM I 2.450 X CUSTOM	CUSTOM CUSTOM	N/A N/A	N/A N/A	N/A N/A	
429 FORD RACING HEMI M6049-B441	E CUSTOM I CUSTOM	CUSTOM CUSTOM	N/A N/A	N/A N/A	N/A N/A	
FORD RACING - SMALL BLOCK						
GT-40 P M6049-P303	E 1.480 X 5.075 I 1.840 X 5.075	CUSTOM CUSTOM	CUSTOM CUSTOM	F6260 F6122	CUSTOM F5029	
GT-40 M6049-M50	E 1.480 X 5.075 I 1.780 X 5.075	CUSTOM CUSTOM	CUSTOM CUSTOM	F6260 F6261	CUSTOM CUSTOM	
GT-40X TURBO SWIRL - M6049-X302-X303-X304- X305-Y302-Y303	E 1.540 X 5.075 I 1.940 X 5.075	CUSTOM CUSTOM	CUSTOM CUSTOM	F6123 F6170	F5028 F5059	
SPORTSMAN N-351 - M6049-N351	E 1.600 X 5.160 I 2.020 X 5.160	F1341 CUSTOM	F1140PQ F2251P	F6147 F6206	F5068 F5067	
YATES FORD SB - M6049-C3-C3L-C35	E 1.600 X 5.160 I 2.100 X 5.285	F1341 F1656	F1140PQ F1208P	F6147 F6155	N/A N/A	
YATES HIGH PORT SB - M6049-SCI	E 1.625 X 5.565 I 2.180 X 5.685	F1602 CUSTOM	F2220P F1881P	N/A N/A	N/A N/A	
YATES HIGH PORT SB - M6049-C3H	E 1.600 X 5.260 I 2.125 X 5.450	F1600 F1663	F2218P F2257	N/A N/A	N/A N/A	
INDY CYLINDER HEAD						
440-SR	E 1.810 X 5.370 I 2.190 X 5.344	CUSTOM F1666	F1885P F1226P	F6188 F6189	N/A N/A	
440-1 & C	E 1.810 X 5.370 I 2.190 X 5.344	CUSTOM F1666	F1885P F1226P	F6188 F6189	N/A N/A	
OPTIONAL INT	I 2.250 X 5.344	F1330	F1223P	F6190	N/A	
572-13	E 1.880 X 5.522 I 2.300 X 5.494	F1377 F1684	F1206P F1219P	N/A N/A	N/A N/A	
OPTIONAL INT	I 2.350 X 5.494	F1694	F1225P	N/A	N/A	
600-13	E 1.940 X 5.880 I 2.400 X 5.850	CUSTOM CUSTOM	F1886P CUSTOM	N/A N/A	N/A N/A	
OPTIONAL INT	I 2.450 X 5.850	CUSTOM	CUSTOM	N/A	N/A	
LEGEND HEMI	E 1.900 X 5.019	CUSTOM	F1523P	N/A	N/A	
OPTIONAL EXH	E 1.940 X 5.019	CUSTOM	F1521P	N/A	N/A	
OPTIONAL EXH	E 2.000 X 5.019	CUSTOM	CUSTOM	N/A	N/A	
	I 2.250 X 5.850	CUSTOM	F1887P	N/A	N/A	
OPTIONAL INT	I 2.400 X 5.850	CUSTOM	CUSTOM	N/A	N/A	
MOPAR 318-360						
W9 ALUMINUM 318-360	E 1.625 X 5.560	F1602	F2220P	N/A	N/A	
P5007066-P5007065-P5007179	I 2.150 X 5.560	F1614	F2259P	N/A	N/A	
P5007061 (CNC)-P5007063 (CNC)						
P5007064 (CNC) (*)	I 2.180 X 5.560 (*)	F1365	F2267P	N/A	N/A	
P5007062 (CNC) (*)						
"A" ENGINE 318-360 (CAST IRON)	E 1.600 X 4.970	CUSTOM	CUSTOM	F6244	N/A	
P452969-P5249768-P5249459	I 1.880 X 4.980	CUSTOM	CUSTOM	F6247	N/A	
P5249574-P4876330-P4836179	E 1.600 X 4.970	CUSTOM	CUSTOM	F6244	N/A	
P4876180-	I 2.020 X 4.980	CUSTOM	CUSTOM	F6249	N/A	
ALUMINUM COMMANDO P4876785						
P5249573	E 1.625 X 4.970	CUSTOM	CUSTOM	F6245	N/A	
	I 1.920 X 4.980	CUSTOM	CUSTOM	F6248	N/A	

FOR CYLINDER HEAD MANUFACTURER

Head Description/Part N#	Valves Type/Size	Titanium	Comp Plus	FERREA VALVES (Class/Part N#)		
				6000 Ser	5000 Ser	Motorcycle
MOPAR 318-360						
P4876891	E 1.500 X 4.970	CUSTOM	CUSTOM	F6243	N/A	
	I 1.780 X 4.980	CUSTOM	CUSTOM	F6246	N/A	
ALUMINUM MAGNUM 3.9 & 5.9 P4876624 5/16 stem	E 1.625 X 4.930	CUSTOM	CUSTOM	F6251	N/A	
	I 1.920 X 4.910	CUSTOM	CUSTOM	F6252	N/A	
MAGNUM CAST IRON 3.9 & 5.9 P4876256-P5007086	E 1.625 X 4.930	CUSTOM	CUSTOM	F6251	N/A	
	I 1.920 X 4.910	CUSTOM	CUSTOM	F6252	N/A	
P4876257	E 1.625 X 4.930	CUSTOM	CUSTOM	F6251	N/A	
	I 1.970 X 4.910	CUSTOM	CUSTOM	F6253	N/A	
P4529353	E 36.8 X 114.3	CUSTOM	CUSTOM	N/A	N/A	
	I 44 X 114.3	CUSTOM	CUSTOM	N/A	N/A	
W8 ALUMINUM- P4876281 NASCAR - P4876783 NHRA P4876697 (CNC)	E 1.625 X 5.560	F1602	F2220P	N/A	N/A	
	I 2.180 X 5.560	F1365	F2267P	N/A	N/A	
W5 ALUMINUM - P5249002-P5249435 OPTIONAL EXH	E 1.600 X 5.300	F1308	F1149P	F6160	N/A	
	E 1.625 X 5.300	F1371	F2219P	F6194	N/A	
	I 2.020 X 5.300	CUSTOM	CUSTOM	CUSTOM	N/A	
	I 2.080 X 5.300	F1654	F1238P	F6263	N/A	
	I 2.125 X 5.300	F1662	F1209P	F6254	N/A	
	I 2.150 X 5.300	F1665	F1220P	F6166	N/A	
W2 CAST IRON - P4529994 STD VAL	E 1.600 X 5.075	CUSTOM	CUSTOM	F6173	F5051	
	I 2.020 X 5.050	CUSTOM	CUSTOM	F6172	F5050	
W2 CAST IRON - P452995 LONG VAL	E 1.600 X 5.300	CUSTOM	CUSTOM	N/A	N/A	
	I 2.020 X 5.300	CUSTOM	CUSTOM	N/A	N/A	
RACE W2	E 1.600 X 5.300	CUSTOM	CUSTOM	N/A	N/A	
	E 1.625 X 5.300	CUSTOM	CUSTOM	N/A	N/A	
P4529446 - P5249769 - P5249770 - P4876336 - P5007089	I 2.020 X 5.300	CUSTOM	CUSTOM	N/A	N/A	
	I 2.080 X 5.300	CUSTOM	CUSTOM	N/A	N/A	
	I 2.125 X 5.300	CUSTOM	CUSTOM	N/A	N/A	
MOPAR 383-440						
B/RB STAGE V P4529993 - P5249112	E 1.810 X 4.910	CUSTOM	CUSTOM	F6192	F5053	
	I 2.140 X 4.875	CUSTOM	CUSTOM	F6217	F5052	
ALUMINUM 383/440 - P4876311	E 1.810 X 4.910	CUSTOM	CUSTOM	F6192	F5053	
	I 2.140 X 4.875	CUSTOM	CUSTOM	F6217	F5052	
MAX WEDGE B/RB - P4529996 STAGE II P4529997 STAGE III	E 1.880 X 4.910	CUSTOM	CUSTOM	F6250	F5073	
	I 2.080 X 4.875	CUSTOM	CUSTOM	CUSTOM	F5054	
MAX WEDGE B/RB - BIG VAL STAGE III P52498524	E 1.810 X 4.910	CUSTOM	CUSTOM	F6192	F5053	
	I 2.140 X 4.875	CUSTOM	CUSTOM	F6217	F5052	
B-1 ALUMINUM (B/RB) - P4349600	E CUSTOM	CUSTOM	CUSTOM	N/A	N/A	
	I CUSTOM	CUSTOM	CUSTOM	N/A	N/A	
B/RB STAGE VI - P4529335- P4876819-P5249579- P4879819-P4876991-P4876186	E 1.810 X 4.910	CUSTOM	CUSTOM	F6192	F5053	
	I 2.140 X 4.875	CUSTOM	CUSTOM	F6217	F5052	
B/RB STAGE VI - P4876187 (CNC)- P4876382 (CNC)- P4876383 (CNC)	E 1.810 X 4.910	CUSTOM	CUSTOM	F6192	N/A	
	I 2.180 X 4.875	CUSTOM	CUSTOM	F6191	N/A	

FOR CYLINDER HEAD MANUFACTURER

Head Description/Part N#	Valves Type/Size	Titanium	Comp Plus	FERREA VALVES (Class/Part N#)		
				6000 Ser	5000 Ser	Motorcycle
MOPAR - HEMI 426						
426 CAST IRON HEMI P4529898 - P5249525 - P5249524	E 1.940 X 4.910 I 2.250 X 5.472	CUSTOM CUSTOM	F1521P F1500P	N/A N/A	N/A N/A	N/A N/A
426 ALUMINUM HEAD P4529336 - P4876857 - P4876355 (CNC)	E 1.940 X 4.910 I 2.250 X 5.472	CUSTOM CUSTOM	F1521P F1500P	N/A N/A	N/A N/A	N/A N/A
426 BIG VALVE - P4876873	E 1.940 X 4.910 I 2.350 X 5.472	CUSTOM CUSTOM	F1521P F1895P	N/A N/A	N/A N/A	N/A N/A
MOPAR 4 CYLINDER						
2.2/2.5 SOHC - P4529104	E 36.15 X 112.2 I 41.6 X 112.2	CUSTOM CUSTOM	CUSTOM CUSTOM	N/A N/A	N/A N/A	N/A N/A
PRO ACTION ALUMINUM 14° HEADS - CHEVROLET SMALL BLOCK						
14° 11460030	CUSTOM CUSTOM	CUSTOM CUSTOM	CUSTOM CUSTOM	N/A N/A	N/A N/A	N/A N/A
14° 11462254	E 1.625 X 5.560 I 2.150 X 5.560	F1602 F1614	F2220P F2259P	N/A N/A	N/A N/A	N/A N/A
14° 11462265 - 14° 11462265DN	E 1.625 X 5.560 I 2.180 X 5.560	F1602 F1365	F2220P F2267P	N/A N/A	N/A N/A	N/A N/A
14° 11462285	E 1.625 X 5.560 I 2.250 X 5.625	F1602 CUSTOM	F2220P F1239P	N/A N/A	N/A N/A	N/A N/A
14° 11462285DN	E 1.625 X 5.560 I 2.200 X 5.560	F1602 F1365	F2220P F2261P	N/A N/A	N/A N/A	N/A N/A
14° 11462585DN	E 1.625 X 5.560 I 2.250 X 5.625	F1602 CUSTOM	F2220P F1239P	N/A N/A	N/A N/A	N/A N/A
PRO ACTION IRON - CHEVROLET SMALL BLOCK HEADS						
23° 22300000	E 1.600 X 5.460 I 2.080 X 5.460	F1344 CUSTOM	F2203P CUSTOM	N/A N/A	N/A N/A	N/A N/A
23° 22362022	E 1.600 X 5.460 I 2.080 X 5.460	F1344 CUSTOM	F2203P CUSTOM	N/A N/A	N/A N/A	N/A N/A
23° 22362256	E 1.625 X 5.460 I 2.125 X 5.460	F1342 F1663	F2203P F2257P	N/A N/A	N/A N/A	N/A N/A
14° 21460030	E 1.625 X 5.560 I 2.125 X 5.560	F1602 F1363	F2220P CUSTOM	N/A N/A	N/A N/A	N/A N/A
14° 21462254	E 1.625 X 5.560 I 2.150 X 5.560	F1602 F1614	F2220P F2259P	N/A N/A	N/A N/A	N/A N/A
14° 21462265	E 1.625 X 5.560 I 2.180 X 5.560	F1602 F1365	F2220P F2267P	N/A N/A	N/A N/A	N/A N/A
14° 21465854	E 1.625 X 5.560 I 2.250 X 5.625	F1602 CUSTOM	F2220P F1239P	N/A N/A	N/A N/A	N/A N/A
TRICK FLOW ALUMINUM HEAD - CHEVROLET BIG BLOCK						
BBC	E 1.880 X 5.425 E 1.900 X 5.425 I 2.250 X 5.471 I 2.300 X 5.471	F1327 F1327 CUSTOM CUSTOM	F1201P F1267P F1232P F1219P	F6157 F6186 F6195 F6131	N/A N/A N/A N/A	N/A N/A N/A N/A
TRICK FLOW ALUMINUM HEAD - CHEVROLET SMALL BLOCK						
TWISTED WEDGE G-2 TWISTED WEDGE 23°	E 1.600 X 4.960 I 2.020 X 4.960	F1346 F1650	F1100PQ F1115P	F6100 F6101	F5046 F5047	
TWISTED WEDGE 23° BIG PORT	E 1.600 X 5.010 E 1.600 X 5.060 I 2.055 X 5.010 I 2.080 X 5.060	F1302 F1302 F1652 F1652	F1102P F1187P F1112P F1147P	F6104 F6202 F6114 F6203	F5025 N/A F5022 N/A	

FOR CYLINDER HEAD MANUFACTURER

Head Description/Part N#	Valves Type/Size	Titanium	Comp Plus	FERREA VALVES (Class/Part N#)		
				6000 Ser	5000 Ser	Motorcycle
TRICK FLOW ALUMINUM HEAD - CHEVROLET SMALL BLOCK						
18° SBC	E 1.625 X 5.560	F1602	F2220P	N/A	N/A	
	I 2.150 X 5.560	F1614	F2259P	N/A	N/A	
TRICK FLOW ALUMINUM HEAD - FORD 429-460						
A 460 BBF	E 1.940 X 5.700	F1633	CUSTOM	F6180	N/A	
	I 2.350 X 5.755	F1334	CUSTOM	F6168	N/A	
CJ 429 BBF	E 1.760 X 5.058	CUSTOM	F1437P	F6258	F5145	
	I 2.250 X 5.271	CUSTOM	F1212P	F6129	F5031	
TRICK FLOW ALUMINUM HEAD - FORD SMALL BLOCK						
SBF TWISTED WEDGE	E 1.600 X 4.960	F1346	F1100PQ	F6100	F5046	
	I 2.020 X 4.960	F1650	F1115P	F6101	F5047	
R SERIES SBF	E 1.600 X 5.300	F1308	F2218P	F6160	N/A	
	I 2.080 X 5.300	F1654	F1238P	F6263	N/A	
WORLD PRODUCTS - CHEVROLET BIG BLOCK						
MERLIN STREET/HI PERF	E 1.880 X 5.400	CUSTOM	F2101P	F6125	F5111	
	I 2.190 X 5.271	CUSTOM	F2111P	F6126	F5108	
310 CC REC IRON 3003B						
310 CC REC ALUM 2003B						
MERLIN VR MARINE SPECIAL & SPORTSMAN PORTED	E 1.880 X 5.450	F1327	F1261P	N/A	N/A	
	I 2.250 X 5.350	F1330	F1212P	F6129	N/A	
OVAL PORT IRON 3074MS						
310 CC RET IRON 3072MS						
345 RET IRON 3073MS						
310 CC RET ALUM 2072MS	I 2.250 X 5.471	CUSTOM	F1232P	F6195	N/A	
345 REC ALUM 3073MS						
MERLIN VR RACER SPECIAL & SPORTSMAN PORTED	E 1.880 X 5.425	F1327	F1261P	F6157	N/A	
	I 2.250 X 5.350	F1330	F1212P	F6129	N/A	
OVAL PORT IRON 3004RS						
310 REC IRON 3062RS						
345 REC IRON 3063RS						
310 REC ALUM 2026RS	I 2.250 X 5.471	CUSTOM	F1232P	F6195	N/A	
345 REC ALUM 2063RS						
WORLD PRODUCTS - CHEVROLET SMALL BLOCK						
S/R STOCK REPLACEMENT	E 1.500 X 4.910	CUSTOM	CUSTOM	F6107	F5004	
	I 1.940 X 4.910	CUSTOM	CUSTOM	F6111	F5001	
4360B - 4361B - 4364B - 4365B						
S/R TORQUER	E 1.600 X 4.910	F1346	F1100PQ	F6100	F5005	
	I 2.020 X 4.910	F1650	F1115P	F6101	F5002	
4266B - 4267B - 4277B						
S/R TORQUER 305	E 1.500 X 4.910	CUSTOM	CUSTOM	F6107	F5004	
	I 1.940 X 4.910	CUSTOM	CUSTOM	F6111	F5001	
4265B - 4275B						
SPORTSMAN II CAST IRON	E 1.600 X 4.910	F1346	F1100PQ	F6100	F5005	
	I 2.020 X 4.910	F1650	F1115P	F6101	F5002	
1115B - 1125B - 1215B - 1225B - 1226B						
SPORTSMAN II ALUMINUM	E 1.600 X 4.910	F1346	F1100PQ	F6100	F5005	
	I 2.020 X 4.910	F1650	F1115P	F6101	F5002	
2115B - 2125B - 2215B - 2225B						
SPORTSMAN II CAST IRON RACER SPECIAL & SPORTSMAN PORTED	E 1.600 X 4.910	F1346	F1100PQ	F6100	F5005	
	I 2.055 X 4.910	F1349	F1111P	F6105	F5003	
1115RS - 1125RS - 1215RS - 1225RS - 1226RS	I 2.080 X 4.910	F1314	F1121P	F6115	F5021	
SPORTSMAN II RACER SPECIAL & SPORTSMAN PORTED (ALUMINUM)	E 1.600 X 4.960	F1346	F1100PQ	F6100	F5005	
2115RS - 2125RS - 2215RS - 2225RS	I 2.055 X 4.960	F1349	F1111P	F6105	F5003	
	I 2.080 X 4.960	F1314	F1121P	F6115	F5021	

FOR CYLINDER HEAD MANUFACTURER

Head Description/Part N#	Valves Type/Size	Titanium	Comp Plus	FERREA VALVES (Class/Part N#)		
				6000 Ser	5000 Ser	Motorcycle
WORLD PRODUCTS - CHEVROLET SMALL BLOCK						
MOTOWN RACE SBC	E 1.600 X 5.010	F1302	F1102P	F6104	F5025	
215 CC IRON 0141503	I 2.080 X 5.010	F1350	F1114P	F6116	F5023	
215 CC ALUMINUM 024150						
WORLD PRODUCTS - CHRYSLER 440						
MERLIN CHRYSLER	E 1.810 X 5.369	CUSTOM	CUSTOM	F6188	N/A	
TORQUER 440 2604 PRO 440	I 2.190 X 5.344	CUSTOM	CUSTOM	F6189	N/A	
WORLD PRODUCTS - FORD SMALL BLOCK						
WINDSOR	E 1.600 X 4.960	F1346	F1100PQ	F6100	F5046	
IRON 5302 - ALUM 2302	I 2.020 X 4.960	F1650	F1115P	F6101	F5047	
WINDSOR JR	E 1.600 X 4.960	F1350	F1100PQ	F6100	F5105	
IRON 5303 - ALUM 52303	I 1.940 X 4.960	CUSTOM	CUSTOM	F6111	F5101	
WORLD PRODUCTS - FORD V-6						
2.9 L V6 FORD	E 1.419 X CUSTOM	CUSTOM	CUSTOM	CUSTOM	CUSTOM	
IRON 052900B	I 1.657 X CUSTOM	CUSTOM	CUSTOM	CUSTOM	CUSTOM	

TERMS & Conditions

ORDERS: By Telephone (954) 733-2505 - Monday - Friday 8:30 A.M. to 5:30 P.M. Eastern Time
Toll Free (888) 733-2505 - Monday - Friday 8:30 A.M. to 5:30 P.M. Eastern Time
By Fax (954) 735-2179 - 24 hours a day / 7 days a week
E-mail ferrea@ferrea.com

PRICES: There are available discounts for quantity purchases and approved accounts. Ferrea Racing Components (Horacio O. Ferrea N.A.D., Inc.) reserves the right to decide the qualifications, requirements and the final approval for discounts. Prices are subject to change without notice.

PAYMENT: Cash, Cashier's Check or Money Order via UPS-COD. Company Checks only to approved accounts. We also accept major credit cards and electronic wire transfer, A Service Charge of 1-1/2% (18% per annum) will be added to all past due accounts. Also, a service charge will be applied to all returned checks. If the seller requires the service of an attorney, whether legal action be brought or not, in the event of any default, the buyer agrees to pay all costs of collection including, but not limited to, court costs and attorney fees.

SHIPPING: We use major carriers for shipping (UPS, FedEx, etc.) with freight and other delivery charges (COD, insurance, etc.) collect.

SPECIAL: All special orders must be paid in full, in advance when ordered. The sales of special orders are final and no items may be returned.

RETURNS: Must be authorized and include a copy of the Invoice. No returns accepted after 30 days from the Invoice date. All merchandise returned is subject to a 15% restocking charge.

CUSTOM MADE: Racing valves not in stock can be custom made within days. Check with us for pricing and lead time. Any custom-machined parts made under customer specifications are non-returnable items and the sale is final on these products.

WARRANTY DISCLAIMER: Our racing products are sold without warranty of any kind due to the unusual stress placed on these racing components and because we have no control over how they are used. All implied warranties including all warranties of merchantability or fitness for a particular purpose and other obligations or liabilities are hereby disclaimed. No representations have been made to the buyer regarding our products including, but not limited to, any representation as to their quality or performance. The sole obligation of Ferrea Racing Components (Horacio O. Ferrea N.A.D., Inc.) shall be limited only to the products to be found defective, in either workmanship or material, after the inspection performed by our company. This Limited Warranty applies only to the original purchaser of the product and only covers the replacement or repair of the product at Ferrea's election.

The company shall not be responsible for any damage caused by defects or failure of these parts. The company shall not be responsible for any consequential damage arising from any cause whatsoever, nor for labor, transportation or any other related incurred costs due to the replacement or repair of the defective products.

WARNING: All the parts are sold for racing purposes and may be installed on vehicles (cars, motorcycles, boats, etc.) used solely in sanctioned off-highway events. The installation of these parts may cause the vehicles to be unable to be lawfully used on public highways, and the purchaser assumes all risk and expenses thereof. In our catalogs we use brand names for the sole purpose of identification for vehicles, engines, cylinder heads, etc. No other intention is implied in the use of these brand names. Every possible effort has been made to insure the accuracy of the information listed in this catalog. However, we are not responsible for any damage caused by misapplication or typographical errors.





2600 NW 55th Ct. Ste 230 • Ft.Lauderdale, FL 33309
Ph: 954.733.2505 • Toll Free: 888.733.2505 • Fax: 954.735.2179 • Email: ferrea@ferrea.com

www.ferrea.com