

MICRO INVERTER



WVC-700(Life) USER MANUAL

..... Green Energy
..... Smart Inverter **Expert**

IoT Monitoring Platform Smart mobile "core" life

- CO-2 induced environmental analysis
- Daily and total energy generation in kWh
- Actual DC input voltage, current and power
- Actual AC output voltage, current and power
- Inverter temperature
- Historical (daily, weekly, monthly) power curve
- Power losses due to weather induced effects
- Optional limitation of power output
- Online switch for the inverter start stop

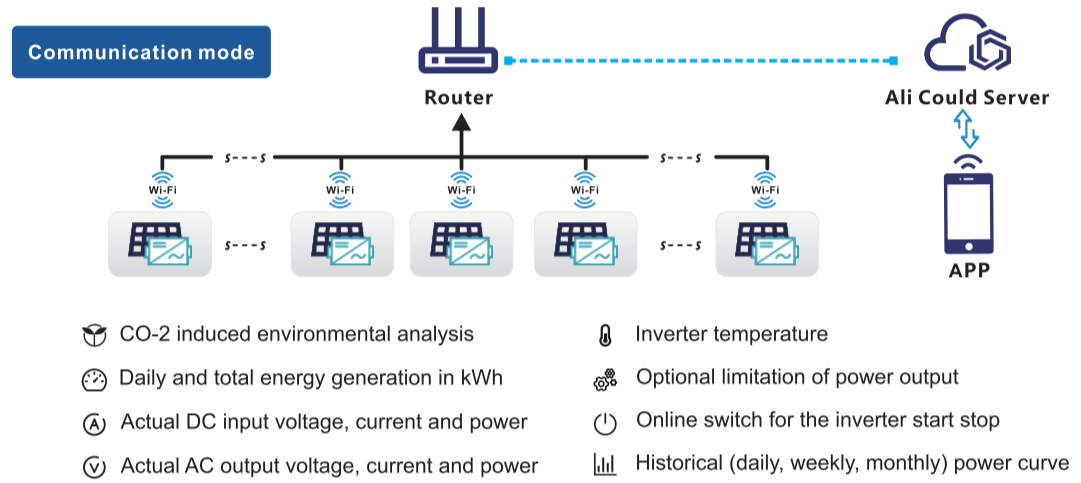

model	WVC-700	
Recommend use panels	2*430Watt	
Output voltage mode	120/230V Auto switch	
PV Open circuit voltage	33-60VDC	
Operating voltage range	22-60V	
Starting voltage range	22-60V	
short-circuit current	2*16A	
Maximum working current	2*14A	

Output parameters	@120V	@230V
Output peak power	700Watt	700Watt
Rated output power	680Watt	680Watt
Output current	5.9A	3.05A
AC voltage range	85-160VAC	180-265VAC
AC frequency range	48-51Hz/58-61Hz	48-51Hz/58-61Hz
Power factor	>95%	>95%
Number of branch connections.	6PCS (Single)	12PCS (Single)

Output efficiency	@120V	@230V
Static MPPT efficiency	99.5%	99.5%
Max output efficiency	95%	95%
Loss of power at night	<0.5W	<0.5W
Total current harmonics	<5%	<5%

Appearance and technical features

Temperature range	-20°C to +50°C	
Size (L×W×H)	283mm×200mm×41.6mm	
Net amount	1.46kg	
Waterproof grade	Ip65 NEMA3R	
Heat dissipation mode	Self-cooling	
Communication mode	Wi-Fi	
Power transmission mode	Reverse transmission, Load priority	
monitoring system	APP	
Electromagnetic Detection	EN61000-6-1:2007 EN6100-6-3:2007 +A1:2011+AC:2012	
Power Grid standard	EN50549-1, EN 50549-2, NBR 16149:2013, UL1741	
Power grid detection	IEC/EN 62109-1, IEC/EN 62109-2, IEC 62116, IEEE 1547	
Certificate	CE , CEC, ETL , INMETRO	

Packing weight

Specifications	Each (Packing)	Box (5PCS)
weight	2.2KG	11.5KG
Size	342×240×115mm	440×380×260mm

Detailed



System diagram

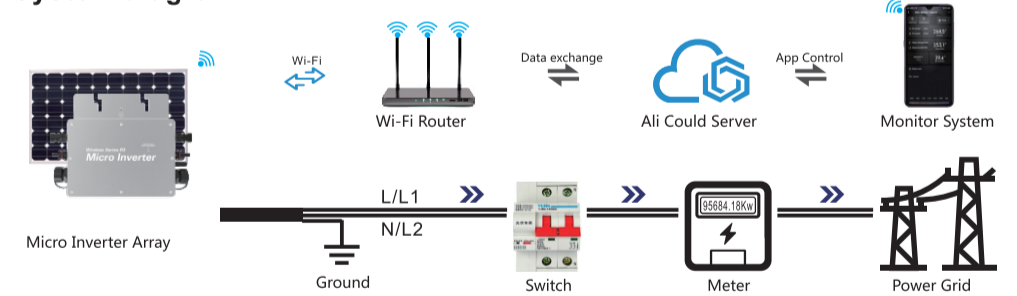

With N wire connection (Single phase 120/230V)

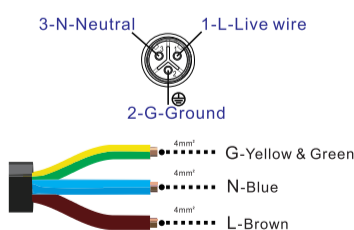

No N wire connection (Single phase 120V)

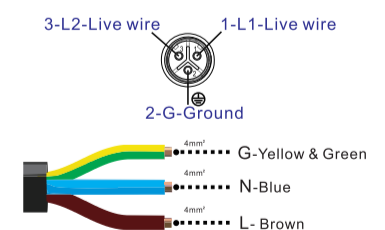

Note: You can purchase a professionally customized AC bus with a T-type connector. Use this AC bus as the AC bus for each branch. Connect it hand in hand to form a modular micro-inverter branch wiring system.



When the inverter is not started/shutdown and has been connected to the grid, the status of the LED indicators is as follows

- 1) When the inverter is not working ----- Red light is always on
- 2) When the inverter is in working state ----- Blue light flashes (MPPT is locked to a long light state)



When the inverter is not started/shutdown and is not connected to the grid, the LED indicator status is as follows

- 1) When the inverter is not working ----- Red light flashes
- 2) When the inverter is in working state ----- Blue light flashes (MPPT is locked in a long light state), and the red light flashes once every three seconds

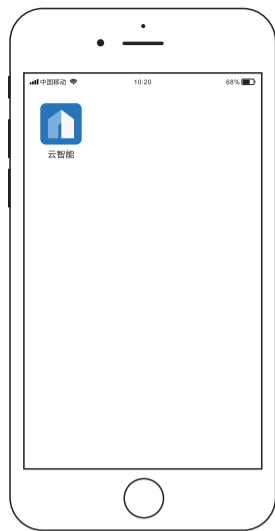

DOWNLOAD Cloud Intelligence APP

Please use the QR code to scan and install the "Cloud Intelligence" client application, System version: Android 5.0, IOS 9 and above



Note

Please strictly observe the following installation conditions

- Connect the communication antenna on the inverter;
- Install the inverter in a place where the Wifi signal is well covered;
- The connected Wi-Fi network needs to be in 2.4G communication mode;
- If the WiFi signal cannot effectively cover the inverter, an additional WiFi signal booster can be installed;
- Turn on the Bluetooth of the mobile phone;



Features

Smart APP can realize real-time data transmission with the cooperation of Alibaba Cloud IoT. Through graphs and graphic displays in time, users can understand the operation of the power station. The user can monitor the operation and adjust the output power function of the system.

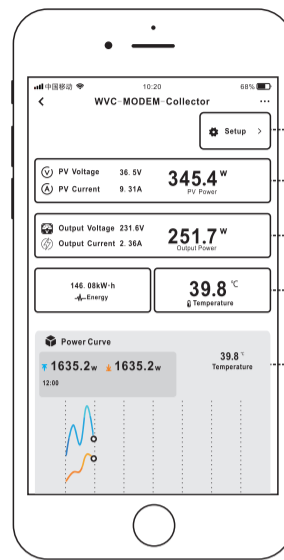

- Setup
- PV Input
- AC Output
- Temperature
- Data query

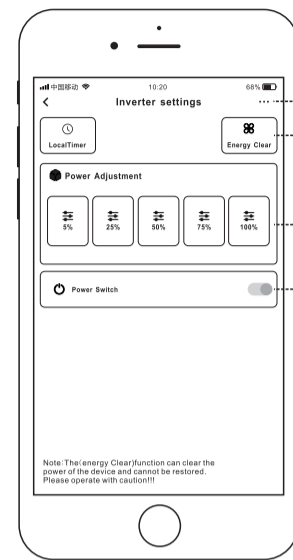

- Attributes
- Energy Clear
- Power Output
- Remote switch

Cloud Intelligence APP



INTELLIGENT IoT MONITORING MODEM
 Number of data collectors per Modem
 Built-in WiFi IoT data terminal
 Can be used on any smart device (Android/iOS)

- CO-2 induced environmental analysis
- Daily and total energy generation in kWh
- Actual DC input voltage, current and power
- Actual AC output voltage, current and power
- Inverter temperature
- Historical (daily, weekly, monthly) power curve
- Power losses due to weather induced effects
- Optional limitation of power output
- Online switch for the inverter start stop

Micro inverter Use Manual(Life)

Bluetooth Mode

Setp 1

Turn on the Bluetooth of the mobile phone, click the "+" icon to add the device;



Click to add

Setp 2

When the inverter appears on the automatic discovery page, click the "+" sign



Click to add

Setp 3

Select WiFi signal, enter the Wi-Fi password; click Next

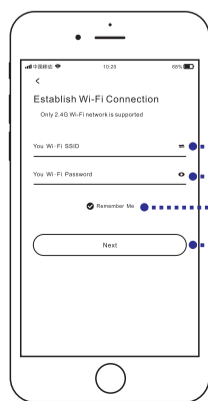

- Enter Wifi Password
- Save Password
- Next Step

Setp 4

The system will enter the network configuration state

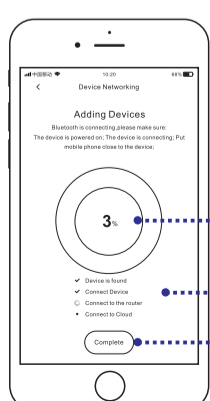

- Network progress
- Progress project
- Network completed

Wi-Fi Mode

Setp 1

Bluetooth distribution network fails, you can click to scan the QR code to operate

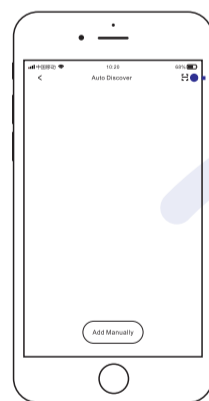

Click to add

Setp 2

Scan the QR code on the inverter to activate network operation

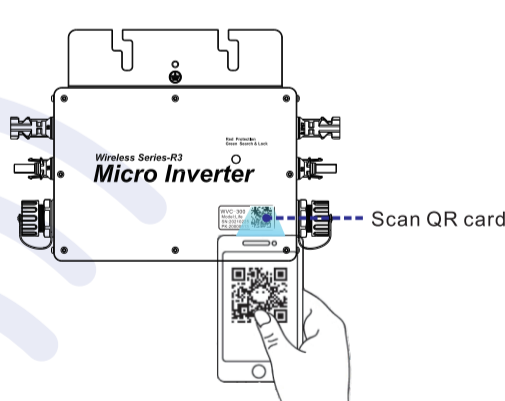

Scan QR card

Setp 3

Select WiFi signal, enter the Wi-Fi password; click Next

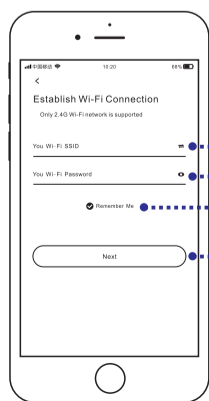

- Enter Wifi Password
- Save Password
- Next Step

Setp 4

The system will enter the network configuration state

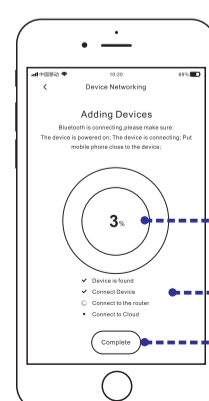

- Network progress
- Progress project
- Network completed