

ASTEDIO



nicoline

Descrizione modello / Model Description

Dimensioni / Dimensions

Composizioni consigliate / Recommended compositions

nicoline.it

ITALY - C.da Parchi Calia sn Z.I. - 70022 Altamura - BA - Telefono: +39 080 3101487

UNITED STATES - Nicoline Salotti Inc. po box 38783 - Greensboro - NC 27438 - Phone: +1 (336) 259 9881

SINGAPORE - 23 Genting Road #06-01 - Chevalier House Singapore 349481 - Telefono: +65 8168 3354

Descrizione

Caratteristiche standard

- Struttura in multistrato, massello di abete e molleggio seduta con cinghie elastiche.
- Imbottiture in poliuretano espanso ecologico a cellula aperta con densità differenziate.
- Cuscini di schienale in fibra "Extra soft".
- Rivestimento in pelle o tessuto con cuscini di seduta, spalliera e braccioli sfoderabili.
- Solo per il mercato ITALIA il rivestimento in tessuto è completamente sfoderabile.
- Elementi Cod.1421 - 1422 - 1671 - 1672 - 2341 - 2342 - 3031 - 3032 - 9507 con ripiano in marmo bianco Carrara (Cod.CA).
- Piede in metallo Canna di fucile (Cod.50).
- Cucitura Cod.01 + Cod.03 per rivestimento in pelle.
- Cucitura Cod.03 per rivestimento in tessuto.
- Inserimento letto non possibile.
- Lato componibile rifinito.

Caratteristiche optional su richiesta senza maggiorazione

- Disponibile con cucitura a contrasto, per la scelta del colore fare riferimento ai codici del campionario pelli.

Caratteristiche optional su richiesta con maggiorazione

- Per il multi rivestimento il prezzo va incrementato del 7%. Per maggiori dettagli fare riferimento al paragrafo "NOTE" posto nelle prime pagine del listino.
- Elementi Cod.1421 - 1422 - 1671 - 1672 - 2341 - 2342 - 3031 - 3032 - 9507 con ripiano in marmo Emperador (Cod.EM), Nero Marquina (Cod.NM).

Note

- I disegni grafici che riportano l'asterisco (*) sono sempre con lato rifinito e anche agganciabili agli elementi componibili
- Non è possibile applicare altre cuciture.
- Per alcuni tessuti e velluti l'azienda si riserva di applicare la cucitura Cod.00

Description

Standard features

- Frame: wooden structure, solid fir wood and seat suspensions in reinforced elastic webbing.
- Paddings in eco-friendly open cell polyurethane foam, with different densities.
- Back cushions in "Extra soft" fiber.
- Covering in leather or fabric. Armrest, seat and back cushions coverings removable.
- Versions Cod.1421 - 1422 - 1671 - 1672 - 2341 - 2342 - 3031 - 3032 - 9507 with top in Carrara white marble (Cod.CA).
- Legs in Gunmetal (Cod.50).
- Stitching type Cod.01 + Cod.03 for leather covering.
- Stitching type Cod.03 for fabric covering.
- No bed version available.
- Sectional sides finished.

Optional features available upon request without any upcharge

- Stitching, unless differently requested, will be matching the leather or fabric colour. Contrast stitching colour can be ordered at no extra charge. You might use as reference any Nicoline leather.

Optional features available upon request with an upcharge

- 7% upcharge for combined coverings. Please refer to the notes at the beginning of pricelist.
- Versions Cod.1421 - 1422 - 1671 - 1672 - 2341 - 2342 - 3031 - 3032 - 9507 with top in Emperador marble (Cod.EM), Black Marquina marble (Cod.NM).

Notes

- Versions with asterisk (*) have always the terminal side finished with the possibility to be connected to modular elements.
- Different stitchings not available.
- For some fabrics and velvets production dept. must apply the stitching Cod.00

FRONTALE
FRONT

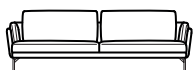

LATERALE
DEPTH

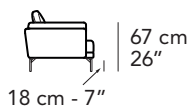
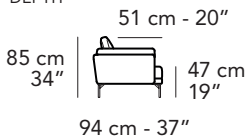

3160



293 cm - 115"

3000

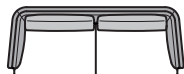

232 cm - 91"

2200

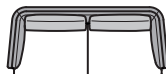

212 cm - 83"

2000

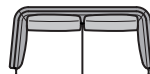

192 cm - 76"

1000



104 cm - 41"

3022

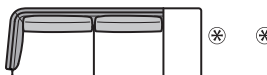

258 cm - 102"

3021

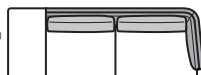

258 cm - 102"

2902

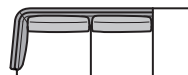

238 cm - 94"

2901

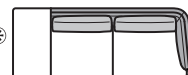

238 cm - 94"

3032

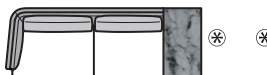

258 cm - 102"

3031

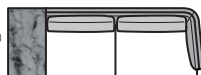

258 cm - 102"

2342

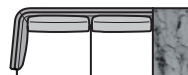

238 cm - 94"

2341

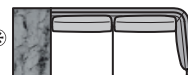

238 cm - 94"

A

1203



92 cm - 36"

1202



117 cm - 46"

1201



117 cm - 46"

3002

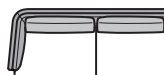

208 cm - 82"

3001

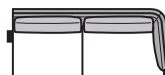

208 cm - 82"

3003

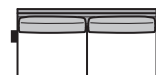

183 cm - 72"

1602

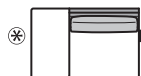

142 cm - 56"

1601

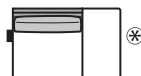

142 cm - 56"

5202

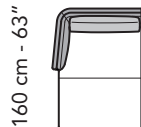

160 cm - 63"

117 cm - 46"

5201

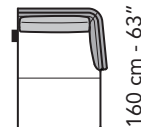

160 cm - 63"

117 cm - 46"

5203

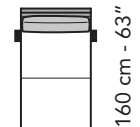

160 cm - 63"

92 cm - 36"

1672



142 cm - 56"

1671



142 cm - 56"

tutti gli elementi del gruppo A hanno lo stesso modulo di seduta - all items in group A have the same seat width

nicoline

A024 - ASTEDIO

B

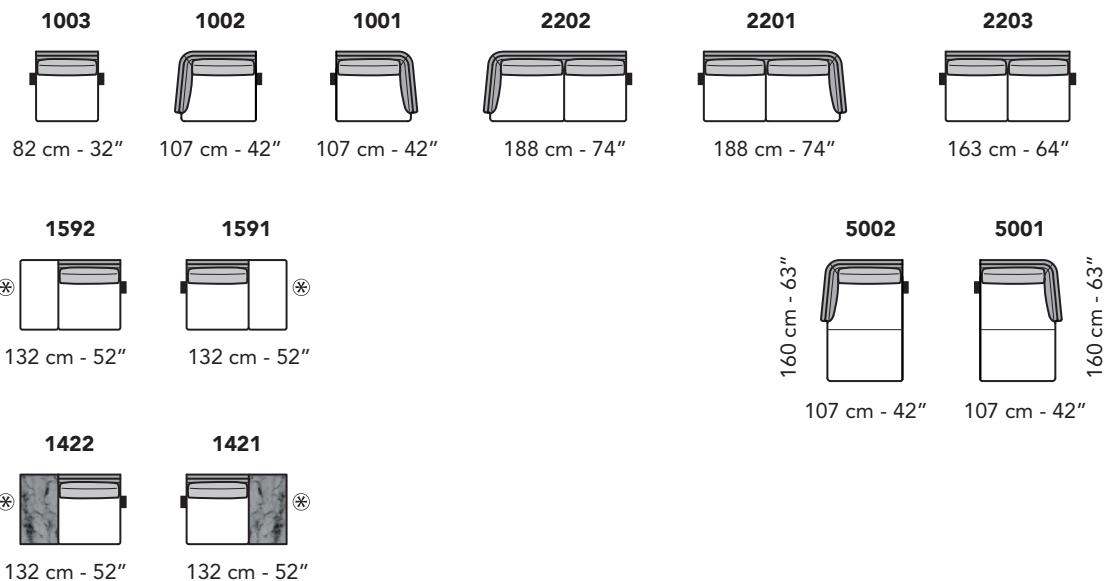

tutti gli elementi del gruppo B hanno lo stesso modulo di seduta - all items in group B have the same seat width

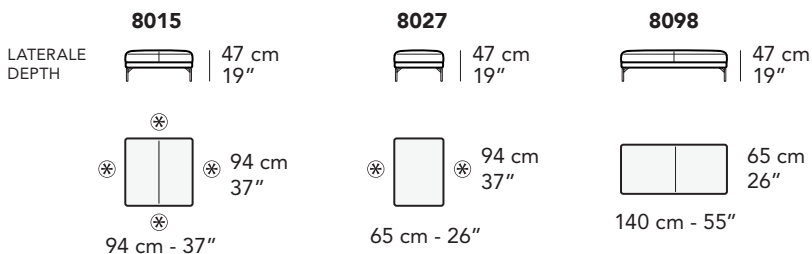
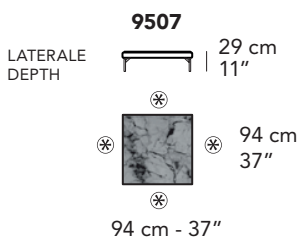
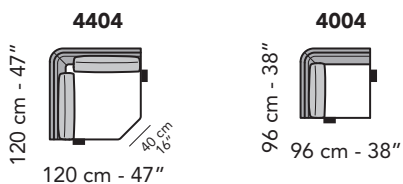

Scala 1:100
Ratio 1 to 100

Legenda / Legend

■ Spalliera / Back Cushions ■ Bracciolo / Armrest
■ Poggiareni / Kidneyrest □ Seduta / Seat Cushions

■ Marmo / Marble

⊗ Lato terminale sempre rifinito e agganciabile agli elementi componibili / Terminal side is always finished and it can also be connected to modular elements

■ Aggancio Componibile / Connector

Composizioni consigliate / Recommended compositions



Regole Generali cosa **NON** fare.
General rules whhat **NOT** to do.

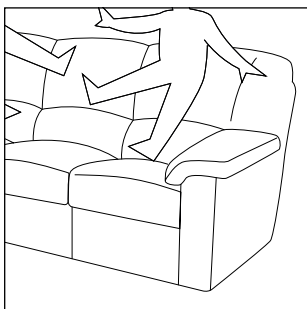

NON saltare o tuffarsi sul divano.
DO NOT jump or dive on the sofa

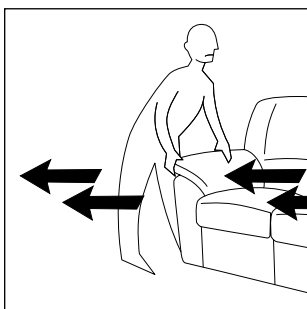

NON tirare il divano dal bracciolo.
DO NOT move the sofa from the armrest

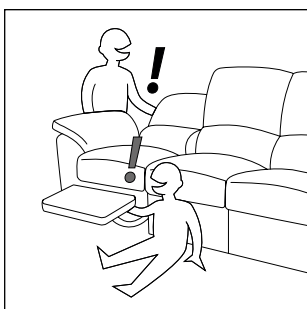

NON giocare con i meccanismi del divano.
DO NOT play with the mechanic of the sofa

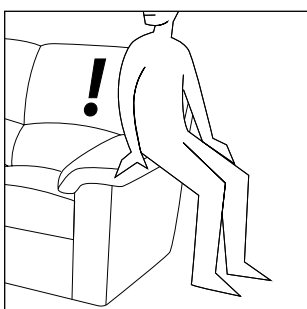

NON sedersi sui braccioli o sullo schienale
DO NOT sit on the armrest or backrest

nicoline.it