



**HEADSETS**  
TECHNICAL GUIDE

## HEADSET BREAKDOWN

HEADSET SELECTION CAN BE TRICKY WITH SUCH A WIDE VARIETY OF AVAILABLE OPTIONS. THIS BOOKLET IS DESIGNED TO SIMPLIFY THE PROCESS AND HELP YOU FIND THE RIGHT HEADSET OPTION TO MEET YOUR REQUIREMENTS.

WE NOW OFFER A SEPARATE TOP AND BOTTOM HEADSET OPTION TO HELP YOU TAILOR YOUR SELECTION MORE EASILY TO YOUR OWN HEAD TUBE AND FORK COMBINATION.



TOP CUP ASSEMBLY

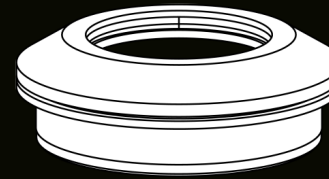

TOP COVER



COMPRESSION RING



BEARING



CUP

BOTTOM CUP ASSEMBLY

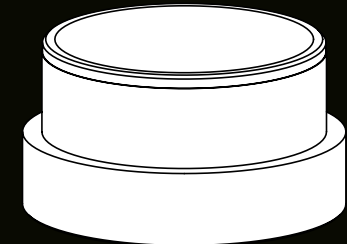
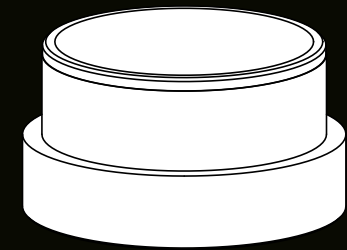

CUP



BEARING



BEARING SEAL



CROWN RACE

## HEADSET CUP FINDER

1 1/8"

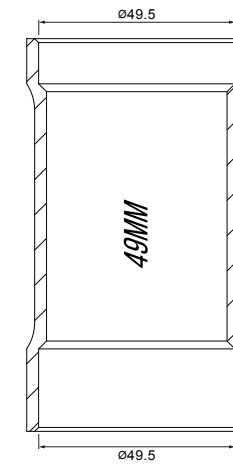
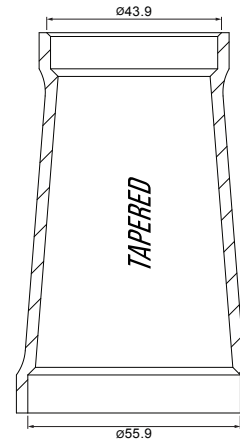
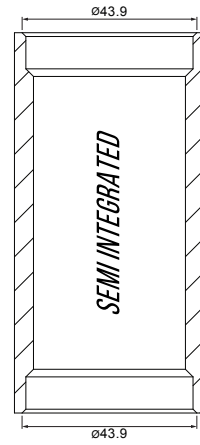
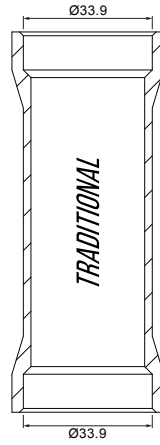
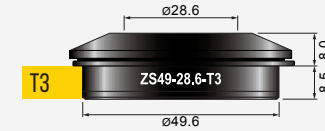
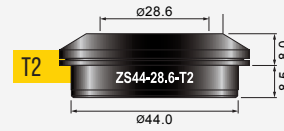
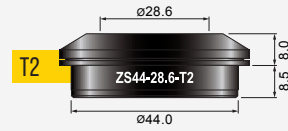
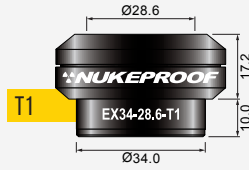

1 1/8

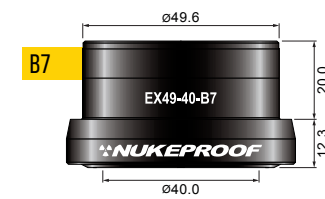
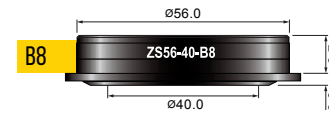
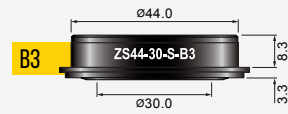
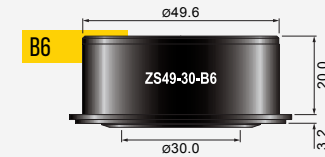
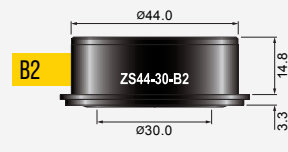
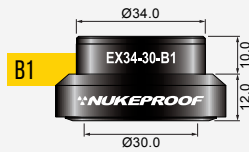

1.5" TO 1 1/8"  
REDUCING CROWN

1.5"

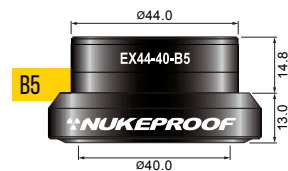

STILL DON'T KNOW WHICH HEADSET YOU NEED?

NO PROBLEM! SIMPLY FOLLOW THE STEP BY STEP GUIDE ON THE NEXT PAGE TO DETERMINE WHICH SIZE AND TYPE OF HEADSET YOU NEED FOR YOUR FRAME.

# STEP 1

REMOVE THE FORK FROM THE FRAME AND MEASURE THE STEERER DIAMETER FOR THE TOP AND THE BOTTOM IN INCHES – A 1 1/8<sup>TH</sup> FORK WILL GIVE 28.6MM FOR THE TOP AND APPROXIMATELY 30MM FOR THE BOTTOM, AND 1.5" WILL GIVE APPROXIMATELY 40MM FOR THE BOTTOM. \*WE DO NOT PROVIDE A 1.5" TOP CUP.

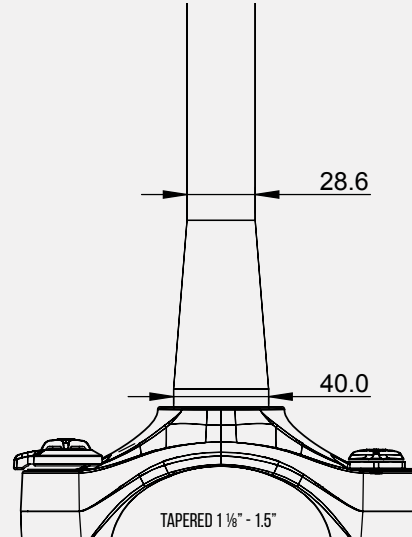
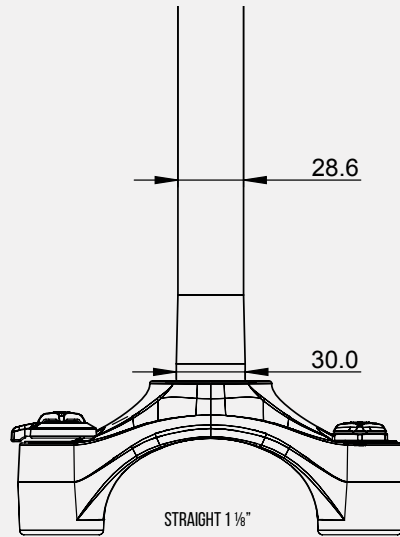

# STEP 2

MEASURE THE INTERNAL DIAMETER OF THE HEAD TUBE FOR BOTH THE TOP & BOTTOM SECTIONS (AFTER YOU HAVE REMOVED THE HEADSET CUPS FROM THE FRAME).

**POSSIBLE OPTIONS FOR TOP:**  
34MM, 44MM, 49MM

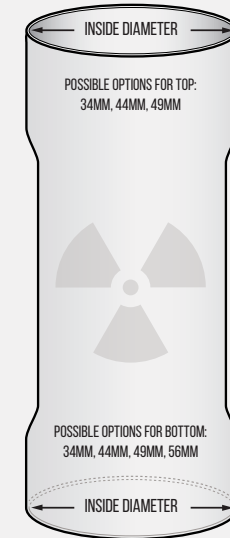

**POSSIBLE OPTIONS FOR BOTTOM:**  
34MM, 44MM, 49MM, 56MM

# STEP 3

NOW USE THE NUMBERS YOU GOT FOR STEPS 1 AND 2 IN THE TABLE BELOW TO FIND THE REQUIRED HEADSET.

## TOP HEADSET CUP OPTIONS

Internal diameter of head tube	Fork diameter (inches)	Cup needed for top (T)	Product Code	Notes
34mm	1 1/8"	T1	EX34-28.6-T1	Traditional 34mm
44mm	1 1/8"	T2	ZS44-28.6-T2	Standard 44mm
49mm	1 1/8"	T3	ZS49-28.6-T3	Reduced 49mm (1 1/8th")

## BOTTOM HEADSET CUP OPTIONS

Internal diameter of head tube	Fork diameter (inches)	Cup needed for bottom (B)	Product Code	Notes
34mm	1 1/8"	B1	EX34-30-B1	Traditional 34mm
	1 1/8"	B2	ZS44-30-B2	Standard 44mm
44mm	1 1/8"	B3	ZS44-30-S-B3	Shallow cup 44mm
	1 1/8"	B4	EX44-30-B4	External 44mm increases stack)
	1.5"	B5	EX44-40-B5	Tapered 44mm (1.5")
49mm	1 1/8"	B6	ZS49-30-B6	Reduced 49mm (1 1/8th")
	1.5"	B7	EX49-40-B7	External 49mm (1.5")
56mm	1.5"	B8	ZS56-40-B8	Standard 1.5"

 **NUKEPROOF**  
WWW.NUKEPROOF.COM

