



MEGAWATT CARBON  
BIKE MANUAL

 **NUKEPROOF**

## CONGRATULATIONS!

### CONGRATULATIONS ON YOUR NEW MEGAWATT CARBON PURCHASE AND WELCOME TO THE NUKEPROOF FAMILY!

The Nukeproof Megawatt Carbon was born from a shared heritage of performance. Nukeproof and SRAM teamed together to bring you the ultimate e-bike experience – the latest and greatest in eMTB technology wrapped in a carbon frame designed to wallop the nastiest trails on the planet. Developed in collaboration with the team at SRAM, the Megawatt was used as the testbed for the first-of-its-kind Eagle Powertrain as it was prototyped over two years.

The SRAM Eagle Powertrain is an integrated eMTB ecosystem that meshes SRAM AXS components, the Eagle Transmission, and a powerful drive unit into one cohesive package. All systems work in unison to bring you an experience elevated above all previous e-bikes.

Settled and stable yet playful and agile, the Megawatt has earned a reputation for surefootedness in terrain where most bikes fight for traction. We didn't want to lose those qualities, so the rear linkage, suspension kinematic, and geometry has only been slightly tweaked from the alloy model.

Your Megawatt Carbon has been meticulously engineered using T700/800 carbon with intricate features and design cues, maximising the bikes efficiency, rider experience and offering ultimate performance. The result is a carbon E-Enduro machine that handles like no other and is purpose built for the new SRAM Eagle Powertrain.

This manual will help you get familiar with your Megawatt Carbon, it's SRAM Eagle Powertrain system, and will serve as a helpful resource for setting-up and maintaining your bike. Please read this manual carefully to help look after and enjoy your Megawatt Carbon to its fullest. If there is any doubts or queries with the set-up, use, or maintenance of your Megawatt Carbon, please consult with an authorised dealer. Full dealer listings can be found at [NUKEPROOF.COM](https://www.nukeproof.com)

Please ensure you also read the [GENERAL BIKE MANUAL](#) before your initial ride.

# CONTENTS

**SECTION 1 - UNBOXING YOUR BIKE**

**SECTION 2 – ASSEMBLING YOUR BIKE**

**SECTION 3 – POWERTRAIN QUICK START GUIDES**

**SECTION 4 – SRAM APP**

**SECTION 5 – SUSPENSION IN MORE DETAIL**

**SECTION 6 - MAINTENANCE AND CARE**

**SECTION 7 – SPECIFICATIONS**

**SECTION 8 - ASSEMBLY AND SPARES**

**SECTION 9 – SRAM COMPONENTS**

**SECTION 10 - TROUBLESHOOTING & ERROR CODES**

**SECTION 11 – WARNINGS**

**SECTION 12 – WARRANTY**

**SECTION 13 – LOGBOOK**

**SECTION 14 – CERTIFICATE OF CONFORMITY**

## SECTION 1 - UNBOXING YOUR BIKE

For mail order customers your new Megawatt Carbon will be delivered in a specifically designed bike box, the type and size of box will vary between retailers. The bike will come with a number of spares, Nukeproof provides tubeless valves and additional items will depend on the dealer you have purchased the bike from. Some Nukeproof dealers will provide pedals and basic tools with the bike on delivery, typically a pedal spanner and Hex Key set.

### PACKAGING ON ARRIVAL

---

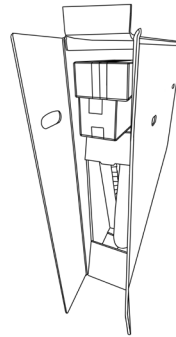
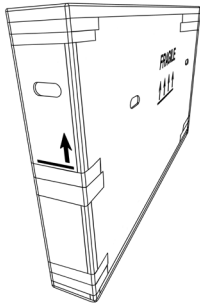

1. Your new bike will arrive in large cardboard box, box size will depend on retailer purchased from.
2. Open end of box carefully, remove parts box and set aside. Please note, if dealer has shipped battery not installed, it is heavy, and care is needed when removing.



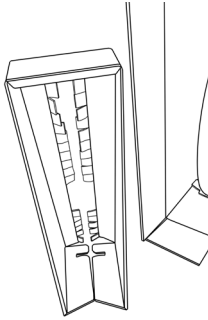

3. Remove cardboard front wheel support from box, this will now allow you to remove the bike.

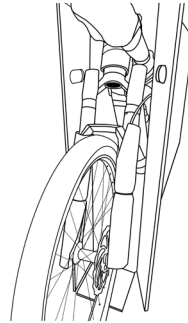

4. Carefully pull bike out of box, we would advise help at this point from another person to hold the box. If your dealer has stapled the box, please ensure staples are removed to prevent paint damage.

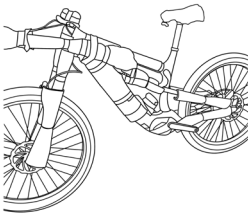

5. The bike will be carefully wrapped before shipping to prevent any damage in transit. If any damage is found, report directly to your dealer.



6. Carefully remove protective wrapping, please dispose of appropriately and recycle where possible.

## SECTION 2 - MAIL ORDER ASSEMBLY AND INITIAL SET-UP

This section details how to get your bike ready for setting up and riding out of the box, this will be relevant for mail order bikes, generally the following will be done already if purchased and collected through a local authorised Nukeproof dealer. Do not turn on your bike at this point.

### FIT BARS

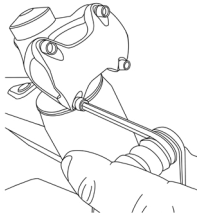

1. Unscrew face plate bolts from stem with a 4mm Hex Key, remove stem face plate and bolts, set aside safely for installing later.

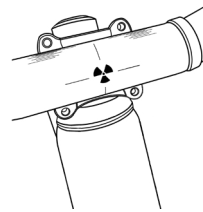

2. Place bars to stem, using the set-up lines to position the bars centrally. Ensure brake lines are not tangled at this point.

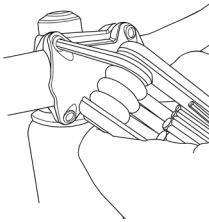

3. Tighten the face plate bolts to the stem with a 4mm Hex Key, start with the top bolts and move to the bottom bolts. Ensure bolt torque is evenly spread around all four bolts before fully tightening. Reference the torque details on the stem.

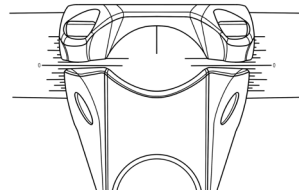

4. You can adjust the roll of the bars back or forward at this point to your personal preference. Ensure the bars are still centered when adjusting and use the markings on the bars to help. This is a good point to adjust position of PODS and brakes levers.

## FIT PEDALS

All Nukeproof pedals are standard 9/16" x 20 tpi so are compatible with all modern cranks.

### TOOLS REQUIRED

- 8mm Hex Key (All pedals) Or 15mm Spanner (Alloy pedals only)
- Torque Wrench
- Grease

### HOW TO DETERMINE THE DIFFERENCE BETWEEN THE LEFT AND RIGHT PEDAL

This step is very important, failure to install the pedals on the correct side of the bike will cause irreparable damage your crank and pedal.

### ALLOY PEDALS

Alloy pedal axles are marked "L" indicating the left pedal (non-driveside) and "R" indicating the right pedal (drive-side).

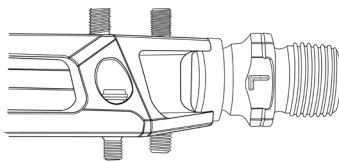

LEFT PEDAL

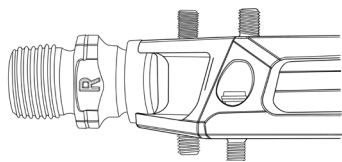

RIGHT PEDAL

### PLASTIC PEDALS

Plastic pedal bodies have an "L" moulded in the body indicating the left pedal (non-driveside) and "R" moulded indicating the right pedal (driveside).

The axles are also different, the left axle has a ring indented around the lip of the axle whereas the right does not.

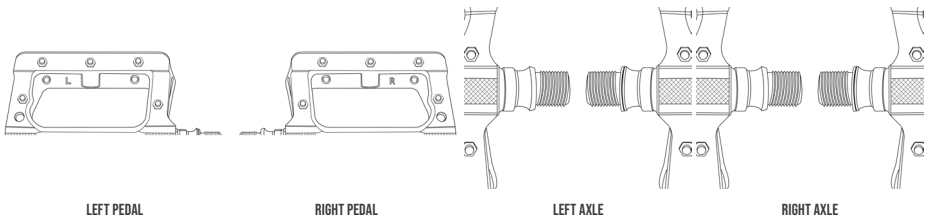

LEFT PEDAL

RIGHT PEDAL

LEFT AXLE

RIGHT AXLE

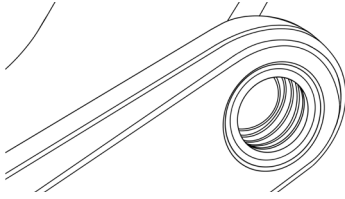

1. Check the threads on your crankarm are clean and have no damage.

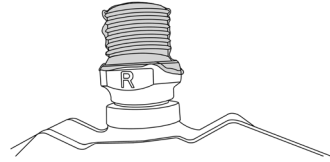

2. Take your RIGHT pedal and grease the axle.

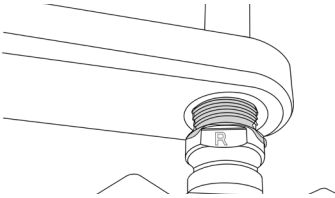

3. Line the pedal up to the driveside crank, place your 8mm hex key through the driveside crank and into the back of the pedal axle. Start to turn the hex key in a clockwise direction (as you look at the crank towards the handlebars). There should be no resistance as you turn the hex key, if there is resistance STOP immediately and check you are fitting the correct pedal and the threads are correctly aligned between the axle and crank. Do not force the pedal into the crank.

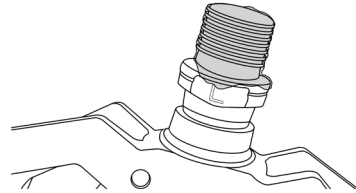

4. Take your LEFT pedal and grease the axle.

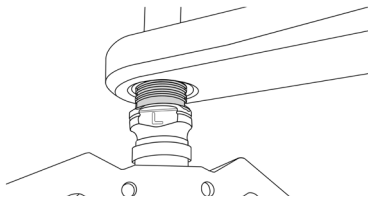

5. Line the pedal up to the non-driveside crank, place your 8mm hex key through the non-driveside crank and into the back of the pedal axle. Start to turn the hex key in an anticlockwise direction (as you look at the crank towards the handlebars). There should be no resistance as you turn the hex key, if there is resistance STOP immediately and check you are fitting the correct pedal and the threads are correctly aligned between the axle and crank. Do not force the pedal into the crank.

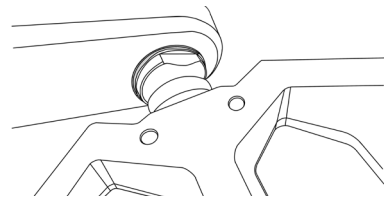

6. With both pedals now on the crank arms, tighten to 30Nm with a torque wrench.

Your pedals are now fitted and safe to ride.

## ADJUST SADDLE HEIGHT

---

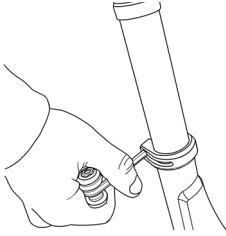

1. To adjust the height of the saddle, loosen the seat clamp bolt with a 5mm Hex Key, once height is adjusted, retighten

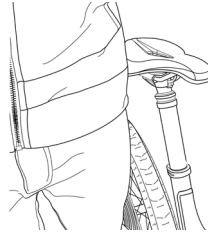

2. To get a starting point for your saddle height, stand beside your bike and adjust the height to your hip bone

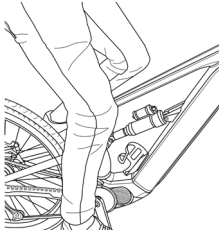

3. Sit on the bike with assistance from another person or leaning against a secure structure. Pedal to the 6 o'clock position to identify if the saddle height is suitable and you can begin to adjust to suit your preference

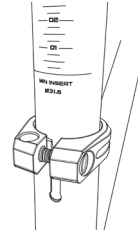

4. Do not exceed the minimum insertion depth marked on the post

## ADJUST SADDLE ANGLE AND POSITION



To ensure comfort when seated pedalling, the saddle position can be adjusted. A Torx 25 (T25) wrench is required.



To adjust the saddle angle, forward and back. Loosen the T25 bolt, position the saddle and retighten the T25 bolt.

## ADJUST STEM HEIGHT

The stem height can be made higher or lower to suit rider preference. The headset spacers can be placed below or above the stem. Do not add too many additional spacers under the stem, as both stem bolts must be clamping fork steerer. If you are unsure on this process, please consult with your authorised Nukeproof dealer to complete the work.

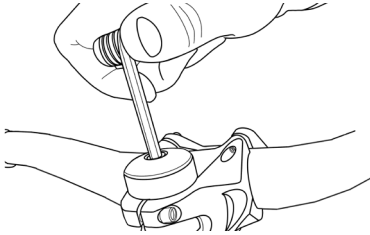

1. Loosen and remove top cap bolt and cover with a 5mm Allen Key.

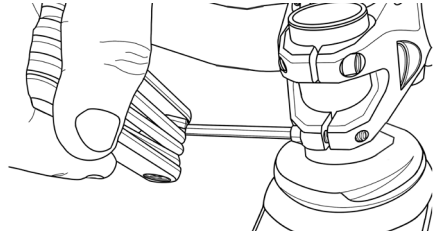

2. Loosen both stem steerer clamp bolts with a 4mm Allen Key

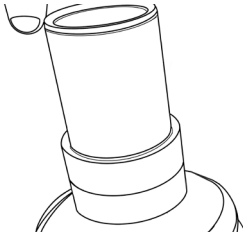

3. Remove stem and place spacers to your preference, in this example two below the stem to raise height. Both spacers can be placed above the stem to lower height as well.

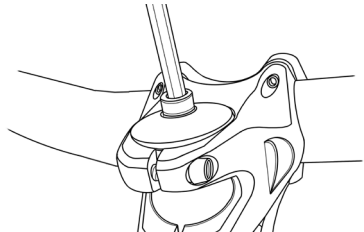

4. Install stem to steerer, replace top cap and bolt and tighten with 5mm Allen Key. If steering becomes stiff, top cap bolt is overtightened.

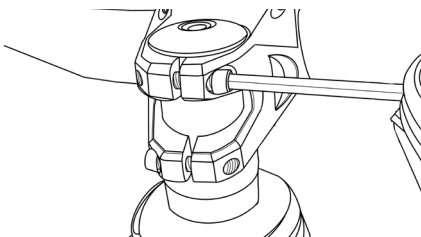

5. Straighten stem and retighten stem steerer clamp bolts with a 4mm Allen key.

## CONVERT TO TUBELESS

All of our adult complete bike's are supplied with tubeless tape installed, tubeless valves and tubeless compatible tyres to make tubeless conversion fast and simple. This guide will take you through the steps to make your bike tubeless.

### ITEMS REQUIRED

- Tubeless pump
- Tubeless Sealant
- Tubeless valves
- Tools to remove wheels (Usually 5mm / 6mm hex for thru axles)
- Tyre levers (not essential with good tyre fitting technique)

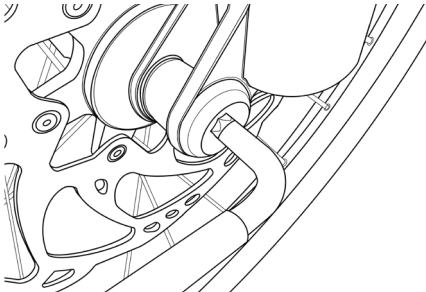
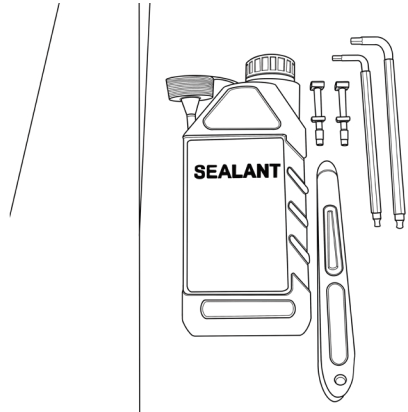

1. Remove your wheel from the bike.

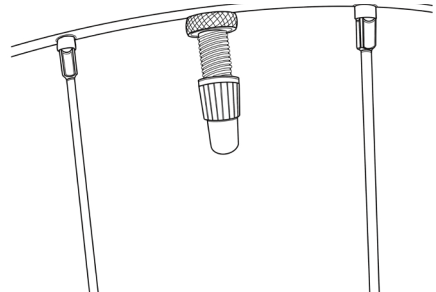

2. Remove valve cap



**NUKEPROOF**

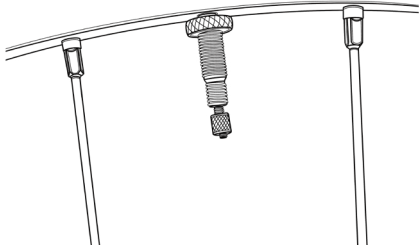

3. Loosen presta valve nut and push to deflate the inner tube.

**NUKEPROOF**

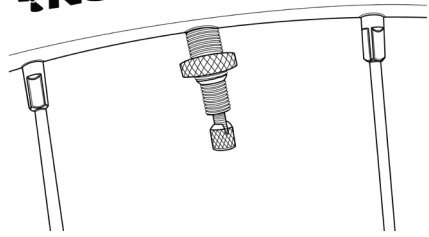

4. When the tube is deflated, remove the nut holding the valve in place.

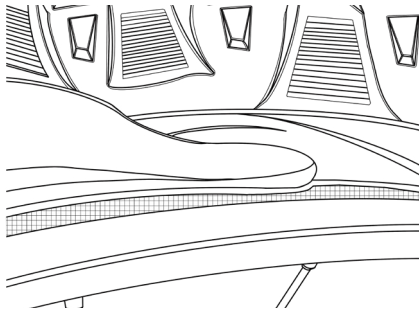

5. Unseat tyre by pushing the bead to the centre of the rim. Do this on both sides of the tyre

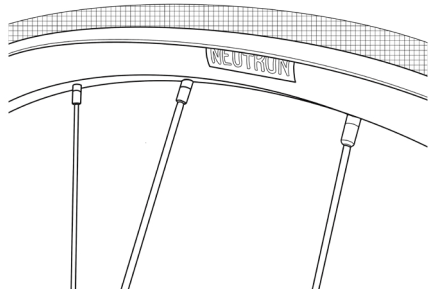

6. Remove one side of the tyre by taking the bead over the rim.

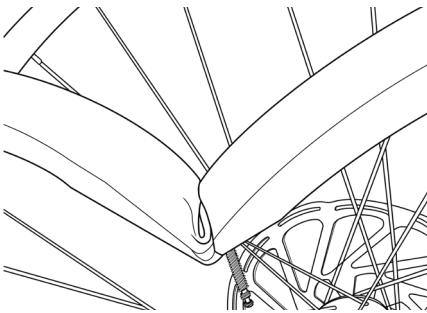

7. Push the valve through the rim and remove the inner tube.

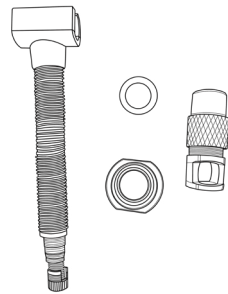

8. Get your tubeless valve and get it ready to install. At this point also double check that the tubeless tape is still correctly stuck down and not damaged. If it has been damaged the rim will need retaped.

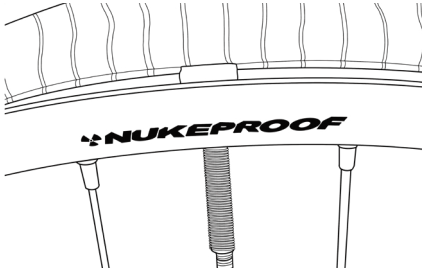

9. Push the valve through the valve hole.

**NUKEPROOF**

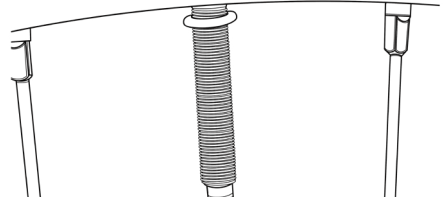

10. Put the o-ring on the valve.

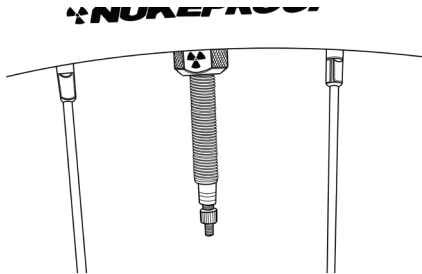

11. Fit the tubeless valve nut and tighten.

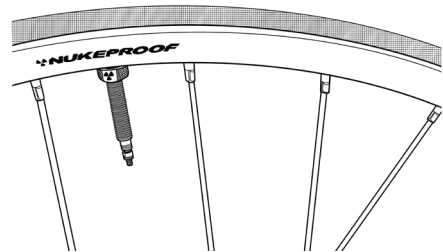

12. Start to refit the tyre, leave 1/4 open.

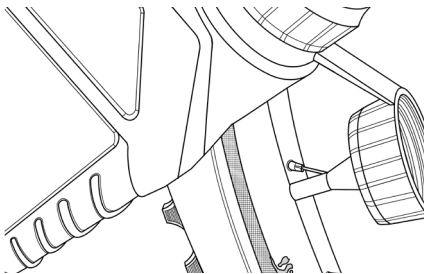

13. Add tubeless sealant as per sealant manufacturer recommended amount.

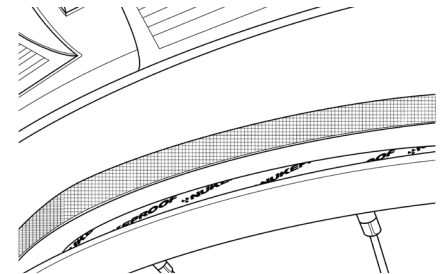

14. Finish fitting tyre. Make sure the bead is pushed to the centre of the rim as this will make it much easier.

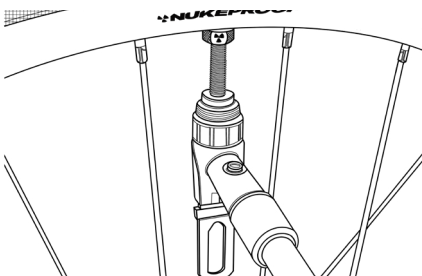

15. Connect your tubeless pump to the valve.

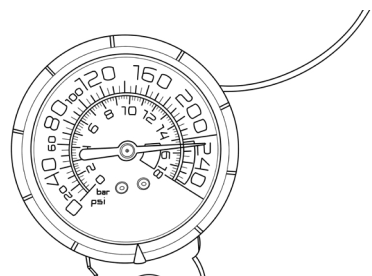

16. Charge the tubeless pump cannister and then release air blast.

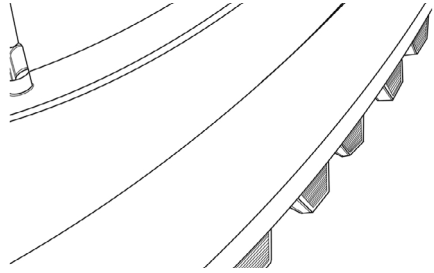
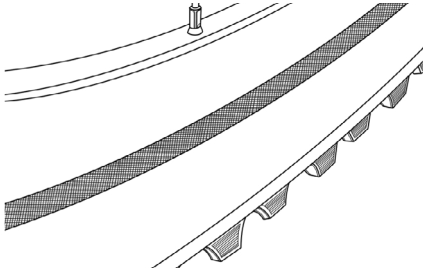

17. Pump tyre until it is correctly seated. There is a moulded line in most tyres which must be visible and uniform the whole way round the tyre.

**NUKEPROOF**

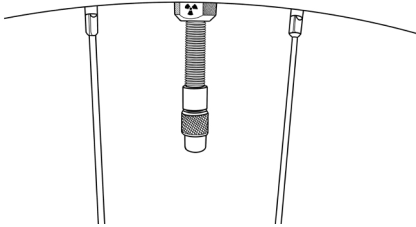

18. Reinstall valve cap.

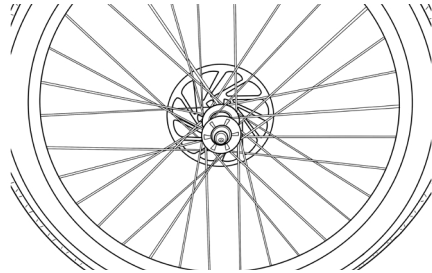

19. Lift your wheel and shake it to get the sealant all round the tyre.

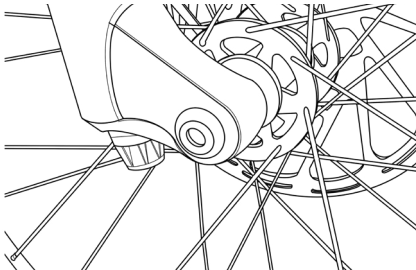

20. Refit your wheel to the bike following the manufacturer's instructions.

## A COUPLE OF POINTS TO NOTE

---

It can take a couple of rides for the sealant to get fully around the tyre settle. Don't be alarmed if you need to top up the air pressure a couple of times between rides. The tyre shouldn't lose pressure during your ride.

Some tyres will seep sealant from the sidewalls. This should settle after the tyre has been used and generally happens on cheaper sealants so we do recommend using a good quality sealant.

If you have an air leak at the rim, it will generally appear to happen at the valve but is most likely to be an issue with the tape. If the air is escaping at the valve then its getting past the tape somewhere and you will need to check your tape is not damaged.

## INSTALLING WHEELS WITH THROUGH AXLES

---

\*In some cases, if you have mail ordered, your chosen authorised Nukeproof Dealer may have shipped the bike without wheels installed. Please reference the following to install wheels with Through Axles to your bike.

Nukeproof bikes typically will use Through Axles.

Insert the wheels to the fork and frame dropouts, ensure the rotor is aligned with the caliper to avoid damage when installing. For the rear wheel please ensure the gears are in the smallest sprocket and pull the derailleur rearwards to give more room for install. Ensure the hub endcaps are seated correctly in the dropouts for a secure fit.

Apply a little grease to the axle and threads and push through the dropouts and hubs until axle cannot be pushed further.

Tighten the Through Axle clockwise to the Nm found on the axle, if no Nm is displayed, please consult with your Nukeproof Dealer.

If the Through Axle is stiff when installing, it may be cross-threading, stop immediately and check seating of hubs and dropouts. Any further concerns please consult with your Nukeproof Dealer.

If the forks have pinch bolt dropouts, reference the forks manufacturer guides for correct installation.

If the Through Axles have Quick Release levers, please reference the axles manufacturers instructions for correct install.

Ensure the correct tools are used when fitting and removing Through Axles, if you are unsure, please consult with your Nukeproof Dealers.

Ensure the Through Axles are checked before and after each ride to ensure they are tight.

Riding with loose Through Axles can result in loss of control, injury and death.

If you are unsure on fitting wheels with Through Axles, please consult with your Nukeproof Dealer.

## GETTING FAMILIAR WITH YOUR BIKES CONTROLS ONCE ASSEMBLED

---

Nukeproof adult bikes are all equipped with powerful modern disc brake systems. Disc brake systems offer exceptional control and power. Please note power will improve with some use once the pads and discs have bedded in. Ensure you familiarise yourself with which lever operates the front or rear brakes. Your dealer will set the brakes to the way they are typically used in your country, but please check lever orientation or get the brakes set to your preference by your dealer. Adjust the position of the brake levers so the lever is in a comfortable position and easy to pull. This is shown in the assembly guide. Brake performance will vary with riding terrain and weather conditions, familiarise yourself with your brakes performance in different conditions.

The gears on the bike are operated by a shifter on the handlebar, moving through the range of gears by clicking up and down the shifter paddles will help with pedaling in different terrains. Gear shifter position can also be adjusted, as shown in the set-up guide. Ensure the shifter is in a position it is easily accessible and use. Ensure when shifting you are pedaling smoothly forward, do not shift and pedal backwards. Pedaling backwards can damage the gears and result in an accident.

When initially getting familiar with your brakes and gears, please ride in a familiar location in good conditions while wearing a helmet. Any issues with your brakes and gears, immediately stop riding and consult with an authorised Nukeproof dealer for maintenance or repair.

## STORAGE

---

Your new Megawatt Carbon will be supplied with an accessory strap. This can be placed under the bikes top tube or inside the Battery Door. Within the Battery Door of your Megawatt Carbon the accessory strap can be located. This allows internal storage of spares and tools. Multitool, Tubeless Plug Kit and CO2 canister can be stored, or a compact TPU type tube. Additional accessory strap can be purchased from your Nukeproof if you wish to fit spares under the top tube and inside the Battery Door.



## SECTION 3 - POWERTRAIN QUICK START GUIDES

### SWITCHING ON YOUR MEGAWATT CARBON FOR THE FIRST TIME

Before you turn on your Megawatt Carbon for the first time you will need to fully charge the battery to wake it from sleep mode. Full charge takes approximately 5 hours for the supplied 720Wh battery.

#### **PLEASE NOTE**

Use only the SRAM manufactured charger and charger cord to charge the battery. Use of a 3rd party chargers and cords may cause the battery to overheat, reduce its service life, catch fire, or explode.



1. If you have a power source accessible to the bike, simply plug your SRAM Powertrain Charger into the power socket and turn on.



2. Now plug the Powertrain Charger into the charging port found on the seat tube.



3. To check the battery is charging, the Bridge Display will indicate the % charge. It will take approximately 5 hours for a full battery charge.

## HOW TO REMOVE AND FIT THE MEGAWATT CARBON BATTERY

The Megawatt Carbon's internal battery can be easily removed. This process is outlined in the images below.



1. To remove or install the battery you will need 5mm Hex Key and a torque wrench.



2. If you do not have a work stand lay the bike on the floor drive side up.



3. First remove the reverse-threaded battery door cap (turn clockwise to remove).



4. Remove the battery door by sliding it downwards and pulling toward the rear of the bike. Set it aside.



5. Unplug the cable from the battery. The cable is secured by magnets and simply pulls apart.



6. While holding the battery in the frame, use a 5mm Hex Key to remove the battery bolt (anti-clockwise).





7. Now, slide the battery out of the down tube. Please ensure a secure grip as the battery is heavy.

## INSTALLING THE BATTERY

---

To refit the battery simply reverse the removal process.



1. Slide the battery up into down tube. There are guides in the frame to align the battery correctly.



2. Install the battery bolt into the battery and tighten the bolt with a 5mm Hex Key.



3. Using a 5mm torque wrench, tighten the battery bolt to 12Nm.



4. Plug the cable into the battery, The cable is held in place with magnets.



5. Re-fit the battery door, using the guides in the frame to seat correctly.



6. Secure the battery door in place with the battery door cap which has a reverse thread (anti-clockwise). The battery door cap only needs tightened by hand.

## HOW TO PUT YOUR MEGAWATT CARBON 720WT BATTERY ON CHARGE

---



With the battery removed from the bike, plug your Powertrain Charger into the power socket.



Now plug the Powertrain Charger into the battery and turn on your sockets power.



You will know the battery is charging when the LED is solid red on the charger, the LED will turn green when fully charged. The battery charge status is displayed on the battery LEDs.

## BATTERY CHARGE STATUS

---

During charging you can check the % status of the battery. Press and release the power button on the Bridge Display. At 100% charge the battery will automatically power off. Remove the charger from the charge port and you can now power on your Megawatt Carbon.

### PLEASE NOTE

---

Your Megawatt Carbon will not power on when the charger is attached and battery in 100% charged. The charger must be unplugged from the charging port before bike powering on.

## DRIDGE DISPLAY



## BATTERY

Charge status can be monitored on the battery when it is removed from the bike. Battery is fully charged when all lights are green with no flashing.



## CHARGING AXS DROPPER POST BATTERY

Your bike will be supplied with a Single Base AXS charger and USB Cable. This is for the Reverb AXS Dropper post battery. Typically, a full charge will take 1 hour.



- To charge, remove protective cover for battery, keep the cover as it will protect the battery connections when stored.
- Connect USB cable to charger and connect to mains power supply.
- Fit battery to charger, charge time is approximately 1 hour.
- A solid Blue light on the Base indicates power is adequate to charger. Flashing Blue indicates weak power supply and charge time will be slower.
- Amber light indicates battery is charging.
- Green light indicates battery is now fully charged.

## GETTING FAMILIAR WITH YOUR MEGAWATT CARBON POWERTRAIN CONTROLS

---

### POWERTRAIN CONTROLS AND BRIDGE

---

Remember to fully charge your Megawatt before the first time you power on.



### BRIDGE DISPLAY FUNCTIONS

---

**A – POWER BUTTON:** Press and hold for startup/shutdown. When bike is on, a short press enters maintenance mode (motor & shift assist off)

**B – AXS BUTTON:** Press and hold for AXS component pairing, ride mode toggle (Rally/Range), on screen menu selection.

**C – RIDE MODE INDICATOR:** Shows whether you're in Rally or Range mode

**D – SHIFTING MODE INDICATOR:** Shows whether you're in assist or manual shifting mode, and assist control setting

**E – BATTERY INDICATOR:** Battery level shown as a percentage

### CONTROLLER FUNCTIONS

---

**L1 – RIDE MODE SELECTOR:** Toggle between Rally and Range. Press and hold for walk assist (limited to 6km/h)

**L2 –** Reverb AXS dropper seat post remote or other assigned AXS action.

**R1 – SHIFTING:** The default upshifter. Hold to activate Shift Assist Mode

**R2 – SHIFTING:** The default downshifter. Hold to access the Assist Control Menu

**R1/R2 –** Menu Selection

**RALLY MODE –** Performance MTB riding mode

**RANGE MODE –** Extend your battery for longer rides and getting to the trailhead

**SHIFT ASSIST –** Automatic gear selection

**ASSIST CONTROL –** Shift Assist adjustment to match your cadence preference [-3, -2, -1, MID, +1, +2, +3]

## EAGLE POWERTRAIN COMPONENT PAIRING PROCEDURE

Your bike will likely come with its wireless components paired. If your bike's AXS components need pairing, the following is the pairing procedure sequence must be followed. Please ensure components are paired before connecting the SRAM AXS app.



**1** Press the power button on the Display to turn the bike ON.

**2** Press and hold the AXS button on the Display until the pairing session starts.

Display ready for pairing

Press and hold the AXS button on the Rear Derailleur until the LED on the display blinks quickly.

**3**

**NOTICE**  
The Right Controller must be paired into the system before the Left Controller to properly assign the system controls.

Right Controller

Press and hold the AXS button on the Right Controller until the LED on the display blinks quickly.

**4**

Left Controller

Press and hold the AXS button on the Left Controller until the LED on the display blinks quickly.

**5**

Right Controller

Press and hold the AXS button on the Reverb AXS Seatpost until the LED on the display blinks quickly.

**6**

**7** Press the AXS Button on the Display to complete the pairing session.



## HOW TO SET UP YOUR REAR SUSPENSION SAG

Sag is the amount the rear shock will compress under the rider's weight while kitted. This is the base setting for the rear shock to ensure the rear suspension is neither too stiff nor too soft. It's recommended the Megawatt Carbon's sag be set with the rider seated.



Rear shock sag on the Megawatt Carbon should be set to 30% for optimum suspension performance.



To set sag, first slide the red sag ring to the seal of the shock as shown.



Always set your sag when the bike is on a level surface. Have another person help steady the bike or use an object to hold yourself up. Sit on the bike while wearing all of your normal riding kit.



To add or remove air, remove the rear shock valve cap and set aside. Screw the shock pump on until the pressure gauge shows a PSI reading. Now observe the sag indicator while seated and add or remove air until you achieve 30% exactly. Do not exceed the stated maximum air pressure printed on the shock.



Bounce on the bike to cycle the shock through its travel a few times to balance the positive and negative air chambers. Once the desired pressure is achieved, unscrew the shock pump. Now repeat steps 3-10 if needed until the sag is reading 30% exactly.



Once sag is correctly set, re-fit the valve cap to the rear shock.



## HOW TO SET UP YOUR FRONT SAG

You will need to set-up front sag to balance the bikes suspension with the rear sag. Front sag will be your base setting and with use you can adjust the sag to suit rider preference, riding style and terrain.



For Front suspension, consult the chart on the back of the fork leg to find your recommended air pressure settings, this will be based on rider kitted weight.



To add or remove air, remove the valve cap from the fork and set aside.



Screw the shock pump on until the pressure gauge shows a PSI reading. Use the pump to add or remove air until the gauge matches the recommended setting.



Cycle the fork through its travel a few times to balance the positive and negative chambers. Push the fork up and down to balance.



Once the desired pressure is achieved, unscrew the shock pump carefully to ensure no pressure is lost from the fork.



Re-fit the valve cap to the fork.

## FRAME SERIAL NUMBER LOCATION

---

The unique frame number for your Megawatt Carbon is found inside the down tube of the frame. You will need to remove the battery from the frame and the serial number will be found above the battery bolt entry hole. Your dealer and Nukeproof bikes do not have an obligation to keep a record of this number. Please take a note of this number for insurance, theft prevention/recovery purposes and in the unlikely case you need to make a warranty claim.



## GETTING FAMILIAR WITH POWERTRAIN AUTO SHIFT, COAST SHIFTING, MANUAL SHIFTING AND PUSH MODE

Now your bike is ready to ride, you will need to familiarise yourself with shifting and Push Mode. The Megawatt Carbon Eagle Powertrain has an Auto Shift feature. The Auto Shift setting will automatically shift the Megawatt Carbon into the appropriate gear when pedalling and coasting. The Powertrain system uses pedal speed input and bike speed to select the most suitable gear. Auto Shift can be overridden by making a manual shift with the Control Pods and Auto Shift will reactive after 5 seconds.

### TURNING AUTO SHIFT ON & OFF

To toggle Auto Shift on & off, press and hold the top button on the right-side Pod. On/off will be shown on the Bridge Display.

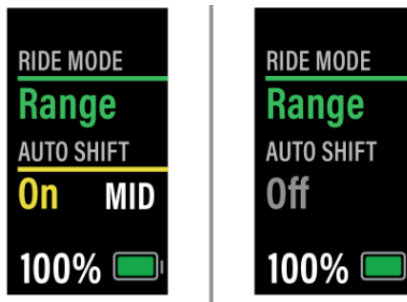

### ADJUSTING AUTO SHIFT BASED ON CADENCE

Powertrain allows for adjustment of Pedal Speed (cadence) while using Auto Shift. By default, the Pedal Speed is set to MID, this is recommended by SRAM but can be tweaked to your preference. To increase cadence, adjust to +1, +2, +3, to reduce cadence adjust to -1, -2, -3.

- To open the Pedal Speed menu, press and hold the right-hand POD Controller lower button. Releasing the button will allow access to the speed settings, after 3 seconds of no input the Bridge Display will return to the home page.
- To go down the Pedal Speed -3, -2, -1 (slower cadence) settings, use the lower Pod Control Button.
- To go up the Pedal Speed +1, +2, +3 (higher cadence) settings, use the upper Pod Control Button.

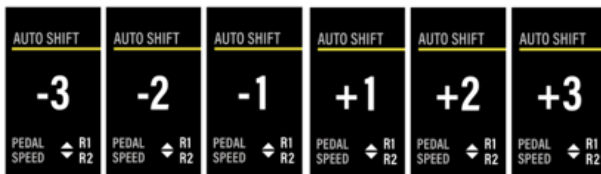

## COAST SHIFTING

---

Powertrain will Auto Shift gears when you are not pedalling, this is to ensure the bike is in the correct gear relative to the speed of the bike. This is beneficial when riding through rough terrain and pedalling to change gears poses a risk of pedal strikes. When Auto Shift is switched off, a manual shift will spin the Power Unit and change the gear without pedalling.

## AUTO SHIFT TURNED OFF / MANUAL SHIFTING

---

If you do not wish to use Auto Shift and change gears yourself, Powertrain can be changed to manual gear operation.

## PLEASE NOTE

---

Manual shifts can be made any time with Auto Shift on.

- To move to a smaller cassette sprocket, press the top button on the right Pod Controller.
- To move to a larger cassette sprocket, press the bottom button on the right Pod Controller.



## PUSH MODE

---

This is helpful for when you are off the bike and need to push your bike, the motor will activate to help you push the bike with no pedal input.

To activate Push Mode, Press and Hold the upper button of the Left Pod Controller. Holding the button in while pushing will give you motor assistance. After 5 minutes of inactivity or when the button is released, Push Mode will deactivate. Assistance will only activate when motion is detected.

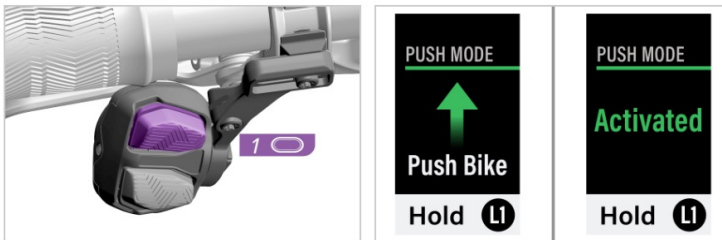

## GETTING FAMILIAR WITH YOUR BIKE BEFORE HITTING THE TRAILS

---

Nukeproof Megawatt Carbon bikes are equipped with powerful hydraulic disc brake systems. Disc brake systems offer exceptional control and power. Please note power will improve with some use once the pads and discs have bedded in. Ensure you familiarise yourself with which lever operates the front or rear brakes. Your dealer will set the brakes to the way they are typically used in your country, but please check lever orientation or get the brakes set to your preference by your dealer. Adjust the position of the brake levers so the lever is in a comfortable position and easy to pull. Brake performance will vary with riding terrain and weather conditions, familiarise yourself with your brake's performance in different conditions.

The gears on the bike are operated by a shifter on the handlebar, moving through the range of gears by clicking up and down the shifter buttons or Auto Shift will help with pedalling in different terrains. Gear shifter position can also be adjusted to suit your preference. Ensure the shifter is in a position it is easily accessible and use. Ensure when shifting you are pedalling smoothly forward, do not shift and pedal backwards. Pedalling backwards can damage the gears and result in an accident.

When initially getting familiar with your brakes and gears, please ride in a familiar location in good conditions while wearing a helmet. Any issues with your brakes and gears, immediately stop riding and consult with an authorised Nukeproof retailer for maintenance or repair.

## SRAM GUIDES

---

SRAM have comprehensive guides for a deep dive into Powertrain. For further reading and knowledge please familiarise yourself with SRAMs literature.

### [SRAM POWERTRAIN GUIDES](#)

## SECTION 4 - SRAM AXS APP

The SRAM Eagle Powertrain connects to your phone through the SRAM AXS app. Available for free from all major app stores, to create an account, add your components and customise your Megawatt Carbon AXS set-up.

### THE AXS APP ALLOWS FOR THE FOLLOWING:

- Connection of your AXS and Powertrain components using Bluetooth to the AXS app.
- Build and customise a number of bike profiles.
- Review bike performance and readiness.
- Customise component settings to match your riding style and preferences.
- Assign custom actions to your handlebar controls.

To customise component settings within the SRAM AXS app, all AXS components must be paired into a single system. The pairing procedure is detailed in the Quick-Start portion of this manual for you to reference, please ensure the controls are paired to the rear derailleur and seatpost.

To ensure optimal AXS and Powertrain performance please ensure you have installed the most up to date SRAM AXS app and component firmware. Updates for component firmware are performed through the app.

Please note: Your AXS rear derailleur is hardwired to the Megawatt Carbon's main battery. Ensure the bike is powered on before performing derailleur firmware updates. If the bike is powered off during firmware updates, the update may fail, and the update process will need restarted.

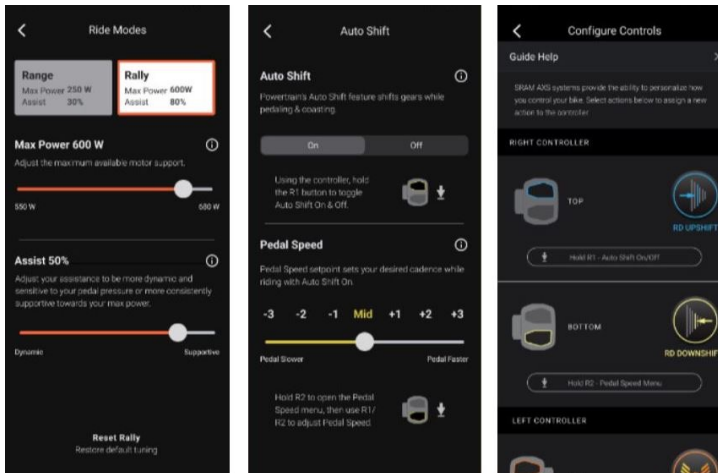

## SRAM GUIDES

---

SRAM have comprehensive guides for a deep dive into the AXS App. For further reading and knowledge please familiarise yourself with SRAMs literature.

### [SRAM POWERTRAIN GUIDES](#)

## SECTION 5 - SUSPENSION IN MORE DETAIL

To get the most out of your Megawatt Carbon you will need to set-up and maintain your suspension. Suspension maintenance is specialist work that we recommend only be performed by official service centres. Suspension service intervals are detailed in the manufacture's user guides.

Before your first ride, the suspension will need adjusted. The recommended sag for the Megawatt Carbon is 30%, seated with riding kit on. You will need a shock pump to set your sag as shown in Quick-Start Guide. The rebound and compression settings are subject to terrain, riding style and rider preference. Adjust the settings as you ride to find what works best for you. Remember when setting your rear shock, the lock-out is in the off position.

Before setting up your suspension, please read the full manual for your shock and fork. SRAM has comprehensive guides for set-up and service on their webpages. Identify the serial number on the fork and rear shock, enter the serial number into the SRAM service website to find the required guides.



Vivid Air Shock Serial Number Position



ZEB Fork Serial Number Position

[SRAM SERVICE GUIDES](#)

[ROCKSHOX SUSPENSION SET-UP GUIDE](#)



## SUSPENSION ADJUSTMENT FUNDAMENTALS

---

Before adjusting your Megawatt Carbon suspension settings, it's good to understand suspension terminology to get the most from your set-up.

### REBOUND

---

This controls the return speed of suspension after compression. The return (rebound) speed of the suspension will affect traction and control. Optimising your rebound at a controlled speed will help maintain traction and control, this is also rider preference and terrain sensitive. Set the rebound to quick, and the suspension will bounce off trail objects losing traction and control. Rebound that is too slow will result in the suspension packing into its travel and not rebounding for the next trail impact. Please make incremental changes to rebound to find a setting that suits your riding style and terrain. Incremental changes will also ensure the suspension action remains familiar and does not work in a manner that is uncontrolled.

### COMPRESSION

---

Suspension can be supplied with 'Low-Speed Compression' (LSC) and 'High-Speed Compression' (HSC) damping adjustment.

#### LSC

---

This refers the damping of the suspension during slower compressions. Typically, this would be affected by rider weighed shifts, landing drops/jumps onto transitions, cornering, smaller/less often bumps and braking forces. Increasing LSC helps keep the suspension higher in its travel to help maintain speed on smoother terrain but can reduce sensitivity. Decreasing LSC allows the suspension to compress easier and work better on rougher terrain.

#### HSC

---

his refers the damping of the suspension during quicker compressions. Typically, aspects of riding that include fast/large hits, square edge impacts, and large drops or jumps. Increasing the HSC will help prevent bottom out on large impacts but may reduce sensitivity. Decreasing HSC will allow the suspension to move quicker in bumpier terrain but is more likely to bottom out under large impacts.

Comprehensive set-up guides for the RockShox suspension installed to the Megawatt Carbon can be found on the SRAM Service webpage.

### SHOCK SIZE / TUNE / UPGRADING

---

If you wish to change your shock for an upgrade or a different model to your preference, please consult with your suspension supplier to ensure the shock is the correct size and the tune suits the kinematics of the Megawatt Carbon. The following

details will help with fitting a new shock and ensuring the tune is suitable.

## SIZE

---

Shock Length - 230x65mm

Hardware - 25x8mm / 30x8mm

Bearing End - Note a standard eyelet shock without a bearing end can be used with the correct hardware size. Please ensure the hardware matches the shock and the required size for the frame. If a bearing end shock can be sourced, this would be preferential to ensure the smoothest suspension action.

## TUNE

---

When purchasing a new shock, the provider will need a tune to suit the Megawatt Carbon suspension kinematics, the charts provided below will need to be referenced by your suspension provider. The Megawatt Carbon has a progressive layout, which ensures more support the further you push through the travel for a stable and predictable ride. This is a 24% change in leverage ratio from start to finish. Anti-squat is at 102% at sag for a 50t sprocket and reduces to 50% at the 10t sprocket. This is to aid with traction when climbing keeping a supple suspension action and pedal bob is reduced by the smooth power provided by the Eagle Powertrain motor. Anti-rise is balanced on the Megawatt Carbon to ensure some squat under breaking, helping with rider position and traction.

## LEVERAGE RATIO AND FORCES

The leverage ratio is the ratio between the distance the rear wheel moves vs. the distance the shock moves as the suspension cycles.

The Megawatt Carbon is an evolution of the current proven Megawatt and Mega platforms. we have increased the starting rate a little to help with beginning to Mid- Stroke suppleness, Mid-Stroke to End-Stroke has increased in progression to help with Mid-Stroke and End-Stroke support and improve the lively poppy feel. The travel has also increased as a result to 172mm. This strikes a balance of a super supple beginning stroke for small bump compliance with a strong Mid-Stroke support for stability in cornering and pumping.

### Megawatt Carbon 24% progression

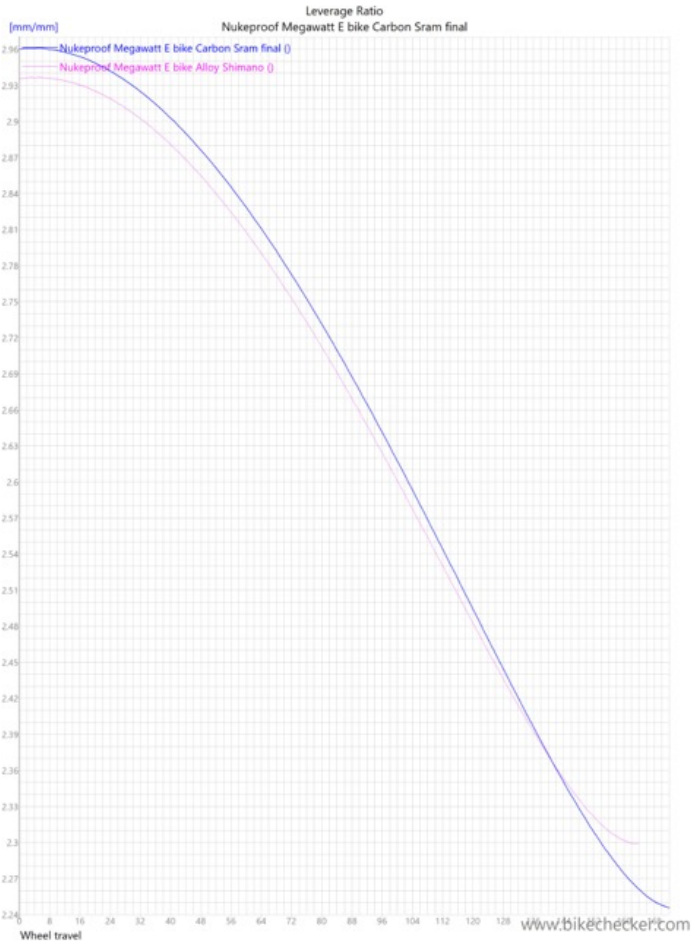

## ANTI SQUAT

Anti-squat is suspension's mechanical resistance to compression due to chain forces from the rider.

We have increased the Megawatt Carbon Anti-Squat to 102%. Higher Anti-Squat in the climbing gears, which drops off to 52% in the descending gears. The Megawatt remains true to our belief that a low Anti-Squat, but good Mid-Stroke support is a winning combo for climbing traction. However, we believe that the Anti-Squat should never prevent the suspension from working well over rough terrain.

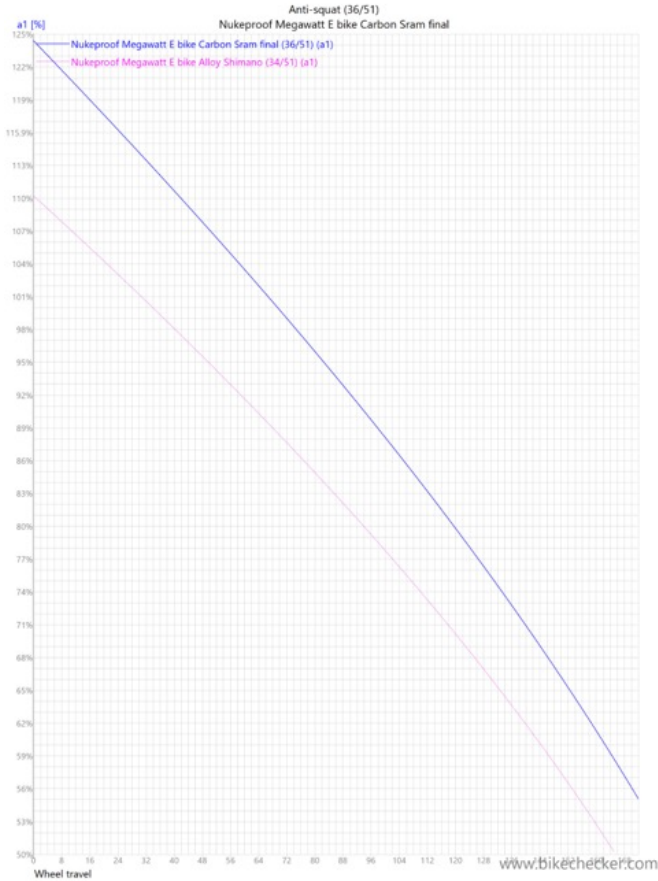

## ANTI RISE

Anti-rise is how much the bike resists the rear-end rise that occurs when we pull the brakes.

The Megawatt Carbon has a balanced amount of Anti-Rise that tails off for bigger hits on the trail. This allows some squat in the suspension when breaking hard into a corner allowing the rider to maintain their position. This allows the rider to put pressure through the tyres and into the ground for excellent traction under hard braking.

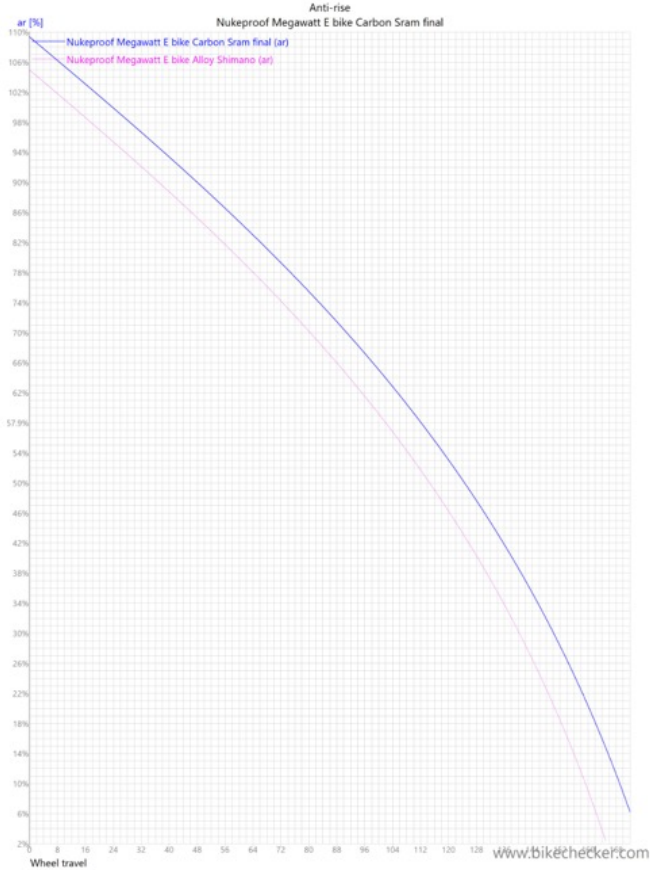

## AXLE PATH

Axle path is the line the rear axle takes as the suspension moves, measured relative to the mainframe.

The new suspension layout of the Megawatt Carbon has affected the Axle path to give a more rearward movement of 65mm. This helps prevent the rear wheel from hooking on square edges and ultimately enable you to carry more speed in rougher terrain.

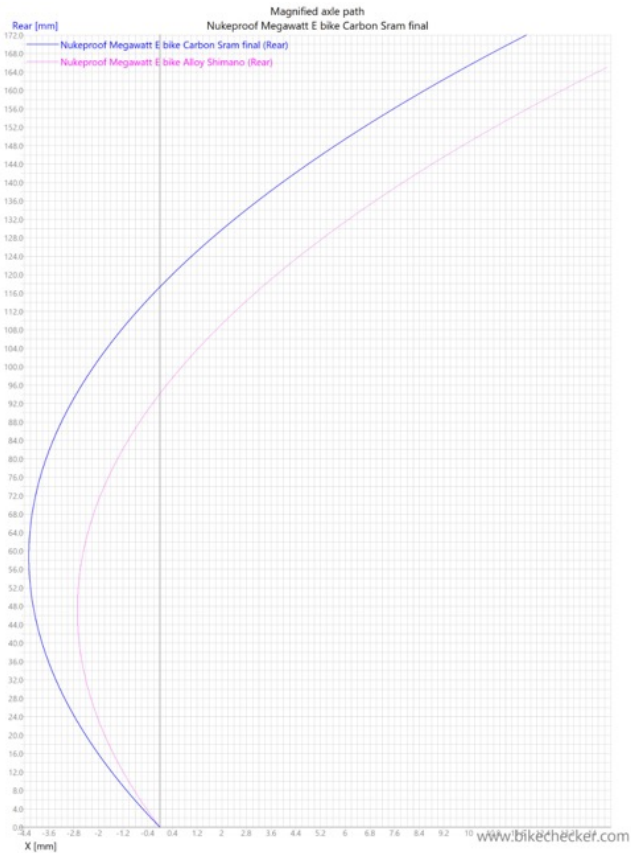

## SUSPENSION FORK LIMITATIONS

---

The fork length also detailed as axle to crown (A-C) cannot be exceeded. Maximum axle-to-crown (A-C) for the Megawatt Carbon is 596mm. Using a fork that exceeds the listed axle-to-crown (A-C) may lead to frame failure and injury and will void the bike's warranty. The bike is designed with a 170mm travel fork in mind, but a 180mm fork can be used as long as the axle-to-crown (A-C) is not exceeded. A dual crown/triple clamp fork cannot be installed to the Megawatt Carbon.

## SECTION 6 - MAINTENANCE AND CARE

Nukeproof bikes and components are designed to be hardwearing and corrosion resistant, but to ensure the bike looks and runs its best some general maintenance will be required. This will ensure the bike looks great for longer, prolong the lifespan of components, and ensure your safety. Please consult with your retailer if you have any questions.

**NOTE:** Service Mode – A short press of the On/Off button on the top tube Bridge Display will activate Service Mode. Service Mode deactivates the motor assist but keeps the system on. This is essential for when the bike is in a workstand, or any maintenance is taking place. The cranks can be manually turned, and the gears shifted. Service Mode is also recommended when the bike is being used without motor assistance.

### BEFORE YOU RIDE

---

Please inspect your bike before each ride to ensure your bike is in full working order. If there are any issues you cannot resolve yourself, please consult with a local reputable mechanic and escalate to an authorised Nukeproof dealer if needed. Any small concern with your bike could develop into a further issue and ruin your ride or become a safety concern. If you have any doubts, please seek advice from your dealer.

### FRAME AND FORK

---

Please do a visual check of your frame and forks. Any cracks or sharp dents, please contact your dealer immediately for inspection and do not ride your bike. Any unusual noises or creaks, please have your bike inspected by a reputable mechanic and escalate to your dealer if needed. Check all pivot points and bearings for signs of play, any play please check the pivot bolts for the correct torque, this is detailed in this document. If all torques are correct and play is still present, your frame bearings may have perished. This document details the bearings required for the frame and please use a reputable mechanic or authorised dealer to replace.

### DRIVETRAIN AND BRAKES

---

Please ensure your drivetrain is cleaned and lubricated often to avoid premature wear. Unusual noises from your drivetrain could suggest your derailleur needs adjusted, parts have worn out, or become loose or damaged. Your Megawatt Carbon uses wireless AXS shifting and therefore will not have gear cables to maintain. The brakes should be inspected often for pad and rotor wear and changed when required. Ensure the brakes are operating correctly before use and ensure there is no play in the calipers and rotors. If play is found, please torque fitting bolts to manufacturers respective guidelines. Brakes will need bled occasionally, how often is dependent on conditions, riding style and terrain.



## WHEELS AND TYRES

---

Check wheel axles before each ride to ensure they are not loose. If loose tighten to torque specification. Check wheels for bearing wear and play, damage, loose spokes and trueness. Wheel bearings are a perishable part and will need changed occasionally. Please consult with a mechanic or authorised Nukeproof dealer to replace bearings and ensure spoke tension. If the rim is damaged/cracked, please refrain from riding your bike and consult with an authorised dealer for a replacement. Tyres will need checked for damage and wear. Cuts in the tread and sidewalls can lead to a tyre failure. Ensure tyre pressure is within range of the manufacturer specification found on the sidewall. Never pump the tyre above the recommended pressure found on the sidewall, this can result in tyre failure, damage to bike, and injury.

## HEADSET

---

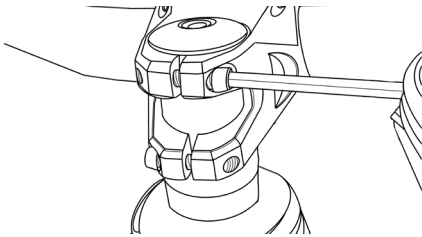

If your headset has play, loosen the two steerer clamp bolts with a 4mm hex key.

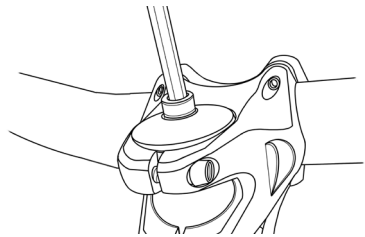

Tighten the steerer bolt with 5mm hex key until play is removed. Retighten the two 4mm steerer bolts and ensure the stem is straight. Any doubts in this process please consult with an authorised Nukeproof Dealer

If there is play in the headset when the front brake is applied, this is a sign the bearings have perished or an adjustment is required. To adjust the headset, loosen the two stem steerer bolts, tighten the top cap bolt, and then retighten the stem steerer bolts again to manufacturer specification. This will pull the headset together and remove play. If the play continues, please contact an authorised dealer for replacement bearings or an inspection. Please note if the headset is overtightened, the steering may become stiff.

## REAR ROTOR CHANGE

It is important to maintain your bikes disc rotors. Rotors will need changed periodically depending on bike use, riding conditions, and riding style. Rotors will need changed when 1.7mm minimum wear thickness is exceeded, brake pad material compound is changed, or a rotor is damaged. Particular attention must be taken with the rear rotor when installing.

- Powertrain compatible rotors must be used. Rotors must be 2mm thick and installed with 15mm rotor bolts. If you are unsure on the correct rotor to use, please consult with your Nukeproof Dealer or a SRAM Dealer. Using an unsuitable rotor may lead to brake failure and injury.
- Please note that dirt accumulation on the Magnets and Speed Sensor may cause system errors, ensure these are cleaned regularly.

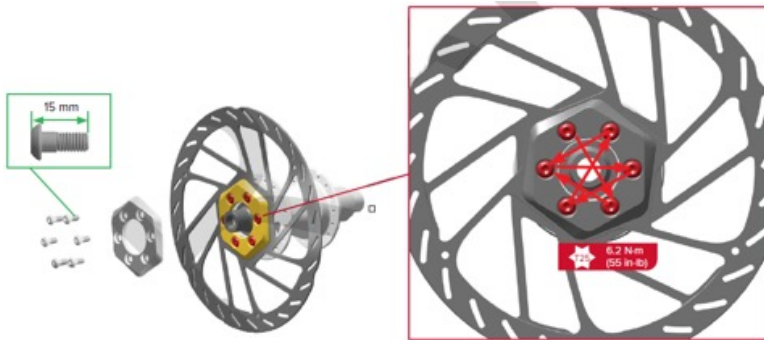

- To remove the bolts a T25 Torx Key is required.
- Carefully remove the Speed Ring, clean lightly with water and soap.
- Install new rotor followed by the Speed Ring.
- Loosely tighten bolts with T25 and finish tightening each bolt in the shown sequence using a T25 Torque Wrench to 6.2Nm.

## GENERAL

Pre-ride, check all bolts are tight and comply with the torque values detailed in this document, third party components installed to your bike must be checked with the respective manufacturers detail, suspension is correct pressure and within range of manufacturers recommendations and tyres are within pressure range of manufacturers detail found on the sidewall. All bearings are consumable parts, wheels/headset/bottom bracket/frame bearings will need checked and changed periodically. If you consider a bearing has perished prematurely, please consult with your dealer for warranty inspection.

## CLEANING

Cleaning your bike regularly will help maintain its appearance as well as prolonging the life of wear and tear parts. Allowing dirt to collect on the bike will reduce the life span of components, increase chances of unnecessary damage and make

visual inspection difficult. We recommend biodegradable cleaning products and do not use a pressure washer. Using a pressurised washer can cause water ingress, damage components and flush out bearing/pivot grease. Please lubricate your drive train after cleaning, wiping off any excess lubricant. Avoid any lubricants contaminating brakes pads and rotors. When cleaning the bike, do not remove the battery, this will protect the connections between the battery and bike.

## SERVICE LIFE

---

Your bike is subject to normal wear and tear of mechanical components. The service life is subjective to several factors, including materials and design, rider weight, how often the bike is used, aggressiveness of the riding and terrain, environment, and maintenance. Regular cleaning, maintenance, and periodical inspection by mechanics will prolong the service life of your bike and its installed components.

## SPARE PARTS

---

All available Megawatt Carbon frame spares and Nukeproof components spare parts are available through any authorised dealer, first port of call will be your dealer, but any authorised Nukeproof dealer can assist. Third-party components and spares can be found through respective dealer networks and your Nukeproof Dealer.

## [NUKEPROOF DEALERS](#)

## [SRAM/ROCKSHOX DEALER LOCATOR](#)

## SECTION 7 - SPECIFICATION/SIZING/GEOMETRY/FEATURES/STORAGE

### FRAME SPECIFICATION

The following are available after market frame spares for the Megawatt, if any part you need is not listed, please consult with an authorised Nukeproof Dealer.

Material	Ultra Strong T700/800 Carbon Fibre Monocoque Construction
Fork Travel	170mm
Axle to Crown	582mm
Fork Offset	44mm
Rear Travel	170mm
Wheels Size	Front: 29" Rear: 27.5"
Max Tyre Size	2.6"
Recommended Shock Sag (Measured seated)	30%
Shock Size	230x65mm
Shock Hardware F	25x8mm
Shock Hardware R	30x8mm / Bearing End
Sizing	S/M/L/XL/XXL
Headtube	56-66mm Tapered Semi-Integrated
Headset	ZS56-28.6 / ZS66/46 (1.8" Tapered)
Bearings Required	4x 6802 LLU MAX, 5x 6902 LLU MAX, 2x F6901 LLU MAX
Seatpost	31.6mm (Internal Routing for Dropper Seatpost)
Seat Clamp	36.4mm
Motor System	SRAM Eagle Powertrain Drive Unit
Battery	SRAM Eagle Powertrain Battery 720wH
Rear Hub	Boost 148x12mm
Rear Axle	Sram UDH Maxle Stealth M12x1.0 180mm (Thread Length 13mm)
Brake Mount	200mm Direct Post
Chaining Size	36T
Protection	3D Contoured Rubber Frame Protection for DT/SS/CS

### RECOMMENDED SIZING

S	160CM/5'3" - 167CM/5'6"
M	167.5CM/5'6" - 178CM/5'10"
L	178CM/5'10" - 183CM/6"
XL	183CM/6" - 193CM/6'4"
XXL	193CM/6'4" - 198CM/6'6"

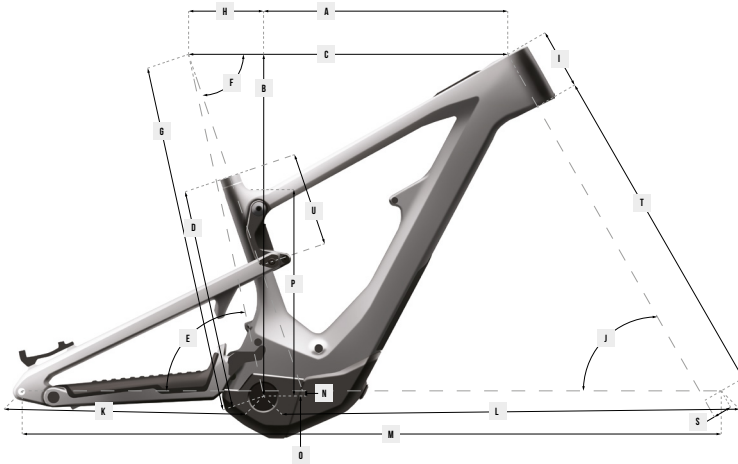

	SM	MD	LG	XL	XXL
(A) Reach	435	455	475	495	515
(B) Stack	624.29	633.25	642.19	651.14	660.09
(C) Effective Top Tube	573.4	595.39	611.5	633.4	655.31
(D) Seat Tube Length	380	410	440	460	480
(E) Effective Seat Tube Angle	77.5°	77.5°	78°	78°	78°
(F) Seat Tube Angle	71°	71°	72°	72°	72°
(G) Saddle Height At Saddle Offset	650	700	750	800	850
(H) Saddle Offset At Saddle Height	140.84	157.22	165.52	181.03	196.54
(I) Head Tube Length	100	110	120	130	140
(J) Head Tube Angle	63.5°	63.5°	63.5°	63.5°	63.5
(K) Chainstay Length	447	447	447	447	447
(L) Front Centre	778.23	802.69	827.16	851.62	876.08
(M) Wheelbase	1225.28	1249.74	1274.04	1298.51	1322.97
(N) Bottom Bracket Drop (Front/Rear)	-30/-10	-30/-10	-30/-10	-30/-10	-30/-10
(O) Bottom Bracket Height	348.50	348.50	348.50	348.50	348.50
(P) Standover Height	737.33	737.33	742.87	742.87	748.19
(Q) Fork Travel	170	170	170	170	170
(R) Trail	141.78	141.78	141.78	141.78	141.78
(S) Fork Offset	44	44	44	44	44
(T) Based On Axle To Crown	582	582	582	582	582
(U) Max Seatpost Insert	216	248	275	305	340

\*All dimensions in mm unless otherwise stated

## FRAME DETAILS

- 1 - T700/800 full carbon fibre frame
- 2 - Removable battery
- 3 A/B - Internally sleeved cable routing
- 4 - Integrated AXS Bridge Display
- 5 - Works with up to a 500ml water bottle





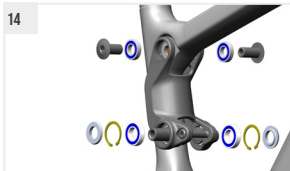
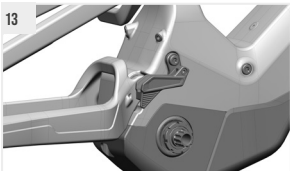
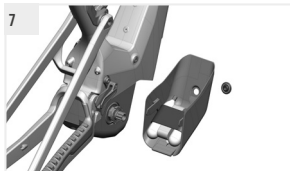
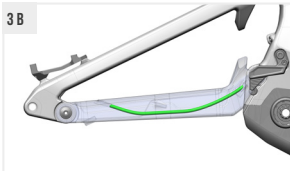



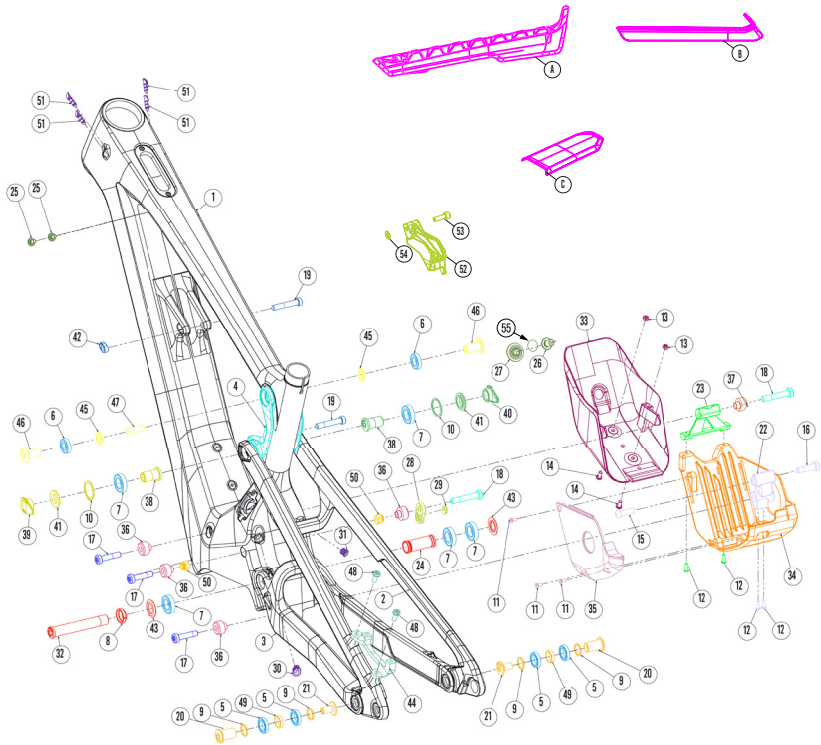

















- 6 - Loads of mud clearance for 2.5" tyres
- 7 - Integrated storage within bash guard
- 8 - TT accessory mounting points
- 9 - ST designed for maximum length dropper post
- 10 A/B/C - 3D contoured rubber frame

- protection for DT, CS, SS
- 11 - 148mm hub spacing
- 12 - Clear protection kit to protect paint
- 13 - Integrated chain guide included
- 14 - Full compliment max bearings



## SECTION 8 - ASSEMBLY AND SPARES



	Shock Bolt Kit		Swing Link
	Bearing Kit		Motor Protector Kit
	Horst Link Kit		Non-Drive Motor Cover
	Main Pivot Kit		Upper Motor Mount Kit
	Upper Swing Link Kit		Lower Motor Mount Kit
	Lower Swing Link Kit Non-Drive Side		Motor Cradle Drive-Side Cover
	Lower Swing Link Kit Drive Side		Motor Bolt 35mm
	Grommet Kit		Motor Bolt 46mm
	Rubber Frame Protection		Motor Bolt Spacer Round
	Hanger		Motor Bolt Spacer Square
	Battery Bolt Kit		Motor Bolt Nut
	Water Bottle Mount		Chain Guide Kit
	Motor Mount Bolt		Brake Mount Kit

## EXPLODED PARTS

#	NUKEPROOF PART #	QTY
1	Front Triangle	1
2	Seat Stay	1
3	Chain Stay	1
4	Swing Link	1
5	6802 Liu Max	4
6	6901 Liu Max	2
7	6902 Liu Max	5
8	Main Pivot Axle Collett Washer	1
9	Horst Link Washer	4
10	Lower Swing Link Lock Ring	2
11	None-Drive Motor Cover Bolt	3
12	Motor Mount Bolt	4
13	Accessory Mount Nut	2
14	Accessory Mount Screw	2
15	Lower Motor Mount Bolt None-Drive	1
16	Lower Motor Mount Bolt Drive-Side	1
17	Motor Bolt 35mm	3
18	Motor Bolt 46mm	2
19	Shock Bolt	2
20	Horst Link Pivot Axle	2
21	Horst Link Bolt	2
22	Lower Motor Mount	1
23	Upper Motor Mount	1
24	Main Pivot Bearing Spacer	1
25	Upper Battery Bolts	2
26	Lower Battery Bolt	1
27	Lower Battery Bolt Cap	1
28	Chain Guide Mount	1
29	Chain Guide Flip Chip	1

30	Brake Hose Grommet	1
31	Derailleur Cable Grommet	1
32	Main Pivot Axle	1
33	Motor Protector	1
34	Motor Cradle Drive-Side Cover	1
35	None-Drive Motor Cover	1
36	Motor Bolt Spacer Round	4
37	Motor Bolt Spacer Square	1
38	Lower Swing Link Bolt	2
39	Non-Drive Side Seat Stay Chip	1
40	Drive Side Seat Stay Chip	1
41	Lower Swing Link Washer	2
42	Shock Bolt Nut	1
43	Main Pivot Washer	2
44	Brake Mount	1
45	Upper Swing Link Pivot Spacer	2
46	Swing Link Pivot Bolt	2
47	Swing Link Pivot Axle	1
48	Brake Mount Bolts	2
49	Horst Link Bearing Spacer	2
50	Motor Bolt Nut	2
51	Headtube Cable Bungs	4
52	Chain Guide	1
53	Chain Guide Bolt	1
54	Chain Guide Washer	1
55	Lower Battery Bolt Cap O-Ring	1
A	Cs Protection	1
B	Ss Protection	1
C	Dt Protection	1



## SPARE PARTS KITS

KIT NAME	DRAWING #	PART #	PART NAME	QTY
Megawatt Carbon Lower Swing Link Kit Drive Side	38	NPB9-RBT	Lower Swing Link Bolt	1
	10	IR-28	Lower Swing Link Lock Ring	1
	41	NPB9-W27-15-4T	Lower Swing Link Washer	1
	40	NPB9-SPT-R	Drive Side Seat Stay Chip	1
Megawatt Carbon Lower Swing Link Kit Non-Drive Side	38	NPB9-RBT	Lower Swing Link Bolt	1
	10	IR-28	Lower Swing Link Lock Ring	1
	41	NPB9-W27-15-4T	Lower Swing Link Washer	1
	39	NPB9-SPT-L	Non-Drive Side Seat Stay Chip	1
Megawatt Carbon Swing Link	4	NPB9B-LK	Swing Link	1
Megawatt Carbon Bearing Kit	5	6802 LLU MAX	6802 LLU MAX / 6802V-2RS	4
	6	6901 LLU MAX	6901 LLU MAX/ 6901V-2RS	2
	7	6902 LLU MAX	6902 LLU MAX/ 6902V-2RS	5
	32	NPB9-LAX	Main Pivot Axle	1
Megawatt Carbon Main Pivot Kit	8	AFDC-CWS	Main Pivot Axle Collett Washer	1
	43	NTR-BWS	Main Pivot Washer	2
	24	NPB9-BSP	Main Pivot Bearing Spacer	1
Megawatt Carbon Battery Bolt Kit	26	NPB9-BTM10X24.5L	Lower Battery Bolt	1
	25	NPB9-BTBT	Upper Battery Bolt	2
	27	NPB9-BTSN	Battery Door Cap	1
	55	O-Ring 18x1.5	Lower Battery Bolt Cap O-Ring	1
Megawatt Carbon Motor Protector Kit	13	M5X2.7L	Accessory Mount Nut	2
	14	M5X10L-R11Q	Accessory Mount Screw	2
	33	NPB9-MOCV-A	Motor Protector	1
Megawatt Carbon None-Drive Motor Cover	11	M4X10L-M11Q	None-Drive Motor Cover Bolt	3
	35	NPB9-MOCV-C	None-Drive Motor Cover	1
Megawatt Carbon Upper Motor Mount Kit	12	M4X12L-R11Q	Motor Mount Bolt	2
	23	NPB9-BGM	Upper Motor Mount	1
Megawatt Carbon Lower Motor Mount Kit	12	NPB9-BGM	Motor Mount Bolt	2
	15	M8X25L-R11Q	Lower Motor Mount Bolt None-Drive	1
	16	MB-T40-30L	Lower Motor Mount Bolt Drive-Side	1
	22	NPB9-AR	Lower Motor Mount	1
Megawatt Carbon Motor Cradle Drive-Side Cover	34	NPB9-MOCV-B	Motor Cradle Drive-Side Cover	1
Megawatt Carbon Motor Bolt 35mm	17	MB-T40-35L	Motor Bolt 35mm	1
Megawatt Carbon Motor Bolt 46mm	18	MB-T40-46L	Motor Bolt 46mm	1
Megawatt Carbon Motor Bolt Spacer Round	36	NPB9-MOW	Motor Bolt Spacer Round	1
Megawatt Carbon Motor Bolt Spacer Square	37	NPB9-MOWC	Motor Bolt Spacer Square	1
Megawatt Carbon Motor Bolt Nut	50	NPB9-BTMO	Motor Bolt Nut	2
Megawatt Carbon Chain Guide Kit	28	NPB9-CG	Chain Guide Mount	1
	29	NPB9-CG-A	Chain Guide Flip Chip	1
	30	VBFB-LMCG	Derailleur Cable Grommet	1
Megawatt Carbon Grommet Kit	31	VBFB-RMCG	Brake Hose Grommet	1
	51	VLD-1442	Headtube Cable Bungs	4
Megawatt Carbon Chain Stay Protection	A	VLFC-1584e	Chain Stay Protection	1
Megawatt Carbon Seat Stay Protection	B	VLFC-1585e	Seat Stay Protection	1
Megawatt Carbon Down Tube Protection	C	VLFC-1605e	Down Tube Protection	1

## TORQUE, GREASE AND DIAGRAMS

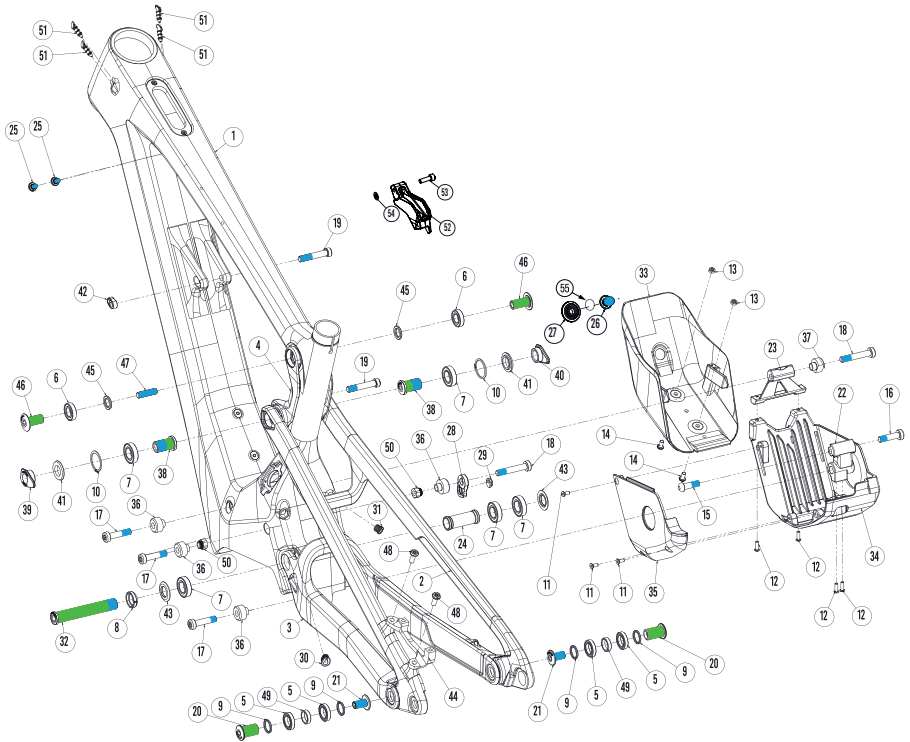

### Thread Lock

Drawing Number	Part Number
38	Lower Swing Link Bolt
21	Horst Link Bolt
32	Main Pivot Axle
25	Upper Battery Bolts
26	Lower Battery Bolt
17	Motor Bolt 35mm
18	Motor Bolt 46mm
16	Lower Motor Mount Bolt Drive-Side
19	Shock Bolt
47	Swing Link Pivot Axle
15	Lower Motor Mount Bolt None-Drive

### Recommended Torque Values





Drawing Number	Part Number	Torque
46	Swing Link Pivot Bolt	14Nm
38	Lower Swing Link Bolt	19Nm
20	Horst Link Pivot Axle	12Nm
21	Horst Link Bolt	12Nm
32	Main Pivot Axle	19Nm
25	Upper Battery Bolts	8Nm
26	Lower Battery Bolt	12Nm
17	Motor Bolt 35mm	15Nm
18	Motor Bolt 46mm	15Nm
16	Lower Motor Mount Bolt Drive-Side	15Nm
19	Shock Bolt	15Nm

### Grease

Drawing Number	Part Number
46	Swing Link Pivot Bolt
38	Lower Swing Link Bolt
20	Horst Link Pivot Axle
32	Main Pivot Axle

NOTE: Use medium strength threadlockwe recommend loctite 243



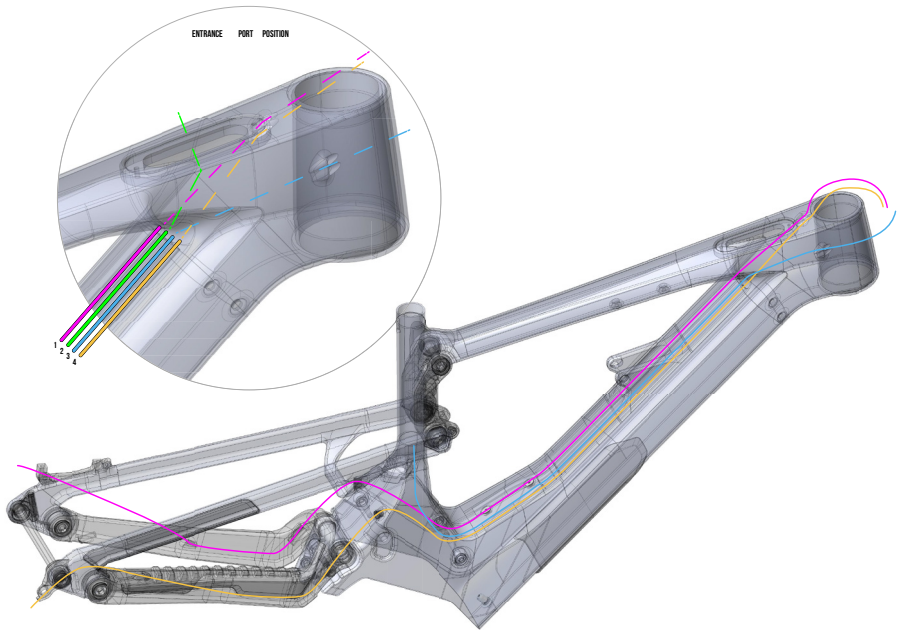

## USA BRAKE & DROPPER CABLE ROUTING GUIDE \*

-  1 - Rear brake routing
-  2 - AXS display unit wire routing
-  3 - Dropper post routing
-  4 - Rear derailleur routing

\*Please note bikes supplied with wireless dropper post and derailleurs, routing for reference proposes if components changed to cabled items









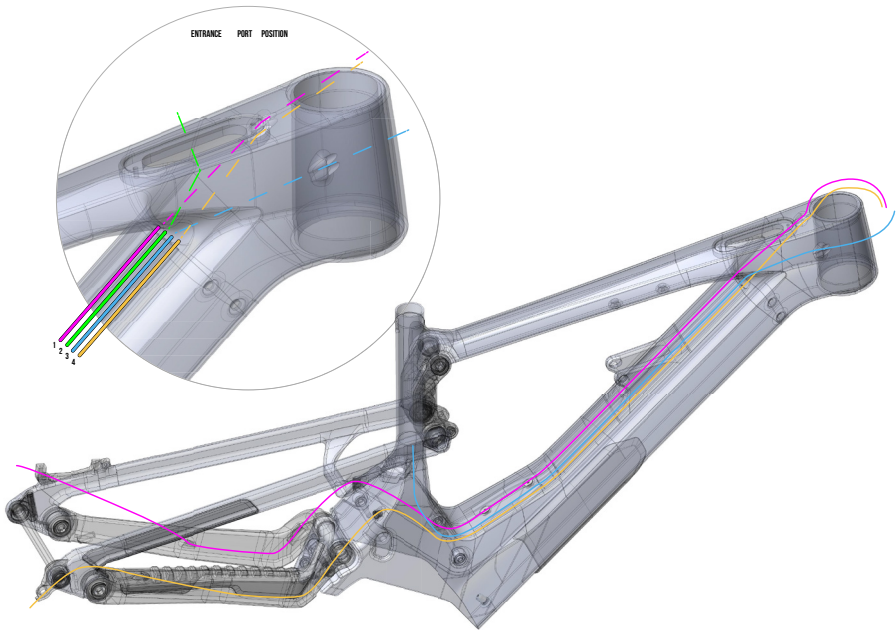

## UK BRAKE & DROPPER CABLE ROUTING GUIDE\*







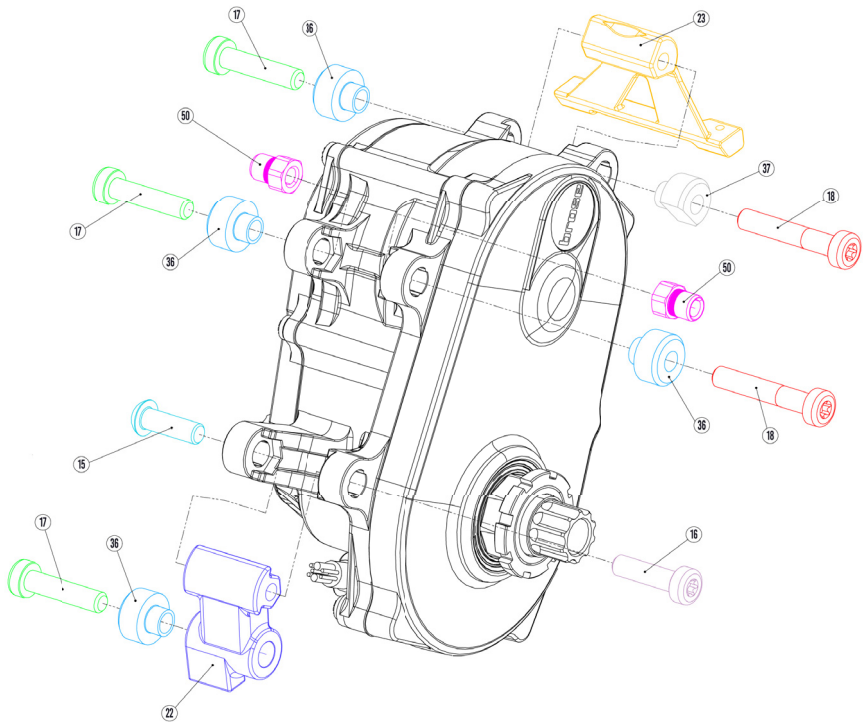

-  1 - Rear brake routing
-  2 - AXS display unit wire routing
-  3 - Dropper post routing
-  4 - Rear derailleur routing

\*Please note bikes supplied with wireless dropper post and derailleurs, routing for reference proposes if components changed to cabled items



DRAWING #	PART	
22	LOWER MOTOR MOUNT	
23	UPPER MOTOR MOUNT	
36	MOTOR BOLT SPACER ROUND	
37	MOTOR BOLT SPACER SQUARE	
50	MOTOR BOLT NUT	
15	LOWER MOTOR MOUNT BOLT NON-DRIVE SIDE 25MM	
16	LOWER MOTOR MOUNT BOLT DRIVE-SIDE 30MM	
17	MOTOR BOLT 35MM	
18	MOTOR BOLT 46MM	



DRAWING #	PART	
22	LOWER MOTOR MOUNT	
23	UPPER MOTOR MOUNT	
36	MOTOR BOLT SPACER ROUND	
37	MOTOR BOLT SPACER SQUARE	
50	MOTOR BOLT NUT	
15	LOWER MOTOR MOUNT BOLT NON-DRIVE SIDE 25MM	
16	LOWER MOTOR MOUNT BOLT DRIVE-SIDE 30MM	
17	MOTOR BOLT 35MM	
18	MOTOR BOLT 46MM	

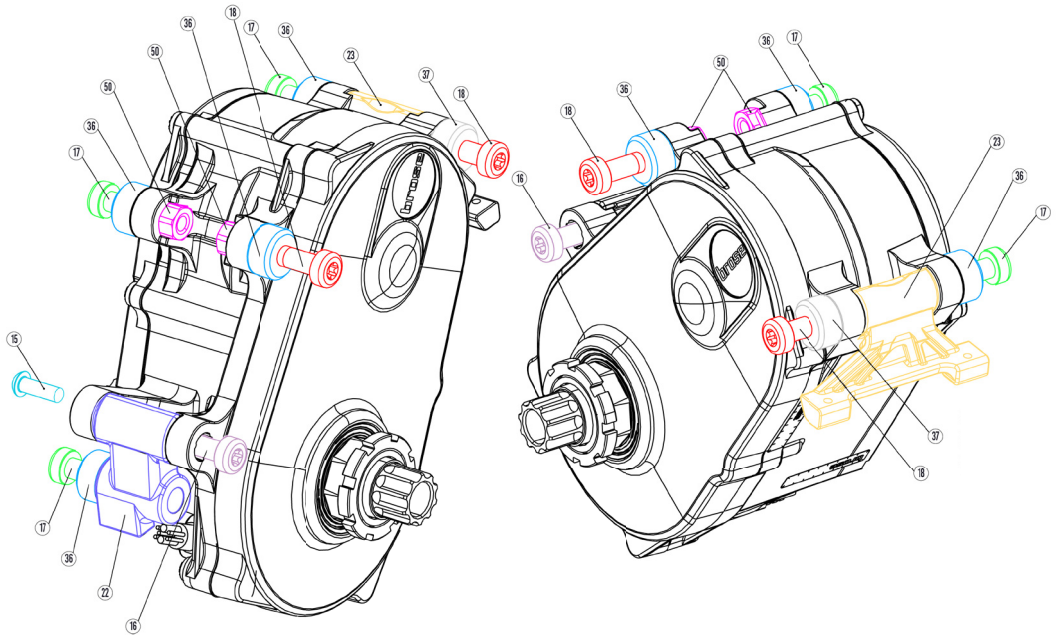

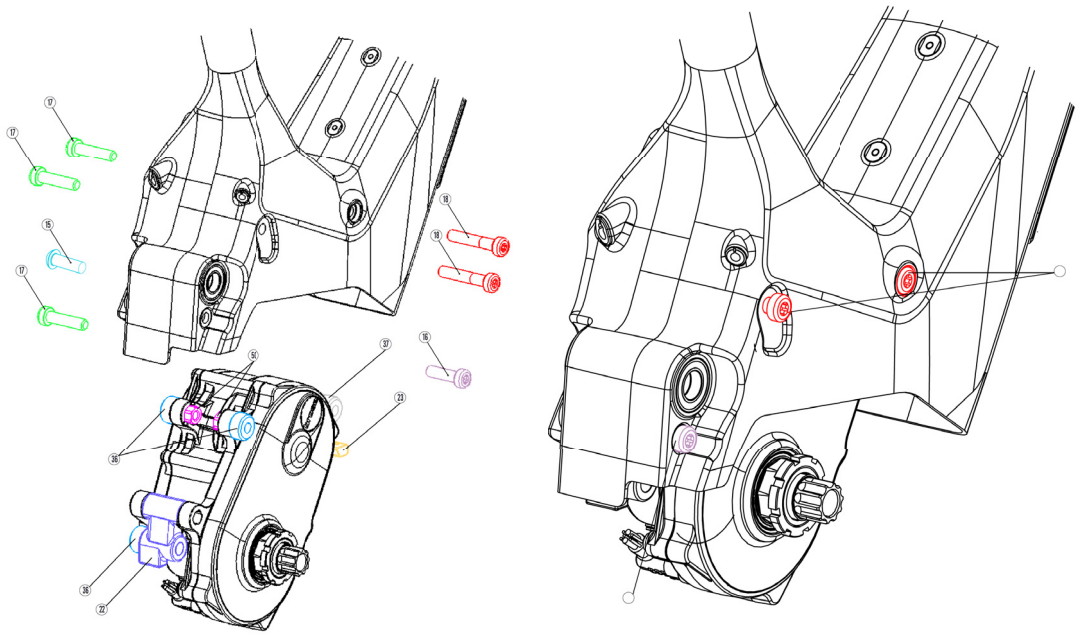

## SECTION 9 - SRAM POWERTRAIN COMPONENTS AND AFTERMARKET SMALL PARTS

The following is the SRAM Powertrain components installed to the Megawatt Carbon bike and available Aftermarket spares. If any of the parts installed to your bike develop an unlikely fault, please contact an authorised Nukeproof Dealer for warranty assistance. If any parts are damaged accidentally or the result of a crash, a SRAM dealer can assist with replacement parts as well as a Nukeproof Dealer.

### POWERTRAIN PARTS INSTALLED TO THE MEGAWATT CARBON

**PLEASE NOTE** - if changing chainring tooth count, the Powertrain system will need a software update to ensure Autoshift works correctly, please contact a Nukeproof or SRAM Dealer for firmware update.

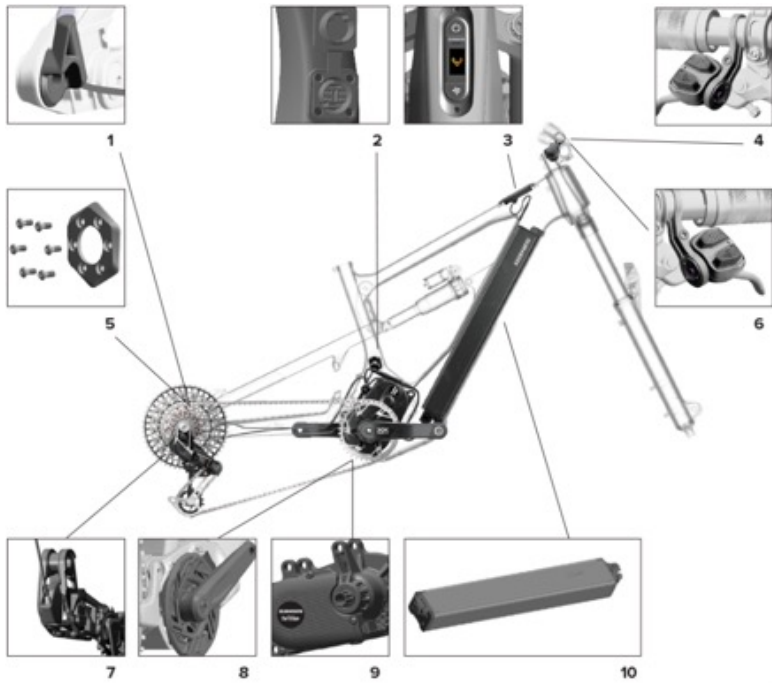



- 1 – Eagle Powertrain Speed Sensor
- 2 – Eagle Powertrain Charge Port
- 3 – Eagle Powertrain AXS Bridge Display
- 4 – Left AXS Pod Controller
- 5 – Eagle Powertrain Speed Ring (15mm rotor bolts required)
- 6 – Right AXS Pod Controller
- 7 – Eagle Transmission Derailleur + Eagle Powertrain Extension Cord
- 8 – Cranks
- 9 – Eagle Powertrain Drive Unit
- 10 – Eagle Powertrain Battery (720Wh)

## SPECIFIC PARTS INSTALLED TO RS AND PRO MODELS

---

Please reference the components on your bike for wear and tear replacement, crash damage replacement and servicing. Parts can be sourced via SRAM Dealers.

## PLEASE NOTE

---

Transmission T-Type parts regardless of model are cross compatible, this allows a mix of GX/XO/XX AXS T-Type transmission parts to be used on your Megawatt Carbon.

## RS

---

- **Drive System:** SRAM Eagle Powertrain Drive Unit, 250W, 90NM
- **Battery:** SRAM Eagle Powertrain Full Size, 720WH
- **Display:** SRAM Eagle Powertrain AXS Bridge Display
- **Crankset:** SRAM XO Eagle E-MTB, 160mm, XX 36T T-Type Chainring
- **Controls:** SRAM AXS POD Left & Right Bridge MMX
- **Rear Derailleur:** SRAM XO AXS, 12-Speed Eagle T-Type
- **Chain:** SRAM XO, 12-Speed Eagle T-Type, Flattop, PowerLock
- **Cassette:** SRAM XO, 12-Speed Eagle T-Type, CS XG1295 EAGLE 10-52T
- **Battery Charger:** Eagle Powertrain Charger EU/UK/US Plug Supplied

## PRO

---

- **Drive System:** SRAM Eagle Powertrain Drive Unit, 250W, 90NM
- **Battery:** SRAM Eagle Powertrain Full Size, 720WH
- **Display:** SRAM Eagle Powertrain AXS Bridge Display
- **Crankset:** SRAM GX Eagle E-MTB, 160mm, XX 36T T-Type Chainring
- **Controls:** SRAM AXS POD Left & Right Bridge MMX
- **Rear Derailleur:** SRAM GX AXS, 12-Speed Eagle T-Type
- **Chain:** SRAM GX, 12-Speed Eagle T-Type, Flattop, PowerLock
- **Cassette:** SRAM GX CS1275, 12-Speed T-Type, 10-52T
- **Battery Charger:** Eagle Powertrain Charger EU/UK/US Plug Supplied

## BATTERIES USED

---

- **AXS POD Batteries** – CR2032 Coin cell battery only.
- **Pedal Sensor Battery** – AAA Lithium/Iron Disulphide (Li/FeS<sub>2</sub>) battery only.
- **Main Powertrain Battery** –
  - **Model:** SRM-002-50SD
  - **Rated Capacity:** 19.6Ah
  - **Nominal Voltage/Energy:** 36.3Vdc/712Wh
  - **Max. Charge/Current:** 42V/4A
  - **Max. Discharge Current:** 22.5A

## PLEASE NOTE

---







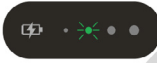

Transmission T-Type parts regardless of model are cross compatible, this allows a mix of GX/X0/XX AXS T-Type transmission parts to be used on your Megawatt Carbon.

## SECTION 10 - TROUBLESHOOTING & ERROR CODES

The following will help with diagnosing any unlikely faults with the Powertrain system. If the fault cannot be resolved, please consult with your Nukeproof Dealer.

### BATTERY

SRAM Powertrain battery fault codes are presented as a sequence of LED lights to assist diagnoses. A one second press of the battery button could result in any of the following sequences of flashing LEDs. If any of the sequences are shown, the battery and/or charger may have a critical fault. Reference the LED position and flashes per second to reference the fault and solution below.

	HOLD BUTTON 1 SECOND	RECOMMENDED SOLUTION
	LED Flash 2 Per Seconds - Low Voltage Protection	Using SRAM Powertrain charger, charge the battery.
	LED Flash 2 Per Second - High or Low Temperature Protection	Move SRAM Powertrain Battery to room temperature location.
	LED Flash 2 Per Second - Short Circuit Protection	Remove battery from the bike. Check battery and cable for obstructions. Clean and remove short circuit objects with a non-conductive tool.
	Slow flash all LEDs 1 Per Second - Long Term Battery Use/Battery Health Poor	Contact your Nukeproof Dealer for a Battery Health Check.
	LED Flash 2 Per Second - Safety Protection	Immediately stop riding or charging. For a period of 30 minutes please let the battery rest. Contact your Nukeproof Dealer for a Battery Health Check if fault returns after rest period.
	LED Flash 2 Per Second - Battery Protection or Safety Protection	Immediately stop charging and contact your Nukeproof Dealer for a Battery Health Check.
 	LED Alternative Flash 2 Per Second <ul style="list-style-type: none"> <li>No communication between Powertrain Battery and SRAM Charger - Or</li> <li>Overcurrent Protection</li> </ul>	Remove battery from the bike. Check battery and cable for obstructions. Clean and remove short circuit objects with a non-conductive tool.

## LOW POWER MODE



When your battery reaches 3% charge, the bike will automatically enter Low Power Mode. This will reduce the assistance from the drive unit. This is a standard operation of the Powertrain system to support your ride until the battery reaches Saver Mode. Powertrain will reserve a small amount of power to ensure Eagle Transmission Rear derailleur can still operate. The Low Power Model display will auto dismiss after 10 seconds, and Bridge Display will revert to the home screen.

If the battery detects high or low temperatures, the Powertrain will enter Low Power Mode Temperature mode. Powertrain will reduce power to the drive unit until the battery reaches a safe operating temperature range of 0°C (32°F) to 60°C (140°F). This is standard operation of the Powertrain system and Powertrain will reserve a small amount of power to ensure Eagle Transmission Rear derailleur can still operate.

## ERROR MESSAGES

The Powertrain Bridge Display on the Megawatt Carbon top tube will also display error messages. Follow the instructions on the Bridge Display or connect your SRAM AXS app to view errors and follow the AXS app instructions to remedy the fault. If the displayed fault persists, please contact your Nukeproof Dealer for further assistance.

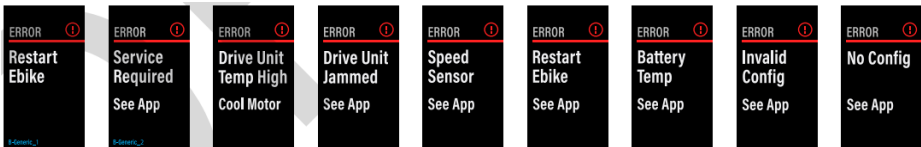

## SECTION 11 - WARNINGS

### MINIMUM SEAT POST INSERTION

---

The seat post installed to your bike will have a minimum insert line, do not exceed this line. Exceeding the minimum insert can lead to post and frame damage. If you need the saddle higher than the insert level allows, please consult with your dealer regarding frame sizing or a longer post. Damage to a seat post or frame caused by not adhering to the minimum insert line is not covered by warranty.

### MAXIMUM TYRE WIDTH

---

Do not exceed the fork and frame maximum tyre widths. The frame is designed to accept a tyre up to 2.6" and the fork's maximum tyre widths are detailed below. Please note some manufacturer tyre and rim combinations can be wider when fitted together, always check for clearance when tyres are changed to a different model. Tyre rub can damage frame and will not be covered by warranty if incorrect tyre size has been used.

- RockShox ZEB max tyre clearance 2.8"

### MAXIMUM AXLE TO CROWN AND TRAVEL OF FORK

---

The fork length also detailed as axle-to-crown (A-C) cannot be exceeded. Maximum A-C for the Megawatt Carbon is 596mm. Using a fork that exceeds the A-C may lead to frame failure and injury. Using a longer axle to crown fork will void warranty. The bike is designed with a 170mm fork in mind, though a 180mm fork can be used as long as the A-C is not exceeded. A dual crown/triple clamp fork cannot be installed to the Megawatt Carbon.

### DIRECT SUNLIGHT AND HEAT

---

Try to avoid exposing your bike to direct sunlight and excessive heat, this can damage the paint and fatigue plastic components.

### RIDER WEIGHT

---

Nukeproof bikes are designed and tested to ISO 4210 / EN17404 standards. Our bikes conform to the load tolerance of 120kg the standards require. If the user is over this weight when kitted, we would recommend regular inspection and maintenance to avoid issues and expect wear and tear parts to be replaced more often. Third-party components may have different load and weight standards, any concerns with components weight limits please consult with your Nukeproof Dealer. We cannot guarantee the integrity of the bike and its components if the user is over 120kg.

## LOOK AFTER YOURSELF

---

Always wear a helmet that meets legal safety standards when riding your Megawatt and additional protective equipment when required. Ensure you are riding your bike in accordance with local laws, with protective equipment, reflectors and lights installed when and where required.

## ON ROAD RIDING

---

- Ensure all local traffic laws are obeyed when using your bike on-road.
- Respect all other road users' journeys.
- Ride safely and be prepared for actions of other road users or road conditions that may jeopardize your safety or safety of other road users.
- Do not allow yourself to be distracted while cycling on-road.
- Carry maintenance tools and spares to ensure you can complete your ride if a mechanical was to occur

## OFF-ROAD RIDING

---

- Off-road riding can be dangerous with a variety of terrain, conditions, and hazards. Please ensure you have developed the adequate skill levels for the terrain you are riding and confident in your off-road abilities. Please get familiar with your bike, its handling, and capabilities before riding off-road.
- Ensure the location you are riding is legal, you have a right to ride there and no laws are being broken.
- Ensure you are wearing the appropriate safety equipment.
- Ride in groups to ensure your safety and make someone aware of your route and location.
- Carry maintenance tools and spares to ensure you can complete your ride if a mechanical was to occur.
- Be respectful and courteous to other off-road users, respect their journey.
- Be courteous to wildlife and the natural environment.
- Stay on designated trails to avoid unnecessary erosion.

## RIDING AT NIGHT

---

Be cautious when riding at night, riding at night can be more hazardous than daytime. At night a rider is harder to see by drivers and pedestrians, ensure you are wearing brighter clothing with reflective features. Please ensure you use reflectors and lights on your bike and these comply with local laws. Reflectors are not a suitable alternative to lights; lights must be used along with reflectors at night. Ensure reflectors and light mounts are of sound condition and secure. Ensure lights are charged or the lights method of power is working adequately, ensure there is enough power for the duration of your journey.

## WET WEATHER RIDING

---

In wet weather conditions please ensure you are riding within your skill level and experience. Wet weather can reduce surface grip, reduce tyre traction, reduce visibility, and reduce braking performance. Contact points on the bike may have reduced grip, these include handlebar grips, brake levers, pedals, saddle, and shifters. Please consider these factors when riding in the wet to avoid loss of control and potential injury. Please ensure adequate wet weather clothing is used. Gloves and shoes suitable for wet weather riding will help with using the bikes controls and maintaining grip on the pedals.

## BATTERY RECYCLING

---

Please check local legislation in regard to battery disposal and recycling. Not following local legislation for battery disposal and recycling could result in prosecution. Do not dispose of batteries with general domestic waste, recycling correct in line with local regulations will help with environmental preservation.

## BATTERY SAFETY

---

If there are any doubts with the handling of the battery or bikes electronic systems, immediately cease and contact your Nukeproof Dealer.

### HANDLING THE BATTERY

- Use the specified SRAM battery charger for charging. Doing otherwise may cause overheating, bursting, reduced lifespan, or ignition.
- Be mindful not to leave the battery near heat sources such as heaters or direct sunlight. Doing so may cause bursting or ignition.
- Never heat the battery or dispose into a fire. Doing so may cause bursting or ignition.
- Do not manipulate, modify, disassemble, or open the battery. Doing so may cause leaks, overheating, bursting, or ignition.
- Do not connect the battery terminals with metallic or any conductive objects. A short circuit may occur or overheat and result in fire, property damage or injury.
- Do not transport or store the battery with metallic objects such as tools. Doing so, a short circuit may occur or overheat and result in fire, property damage or injury.
- Do not place the battery into any water or liquid, also be cautious not to get the battery terminals wet. Doing otherwise may cause it to overheat, burst, or ignite.
- Do not throw or subject the battery to large direct impacts. Doing so may cause damage leading to overheating, bursting, or ignition.
- Ensure to charge your battery in a location that is visible and within range of smoke/fire detectors.
- Once the battery comes to the end of its service life, please dispose/recycle the battery in accordance with your local regulations.
- Never use a pressure washer on your battery, this may cause ingress of water.
- In the unlikely event of a fire, use an electrical certified fire extinguisher or fire blanket and notify emergency services. Do not use water.
- Do not use the supplied 720Wh battery outside of the stated operating temperature range. Failure to comply to the operational range fire, injury or system errors may occur.
  - During discharge:  $-10^{\circ}\text{C}$  -  $+40^{\circ}\text{C}$
  - Storage  $-10^{\circ}\text{C}$  -  $+40^{\circ}\text{C}$
  - Charge  $-0^{\circ}\text{C}$  -  $+40^{\circ}\text{C}$

### HANDLING THE CHARGER –

Avoid allowing the battery charger to become wet. If water is allowed to ingress inside the charger, this could cause fire, overheating, electric shock injury or damage to property.

- If the charger has become wet, do not touch, or hold the charger. Do not touch the charger with wet hands. An electric shock may occur.
- Do not use wrap or cover the battery charger in any material. Doing so may cause excessive heat to accumulate, causing failure of parts, deformation, fire, ignition, or overheating.
- Do not dismantle or make modifications to the battery charger. If this is not observed, electric shocks, injury or fire may occur.
- The battery charger must be used at the specified power supply voltage only. Using an alternative power supply voltage other than that specified is used, fire, destruction, smoke, overheating, electric shocks or burns may occur.
- Only use SRAM Powertrain Charger with your bike, using alternative chargers may result in fire, injury, property damage, reduce service life of battery and components.

## TRANSPORTING YOUR BIKE

---

- Remove your battery and store safely when travelling with your bike.
- It is recommended not to carry your bike on the outside of your vehicle during rain unless protected/covered. SRAM Powertrain components are protected from water but travelling at speed can cause water ingress.
- Check if there is any local battery restrictions or regulations while travelling by vehicle.
- If flying with bike, please check battery policies with airlines and airports.



## SECTION 12 - WARRANTY

The warranty covers the original purchaser from defects in materials, paint and workmanship from the original purchase date for a period as listed below:

- Megawatt carbon frame – 5 years
- Nukeproof Horizon v2 carbon bars - lifetime
- Nukeproof components – 2 years
- SRAM components & Powertrain – 2 years
- Anything else – as per manufacturer warranty periods

### **PLEASE NOTE**

Transfer of the item from the original purchaser to another person terminates this limited warranty. A proof of purchase is required to validate the warranty period.

Where Nukeproof repair or replace items under warranty, the cover for these items is limited to the original warranty period and subject to the conditions outlined in the original warranty.

This limited warranty does not cover items used in rental operations or any defect caused by wear and tear, accident, neglect, improper handling, abuse, misuse, improper assembly, incorrectly performed maintenance or repairs, non-compliance with recommended manufacturers maintenance and care procedures.

NB: Bearings that fail due to contamination, misuse, improper, or lack of maintenance are not covered under warranty even if failure occurs within a short time from date of purchase. Water ingress from power washing will invalidate this warranty. Damaged threads due to incorrect fitment are not covered by a manufacturer's warranty. For example. Damage to crank arms from incorrectly fitted pedals.

### **CONSEQUENTIAL LOSS**

Nukeproof is not responsible for direct, incidental or consequential damages resulting from any breach of warranty or condition or under any other legal theory, including but not limited to loss of use, loss of revenue, loss of actual or anticipated profits (including contracts) loss of the use of money, loss of anticipated savings, loss of business, opportunity, goodwill, reputation, any indirect or consequential loss.



