



Luxury Dual Hoops Electronic Basketball Game Assembly Instructions



 READ AND FOLLOW ALL ASSEMBLY, OPERATION AND SAFETY INSTRUCTIONS CAREFULLY.

WARNINGS! CHOKER HAZARD - THIS TABLE CONTAINS SMALL BALLS AND PARTS NOT SUITABLE FOR CHILDREN UNDER 3 YEARS OF AGE.

DGBB01

HARDWARE IDENTIFIER

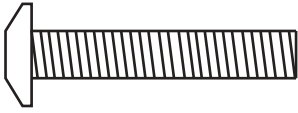

H1 - M6 x 35mm

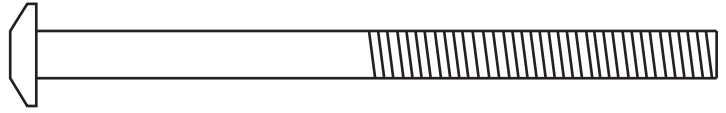

H2 - M6 x 90mm

Phillips Head Bolt
(1 pc)

Phillips Head Bolt
(2 pcs)

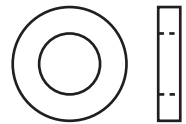
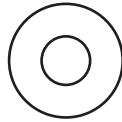
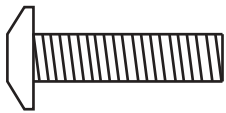

H3 - M6 x 25mm
Phillips Head Bolt
(16 pcs)

H4 - M6 x 15mm
Flat Washer
(3 pcs)

H5 - M6
Wing Nut
(19 pcs)

H6 - Plastic
Bushing
(2 pcs)



H7 - M6
Lock Washer

(16 pcs)

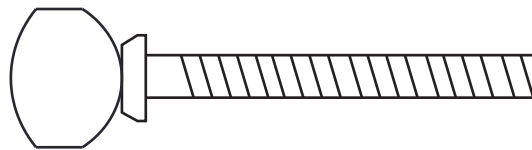

H8 - Plastic
Wing Bolt to
attach P17
Control Box
(1 pc)



T1 - Phillips
Allen Wrench
(1 pc)

PARTS IDENTIFIER

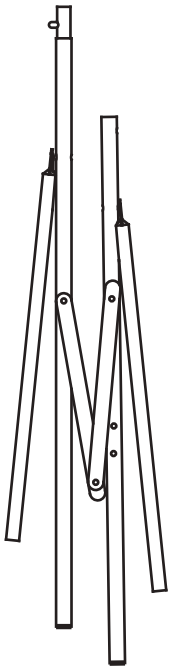

P1 - Left Lower
Tube Assembly
(1 pc)

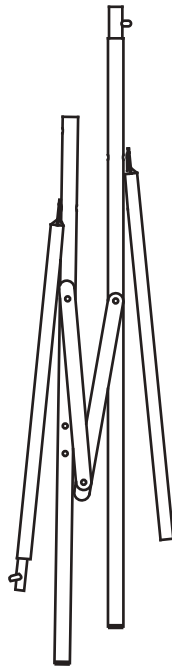

P2 - Right Lower
Tube Assembly (1
pc)



P3 - Left Middle
Tube Assembly
(1 pc)

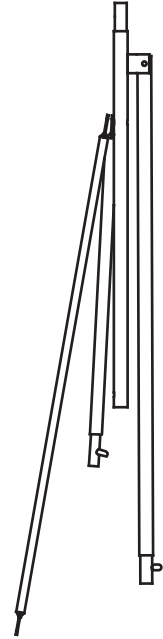

P4 - Right Middle
Tube Assembly
(1 pc)

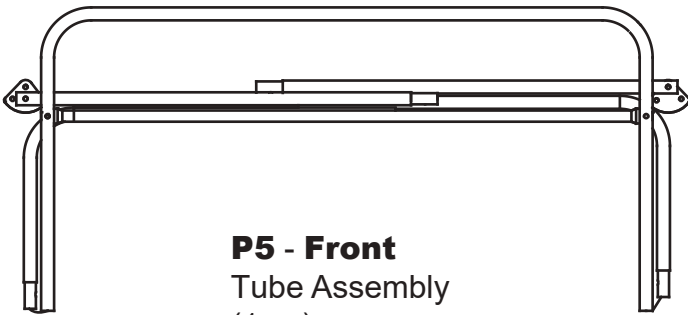

P5 - Front
Tube Assembly
(1 pc)

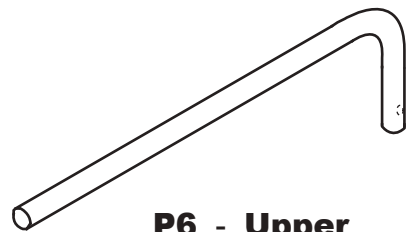

P6 - Upper
Tube (2 pcs)

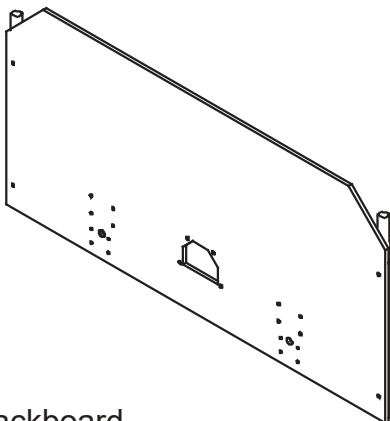

P7 - Backboard
with Tubes Assembly
(1 pc)

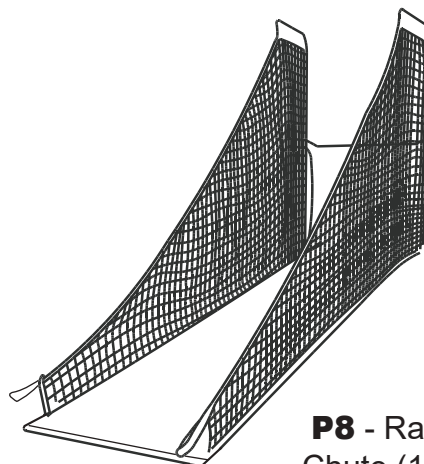

P8 - Ramp
Chute (1 pc)

PARTS IDENTIFIER

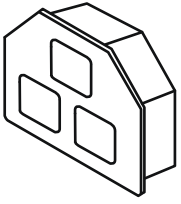

P9 - Electronic Scorer (1 pc)

3 pcs AA Batteries Required ,
Not Supplied

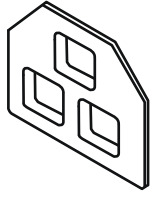

P10 - Electronic Scorer Face Plate (1 pc)



P11 - Mechanical Scoring Arm (2 pcs)

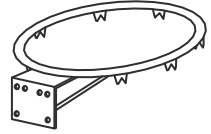

P12 - Rim (2 pcs)
Note: This is a special rim designed to avoid entanglement with the mechanical scoring arm.

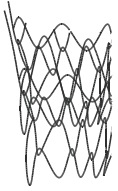

P13 - Rim Net (2 pcs)

Note: This is a special rim net designed to avoid entanglement with the mechanical scoring arm.

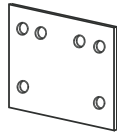

P14 - Rim Support Plate (2 pcs)



P15 - Locking Pin (2 pcs)



P16 - Scoring Control Box Wire (1 pc)

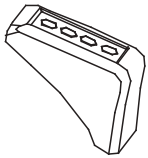

P17 - Control Box (1 pc)

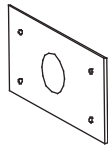

P18 - Mechanical Scoring Arm Support Plate (2 pcs)

ACCESSORY IDENTIFIER



A1 - Air Pump with Needle (1 pc)

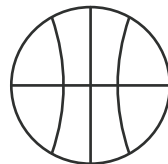

A2 - Basketball (5 pcs)

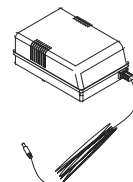

A3 - A/C Adapter (1 pc)



STEP 1

Connect **P2 - Right** Lower Tubes Assembly to **P1 - Left** Lower Tubes Assembly using Spring Lock as shown in **FIGURE 1**.

FIGURE 1

WARNING / PINCH HAZARD!
Keep hands and fingers away from hinge until STEP 3 is complete and the hinge is in a controlled position.

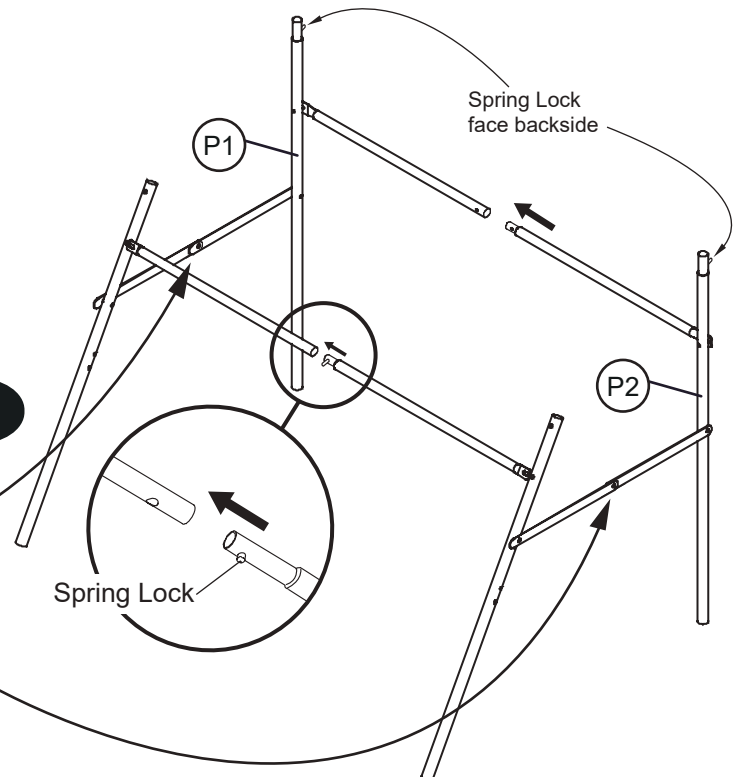

STEP 2

Connect **P4 - Right** Middle Tubes Assembly to **P3 - Left** Middle Tubes Assembly using Spring Lock as shown in **FIGURE 2**.

NOTE: The only assembly in this step is connecting this spring lock.

FIGURE 2

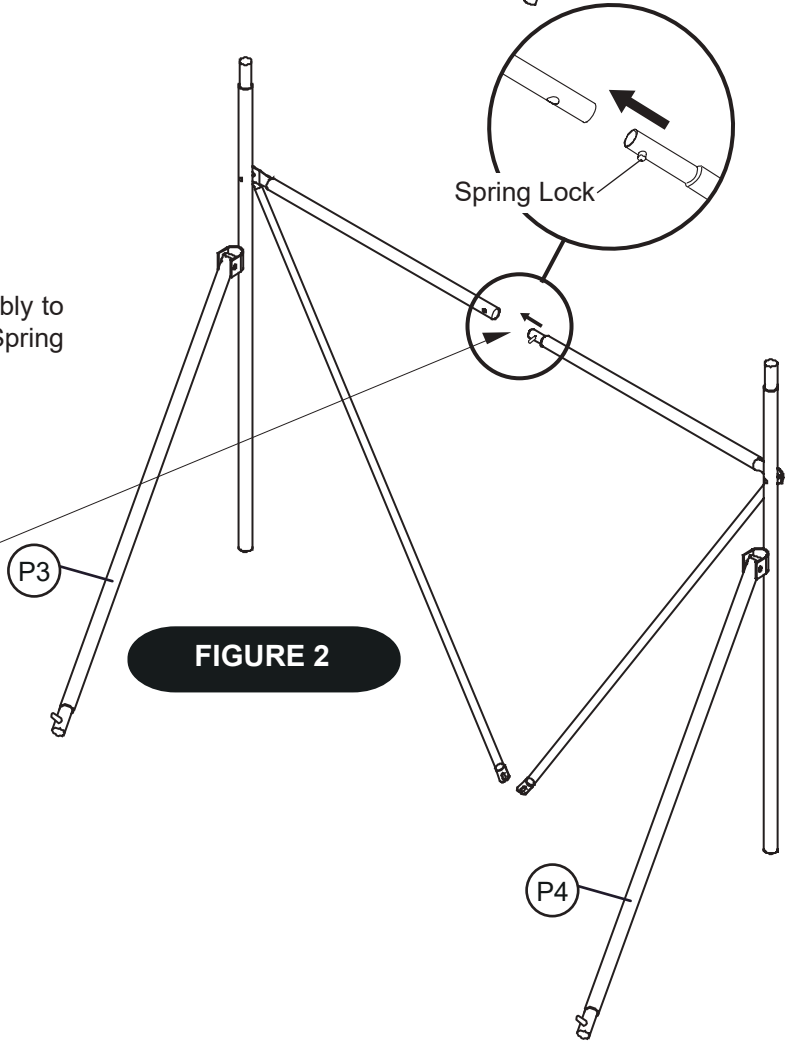

STEP 3

Connect Middle Tubes Assembly from **STEP 2** to Lower Tubes Assembly from **STEP 1** using Spring Locks. Next, using **H1 Bolt**, **H4 Washer** and **H5 Wing Nut** connect frame braces as shown in **FIGURE 3** and **DETAIL A**.

NOTE: Lastly, these six points can now be tightened using a phillips screwdriver or Phillips Allen Wrench (T1) provided and pliers.

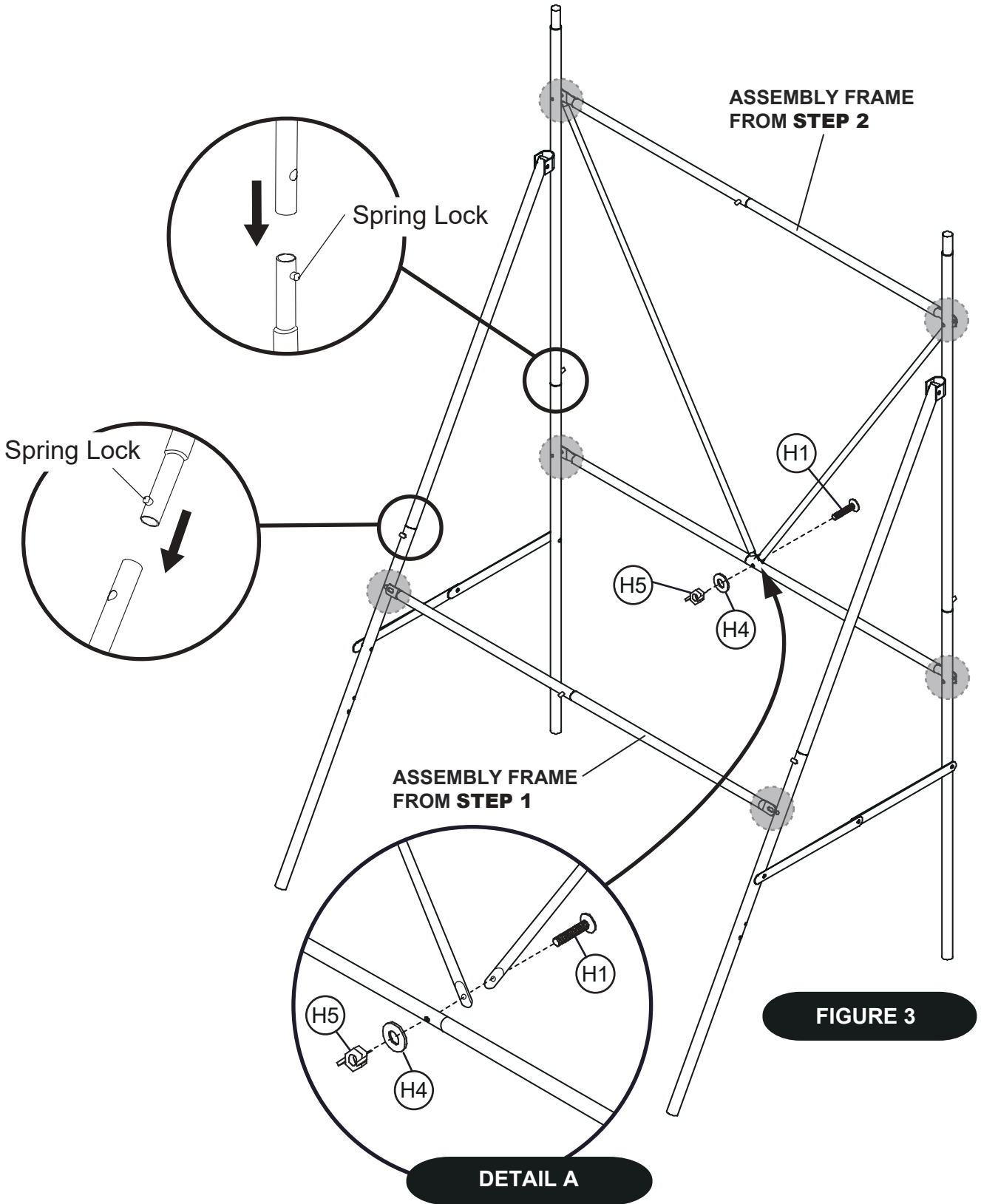

FIGURE 3

DETAIL A

STEP 4

Connect **P5** Front Tube Assembly using Spring Lock as shown in **FIGURE 4**.

NOTE: Bungee Cord is an assembly aide and stays in place.

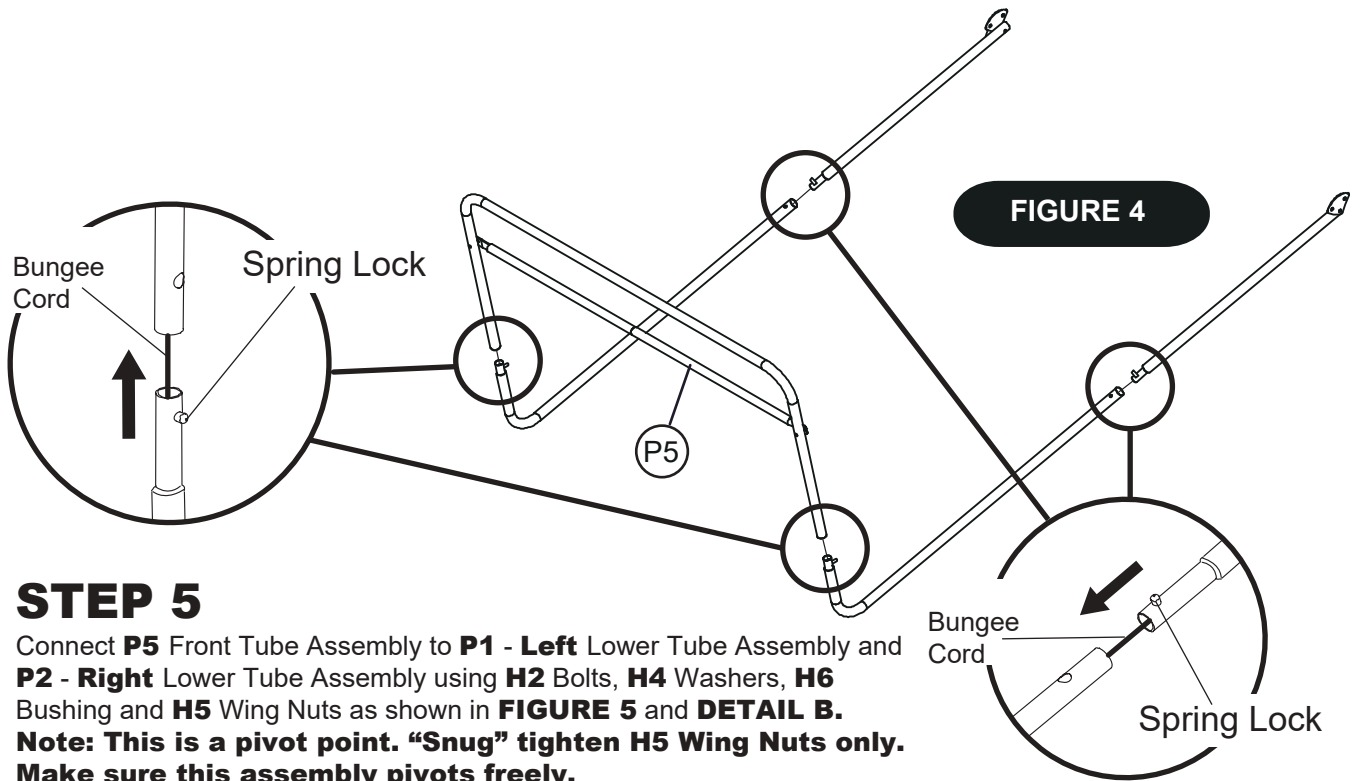

STEP 5

Connect **P5** Front Tube Assembly to **P1 - Left** Lower Tube Assembly and **P2 - Right** Lower Tube Assembly using **H2** Bolts, **H4** Washers, **H6** Bushing and **H5** Wing Nuts as shown in **FIGURE 5** and **DETAIL B**.

Note: This is a pivot point. "Snug" tighten **H5** Wing Nuts only. Make sure this assembly pivots freely.

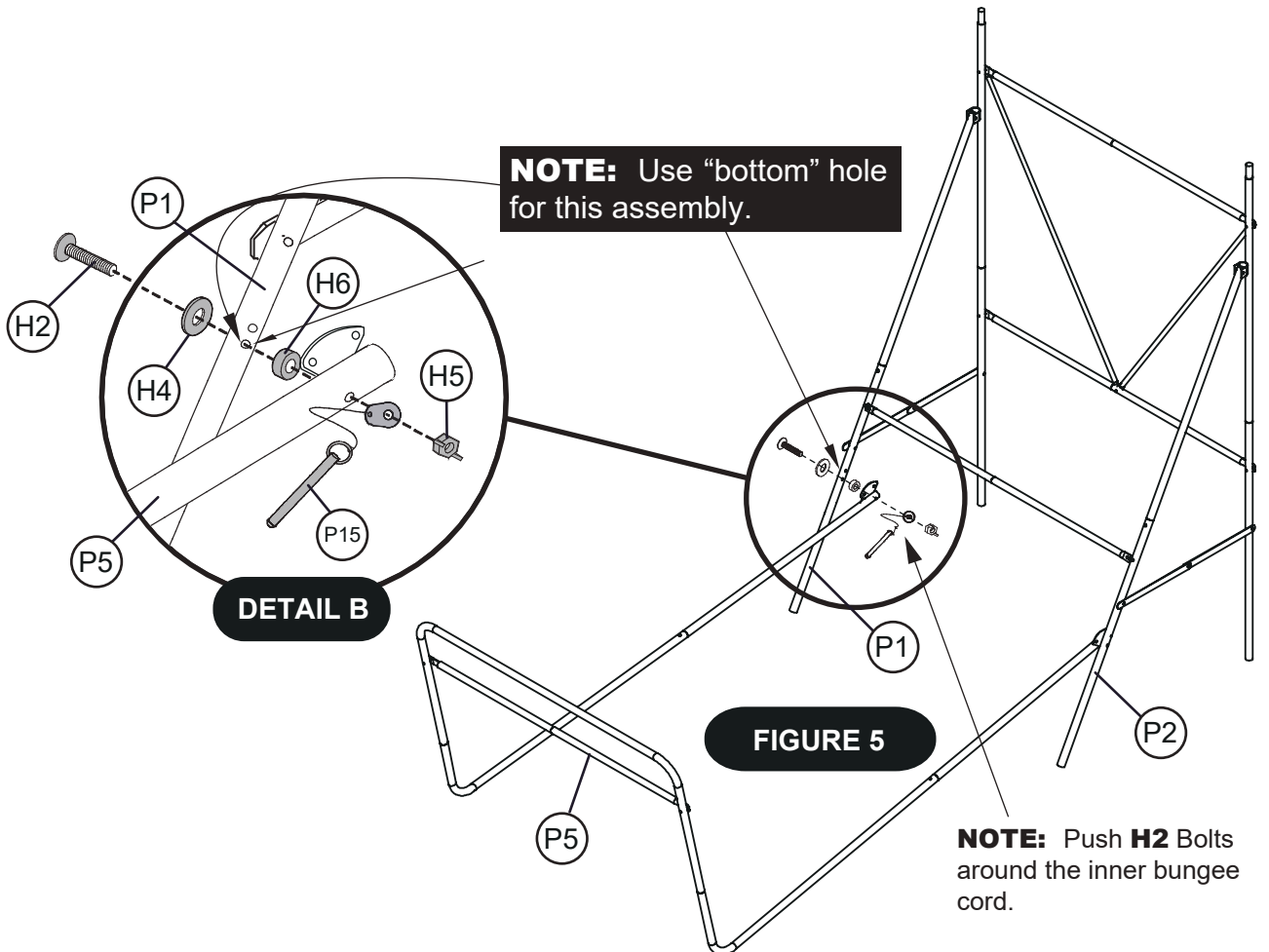

STEP 6

Attach **P12** Rim and **P14** Rim Support Plate to the **P7** Backboard using **H3** Bolts, **H7** Lock Washers and **H5** Wing Nuts as shown in **FIGURE 6**.

Attach **P11** Mechanical Scoring Arms and **P18** Mechanical Scoring Arm Support Plates to the **P7** Backboard using **H3** Bolts, **H7** Lock washers and **H5** Wing nuts as shown in **FIGURE 6**.

Use T1 Phillips Allen Wrench and Pliers (not provided) to tighten all Bolts.

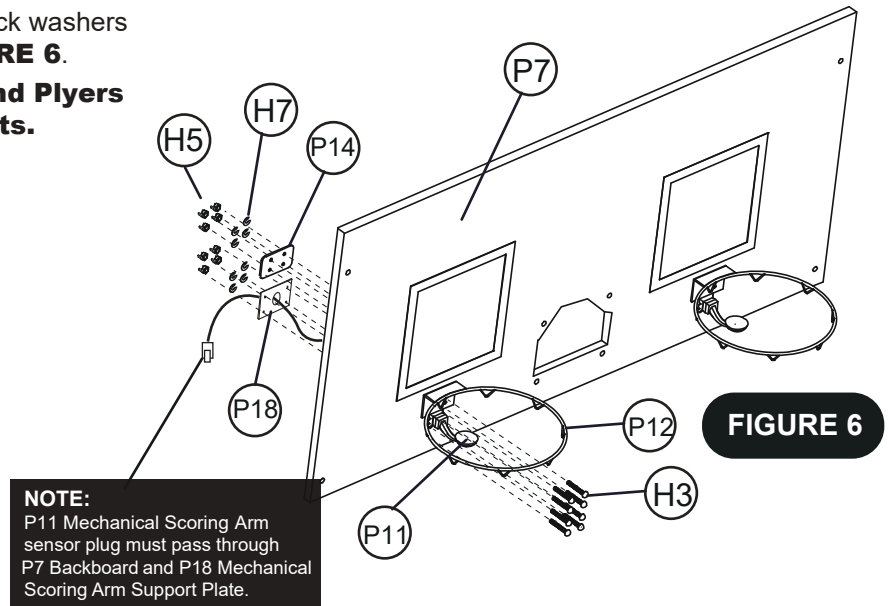

STEP 7

Attach **P9** Electronic Scorer and **P10** Electronic Scorer Face Plate to **P7** Backboard as shown in **FIGURE 7**.

NOTE: Place **P10** Electronic Scorer Face into **P7** Backboard first, then carefully “press” **P9** Electronic Scorer onto the four tabs on **P10**. **You should hear the four tabs “snap” into place.**

Loop the **P13** Rim Net through the ram horns on the **P12** Rims as shown in **FIGURE 7**.

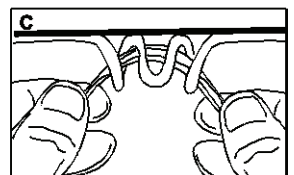
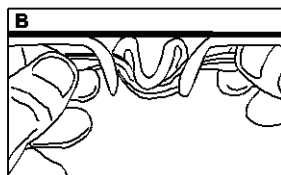
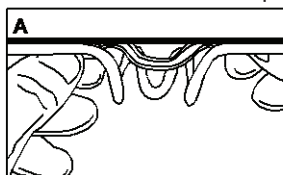
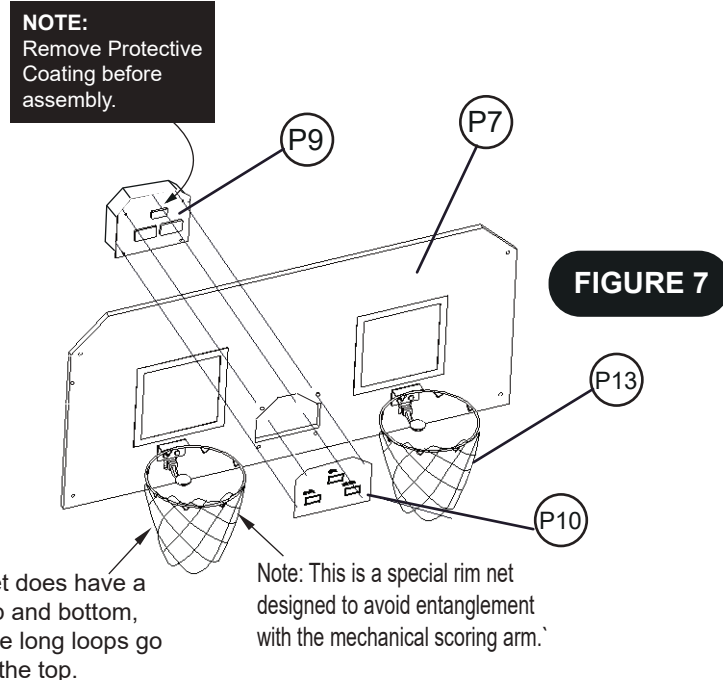

STEP 8

Attach Backboard assembly from **STEP 7** to Frame assembly from **STEP 5** as shown in **FIGURE 8**.

Attach **P6** Upper Tubes to **P7** Backboard assembly using Spring Lock as shown in **FIGURE 8**.

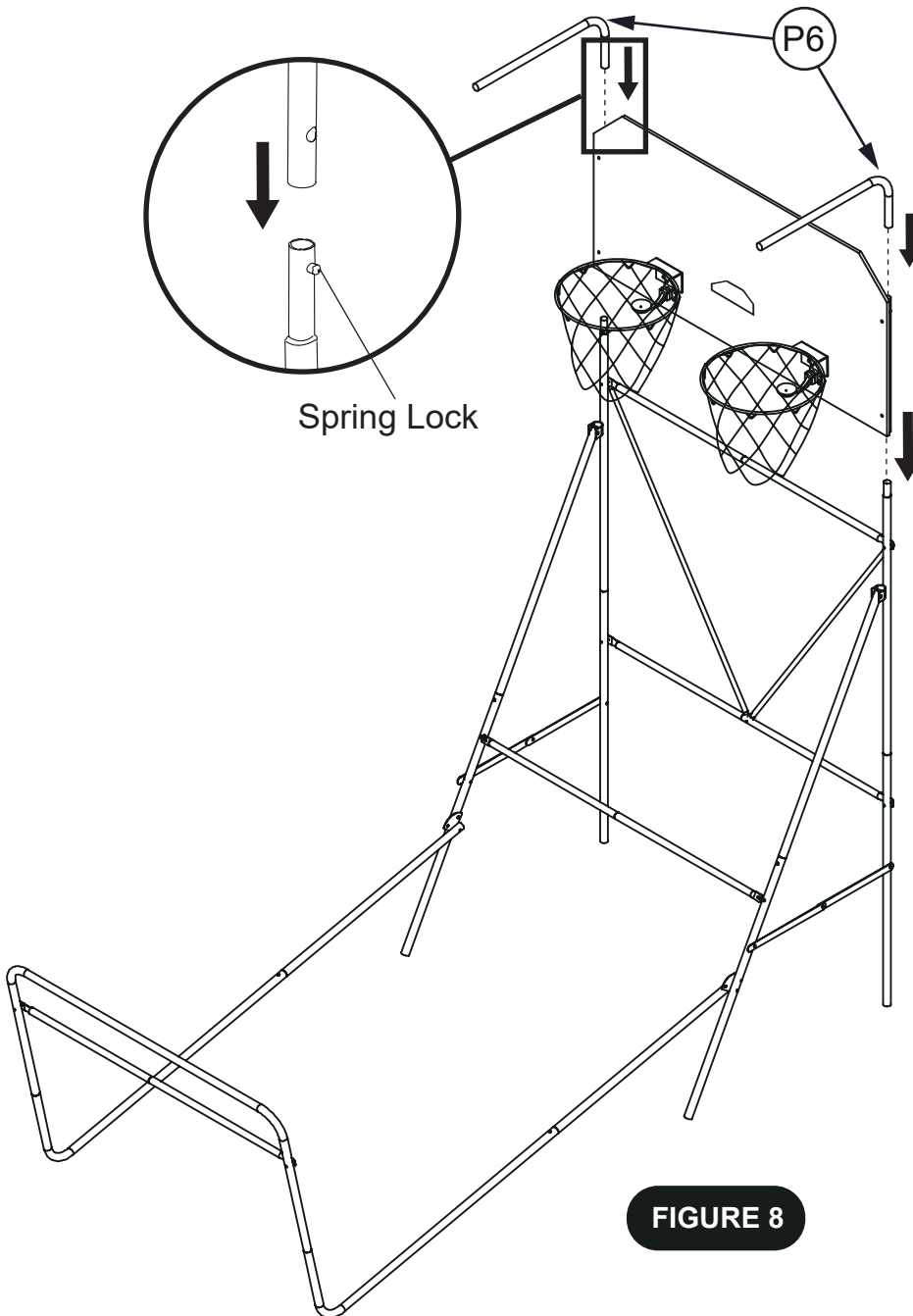
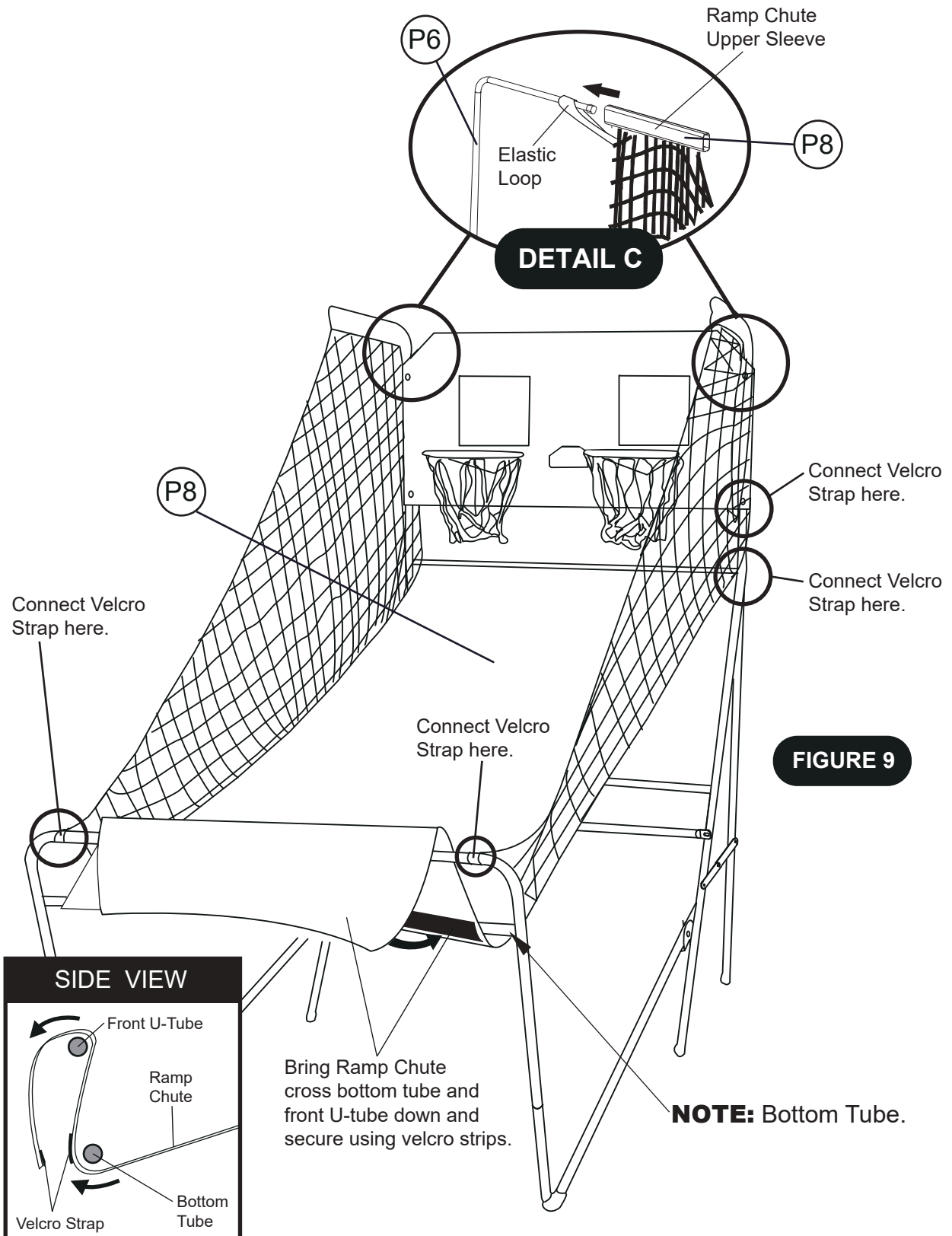

FIGURE 8

STEP 9

Slide elastic loops and the sleeve of **P8** Ramp Chute onto **P6** Upper Tubes as shown in **FIGURE 9** and **DETAIL C**.

At the front of **P8** Ramp Chute, bring the ramp down and secure using velcro strap as shown in **FIGURE 9**. Secure all velcro straps on the shootout as shown in **FIGURE 9**.



STEP 10

Connect **P11** Mechanical Scoring Arm sensor wires to **P9** Electronic Scorer as shown in **FIGURE 10**. Secure Elastic Loops from **P8** Ramp Chute to the back of **P7** Backboard attached Wing Nuts as shown in **FIGURE 10**.

Hook Elastic Loops over Wing Nuts in six locations as shown in FIGURE 10.

Connect **P16** Scoring Control Box Wire to **P9** Electronic Scorer as shown in **FIGURE 10** and **DETAIL D**.

Now attach **P17** Control Box to the right corner of the front U-Tube **P5** using **H8** Wing Bolt as shown in **FIGURE 11**. Run the rest of **P16** Control Wire through the loops on **P8** Ramp Chute.

This game has a Dual Power feature. You can insert 3 AA Batteries (not included) into the battery compartment on the back of the Electronic Scorer **P9**--- OR --- use the A/C Adapter **A3** (provided) when your shootout is close to a power source. Please remove the batteries when you are using the A/C Adapter.

See " **FIRST TIME BATTERY INSTALLATION AND NOTICE** " , before installing batteries, located on **page 17**

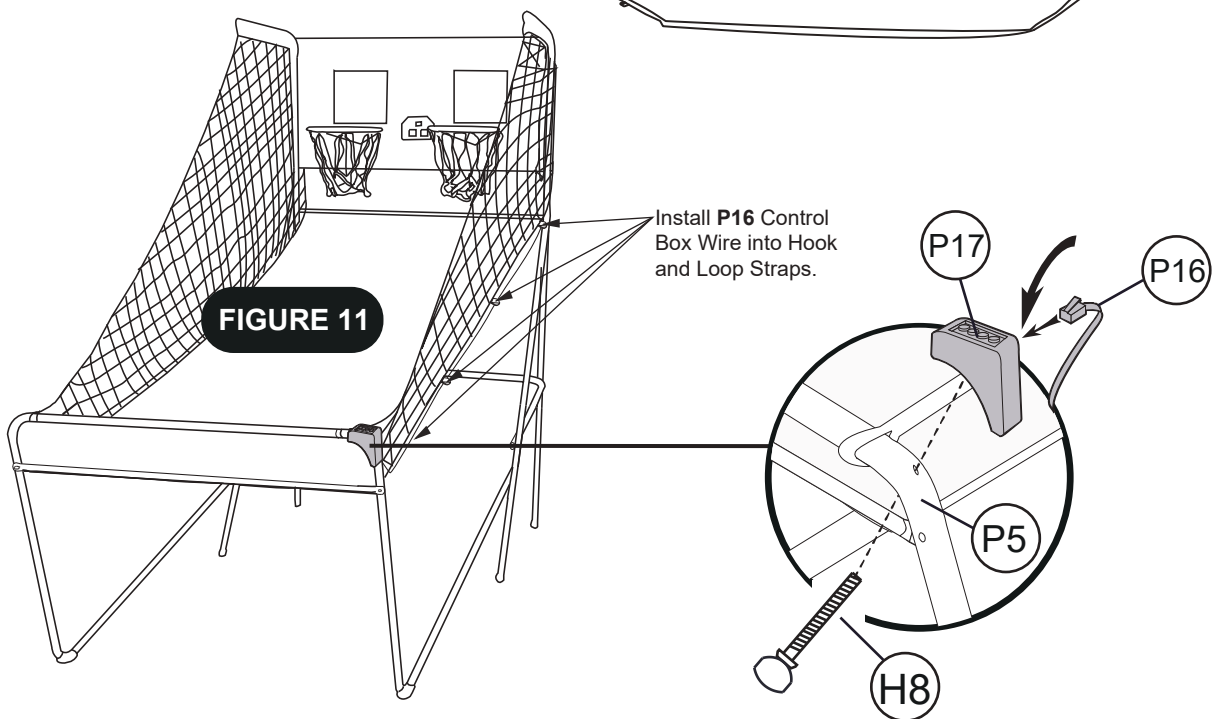
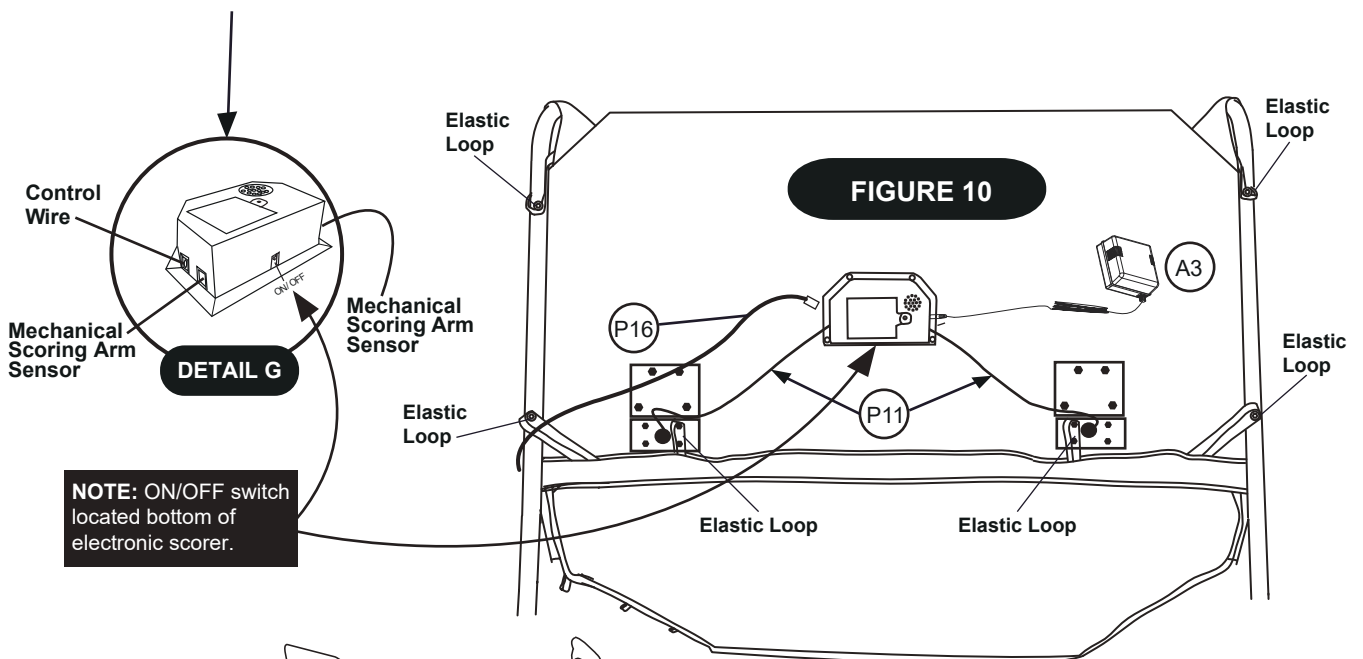

4. Horse

- a. Press "PLAY" to enter game.
- b. Press "UP/Down" to select multiple players (P2/P3/P4)
- c. Press "PLAY" after the number of player is selected
- d. Player has to make a shot in 2 seconds.
- e. First player is allowed to shoot at any hoop (Home or VISITOR). If first player scores in 2 seconds, no letter is given. Game continues for next player. Scoreboard will display "next player(P2P3/P4)" and LED will flash twice in a second. After flash, next player has to duplicate the shot in the same hoop selected by first player.
- f. If player can't score in 2 seconds, player receives the first letter "H" which will display on scoreboard. Game remains for the same player until the player scores. If player keeps missing, player receives "O" followed by "R", "S", "E". The letter "E" is given, the player is out.
- g. The first player to spell "horse" loses. Players stay in repeat step d.e.f. till game is finished
- h. The last player to spell "horse" wins
- i. Press "PLAY" to restart this game

5. Check Point

Press "PLAY" to enter game 5.

Press "UP/Down" to select single/multiple players (P1/P2/P3/P4).

Press "PLAY" to begin the game.

"HOME" displays "player", "VISITOR" displays "24" points, pre-set 40 seconds playing time.

Points scored will display on scoreboard "HOME"

Before time is out, once 24/52/68/86 points is scored, playing time increases 10/20/10/20 seconds respectively

Countdown 5 seconds to next player's turn when one player finishes game

Player with more points scored wins (LED will flash on player with higher score)

Game is finished when a player scores 99 points

Press "PLAY" to restart this game

6. Around the World

Use tape to mark the shooting lines.

Press "PLAY" to enter game 6.

Press "UP/Down" to select single/multiple players (P1/P2/P3/P4).

Press "PLAY" after the number of player is selected.

Scoreboard "HOME" displays Player 1/2/3/4, "VISITOR" displays scored points.

Once score comes to 14 points or time comes to 99 seconds countdown 5 seconds to next player's turn when one player finishes game.

Player who finishes the game first wins (LED will flash on winner).

Press "PLAY" to restart this game.

7. Left and Right shoot

Press "PLAY" to enter game 7.

Press "UP/Down" to select single/multiple players (P1/P2/P3/P4).

Press "PLAY" after the number of player is selected.

Press "UP/Down" to select playing time, 30/45/60 seconds.

Press "PLAY" to begin the game.

Scoreboard "HOME" displays Player, "VISITOR" displays points.

Make a shot in "HOME" frame when LED is flashing on "HOME", 2 points scored display on "HOME".

Make a shot in "VISITOR" frame when LED is flashing on "VISITOR", 2 points scored display on "VISITOR".

Countdown 5 seconds to next player's turn when one player finishes game.

Player with more points scored wins (LED will flash on player with higher score).

Press "PLAY" to restart this game.

8. One to One

Press "PLAY" to enter game 8.

Press "UP/Down" to select playing time, 30/45/60 seconds.

Press "PLAY" to begin the game.

Shot made in "HOME" frame, 2 points scored for "HOME", all shots count 3 points in last 10 seconds.

Shot made in "VISITOR" frame, 2 points scored for "VISITOR", all shots count 3 points in last 10 seconds.

Player with more points scored wins when time is out.

Press "PLAY" to restart this game.

ELECTRONIC SCORER OPERATION

1. Unscrew bolt using a screwdriver and open the battery box. Insert 3 AA batteries (not included) in the order of polarity as shown on the inside cover. Then close the cover using a screwdriver. Turn the power ON using the ON/OFF switch. (if the game will not be used for a long period of the time, we recommend that the batteries should be removed).

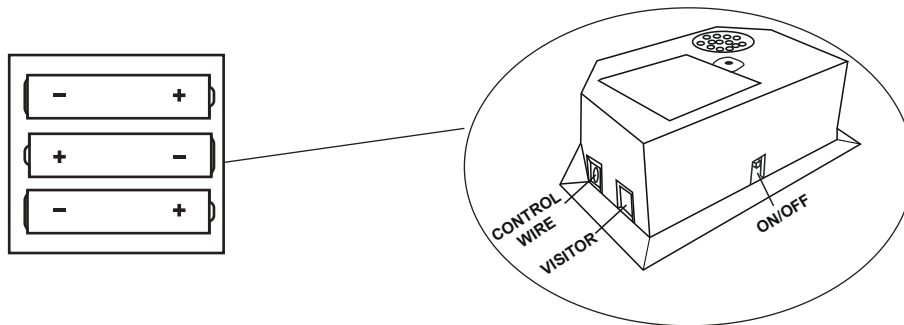

CONTROL BOX OPERATION

- Press "ON/OFF" to activate the scorer.
Scoreboard "HOME" shows "01" (pre- set game 1).
Press "SELECT UP and DOWN" to select a game.
Press "SELECT UP and DOWN" to enter selected game mode.
Press "SOUND" to switch sound ON/OFF while playing.
Press "PAUSE" to pause or start time counting.
Press and hold the button "ON/OFF" 3 seconds to turn off scorer.
Press and hold the button "RESET" 3 seconds to reset the games.

CONTROL PANEL

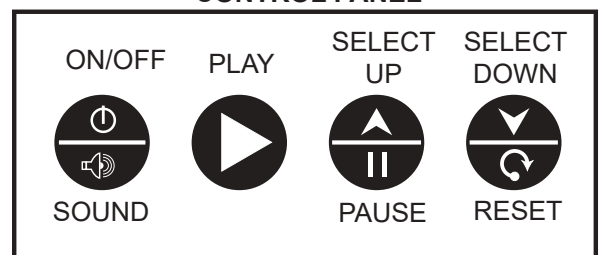

Note: If no shot is made or no button is pressed in 15 mins, scorer will be turned off automatically.

CHOOSE FROM 8 DIFFERENT GAME OPTIONS

1. Beat the time Clock

- Press "PLAY" to enter game 1.
Press "UP/Down" to select single/multiple players (P1/P2/P3/P4).
Press "PLAY" after the number of player is selected.
Press "UP/Down" to select playing time, 30/45/60 seconds.
Press "PLAY" to begin the game.
Scoreboard "HOME" shows Player 1, 3; Scoreboard "VISITOR" shows Player 2, 4.
All shots worth 2 points until last 10 seconds, each score counts 3 points.
Countdown 5 seconds to next player's turn when one player finishes game.
Player with more points scored wins (LED will flash on player with higher score).
Press "PLAY" to restart this game.

2. 3 Point Beat the Time Clock

- Press "PLAY" to enter game 2.
Press "UP/Down" to select single/multiple players (P1/P2/P3/P4).
Press "PLAY" after the number of player is selected.
Press "UP/Down" to select playing time, 30/45/60 seconds.
Press "PLAY" to begin the game.
Scoreboard "HOME" shows Player 1, 3; Scoreboard "VISITOR" shows Player 2, 4.
All shots made count 3 points.
Countdown 5 seconds to next player's turn when one player finishes game.
Player with more points scored wins (LED will flash on player with higher score).
Press "PLAY" to restart this game.

3. Battle Back

- Press "PLAY" to enter game 3.
Press "UP/Down" to select playing time, 30/45/60 seconds.
Press "PLAY" to begin the game.
Shot made in "HOME" frame, +2 points scored display on "HOME" board and -2 points for "VISITOR".
Shot made in "VISITOR" frame, +2 points scored display on "VISITOR" board and -2 points for "HOME".
Once a player scores 10 points who wins and game is finished.
Press "PLAY" to restart this game.



Manufacturer's 1-Year Limited Warranty

The manufacturer warrants that all parts and components are defect free in materials and workmanship for 1 year. This warranty is valid only in accordance with the conditions set forth below:

1. The warranty extends only to the original consumer purchaser and is not transferable. In addition, proof of purchase must be demonstrated.
2. This limited warranty is the only written or express warranty given by the manufacturer. Any implied warranty of merchantability or fitness for a particular purpose on this product is limited in duration to the duration of this warranty. Some states do not allow limitations on how long an implied warranty lasts, so the above limitation may not apply to you.
3. This warranty gives you specific legal rights. You may also have other rights which vary by state

Procedure for Replacement or Return within the 1 Year:

To return the product for replacement or refund within the 1 year, the original purchaser must pack the product securely and send it postage paid with a description of the reason for replacement or refund, proof of purchase, and include your order number on the package, to the following address:

Deco Home
80 Carter Drive
Edison, NJ 08817

Other contact info

Phone: 844-413-2646

Customer Service Email: customerservice@decogear.com