

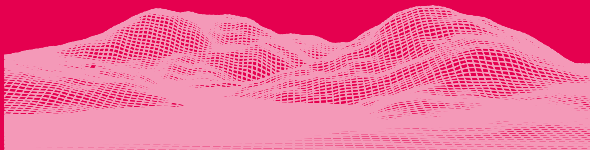

SONIC XL 4K
2 0 2 2



Dear User,

Thank you for joining us. Please read through the entire manual and follow step-by-step instructions to get the best printing experience.

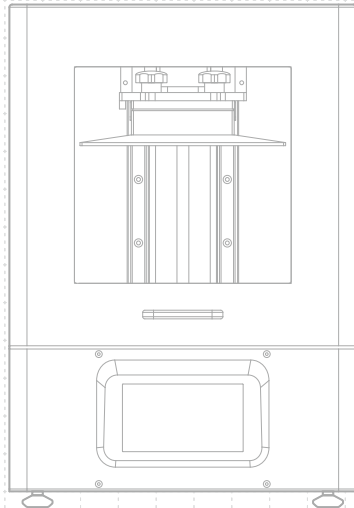

01 Introduction

Printer Parts

PART.1
Building Plate

PART.2
Air Filtration System

PART.3
Resin Vat

PART.4
LCD Screen

PART.5
Touch Panel

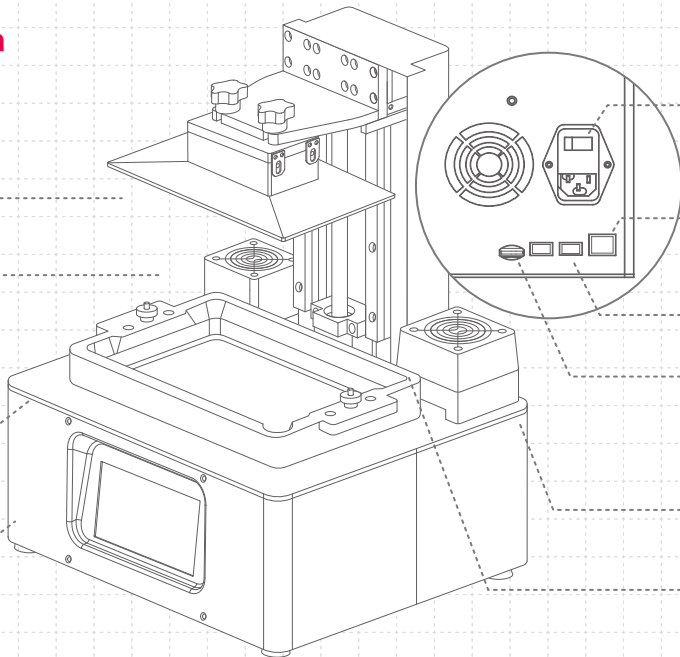

PART.8
Power Switch
Power Socket

PART.9
Network Port

PART.10
USB Port

PART.11
Phrozen OS
SD Card

PART.6
Heater

PART.7
Z-axis

The Toolbox



After Sales Service Card



Gloves



Power Connector



Plastic Funnel



Scrapers



Allen Wrench



USB



WiFi Adapter



Handle

Operation

System	Phrozen OS
Operation	5 inch Touch Panel
Slicer Software	Phrozen Dental Synergy Slicer
Connectivity	USB Ethernet Wi-Fi

Printing Specifications

Technology	Resin 3D Printer - LCD Type
Light Source	405nm ParaLED® 3.0 Module
XY Resolution	52 µm
Layer Thickness	0.01 - 0.30 mm
Max Printing Speed	90 mm / hr
Power Requirement	AC100-240V ; 50-60Hz

Hardware Specifications

Printer Size	33 x 29 x 47 cm
Printing Volume	20 x 12.5 x 20 cm
Printer Weight	17.2 kg

* All specifications were tested in a laboratory and are subject to change without prior notice. For the latest update, please refer to Phrozen's official website.

* The included power cord set packaged with the main unit cannot be used with electrical equipment other than the specified device.

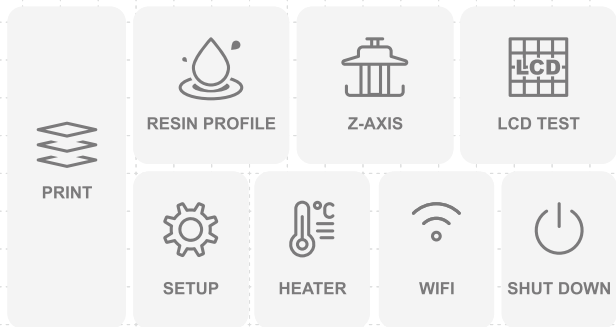

PRINT

Choose your 3D file to begin printing.

RESIN PROFILE

To adjust your settings, click on RESIN PROFILE.

Z-AXIS

Follow instructions on the manual to calibrate the Z-axis.

LCD TEST

Please follow instructions in the user manual to conduct the LCD test.

WIFI

Connects to Phrozen OS Interface.

POWER BUTTON

Click on SHUT DOWN. Then switch off the button at the back to completely turn off the device and avoid system damage.

Notice:

For first-time usage, please follow the user manual and conduct the following steps: Perform Z-axis Calibration, LCD Test, and Test Printing.

SET UP

Click on this button to adjust REBOOT, UPDATE, EXPAND SD, SATATUS and LIGHT settings.

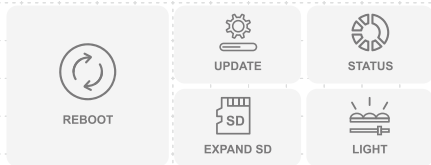

STATUS: Displays the SD Capacity, CPU temperature, and CPU Performance.

LIGHT: Manually adjust the LED light settings from 50% to 100%. The default value is the best performance.

HEATER

Toggle the ON/ OFF button to stabilize the printer.

Tips: After pausing the print for more than an hour, the heater will automatically turn off. Reset this function each time you restart printing.

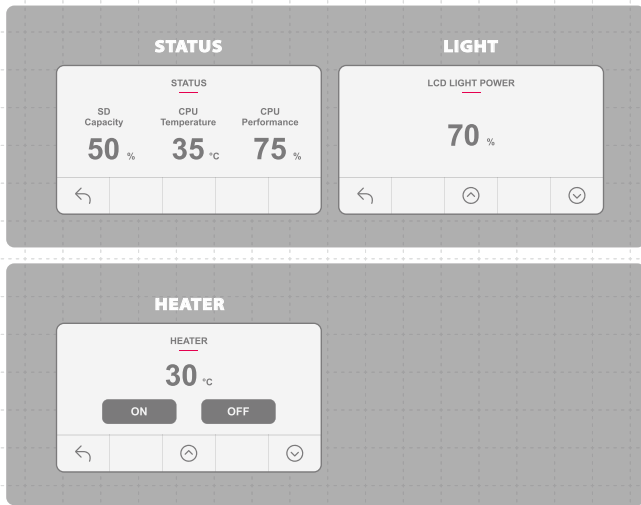

02 Key Notes Before Start

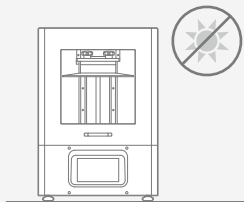

Stable Printing Environment

Store your 3D printer in a dry and ventilated environment. Avoid exposure to direct sunlight. Make sure to place the printer on a flat surface.

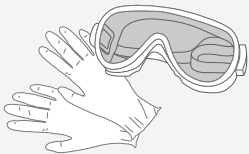

Protective Measures

While printing and using resin, please make sure to wear gloves, masks, protective goggles, and long-sleeved clothing.

Maintenance

Clean the Z-axis

First, dry clean the Z-axis T-screw. Then apply a thin layer of general lubricant on it, so that it whirls smoothly.

Clean the 3D Printer

Use sanitizing alcohol and tissue paper to carefully clean the printer, the resin vat, and the building plate.

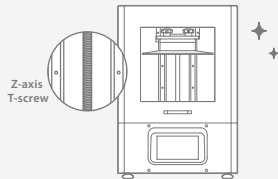

03 Z-axis Calibration

- 1 Click on Z-axis. Then click on Z-axis Calibration.
- 2 Remove the resin vat and place a piece of paper on the LCD screen.
- 3 Install the building plate and loosen all 4 screws on the building plate.
- 4 Click on NEXT.
- 5 The building plate will then be lowered to touch the LCD screen.
- 6 Tighten all 4 screws on the building plate and click DONE.
- 7 Z-axis Calibration is now complete.

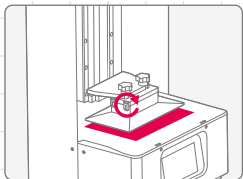
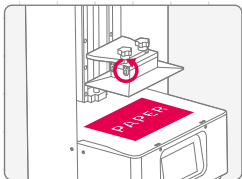

04 LCD Test

- 1 Click on LCD TEST.
- 2 There are three modes to choose from. Please test your LCD screen in the following order.
- 3 When all three modes are clearly displayed on the LCD, LCD TEST is completed.



LCD FILL UP

Confirm the LCD screen fully lights up and there are no black spots.



BLACKENED LCD SCREEN

Confirm the LCD screen covers all the light and there are no light spots.



LCD GRID

Confirm that the LCD screen displays the grid completely.

* *Please refer to the actual printer operation, based on the touchscreen display.

05 Set Up Resin Profiles

Setting on Printer

Follow these steps on the touchscreen:

Resin Profiles > Select the Profile > Modify Settings >

Click "V"

Connect to Phrozen OS Interface

1 Follow these steps on the touchscreen:

WIFI > Select Wireless Network > Enter Password >

Connect > Click OK

2 The IP address will be shown on top of the touchscreen.

3 Open the web browser and type in the IP address of your resin 3D printer.

Notice: Please set the layer height and anti-aliasing in the slicer. They are unable to be adjusted through the printer nor the Phrozen OS Interface.

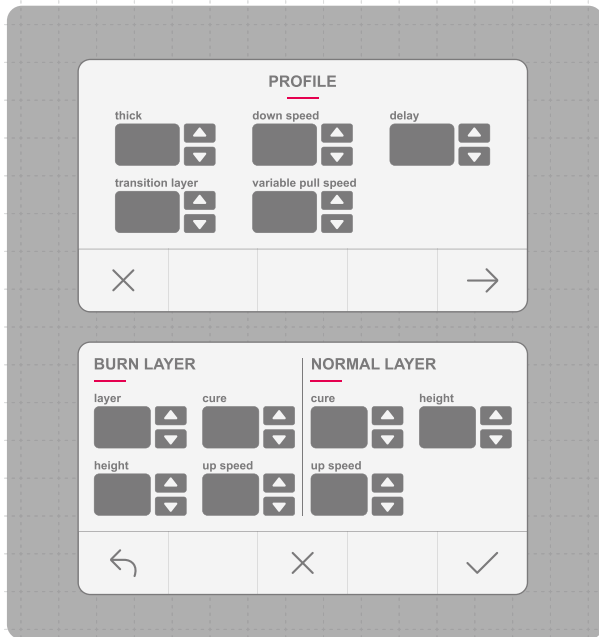

Resin Profile Setting on Phrozen OS Interface

Select the PROFILE page. You can adjust the resin settings, ADD, UPDATE, DELETE or EXPORT the resin profiles, according to your needs.



Online Resin Profile

06 Import 3D Files

via Phrozen OS Interface

- 1 Slice your 3D prints in a slicer software and save it as a **.zip file**.
- 2 Enter Phrozen OS Interface. Select PLATES page. Choose the file from your device and upload it onto the 3D printer.

via USB

- 1 Plug in the USB drive into the 3D printer.
- 2 Using the touchscreen, follow these steps:
PRINT > USB icon > 3D file.zip > Wait for Upload

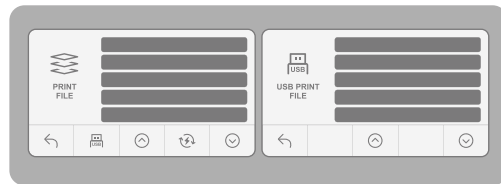

07 Perform the Printing Test

Test Printing

After adjusting the Resin Profile Settings and Importing your Files, we can now Perform the Printing Test.

- 1 Install the building plate and resin vat. Make sure that both are parallel to the printer and its surface is clean.
- 2 Shake the resin bottle for 1 minute. When pouring, make sure the resin does not exceed the mark on the resin vat.
- 3 Click "GO." The building plate will be lowered and the printer will automatically begin printing after a 15 sec delay.

Tips: After 15 sec, the touch panel will automatically display the print page. DO NOT operate the printer before the delayed start in order to avoid a system crash.

- 4 When the printing process begins, the Air Filtration System will turn on automatically.

- 5 Keep the cover closed during printing to prevent excessive UV light.
- 6 Tilt and place the building plate onto a desk and use a metal scraper to carefully remove your print.

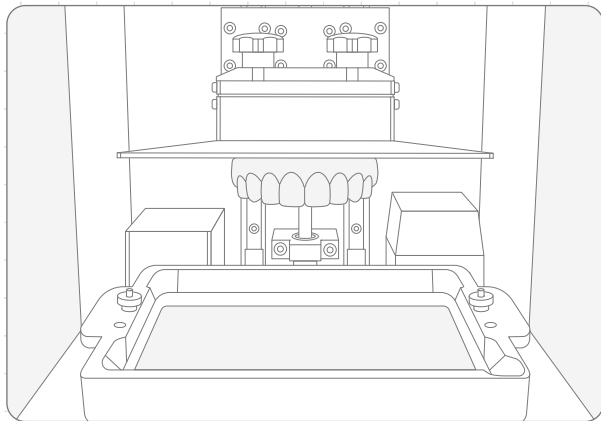

Resume Printing

During the printing process, if the printing is interrupted due to power failure, or printer shutdown, the printing process will be halted. To continue printing the same 3D file, turn the power on and follow the steps below:

Click the following buttons on the touchscreen:

Print > Resume Function > Resume: Yes

Please be aware that there may be a few layer seams present in the printed 3D model as a result of pausing the print.

If using the HEATER, remember to turn on this function when continuing to print the 3D file.



Notice: Frequent abnormal power outages may result in system failure.

After-sales service & warranty

- Phrozen offers a one-year warranty for all parts, excluding consumable components such as the LCD screen and FEP film.
- Sonic XL 4K 2022 screen is covered under a 3-month warranty. Please note that this warranty does not cover any damages caused by human factors.
- If you encounter any difficulties, please scan the QR codes down below to contact us.



Contact us!

Congratulations!

You have just completed your first run.
We hope you've had a great experience!

Please follow us on social media and subscribe
to our Youtube channel to learn more printing
tips, share your creations with the community.



Facebook



Facebook Group



YouTube



Official Website



Chinese User Manual