

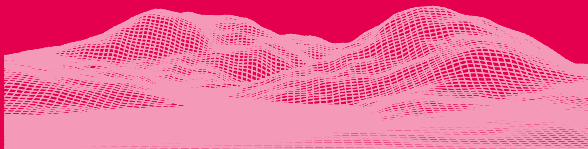

SONIC  
MIGHTY

12K



**Dear User,**

Thank you for joining us. Please read the Sonic Mighty 12K manual thoroughly and follow the instructions step by step to get the best printing experience.

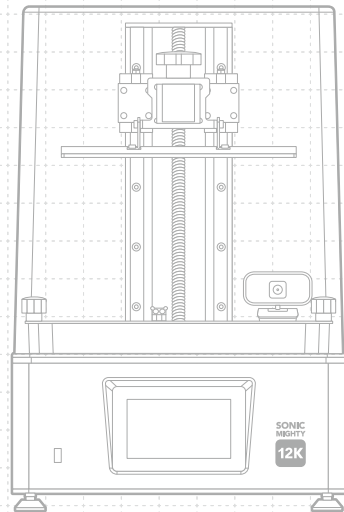



Please scan the QR code for  
Sonic Mighty 12K user manual  
in other languages.

01 Key Notes Before Start	03
02 Introduction	04
03 Prepare Your 3D Printer	06
· Guided Process for Initial Use	06
· Z-Axis Calibration	06
· Moving the Slider on the Z-Axis	07
· Z-Offset Setting	07
04 Prepare Your Print File	08
05 File Import & Network Connection	08
06 First Test Print	10
07 Remote Control App - Phrozen GO	10

# 01 Key Notes Before Start

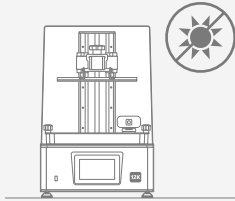

## Stable Printing Environment

Store your 3D printer in a dry and well-ventilated environment. Place it on a flat surface and avoid direct sunlight exposure.

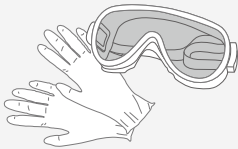

## Protective Measures

When handling resins or prints, please wear Personal Protective Equipment such as gloves, masks, protective goggles, and long-sleeved clothes.

## Maintenance

### Clean the Z-Axis

First, wipe the Lead Screw with Lint Free Wipes. Then, apply a thin layer of general lubricant so that it spins smoothly.

### Clean the 3D Printer

Use 95% alcohol and Lint Free Wipes to carefully clean the printer, resin vat, and the building plate.

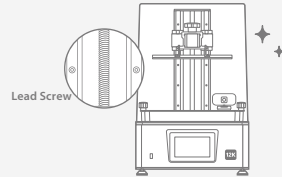

## 02 Introduction

### Printer Parts

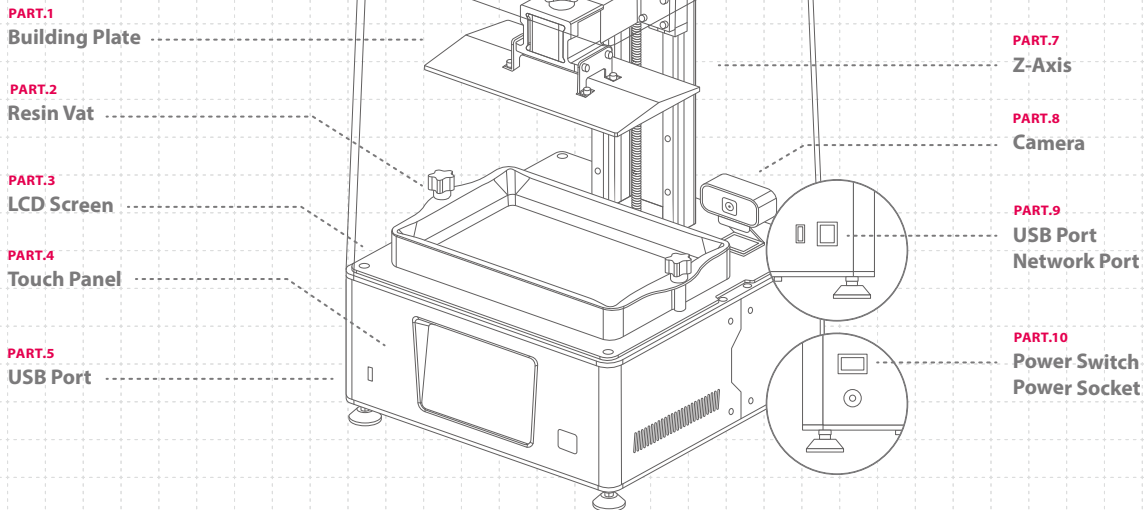

## The Toolbox



Warranty Card



Gloves



Power Cord & Adapter



Plastic Funnel



Metal Scraper



Plastic Scraper



Allen Wrench Set



USB Stick



Wi-Fi Adapter

## Operation

System	Phrozen OS
Operation	5 inch Touch Panel
Slicer Software	CHITUBOX V1.9.6 and above (Or others)
Connectivity	USB   Ethernet   Wi-Fi
Built-in Memory	8.0 GB

## Printing Specifications

Technology	Resin 3D Printer - LCD Type
Light Source	Linear Projection LED Module
XY Resolution	19 x 24 $\mu\text{m}$
Layer Thickness	0.01 - 0.30 mm
Avg. Printing Speed	200 layers / hr
Compatible File Format	.CTB / .PRZ
Power Requirement	DC 24V ; 5A

## Hardware Specifications

Printer Size	33.7 x 33.7 x 51.6 cm
Printing Volume	21.8 x 12.3 x 23.5 cm
Printer Weight	14.3 kg

\* All specifications were tested in a laboratory and are subject to change without prior notice. For the latest update, please refer to Phrozen's official website.

\* The included power cord set packaged with the main unit cannot be used with electrical equipment other than the specified device.

# 03 Prepare Your 3D Printer

## Guided Process for Initial Use

When turning on your 3D printer for the first time, please follow the setup tutorials on the touch panel to complete the initial tests, including the LCD test, Z-Axis Calibration, and first test print.

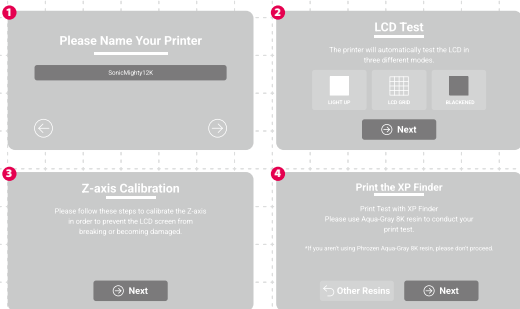

\* If you miss the tutorial setup, please go to the "Settings" page on the left column of the touch panel and click "System Settings" > "Device Test" > "Factory Settings". The machine will restart and display the tutorial setup.

## Z-Axis Calibration

Go to the "Tools" page on the left column of the touch panel and click "Z-Axis Control" > "Z-Axis Calibration".



Follow the on-screen instructions to perform Z-Axis Calibration:

- 1 Remove the resin vat. Place a piece of A4 paper on top of the LCD screen.
- 2 Install the building plate and secure the thumb screw tightly. Then loosen the four calibration screws on both sides of the building plate.
- 3 Wait for the building plate to touch the LCD screen, then tighten the four screws on both sides of the building plate.
- 4 Click "Finish" and wait for the building plate to return to its original position to complete the Z-Axis Calibration.

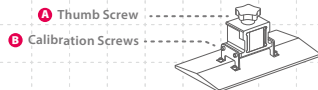

## Moving the Slider on the Z-Axis.

To use this function, please pay attention to the procedure below each time you turn on the printer to let the Z-Axis detect the zero position:

- If you replace or readjust the building plate, Z-Axis, LCD screen, and screen protector, Z-Axis Calibration needs to be performed each time afterward.
- If there is no need to replace or adjust the above structure, please go to the "Tools" page on the left column of the touch panel and click "Z-Axis Control" > "Move to Z-Axis Zero Position".

\* After completing the step, you'll be able to use the slider on the Z-Axis function.

## Z-Offset Setting

Reposition your Z-Axis to print flat objects on the building plate. It is also helpful if the resin is viscous.

- 1 Complete the Z-Axis Calibration first.
- 2 Click "Move to Z-Axis Zero Position"
- 3 Adjust the Z-Axis zero position based on your printing needs.
- 4 Click "Reset Z-Offset" to complete the setting.

**Tips:** Rebooting the firmware and performing Z-Axis Calibration will reset the Z-Offset setting. Please repeat the Z-Offset setting before each printing.

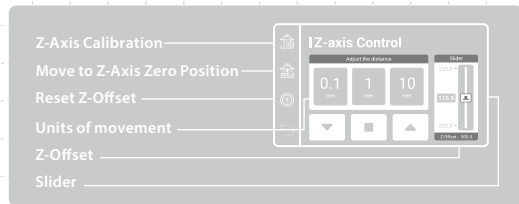

## 04 Prepare Your Print File

The Sonic Mighty 12K supports both .CTB and .PRZ file format. Use slicer software to turn .STL and .OBJ files into .CTB or .PRZ files.

### Convert .STL/.OBJ File to .CTB/.PRZ File

- 1 Import .STL or .OBJ files into the slicer software, and add supports to your models to secure them to the building plate.
- 2 Choose the "Sonic Mighty 12K" printer in the slicer. Set the resin parameters according to your resin and slice.
- 3 After the slicing is completed, save it as a .CTB or .PRZ file and the file are ready to be printed.

### Test Files for Your First Print

- 1 The USB included in the tool box contains both .STL and .CTB files of two test models: "Phrozen\_test" and "Phrozen\_XP\_Finder".
- 2 You can directly print the .CTB files in the USB with Aqua-Gray 8K Resin. If you are printing with other resins, slice the .STL files with the compatible parameter settings required for your resin.



Slicer Software



Supports Tutorial



Resin Parameters



Learn and Download  
Phrozen\_XP\_Finder

## 05 File Import & Network Connection

Sonic Mighty 12K can import files either via USB or network connection. The printer is also equipped with 8.0 GB built-in memory to save transferred files.

### Import Files via USB

- 1 Save the .CTB or .PRZ file to your USB, and plug the USB into the printer.
- 2 On the "Print" menu on your touch panel, click "USB" > select the file you want to print > "Print".

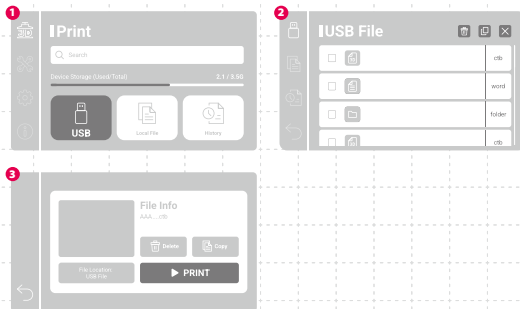



## Import Files via Network Connection

### 1 Select the network connection method

Use the Wi-Fi adapter included in the tool box to connect to Wi-Fi, or plug in a network cable and connect through Ethernet.

### 2 Connecting to the internet

On the " Settings " page on the left column of the touch panel, click " Network " > " Wi-Fi " or " LAN Cable ".



### 3 Locate the printer IP

Return to the " Settings " page and click " Sharing Network " > enable the setting. The " IP Address " is at the bottom-most field.

### 4 Connecting the printer to a computer

Have the computer connect to the same local area network as the printer, and enter the printer IP address into the empty folder location on your computer.

The username and password have to be entered manually for initial use.

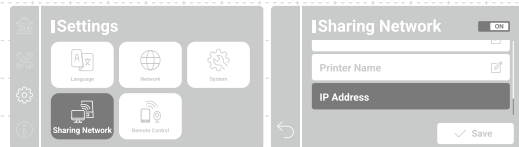

## 06 First Test Print

Use Aqua-Gray 8K Resin and the " Phrozen\_XP\_Finder\_Mighty12K\_AQ8K ".CTB file to perform the test.

- 1 Tighten the screws on your resin vat and building plate. Make sure the building plate and resin vat are clean from any debris.
- 2 Shake the resin bottle for 1 minute. Pour the resin into the vat without exceeding the maximum mark.
- 3 Insert the USB, find the test file named " Phrozen\_XP\_Finder\_Mighty12K\_AQ8K.ctb" and start printing it with Aqua-Gray 8K resin.
- 4 While printing, please keep the lid closed to prevent light exposure that may affect your prints.
- 5 Once printing is complete, carefully remove the building plate and use a metal scraper to carefully remove your print.
- 6 Use a 95% sanitizing alcohol or Washing Station to clean your printed models. After it's fully dry, post-cure your models with a Curing Station.

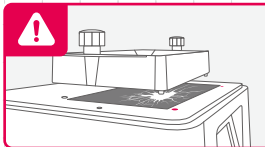

**NOTICE:** When installing the resin vat, please align the screws at the bottom of the resin vat with the platform grooves to avoid damage caused by the screws scratching the LCD panel.

## 07 Remote Control App - Phrozen GO

Phrozen GO is a mobile application designed for Phrozen printer users, so you can always check on your Phrozen 3D printers wherever you are. Please scan the QR Code to access the Phrozen GO tutorial.



Android



iOS

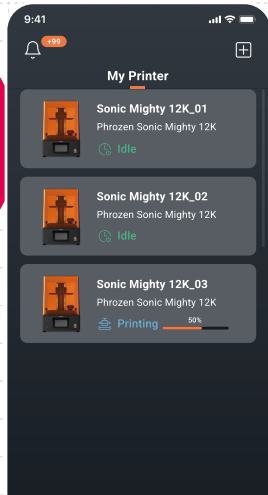

## After-Sales Service & Warranty

- Phrozen offers a one-year warranty for all parts, excluding consumable components such as the LCD screen and PFA (nFEP) vat film.
- Sonic Mighty 12K LCD screen is covered under a 3-month warranty. Please note that this warranty does not cover any damages caused by human factors.
- If you encounter any difficulties, please scan the QR code to contact us.

Contact us!



# Congratulations!

You have just completed your first run.  
We hope you've had a great experience!

Please follow Phrozen's social media accounts  
and subscribe to our YouTube channel to learn  
more about printing tips and share information  
with the community.



Facebook



Facebook Group



YouTube



Instagram