

Scan to watch
assembly video

6IX

Installation Manual

OWNER'S MANUAL

First of all, we would like to thank you for choosing the SIX electric bike.

We warmly welcome you to our Demon Electric family. We wish you enjoy the numerous kilometers and happy moments with your new bike.

TABLE OF CONTENTS

ASSEMBLY INSTRUCTIONS	3
INSTALL KICKSTAND	4
INSTALL HEADLIGHT AND FENDER	4
INSTALL FRONT WHEEL	5
INSTALL HANDLE BARS	6
INSTALL PEDALS	7
INSTALL SEAT.....	8
CONNECT CONNECTORS	8
INSTALL TAIL LIGHT	9
BATTERY CHARGING.....	10
BATTERY CHARGING TIPS	10
OPERATION	10
DISPLAY	11
FEATURES	11
TFT SCREEN INSTRUCTIONS	12
ERROR CODE DEFINE	19
WARNINGS AND SAFETY	20



BELOW ARE THE GUIDELINES FOR THE INITIAL BATTERY CHARGING PROCESS:

- Before using the e-bike for the first time, we strongly recommend that you conduct a preliminary battery check-up and perform a full charge for optimal performance.
- To charge the battery, before riding connect the e-bike to the charger and allow the battery to reach full capacity. According to the manufacturer's instructions, the initial charge typically takes between 48 to 72 hours prior to your first ride.
- During the charging process, keep an eye on the LED indicator or display on your battery charger. This will give you insights into the charging progression. If you encounter any problems, don't hesitate to reach out to the manufacturer for assistance.
- After the battery has been fully charged, it's recommended to take your e-bike out for a test ride. Pay attention to its performance, including the speed, range, and power-assistance levels. Any significant discrepancies might imply that the battery capacity is compromised and needs further attention.
- Even when the e-bike is not being used frequently, it's crucial to regularly charge and discharge the battery. This practice helps to prevent battery degradation during periods of storage.

Email us at pdisales@pdintl.ca

IMPORTANT

Electric Bikes can be dangerous to use. The user or consumer assumes all risk of personal injuries, damage, or failure of the bicycle or system and all other losses or damages to themselves and others and to any property arising as a result of using the bicycle.

As with all mechanical components, the bicycle is subjected to wear and high stresses. Different materials and components may react to wear or stress fatigue in different ways.

If the design life of a component has been exceeded, it may suddenly fail possibly causing injuries to the rider. Any form of crack, scratches or change of coloring in highly stressed areas indicate that the life of the component has been reached and it should be replaced.

Please do not hesitate to contact us. If any problems may occur, please email us at customersupport1@pdintl.ca for any customer service solutions such as replacement parts, technical information, and any other issues.

All new E-Bike purchases come with a 2-year warranty, the warranty card must be filled in and registered in order to qualify for warranty.

For any other commercial or general inquires please contact Demon Powersports at 905 881 9510 or Email us at pdisales@pdintl.ca

PLEASE NOTE: THIS MANUAL IS NOT INTENDED AS A DETAILED USER, SERVICE, REPAIR OR MAINTENANCE MANUAL. PLEASE SEEK ASSISTANCE FROM A QUALIFIED TECHNICIAN FOR SERVICE, REPAIRS OR MAINTENANCE.

DO NOT DISASSEMBLE, MODIFY OR REPLACE ELECTRICAL PARTS.

ASSEMBLY INSTRUCTIONS

Your bike has been pre-assembled and requires only a few simple steps to get it ready for you to ride:

Remove the outside carton after cutting the nylon bands. Remove all the inside cardboard protection and bubble wrap. Carefully remove your bike from the carton and gently rest it in place. **Be careful not to cut any wires when cutting the zip ties.**

Remove brake pad holders when installing, avoid squeezing the brakes when removing the pad holder.

Ensure the following pieces are included in the package. If there are any missing parts, please contact Demon for help replacing missing pieces.

i) Bike



ii) Front Wheel



iii) Front Wheel Axle



iv) Pedals



v) Charger



vi) Assembly Tools

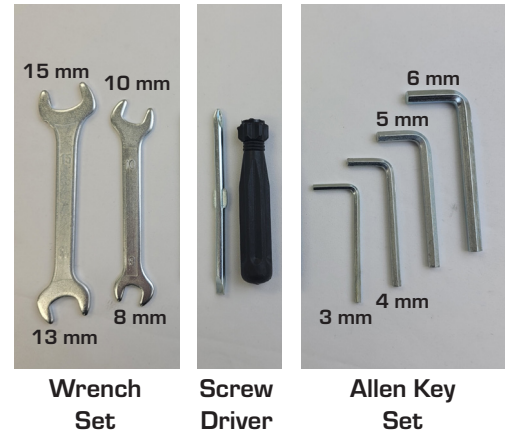

vii) Tail Light



viii) Kickstand



ix) Seat



INSTALL KICKSTAND

Install kickstand with the **5mm Allen key**.
Ensure kickstand is behind the bracket on the left side of the bike during installation.
Turn bolts clock-wise to tighten.



Bracket on left side of the bike.

INSTALL HEADLIGHT

Install the headlight and fender to the front fork with the given long bolt and nut, tighten with the **5mm Allen key** and **10mm wrench**.



Long bolt



Nut

INSTALL FRONT WHEEL

Install the front wheel on the front fork, make sure to align the brake disk with the brake caliper, Avoid squeezing brakes and ensure the brake disc is not rubbing against the wheel. Fasten the wheel hub using the quick release handle.



Smaller side of spring to be facing the wheel.



Ensure brake disk and brake caliper are aligned.



Open quick release handle.



Closed quick release handle.

INSTALL HANDLE BARS

Tighten the 4 pinch screws with the **4mm Allen key**. Loctite is recommend on the screw. Align the brake controls so they are facing slightly downward. Make sure the handlebar is centered.

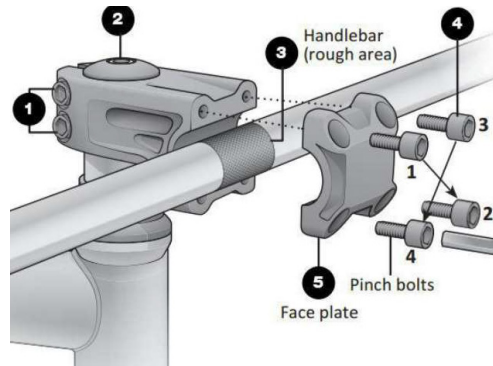

INSTALL PEDALS

Using the **15mm wrench** provided in the toolkit, attach, and tighten the pedals. PLEASE NOTE - The pedals are marked "L" for Left and "R" for Right.

15 mm

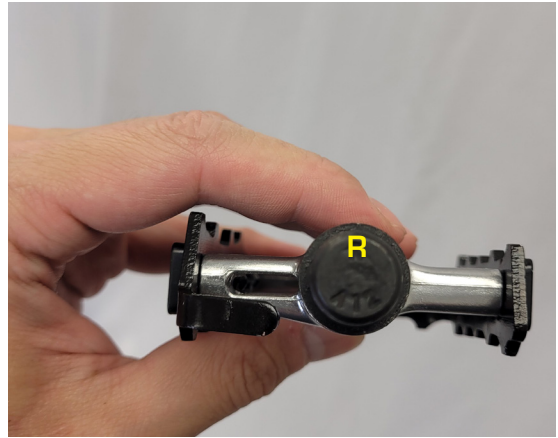
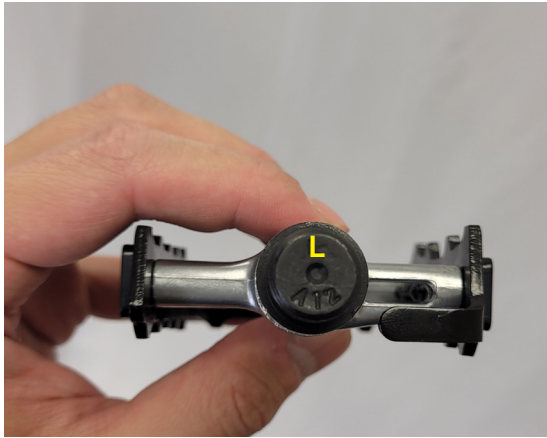

The left pedal is attached by turning it counter clockwise and the right pedal is tightened by turning it clockwise. Make sure the pedals are tightly attached to the crank arms to prevent stripping.

(See picture below)

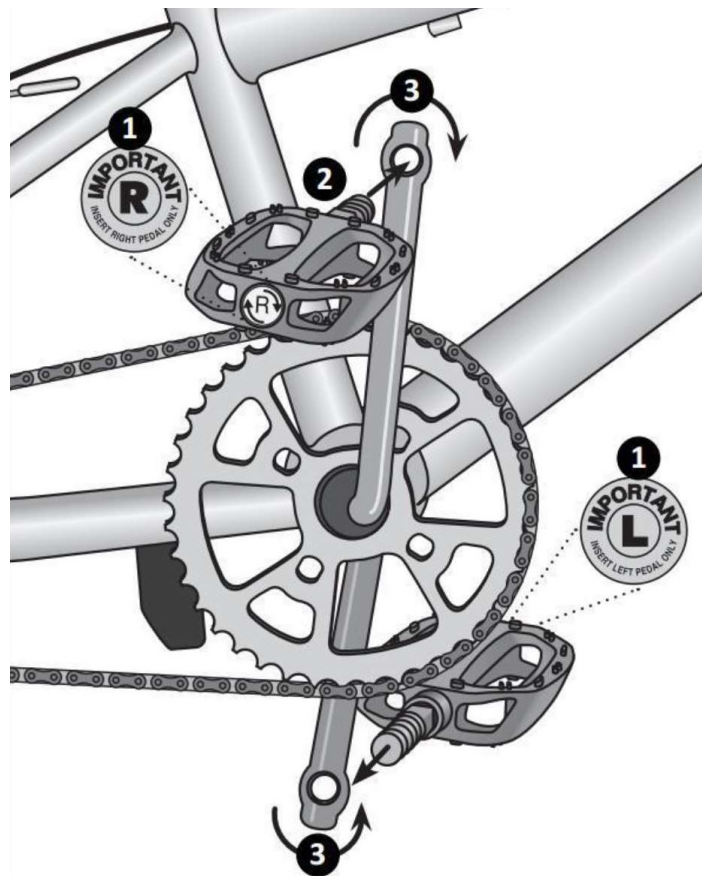

INSTALL SEAT

Make sure the seat is tight enough so that you cannot twist it out of alignment. Pull the seat clamp handle away from the seat post and slide the seat up or down to adjust it. Move the clamp handle inward toward the seat post so it is held tight by the clamp.

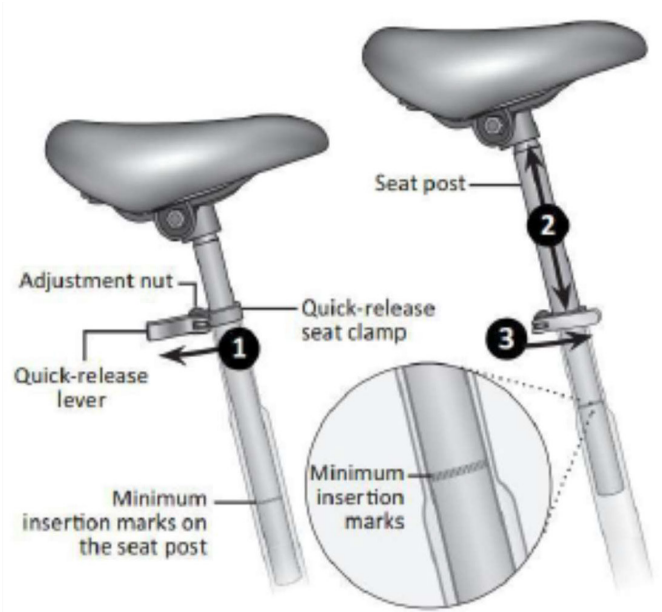

Be sure the minimum insertion marks do not go past the top of the seat clamp and are not visible.

CONNECT CONNECTORS

Connect the connectors near handle bar, make sure arrows are pointing towards each other when connecting.



INSTALL TAIL LIGHT

Place the tail light anywhere on the rear of the bike, fasten the bolt using the provided screw driver.



BATTERY CHARGING

Included with your new 6IX is a lithium ion battery, along with a charger, which plugs into a standard household electric receptacle. A lithium ion battery requires specially designed chargers. You should never charge your battery with a substitute charger that is not designed for this use.

Your 6IX battery arrives with 70% charge. It is recommended that you fully charge the battery before your first use. To charge the battery please follow the steps below:

- Remove the rubber cover on the charging socket
- Place the charger in a flat, secure place, and connect the DC output plug from the charger (round barrel connector) to the charging port on the side of the battery pack.
- The indicator light on the charger will be red / orange when battery is charging and will turn green when fully charged.

The charger will charge a fully depleted battery in 3– 4 hours. If the battery will not be used for an extended period of time, charge it fully and recharge it every 2 months. Store it in a cool, dry place. If you experience unusual sounds or odors coming from the charger or the battery, unplug charger immediately and contact Demon Electric customer service.



BATTERY CHARGING TIPS

- Recharge battery after every use. This will keep the battery in good shape for longer time.
- Do not allow any liquids near or inside the battery charger.
- Do not charge the battery with any other chargers than what was originally supplied with your 6IX
- Fully charge the battery before each use to extend the life of the battery and help to reduce the chance of over discharging the battery pack.
- Do not place the battery near fire or corrosive substances.
- Make sure the charging socket and plug are dry before connecting and charging the battery, and make sure the charger connector is tightly inserted all the way into the socket. Failure to do so may result in HRC (high resistance connection) which could lead to danger of overheating and possible fire hazard.
- Charge the battery in a dry place (indoor) and ensure there is sufficient ventilation.

OPERATION

Your 6IX is equipped with an LCD meter that monitors pedal assist, speed, odometer, trip distance, riding time, and battery energy level.

DISPLAY



FEATURES

- Suitable for low temperature, Max -20 °C.
- High-contrast 3.2inch IPS colorful matrix screen.
- Ergonomic external button design, easy to operate.
- Speed display: AVG SPEED, MAX SPEED, SPEED (Real-time).
- Kilometer / Mile: Can be set according to customers' habits.
- Smart battery indicator: Provide a reliable battery indicator.
- 9-level Assist: 3-level/5-level/9-level optional.
- Mileage indicator: Odometer/Trip distance/ Clock/ Riding time.
- Power indicator: real time power indicator, digital or analog.
- Battery information (needs to be supported by battery communication)
- DST indicator (needs to be supported by battery communication)
- Self-Testing
- Speed limit value indicator
- Error code indicator.
- Light sensor (Optional)
- Software upgraded: Software can be upgraded through UART.
- USB charging port: 5V/500mA

TFT SCREEN INSTRUCTIONS

Your 6IX is equipped with an LCD meter that monitors pedal assist, speed, odometer, trip distance, riding time, and battery energy level. To turn the meter on, make sure the battery is fully inserted into the 6IX battery holder.

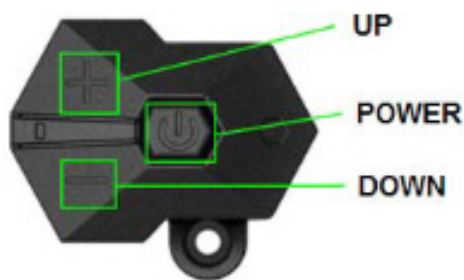
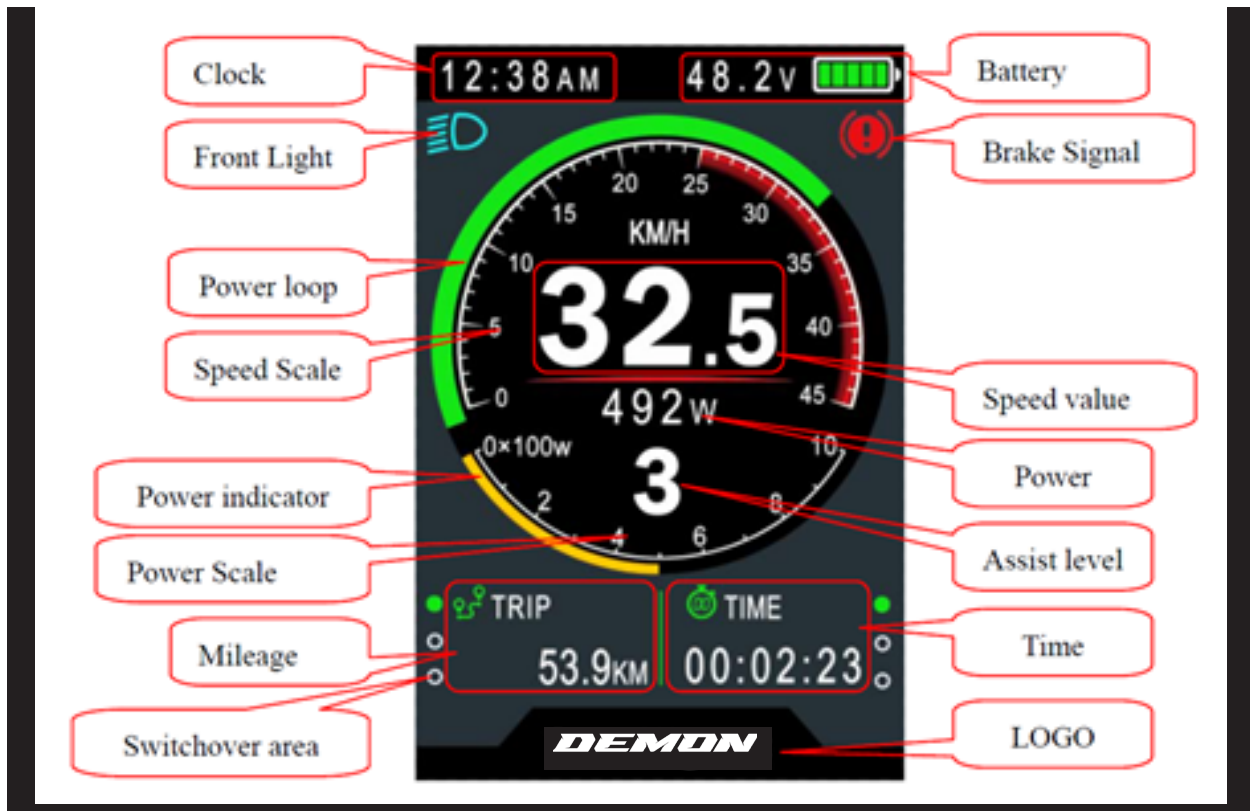

Power On/Off

Press and hold Power button for 1 second can turn on/off the display. The Display can automatically shut down when there is no operate & ride for X minutes (X could be 0~9).

*If the display has been set password power on, you need to input the right password before start.

Assist level operating

Short press UP/DOWN button can change the assist level. Top assist level is 9, 0 for neutral. Level quantities can be adjusted according to the customer requirements.

Speed & Mileage mode switch

Short press POWER button can change the speed and mileage mode, TRIP > ODO > RANGE > TRIP > TIME > MAX SPEED > AVG SPEED



**If there is no operation for 5 seconds, display will return Speed (Real-Time) display automatically.

Headlight On/Off

Press and hold UP button for 1 second can turn on/off the headlight, and the screen will switch to the corresponding mode.

*The motor does not work when the battery voltage is low, display still can keep the headlight on for a while when E-bike is in riding.



Walking Mode (6 KM)

Press and hold DOWN button for 2 second can get into walking mode, out of the mode when releases the button.

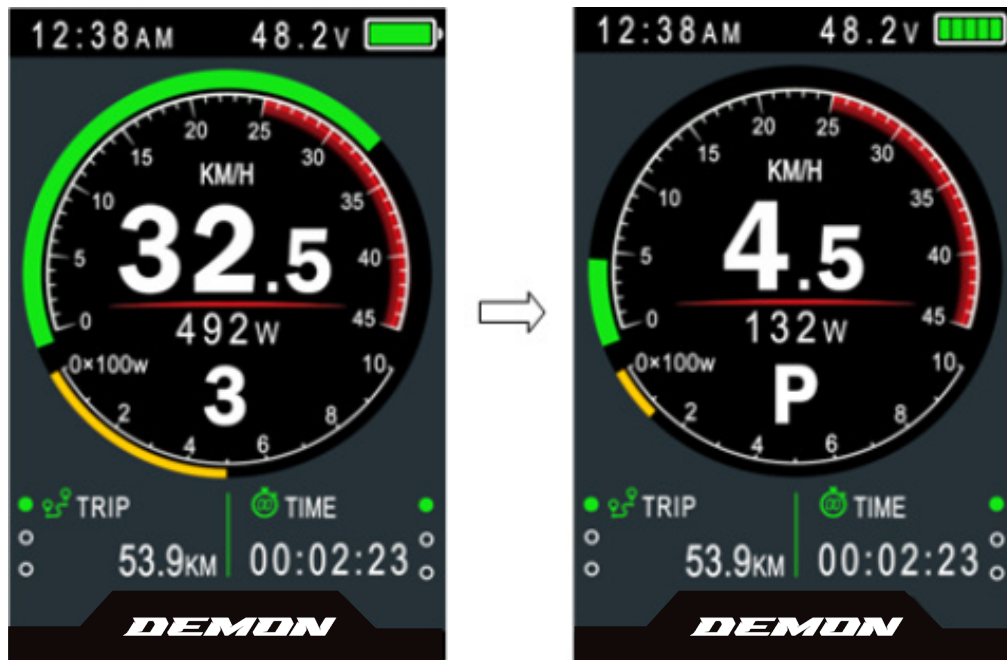

* This feature needs to be supported by controller.

Data cleanup

Press and hold UP & DOWN buttons together for 1 second can reset several temporary data, temporary data include **AVG Speed / MAX Speed / Trip / Time**.

* These temporary data can't be erased by power off.

Parameter setting

Double press POWER button (press interval less than 0.3 second) can get into setting menus, press UP/DOWN buttons to change the parameter setting, press POWER button can switch to next item. Double press POWER button will exit from menu.

* Display will automatically quit menu when there is no operation for 30 seconds.

* For safety reasons, display can't get into MENU when riding.

* Display will quit MENU when start riding.

The e order of parameters is as follow.

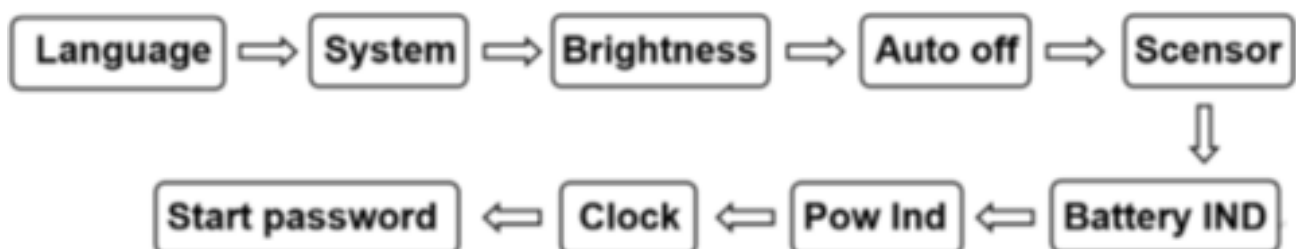

Language: Default EN, Unadjustable

MENU	
Display Setting	
→ Language	EN
System	Metric
Brightness	
Auto off	8 min
Scenes	Analog
Battery Ind	Percent
Pow Ind	Current
Clock	>
Start Password	>
Basic Setting	
...	
EXIT	

System: Press Up / Down button to switch between Metric / Imperial.

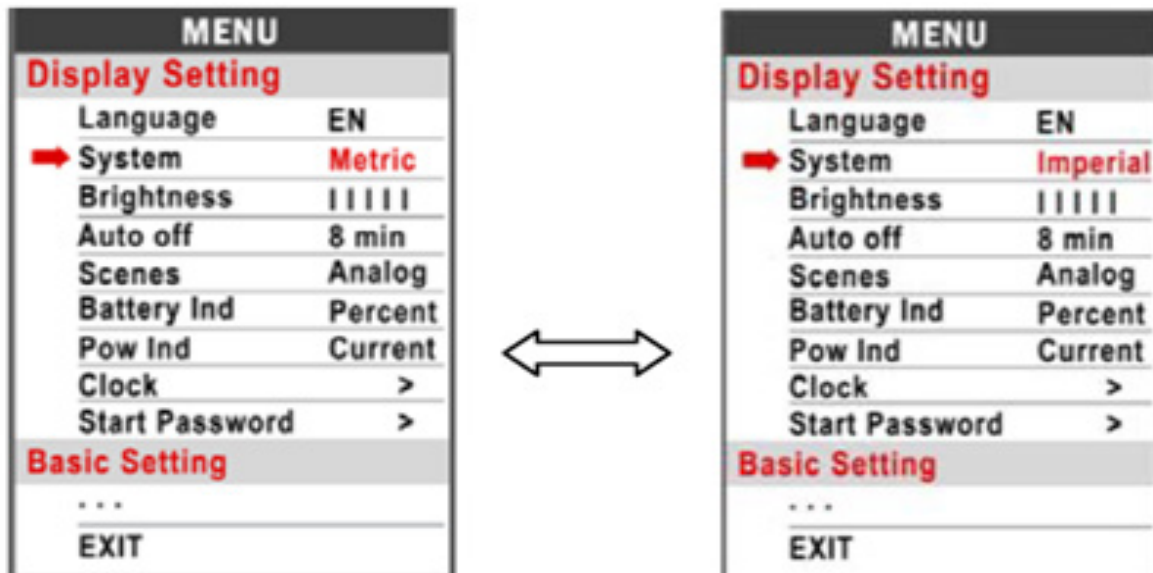

Brightness: Press Up / Down button to change the brightness of the backlight, is darkness is brightness.

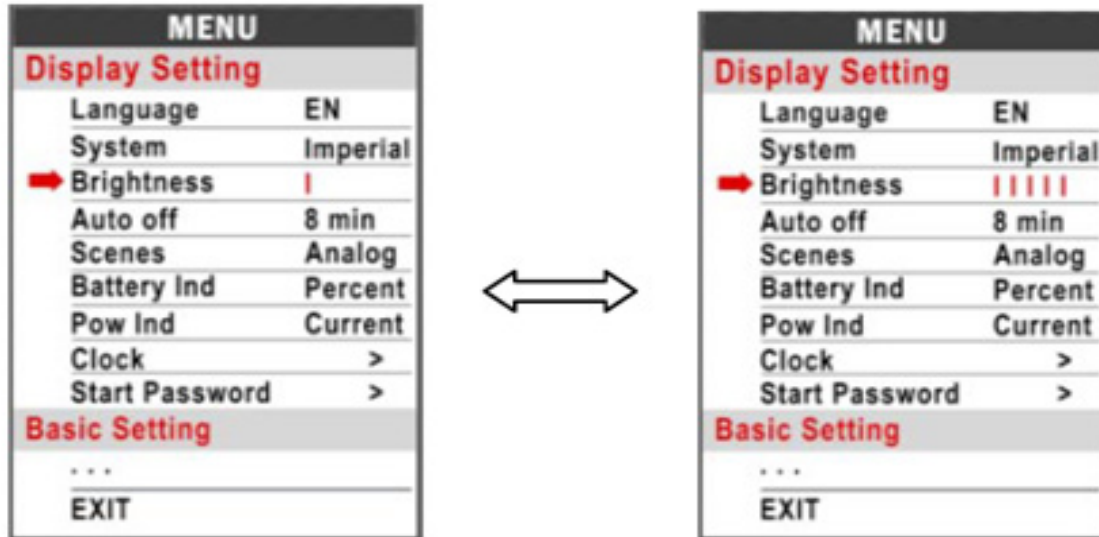

Auto off: Press UP/DOWN button to change the auto power off time, from 1 to 9, the number represent time (minutes) to shut down, default value is 5 minutes.

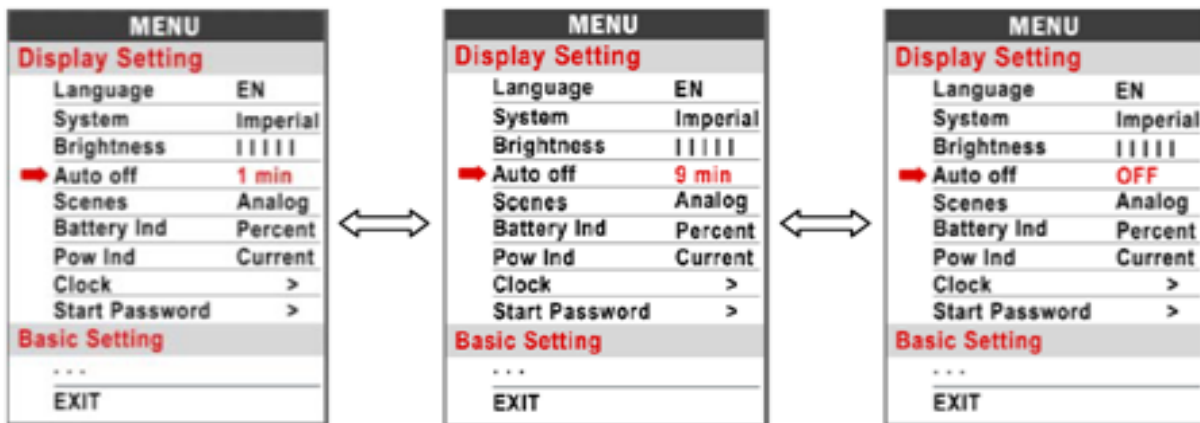

Scenes: Press UP/DOWN button to change the scenes, Digital / Analog(default).

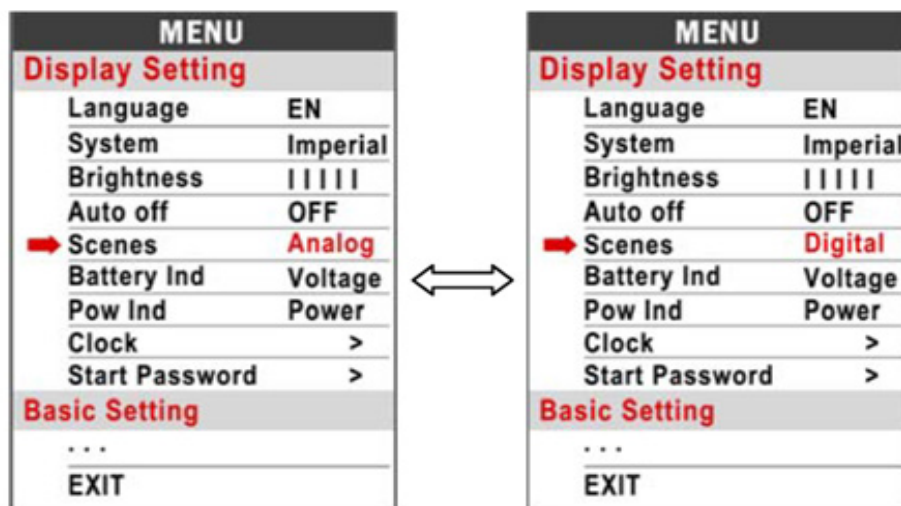

Battery Ind: Press UP/DOWN button to change the battery indicator, Voltage / Percentage / OFF.

*Accurate percentage needs communication with battery.



Pow Ind: Press UP/DOWN button to change the Power indicator, Power / Current.

* This data represents power output of the battery (not motor).

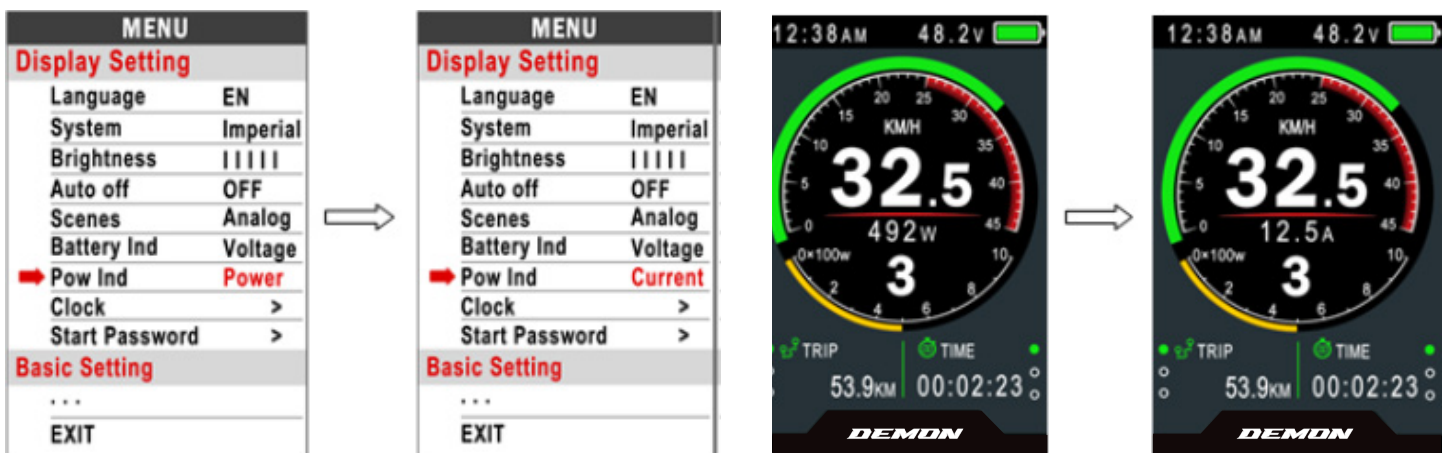

Clock: Clock setting, press POWER button get into the clock setting menu, press UP/DOWN button to set Year/Month/Day/Hour/Min/Sec.

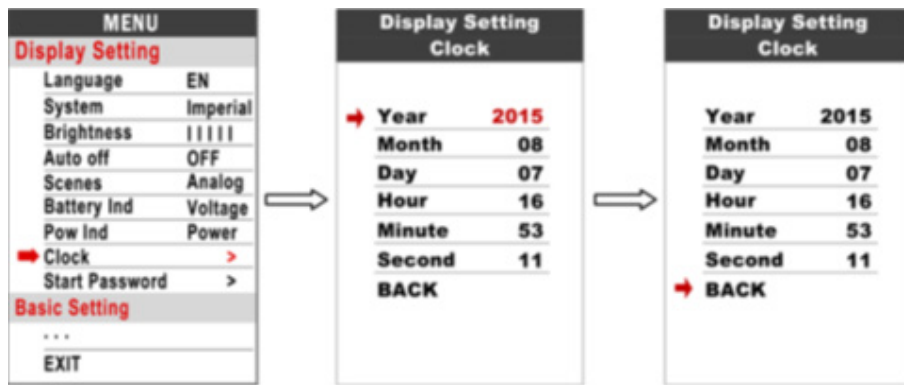

Start Password: Press POWER button get into the password setting menu. If you had set Start input ON, you must input right password before power on, password is accorded to your setting.

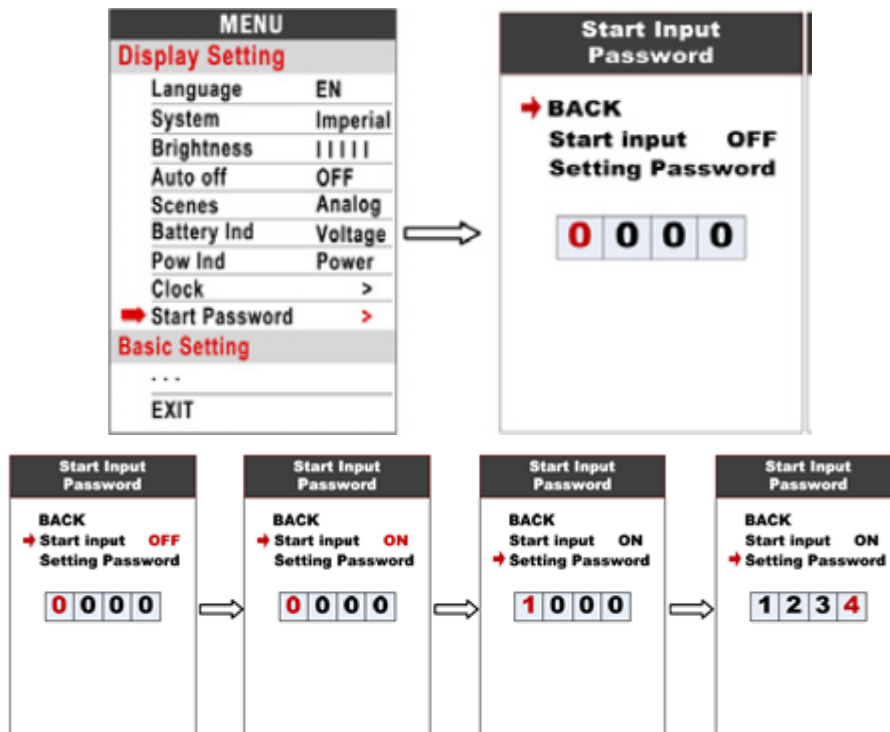

You need to input the right password before start with 30 seconds, display will power off automatically if the password was wrong.

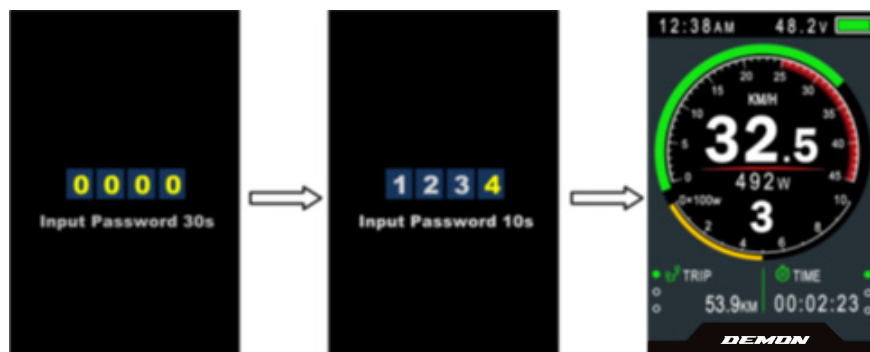

Factory setting: Press POWER button enter Restore Factory settings item, set YES will restore all parameter to factory settings.



Information: Show information of the E-bike.



ERROR CODE DEFINE

850C can show warning message,  icon shows on the screen, and show error code at the bottom of the screen, error code from 01~25, definition see the table below.



Error Code	Error description	Handle
01	Communication Error	Check the cable connection
21	Current protection	Check controller.
22	Throttle error	Check turn to connect.
23	three-phase power error	Check three-phase power line connection
24	Hall error	Check the hall connection
25	Brake error	Check the brake connection.
26-99	Reserved	Please contact the manufacturer for error definitions

WARNINGS AND SAFETY

You should check the operation of your brake inhibitor switches before every ride. While riding slowly in a controlled environment (like a driveway), engage the motor, then squeeze each brake in turn. The motor should lose power immediately and remain off as long as a brake lever is depressed.

Always use the lowest assist setting until you are comfortable with the bike and feel confident controlling the electric assist.

Keep your hands on the brake levers and remember that they will always slow or stop the bike if pulled.

Use only the battery provided with your bicycle. Even if it is physically possible to connect another type of battery, it is dangerous and potentially damaging to do so.

Never short circuit on the discharge terminals of the battery. A short circuit will damage the battery and could cause a fire resulting in severe injury or death, and property damage. When handling the battery outside the bicycle, be aware of conductive materials that may short the battery terminals, such as coins, nails, etc.

Electric bikes are faster and heavier than normal bikes. When riding in wet weather, you should use extra caution.

Local laws may prohibit the use of high-speed electric bicycles on bike paths or trails. Be sure you are familiar with the laws in your area. Even if legal, it is usually not safe to ride at high speed on paths or trails around other users.

Like any mechanical device, a bicycle and its components are subject to wear and stress. Different materials and mechanisms wear or fatigue from stress at different rates and have different life cycles. If a component's life cycle is exceeded, the component can suddenly and catastrophically fail, causing serious injury or death to the rider.

Scratches, cracks, fraying, and discoloration are signs of stress-caused fatigue and indicate that a part is at the end of its useful life and needs to be replaced.

Electric Bikes can be dangerous to use. The user or consumer assumes all risk of personal injuries, damage, or failure of the bicycle or system and all other losses or damages to themselves and others and to any property arising because of using this bicycle.

Website: www.demonelectric.ca
Address: 25 A East Pearce St Unit 2,
Richmond Hill, ON L4B 2M9
Toll Free: 1-855-373-4685
Telephone: 905 881 9510