



TRONIO

Installation Manual

OWNER'S MANUAL

First of all, we would like to thank you for choosing the TRONIO electric bike.

We warmly welcome you to our Demon Electric family. We wish you enjoy the numerous kilometers and happy moments with your new bike.

After the initial shipment we have made many improvements and modifications for the TRONIO including:

- Suspended seat post - Takes the shock out of the big bumps, without the cost or complexity of suspension.
- Adjustable handlebar stem- Provides up to 1 1/2" of rise and reach adjustment, for fully customizable riding position.
- Upgraded Shimano derailleur- Rigid cast aluminum construction gives smoother, more precise shifting.
- New gearing, with taller top gear for relaxed touring, plus a lower low gear for tight, technical riding.
- Demon Electric E-Bikes can be upgraded with additional accessories, such as water bottle holders, phone mounts, etc.

TABLE OF CONTENTS

ASSEMBLY INSTRUCTIONS	3
INSTALL KICKSTAND	4
INSTALL HEAD LIGHT AND FENDER	5
INSTALL FRONT WHEEL	6
INSTALL HANDLE BARS	7
INSTALL PEDALS	8
INSTALL SEAT	9
CONNECT CONNECTORS	9
REMOVING BATTERY	10
BATTERY CHARGING	11
BATTERY CHARGING TIPS	11
OPERATION	11
DISPLAY	12
ERROR CODE DEFINE	22
WARNINGS AND SAFETY	23



BELOW ARE THE GUIDELINES FOR THE INITIAL BATTERY CHARGING PROCESS:

- Before using the e-bike for the first time, we strongly recommend that you conduct a preliminary battery check-up and perform a full charge for optimal performance.
- To charge the battery, before riding connect the e-bike to the charger and allow the battery to reach full capacity. According to the manufacturer's instructions, the initial charge typically takes between 48 to 72 hours prior to your first ride.
- During the charging process, keep an eye on the LED indicator or display on your battery charger. This will give you insights into the charging progression. If you encounter any problems, don't hesitate to reach out to the manufacturer for assistance.
- After the battery has been fully charged, it's recommended to take your e-bike out for a test ride. Pay attention to its performance, including the speed, range, and power-assistance levels. Any significant discrepancies might imply that the battery capacity is compromised and needs further attention.
- Even when the e-bike is not being used frequently, it's crucial to regularly charge and discharge the battery. This practice helps to prevent battery degradation during periods of storage.

Email us at pdisales@pdintl.ca

IMPORTANT

Electric Bikes can be dangerous to use. The user or consumer assumes all risk of personal injuries, damage, or failure of the bicycle or system and all other losses or damages to themselves and others and to any property arising as a result of using the bicycle.

As with all mechanical components, the bicycle is subjected to wear and high stresses. Different materials and components may react to wear or stress fatigue in different ways.

If the design life of a component has been exceeded, it may suddenly fail possibly causing injuries to the rider. Any form of crack, scratches or change of coloring in highly stressed areas indicate that the life of the component has been reached and it should be replaced.

Please do not hesitate to contact us. If any problems may occur, please email us at customersupport1@pdintl.ca for any customer service solutions such as replacement parts, technical information, and any other issues.

All new E-Bike purchases come with a 2-year warranty, the warranty card must be filled in and registered in order to qualify for warranty.

For any other commercial or general inquires please contact Demon Powersports at 905 881 9510 or Email us at pdisales@pdintl.ca

PLEASE NOTE: THIS MANUAL IS NOT INTENDED AS A DETAILED USER, SERVICE, REPAIR OR MAINTENANCE MANUAL. PLEASE SEEK ASSISTANCE FROM A QUALIFIED TECHNICIAN FOR SERVICE, REPAIRS OR MAINTENANCE.

DO NOT DISASSEMBLE, MODIFY OR REPLACE ELECTRICAL PARTS.

ASSEMBLY INSTRUCTIONS

Your bike has been pre-assembled and requires only a few simple steps to get it ready for you to ride:

Remove the outside carton after cutting the nylon bands. Remove all the inside cardboard protection and bubble wrap. Carefully remove your bike from the carton and gently rest it in place. **Be careful not to cut any wires when cutting the zip ties.**

Remove brake pad holders when installing, avoid squeezing the brakes when removing the pad holder.

Ensure the following pieces are included in the package. If there are any missing parts, please contact Demon for help replacing missing pieces.

i) Bike



ii) Front Wheel & Axle



iii) Front Fender



iv) Pedals

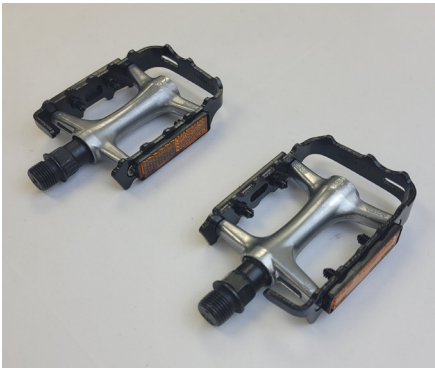

v) Charger



vi) Assembly Tools

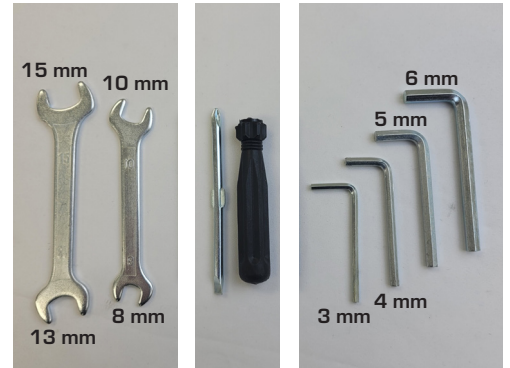

Wrench Set

Screw Driver

Allen Key Set

vii) Key for Battery



viii) Tail Light



ix) Kickstand



x) Seat



INSTALL KICKSTAND

Install kickstand with the **5mm Allen key**.

Ensure kickstand is behind the bracket on the left side of the bike during installation.



Bracket on left side of the bike.

Turn bolts clock-wise to tighten.



INSTALL HEADLIGHT AND FENDER

Install the headlight and fender to the front fork with the given long bolt and nut, tighten with the **5mm Allen key** and **10mm wrench**.

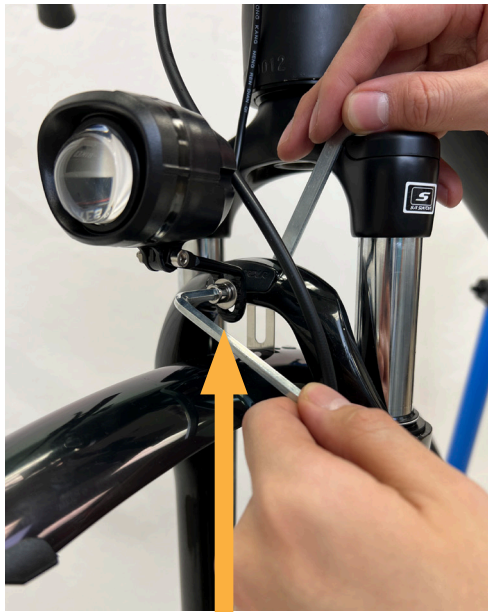

Long bolt

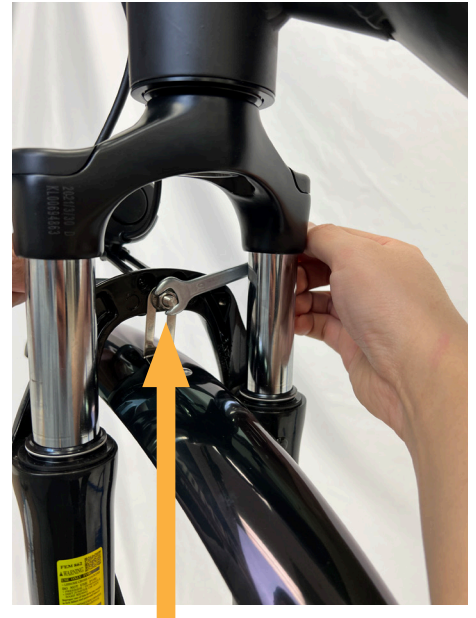

Nut

Install fender support to the fork using the **4 mm allen key**.



fender support

INSTALL FRONT WHEEL

Install the front wheel on the front fork, make sure to align the brake disk with the brake caliper, Avoid squeezing brakes and ensure the brake disc is not rubbing against the wheel. Fasten the wheel hub using the quick release handle.



Ensure brake disk and brake caliper are aligned.

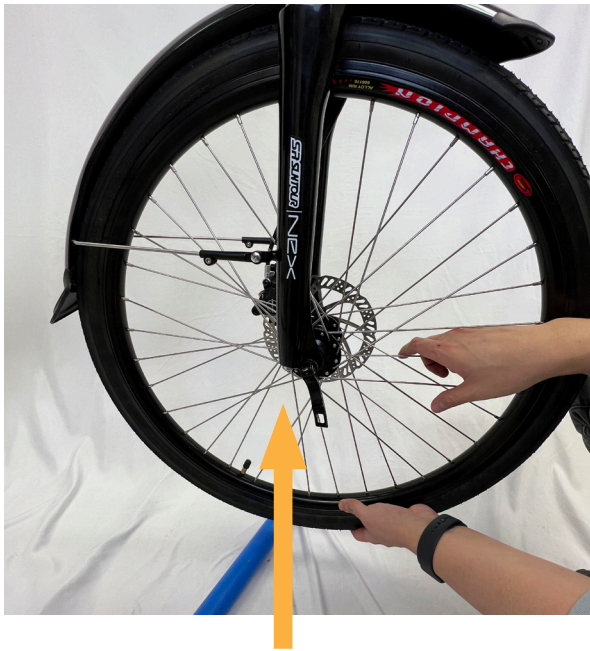

Open quick release handle.



Closed quick release handle.

INSTALL HANDLE BAR

Tighten the 4 pinch screws with **4mm Allen key**. Loctite is recommend on the screw. Align the brake controls so they are facing slightly downward. Make sure the handlebar is centered.



Fine tune the position to align with your arm when seated, stem rise angle can be adjusted by loosen the big side screw with **6mm Allen key**.



INSTALL PEDALS

Using the **15mm wrench** provided in the toolkit, attach, and tighten the pedals. PLEASE NOTE - The pedals are marked "L" for Left and "R" for Right.

15 mm

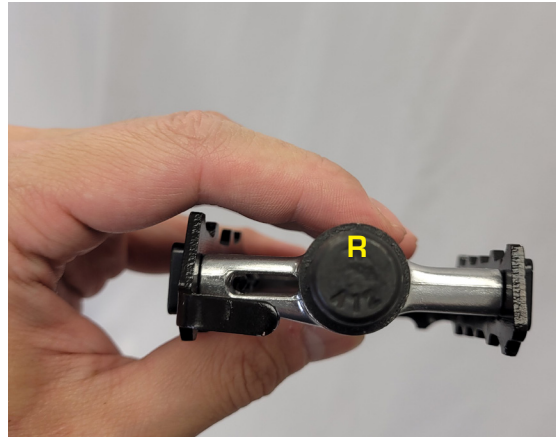
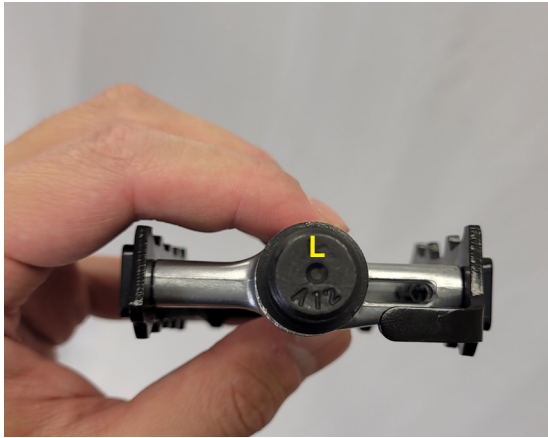

The left pedal is attached by turning it counter clockwise and the right pedal is tightened by turning it clockwise. Make sure the pedals are tightly attached to the crank arms to prevent stripping.

(See picture below)

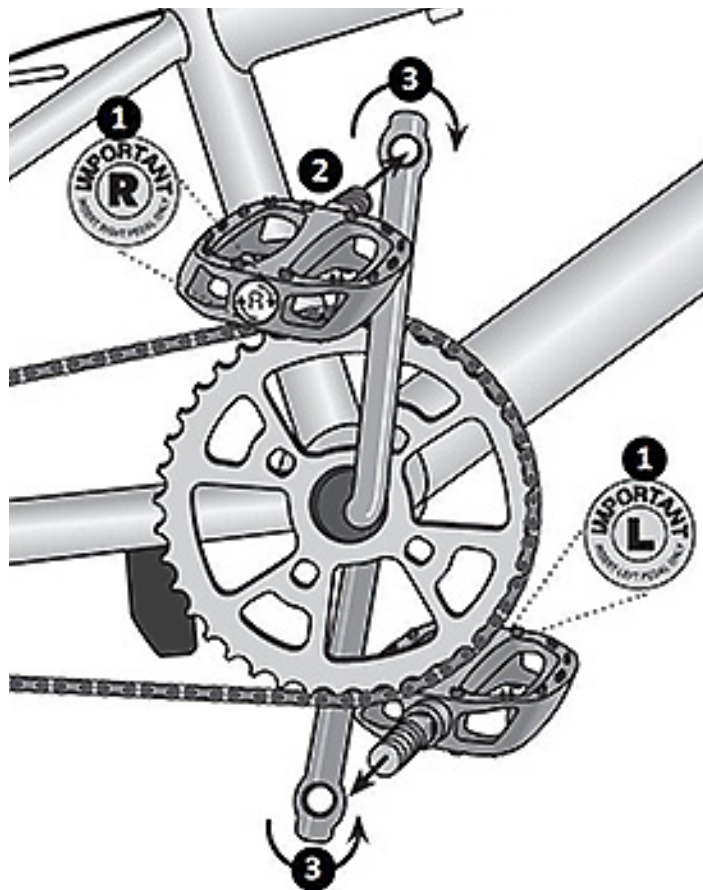

INSTALL SEAT

Make sure the seat is tight enough so that you cannot twist it out of alignment. Pull the seat clamp handle away from the seat post and slide the seat up or down to adjust it. Move the clamp handle inward toward the seat post so it is held tight by the clamp.



Be sure the minimum insertion marks do not go past the top of the seat clamp and are not visible.

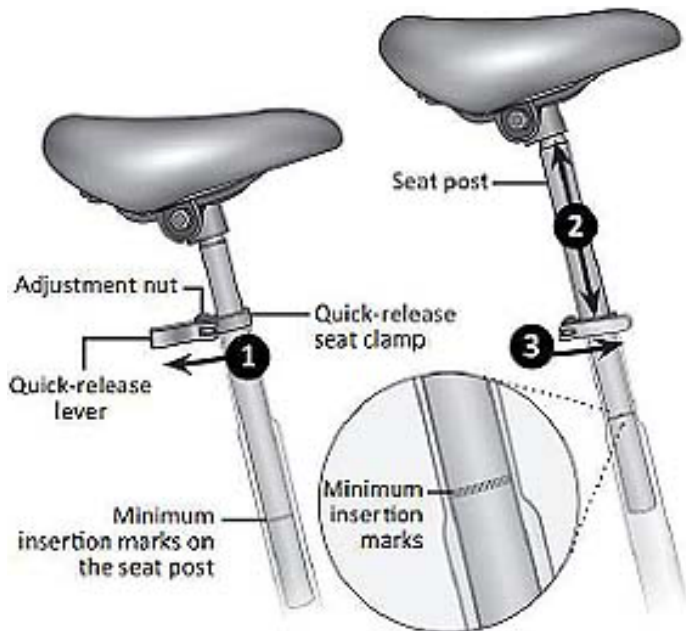

CONNECT CONNECTORS

Connect the connectors near handle bar, make sure arrows are pointing towards each other when connecting. Locate the battery key near handle bar and cut the key from zip tie.



REMOVING BATTERY

To remove the battery, insert and turn the provided key (located on the handlebar), and turn lever located on the battery.



Turn lever and key



Pull up to remove battery.



The serial number is located at the bottom of the frame.

BATTERY CHARGING

Included with your new TRONIO is a lithium ion battery, along with a charger, which plugs into a standard household electric receptacle. A lithium ion battery requires specially designed chargers. You should never charge your battery with a substitute charger that is not designed for this use.

Your TRONIO battery arrives with 70% charge. It is recommended that you fully charge the battery before your first use. The Thunderbolt battery may be charged while on the bike or removed and charged at a location away from the Thunderbolt. To charge the battery please follow the steps below:

- Remove the rubber cover on the charging socket
- Place the charger in a flat, secure place, and connect the DC output plug from the charger (round barrel connector) to the charging port on the side of the battery pack.
- The indicator light on the charger will be red / orange when battery is charging and will turn green when fully charged.

The charger will charge a fully depleted battery in 3– 4 hours. If the battery will not be used for an extended period of time, charge it fully and recharge it every 2 months. Store it in a cool, dry place. If you experience unusual sounds or odors coming from the charger or the battery, unplug charger immediately and contact Demon Powersports customer service.



BATTERY CHARGING TIPS





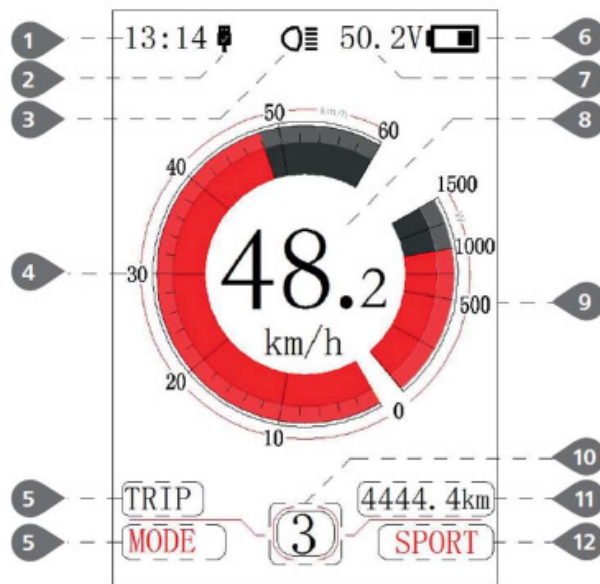

- Recharge battery after every use. This will keep the battery in good shape for longer time.
- Do not allow any liquids near or inside the battery charger.
- Do not charge the battery with any other chargers than what was originally supplied with your TRONIO
- Fully charge the battery before each use to extend the life of the battery and help to reduce the chance of over discharging the battery pack.
- Do not place the battery near fire or corrosive substances.
- Make sure the charging socket and plug are dry before connecting and charging the battery, and make sure the charger connector is tightly inserted all the way into the socket. Failure to do so may result in HRC (high resistance connection) which could lead to danger of overheating and possible fire hazard.
- Charge the battery in a dry place (indoor) and ensure there is sufficient ventilation.

OPERATION

Your TRONIO is equipped with an LCD meter that monitors pedal assist, speed, odometer, trip distance, riding time, and battery energy level. To turn the meter on, make sure the battery is fully inserted into the TRONIO battery holder.

DISPLAY



- 1 **Time display:** The time is represented in the 24-hour system and show the current time, time can be set in the “Set clock”.
- 2 **USB charge display:** When external connect into the display, it displays the symbol.
- 3 **Headlight indication:** Only shows when headlight is on.
- 4 **Speed scale display:** The scale value is in accordance with the digital value.
- 5 **Mode select:** Single-trip distance (TRIP) > total distance > ODO > maximum speed (MAX) > average speed (AVG) > remaining distance (RANGE) > energy consumption (CALORIES) > time (TIME).
- 6 **Battery level display:** Display current battery level value.
- 7 **Voltage display/percentage display:** Display actual battery level value, display mode can be set in the “Soc View”.
- 8 **Speed digital display:** Display current speed value, speed unit can be set in “Unit”.
- 9 **Power scale display/current scale display:** Display current output value, output unit can be set in “Power View”.
- 10 **Power assistant level display/walk assistance:** Display the seven levels as “0”/“1”/“2”/“3”/“4”/“5”/ , briefly press (0.5S)  or  to switch the level. Touch and hold (2S)  to start the mode “walk assistance”, display  symbol.
- 11 **Mode data display:** Display current data corresponding to the mode.
- 12 **Riding mode display:** Display current riding mode, “SPORT” or “ECO”, can touch and hold (2S)  to switch the mode.



Normal Operation

On/Off Switch: Turn on the power, press and hold (>2S) to power on the display. Press and hold (>2S) again to power off the display. If the bike is not used after 5 minutes (time can be set in "Auto Off") the display will be automatically turned off. If the password function of the display is activated, need to input the correct password to enter into the normal interface.

Power Assistance Level Select

In the manual gearshift mode, briefly press (<0.5S) or to switch the level to change assistance power; the lowest level is level 0, the highest level is level 5. When the display is on, the default mode is level 1, "0" means no power assistance.

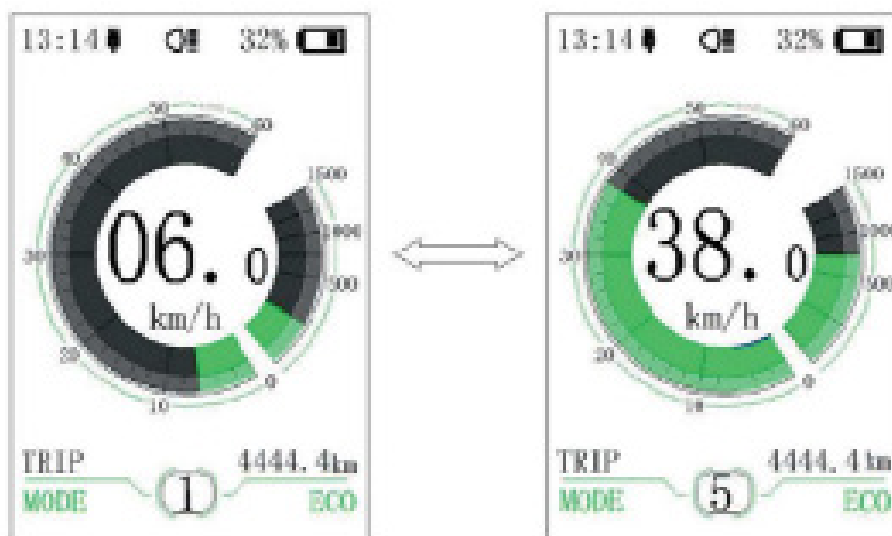

Switch between Distance Mode and Speed Mode

Briefly press (0.5s) **[i]** to switch the display between the distance and speed, cycle show signal-trip distance (TRIP) > total distance (ODO) > maximum speed (MAX) > average speed (AVG) > remaining distance (RANGE) > energy consumption (CALORIES) > time (TIME). Energy consumption unit CALORIES means kCal.

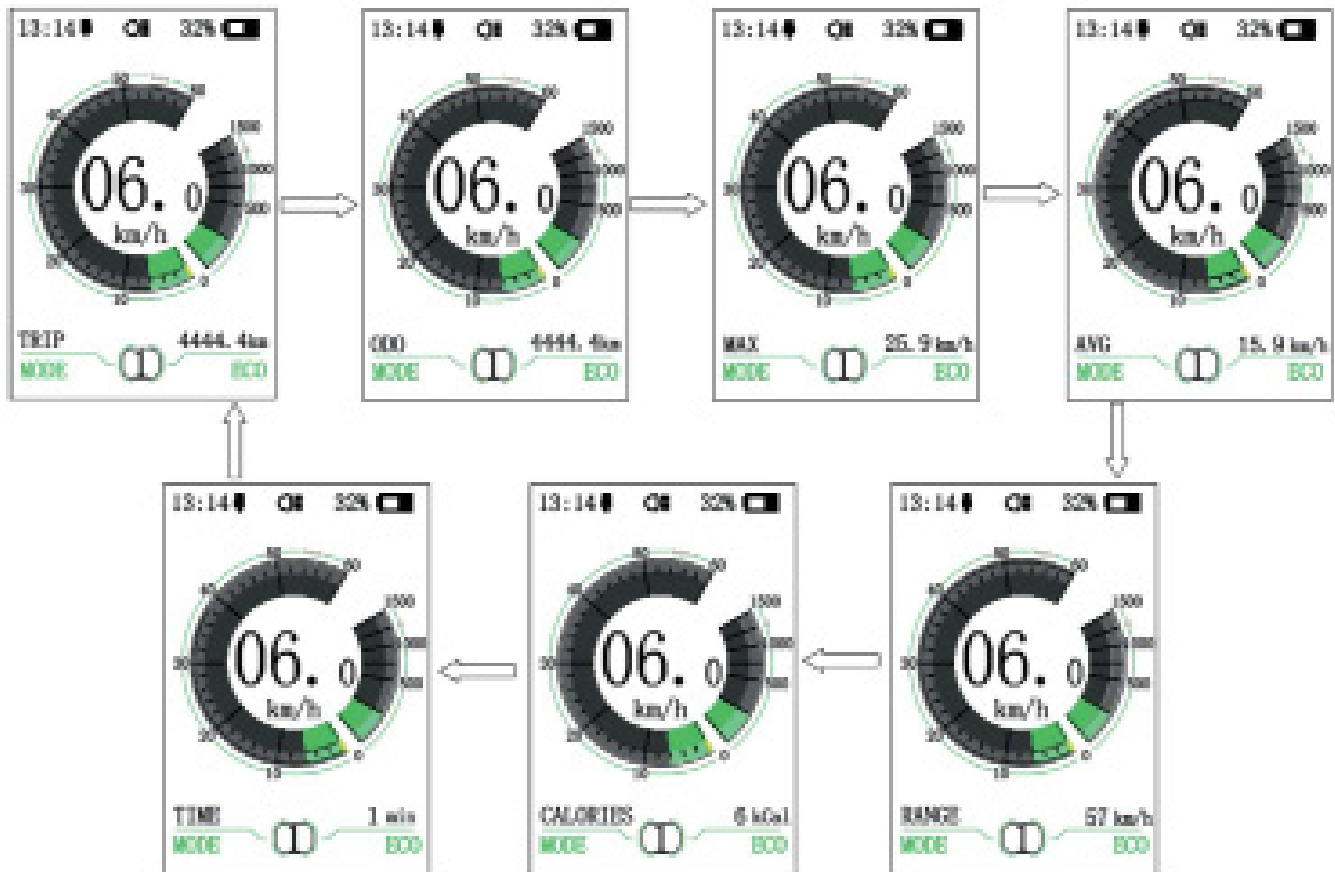

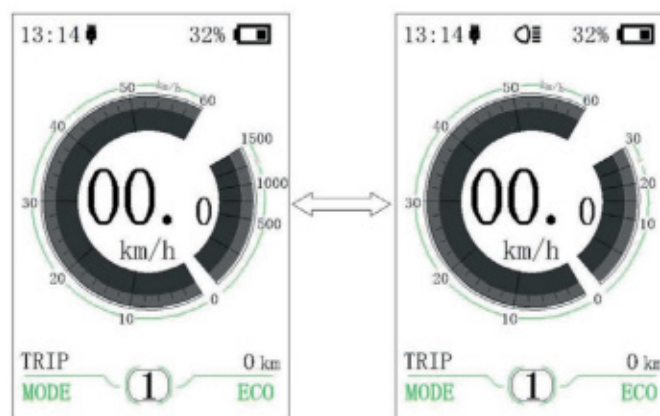

Headlight/Display Backlight Switch

Press and hold (>2S) **[E]** to turn on the display backlight as well as headlight. Press and hold (>2S) **[E]** again to turn off the display backlight and the headlight. There are 5 levels of backlight brightness that can be selected by the user (can be set in the "Brightness"). (If the display is turned on in a dark environment, the display backlight/ headlight will be turned on automatically. If the display backlight/headlight are turned off manually, they also need to be turned on manually afterwards)



Walk assistance mode

Press and hold (>2S)  to enter walk assistance mode, the symbol is displayed, when release key , will exit the walk assistance mode.

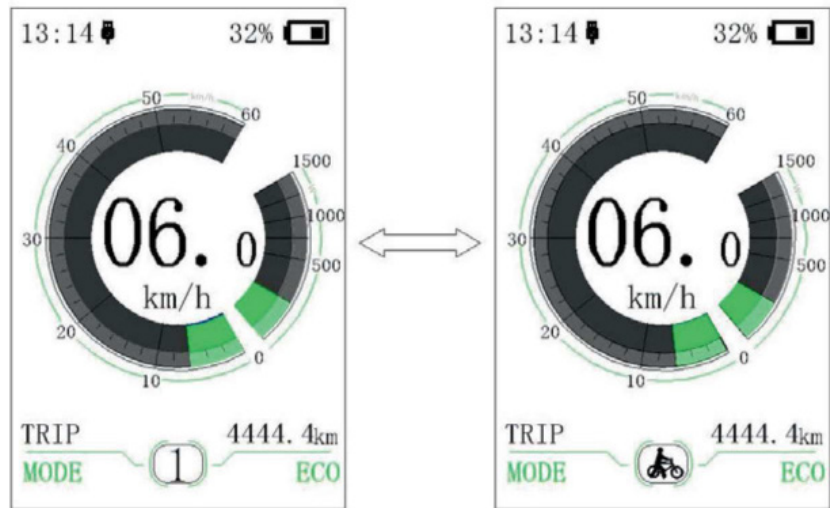

METER PROGRAMMING AND USE

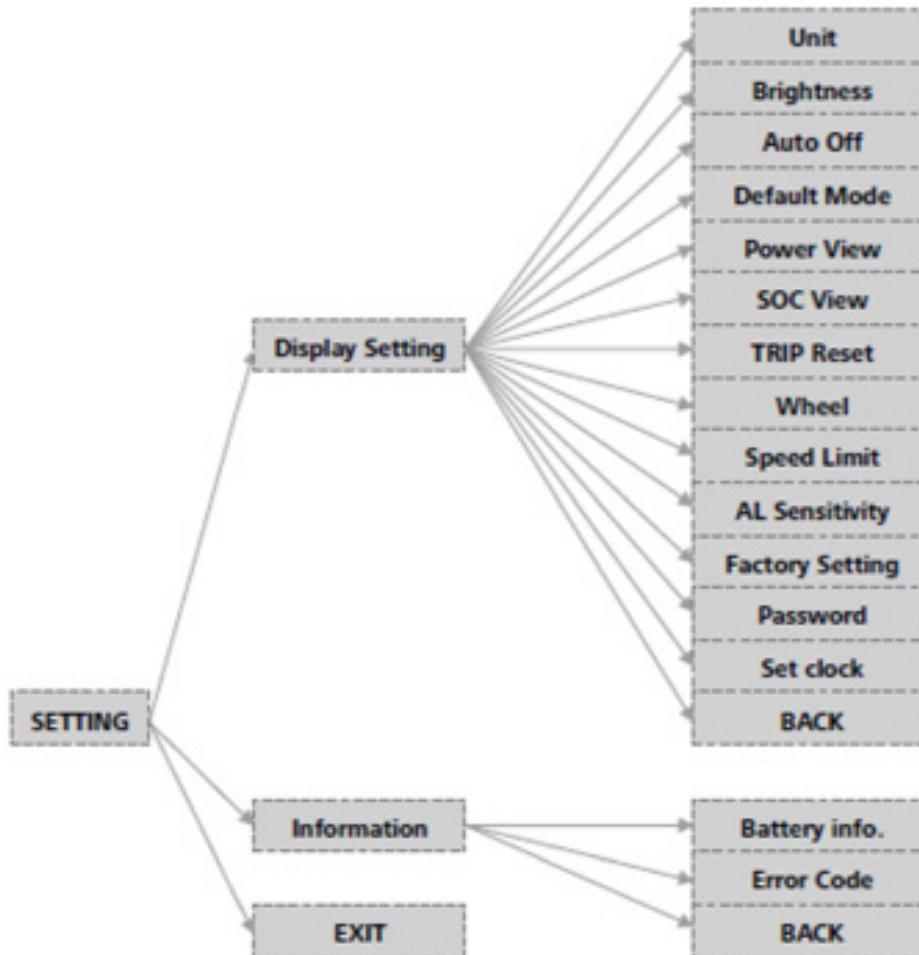

Enter “SETTING” interface

After turning on the display, briefly press (<0.5S) **i** for two times to enter the “SETTING” interface. The interface includes the three options as “Display setting”, “Information” and “EXIT”. Briefly press (<0.5S) **+** or **-** to switch the option and then briefly press (<0.5S) **i** to confirm and enter the option. Select “EXIT” and briefly press (<0.5S) **i** to exit the interface or briefly press (<0.5S) **i** for two times in any interface to exit the set inface. The set dates are saved for the two-exit mode. If there is not any operation within 20s and then exit the set interface, no dates are saved.

Enter “Display setting” interface

In “SETTING” interface, briefly press (<0.5S) **+** or **-** to select “Display setting” and then briefly press (<0.5S) **i** to confirm and enter into “Display setting”. There are thirteen set options in the interface.

(1) “Unit” - unit switch between the km and mile

Briefly press (<0.5S) **+** or **-** to select “Unit”, and then briefly press (<0.5S) **i** to enter the set interface. Briefly press (<0.5S) **+** or **-** to select “Metric”/ “Imperial”, and then briefly press (<0.5S) **i** to save the set and exit back to “Unit” interface. Briefly press **i** for two times (interval time is less than 0.5S) to exit back to main interface or select “BACK” > “EXIT” to exit back to the main interface.

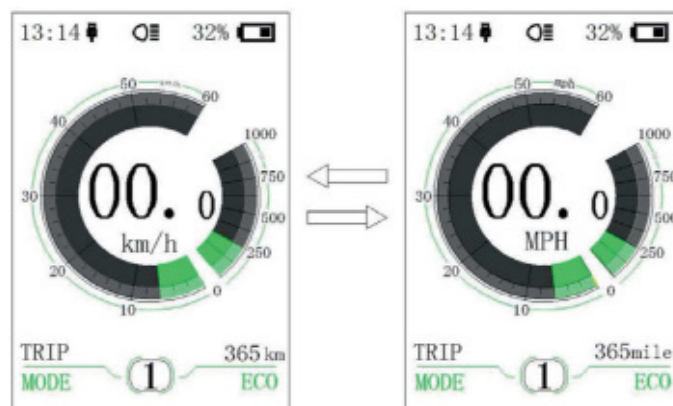

(2) “Brightness” - set display brightness

Briefly press (<0.5S) **+** or **-** to select “Brightness” and then briefly press (<0.5S) **i**. This moment, briefly press (<0.5S) **+** or **-** to switch the percentage as “100%”/ “75%”/ “50%”/ “30%”/ “10%”. 100% is the highest brightness, 10% is lowest brightness. After select the brightness percentage, briefly press (<0.5S) **i** to save the set and exit back to “Brightness”. Briefly press **i** for two times (interval time is less than 0.5S) to exit back to main interface or select “BACK” > “EXIT” to back the main interface.

[3] “Auto Off”- set automatic Off time

Briefly press (<0.5S) **+** or **-** to select “Auto Off”, and then briefly press (<0.5S) **i**. This moment, briefly press (<0.5S) **+** or **-** to switch automatic Off time as “OFF”/“9”/“8”/“7”/“6”/“5”/“4”/“3”/“2”/“1”. The unit is minute. After selection, briefly press (<0.5S) **i** to save the set and exit back to “Auto Off”. Briefly press **i** two times (interval time is less than 0.5S) to exit back to main interface or select “BACK” > “EXIT” to exit back to main interface.

[4] “Default mode”- set riding mode for starting up

Briefly press (<0.5S) **+** or **-** to select “Default Mode”, and then briefly press (<0.5S) **i**. This moment, briefly press (<0.5S) **+** or **-** to switch default riding mode for starting up as “ECO”/ “Sport”. After confirmation, briefly press (<0.5S) **i** again to save the set and exit back to “Default Mode”. And then briefly press **i** two times (interval time is less than 0.5S) to exit back to main interface or select “BACK” > “EXIT” to exit the main menu.

[5] “Power View”- set output display mode

Briefly press (<0.5S) **+** or **-** to select “Power View”, and then briefly press (<0.5S) **i**. This moment, briefly press (<0.5S) **+** or **-** to switch the output display mode as “Power”/“Current”. After confirmation, briefly press (<0.5S) **i** again to save the set and exit back to “Power View”. Briefly press **i** two times (interval time is less than 0.5S) to exit back to the main interface or select “BACK” > “EXIT” to exit back the main interface.

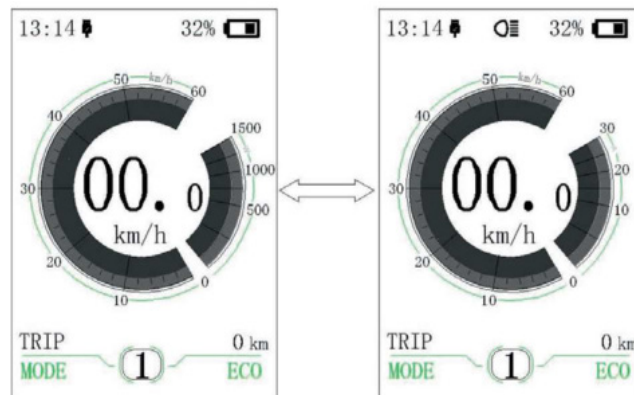

(6) "SOC View" - set display mode for battery level

Briefly press (<0.5S) **+** or **-** to select "SOC View", and then briefly press (<0.5S) **i**. This moment, briefly press (<0.5S) **+** or **-** to switch display mode for output as "Percent"/"Voltage". After confirmation, briefly press (<0.5S) **i** to save the set and exit back to "SOC View". Briefly press **i** two times (interval time is less than 0.5S) to exit back to the main interface or select "BACK" >"EXIT" to exit back to the main menu.

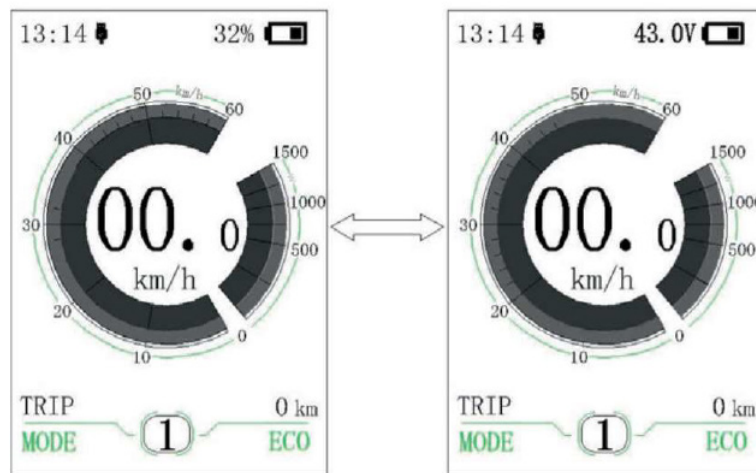







(7) "TRIP Reset" - set reset function for single-trip distance

Briefly press (<0.5S) **+** or **-** to select "TRIP Reset", and then briefly press (<0.5S) **i**. This moment briefly press (<0.5S) **+** or **-** to switch between "NO" and "YES". TRIP Reset includes maximum speed (MAXS), average speed (AVG), single-trip distance (TRIP). After confirmation, briefly press (<0.5S) **i** again to save the set and exit back to the "TRIP Reset". Briefly press **i** two times (interval time is less than 0.5S) to exit the main interface or select "BACK">"EXIT" to exit back to the main interface. The data is not reset automatically when turn off the display or turn off the power of the bicycle.







(8) "Wheel" - set the wheel diameter

Briefly press (<0.5S) **+** or **-** to select "Wheel", and then briefly press (<0.5S) **i**. This moment, briefly press (<0.5S) **+** or **-** to select the wheel diameter as "6"/"7"/"8"/...../"32"/"33"/"34". After confirmation, briefly press (<0.5S) **i** to save the set and exit back to "Wheel". Briefly press **i** two times (interval time is less than 0.5S) to exit back to main interface or select "BACK" > "EXIT" to exit back to main menu.







(9) “Speed Limit” - set speed limit

Briefly press (<0.5S)  or  to select “Speed Limit” and then briefly press (<0.5S) . This time, briefly press (<0.5S)  or  to select the number as “10”/“11”/“12”/...../“58”/“59”/“60”. After confirmation, briefly press (<0.5S)  to save the set value and exit back to “Speed Limit”. Briefly press  two times (interval time is less than 0.5S) to exit back to main interface or select “BACK”>“EXIT” to exit back to main interface.

(10) “AL Sensitivity” - set light sensitivity

Briefly press (<0.5S)  or  to select “AL Sensitivity” and then briefly press (<0.5S) . This moment, briefly press (<0.5S)  or  to switch level of the light sensitivity between “0”/“1”/“2”/“3”/“4”/“5”/“OFF”. “OFF” means close the function. Level 1 is the weakest light sensitivity and level 5 is the strongest light sensitivity. Select the level desired and briefly press (<0.5S)  again to save the setting and exit back to “AL Sensitivity”. Briefly press  two times (interval time is less than 0.5S) to exit back to main interface or select “BACK” > “EXIT” to exit back to main interface.

(11) “Factory Setting”- Restore factory Settings

Briefly press (<0.5S)  or  to select “Factory Setting” and then briefly press (<0.5S) . This moment, briefly press (<0.5S)  or  to select “YES” / “NO”. Select “YES” and briefly press (<0.5S) . When display the “OK”, it means it is successful to restore the factory setting. Briefly press for two times(interval time is less than 0.5S) to exit back to main interface or select “BACK” > “EXIT” to exit the main interface.

(12) "Password"- boot password setting

Briefly press (<0.5S) **+** or **-** to select "Password" and then briefly press (<0.5S) **i**. This moment, briefly press (<0.5S) **+** or **-** to select "Start Password" and then briefly press (<0.5S) **i** or to switch between "OFF" / "ON", the below is the specific way of switching. Starting password: Enter "Start Password" interface and select "ON". Briefly press (<0.5S) **i**, and then it shows input password in the interface.

This moment, briefly press (<0.5S) **+** or **-** to switch numbers "0-9", and then briefly press (<0.5S) **i** to confirm input number. After input, it shows input password again in the interface. Repeat the above step to input password again. If the password is same with the previous time, the system will prompt it is successful to set password, otherwise it need to repeat the first step to input the new password and then re-confirm.

After setting the password, the interface exit back automatically to original interface within two seconds. Briefly press **i** for two times (interval time is less than 0.5S) to exit back to main interface or select "BACK" > "EXIT" to exit back to main interface.

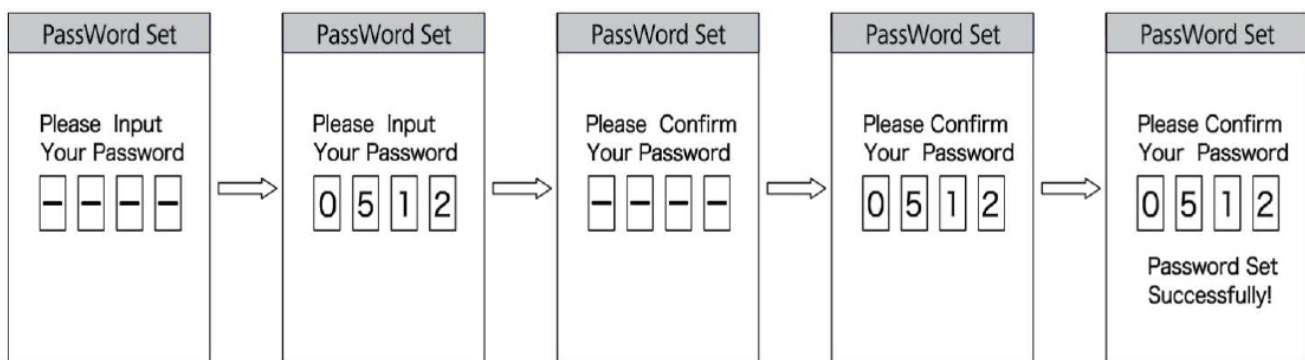

Change password

After setting the password, the interface "Password" will add option "Reset Password". Briefly press (<0.5S) **+** or **-** to select "Reset Password", and then briefly press (<0.5S) **i**. This time it prompt input current password in the interface. If inputting wrong password for ten times, the display will turn off automatically. When inputting right password, it prompt input new password in the interface. The following step is same with starting password. After changing the password, it will exit automatically back to the original interface within two seconds.

Briefly press **i** two times (interval time is less than 0.5S) to exit back to the main interface or select "BACK" > "EXIT" to exit back to main interface.

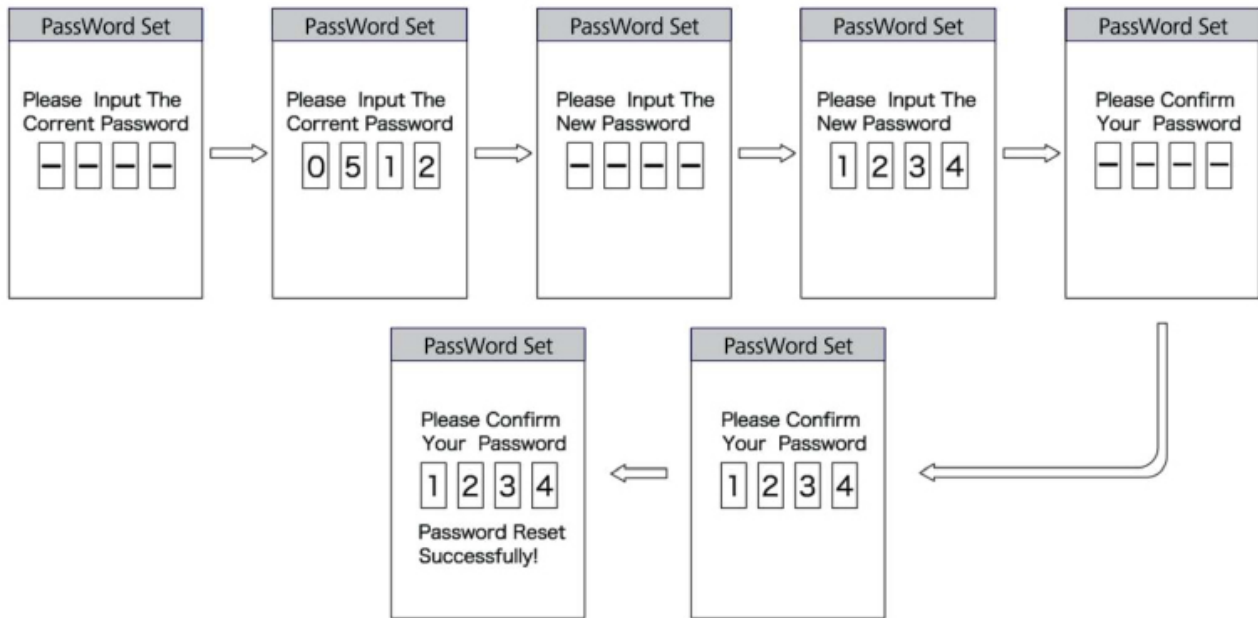

Close password

Enter “Start Password” interface to select “OFF” and then briefly press [$<0.5S$] **i**. This moment, it prompt input password in the interface. If inputting wrong password for ten times, the display will turn off automatically. After inputting right password, it prompts it is successful to close password in the interface. Two seconds later, it exits back automatically to the original interface. Briefly press **i** two times (interval time is less than 0.5S) to exit back to the main interface or select “BACK” > “EXIT” to exit the main interface.

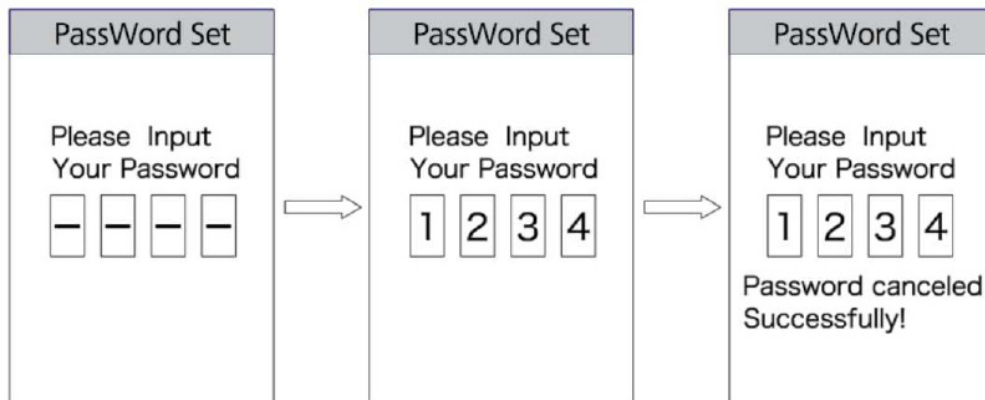

(13) "Set Clock"- time setting

Briefly press (<0.5S) **+** or **-** to select "Set Clock" and then briefly press (<0.5S) **i**. The time is represented in the 24-hour system. Cursor stays at the first digit of the clock. Briefly press **+** or **-** to select "0-2" and then briefly press (<0.5S) **i** to confirm the selection. This moment, the cursor switch to the second digit of the clock. Briefly press **+** or **-** to select "0-9", and then briefly press (<0.5S) **i** to confirm the selection. And the cursor will switch to the first digit of the minute. Briefly press **+** or **-** to select "0-5", and then briefly press (<0.5S) **i** to confirm the selection. The cursor will switch the second digit of the minute, and then briefly press (<0.5S) **+** or **-** to select "0-9". Briefly press (<0.5S) **i** to save the selection and exit back to "Set Clock". Briefly press **i** two times (interval time is less than 0.5S) to exit back to the main interface or select "BACK" > "EXIT" to exit back to the main interface.

Error code definition

i DP C18.UART display can show e-bike faults. When a fault is detected, the icon **i** will be displayed. One of the following error codes will be displayed.

Error code	Error definition	Solution
07	High voltage protection	Check the battery voltage
08	Fault with motor hall sensor inside	Have your dealer check the motor stator
10	The motor temperature reaches to the max protection value	Stop riding and wait until the LED stop flickering
12	Fault with current sensor inside controller	Have your dealer check the controller
13	Fault with temperature sensor inside battery	Check the battery
21	Fault with wheel speed detecting sensor	Check the motor stator
22	BMS Communication fault	Replace the battery
30	Communication fault	1. Check the connectors between the EB-BUS and the controller 2. Replace the controller

WARNINGS AND SAFETY

You should check the operation of your brake inhibitor switches before every ride. While riding slowly in a controlled environment (like a driveway), engage the motor, then squeeze each brake in turn. The motor should lose power immediately and remain off as long as a brake lever is depressed.

Always use the lowest assist setting until you are comfortable with the bike and feel confident controlling the electric assist.

Keep your hands on the brake levers and remember that they will always slow or stop the bike if pulled.

Use only the battery provided with your bicycle. Even if it is physically possible to connect another type of battery, it is dangerous and potentially damaging to do so.

Never short circuit on the discharge terminals of the battery. A short circuit will damage the battery and could cause a fire resulting in severe injury or death, and property damage. When handling the battery outside the bicycle, be aware of conductive materials that may short the battery terminals, such as coins, nails, etc.

Electric bikes are faster and heavier than normal bikes. When riding in wet weather, you should use extra caution.

Local laws may prohibit the use of high-speed electric bicycles on bike paths or trails. Be sure you are familiar with the laws in your area. Even if legal, it is usually not safe to ride at high speed on paths or trails around other users.

Like any mechanical device, a bicycle and its components are subject to wear and stress. Different materials and mechanisms wear or fatigue from stress at different rates and have different life cycles. If a component's life cycle is exceeded, the component can suddenly and catastrophically fail, causing serious injury or death to the rider.

Scratches, cracks, fraying, and discoloration are signs of stress-caused fatigue and indicate that a part is at the end of its useful life and needs to be replaced.

Electric Bikes can be dangerous to use. The user or consumer assumes all risk of personal injuries, damage, or failure of the bicycle or system and all other losses or damages to themselves and others and to any property arising because of using this bicycle.

Website: www.demonelectric.ca
Address: 25 A East Pearce St Unit 2,
Richmond Hill, ON L4B 2M9
Toll Free: 1-855-373-4685
Telephone: 905 881 9510