

Each kit will include 2 x 4' curved panels, frame, netting and all connectors

VEGGIE WALL

Stack & **Extend

- Used with *curved raised bed

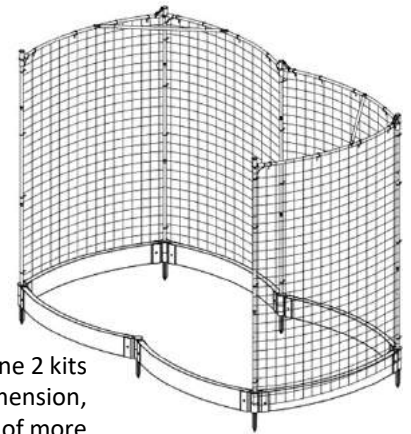

**Extendable – combine 2 kits to expand to any dimension, requires 2 kits of more

KIT CONTAINS:

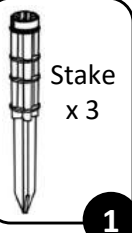
- 

Stake x 3

1
- **Use Stake if you install veggie wall directly in the ground*
- 

Adapter Caps x 3

2
- 

Cotter Pin x 2

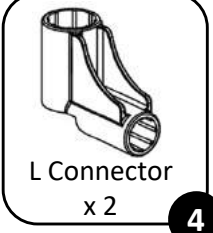
3
- 

L Connector x 2

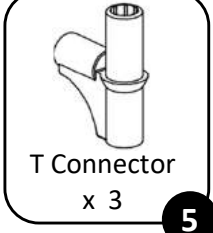
4
- 

T Connector x 3

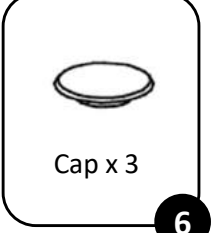
5
- 

Cap x 3

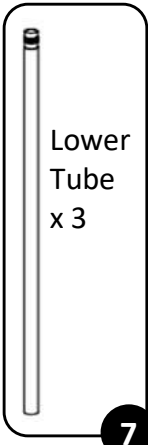
6
- 

Lower Tube x 3

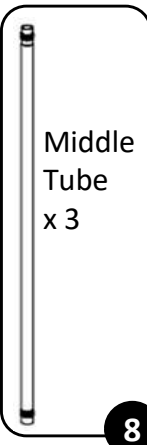
7
- 

Middle Tube x 3

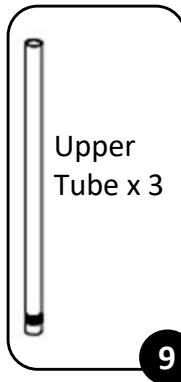
8
- 

Upper Tube x 3

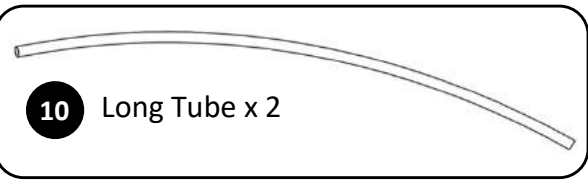
9
- 

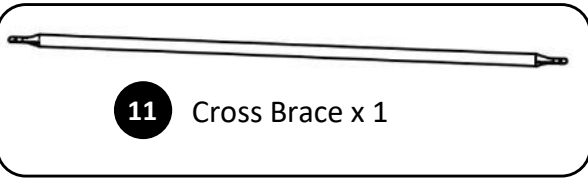
10 Long Tube x 2
- 

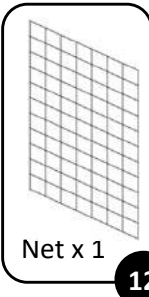
11 Cross Brace x 1
- 

Net x 1

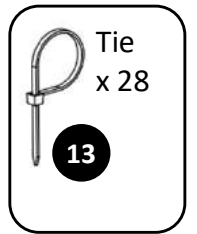
12
- 

Tie x 28

13

ASSEMBLY INSTRUCTIONS

STEP 1:

Screw the short upper tube **9** into the middle tube **8** and tighten. Screw lower tube **7** into the connected tubes **8** and **9**, tighten to complete one upright pole. Repeat to build the other two upright poles.

STEP 2:

Place T-connector **5** into one end of each horizontal tube **10**. To connect the two horizontal poles, join T-connector **5** and L-connector **4** to produce the corner hinge. Place the two ends of horizontal pole **10** without connectors into this connection hinge.

Place this assembly onto ground to attach the cross brace **11**. Make sure the open connector holes are facing down. Position cross brace **11** over the pre-drilled holes on both horizontal tubes **10**.

Connect brace **11** onto horizontal tube **10** by pushing the cotter pin **3** through the cross brace and pre-drilled holes in the tubes, then bend the pins to create snug fit.

Place the adapter cap **6** on each connection point.

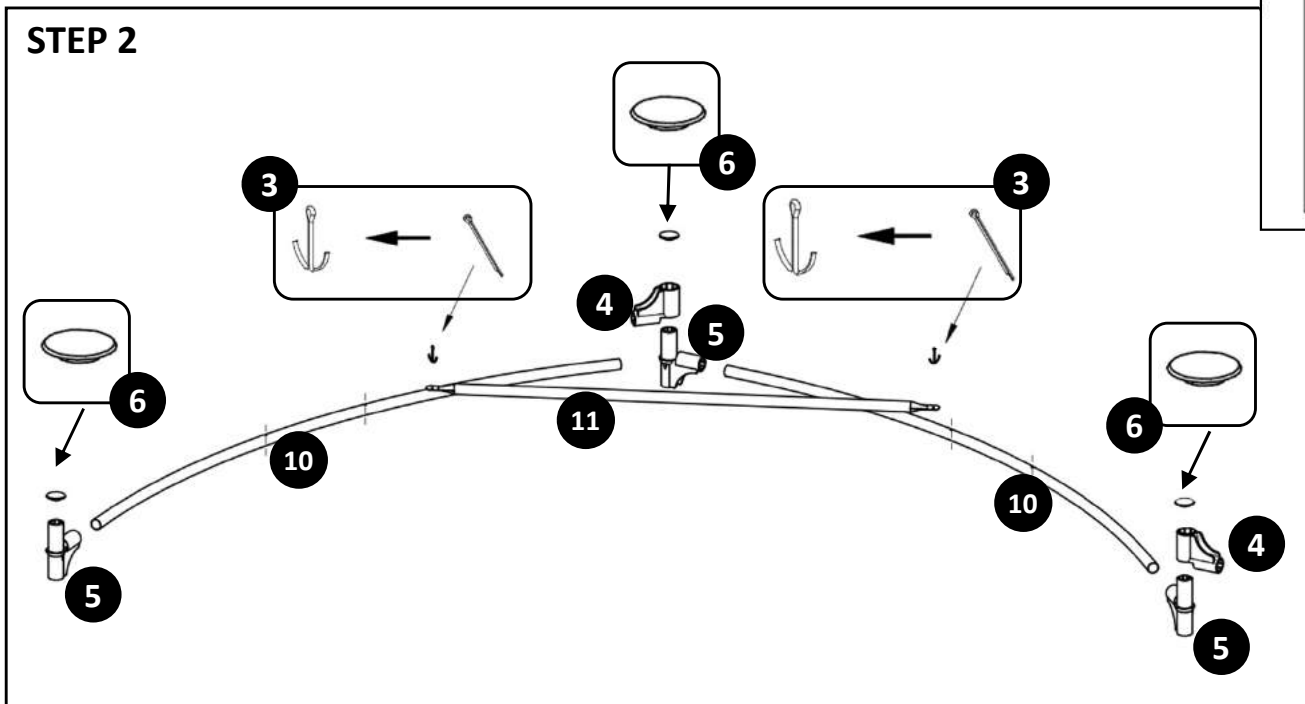
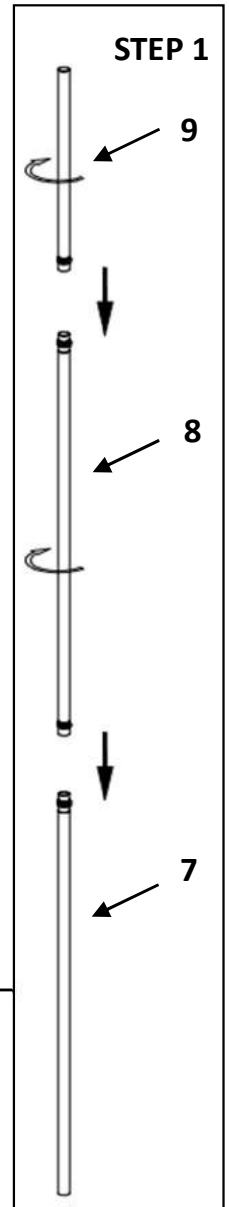

ASSEMBLY INSTRUCTIONS

STEP 3:

Take the entire assembled top frame and insert on top of the 3 vertical poles. If you are placing this into an already built raised garden utilize the stake cover hole **2** and slide the vertical poles through the stake cover into the stake (see STEP 4 Image)

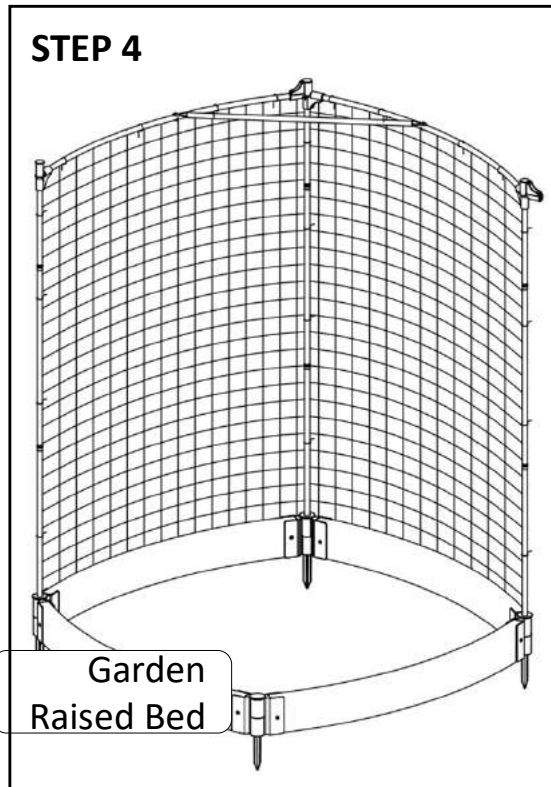
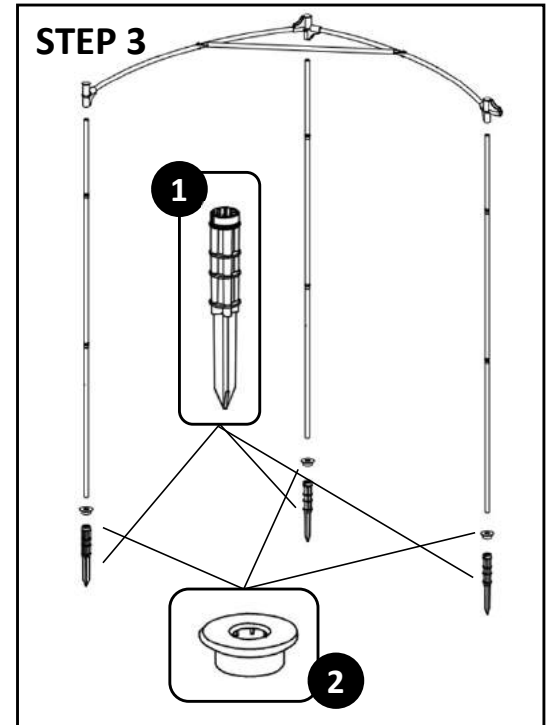

STEP 4:

Open the green net **12** completely. Use cable ties to affix the net onto the frame, making sure to equally space the cable ties along the tubes. Start at the top affixing 5 ties to each of the horizontal tubes and then affixing 6 ties to each of vertical tubes.

OPTIONAL

To attach a second veggie wall to the same garden bed, attach a cap, one L-connector **4** to a T-connector **5** as show in the diagram on the right. When you do this, one vertical tube is not needed.

