

# VEGGIE WALL

## Stack & Extend

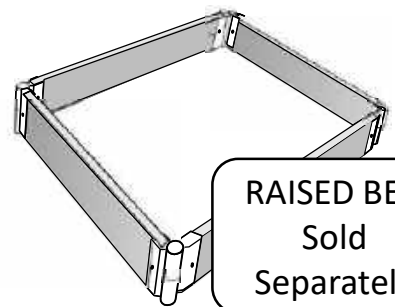

RAISED BED  
Sold  
Separately

### KIT CONTAINS:

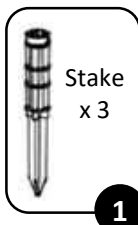

\*\*Use Stake  
if you install  
veggie wall  
directly in the  
ground

1



2



3

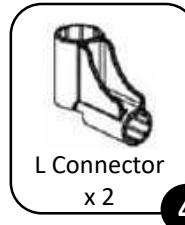

4

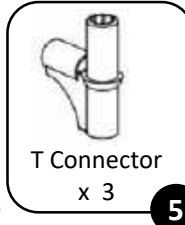

5

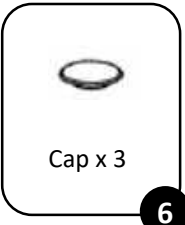

6

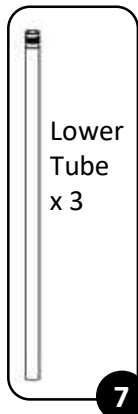

7

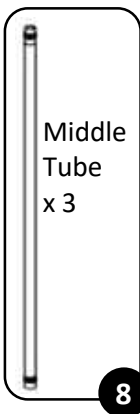

8

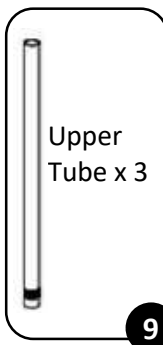

9

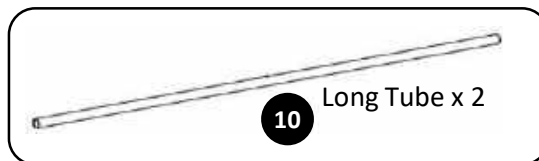

10

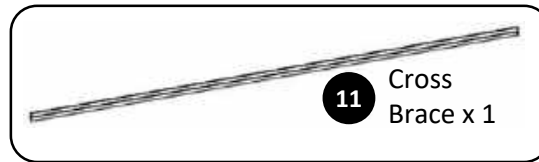

11

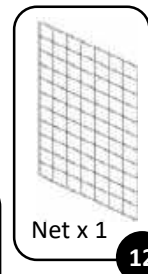

12

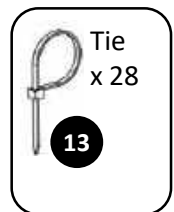

13

# ASSEMBLY INSTRUCTIONS

## STEP 1:

Screw the short upper tube **9** into the middle tube **8** and tighten. Screw lower tube **7** into the connected tubes **8** and **9**, tighten to complete one upright pole. Repeat to build the other two upright poles.

## STEP 2:

Place T-connector **5** into one end of each horizontal tube **10**. To connect the two horizontal poles, join T-connector **5** and L-connector **4** to produce the corner hinge. Place the two ends of horizontal pole **10** without connectors into this connection hinge.

Place this assembly onto ground to attach the cross brace **11**. Make sure the open connector holes are facing down. Position cross brace **11** over the pre-drilled holes on both horizontal tubes **10**.

Connect brace **11** onto horizontal tube **10** by pushing the cotter pin **3** through the cross brace and pre-drilled holes in the tubes, then bend the pins to create snug fit.

Place the adapter cap **6** on each connection point.

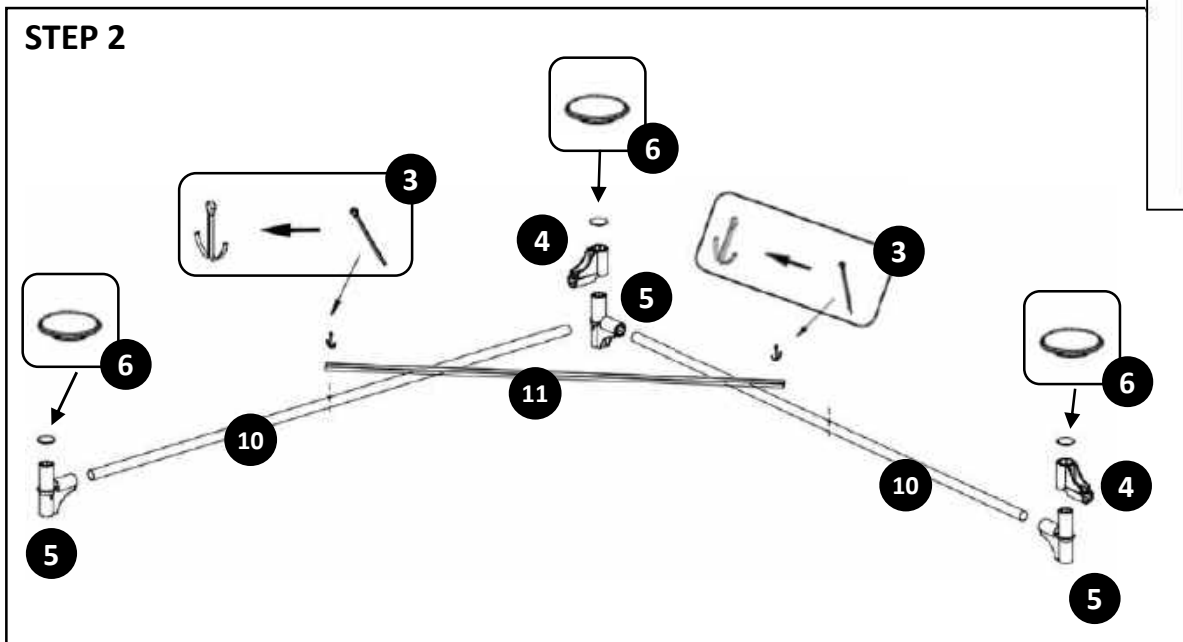
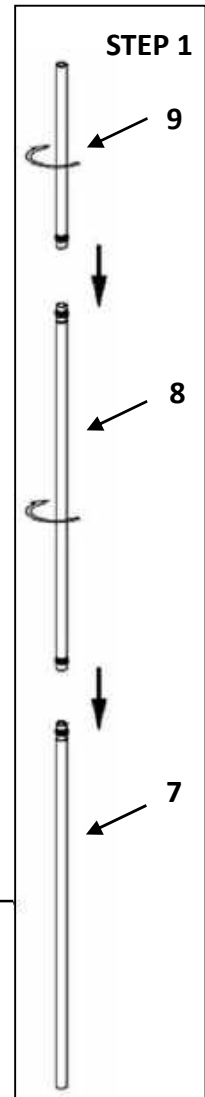

# ASSEMBLY INSTRUCTIONS

## STEP 3:

Take the entire assembled top frame and insert on top of the 3 vertical poles. If you are placing this into an already built raised garden utilize the stake cover hole **2** and slide the vertical poles through the stake cover into the stake (see STEP 4 Image)

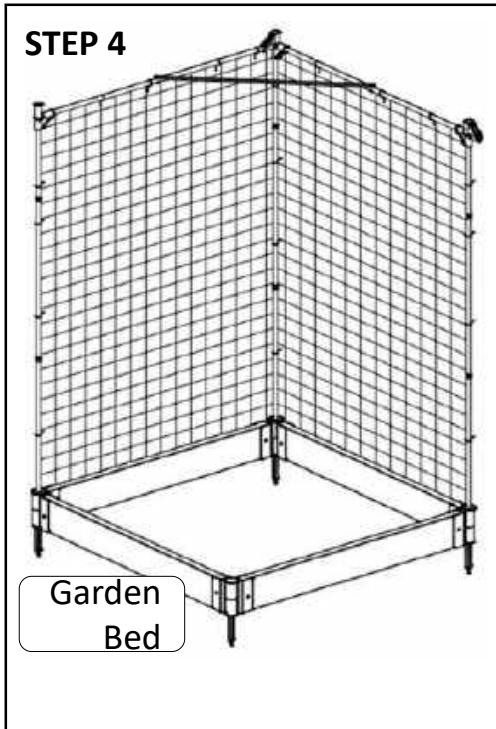
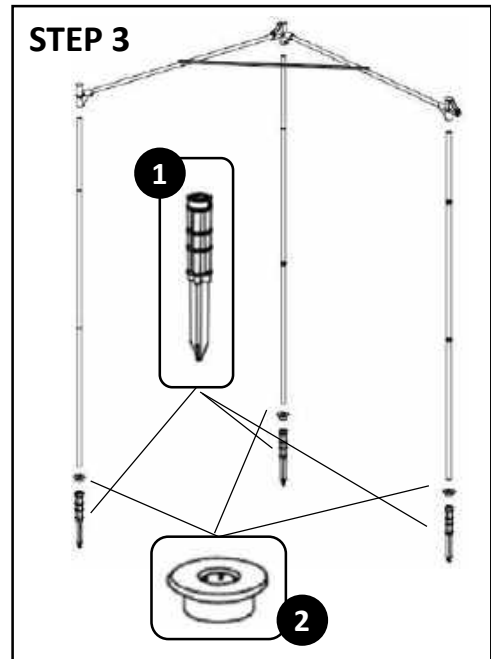

## STEP 4:

Open the green net **12** completely. Use cable ties to affix the net onto the frame, making sure to equally space the cable ties along the tubes. Start at the top affixing 5 ties to each of the horizontal tubes and then affixing 6 ties to each of vertical tubes.

## OPTIONAL

To attach a second veggie wall to the same garden bed, attach one L-connector **4** to a T-connector **5** as show in the diagram on the right, When you do this, one vertical tube is not needed.

