

CONTENTS

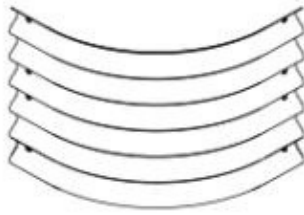

Side Panel
x8



Corner Panel
x4

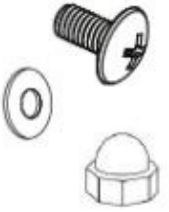

Cap, Bolt, Washer
Set x48

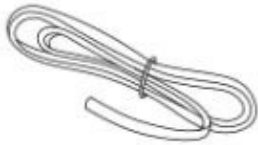

Rubber Edging
Strip x1



Hand wrench
x1

CONFIGURATION

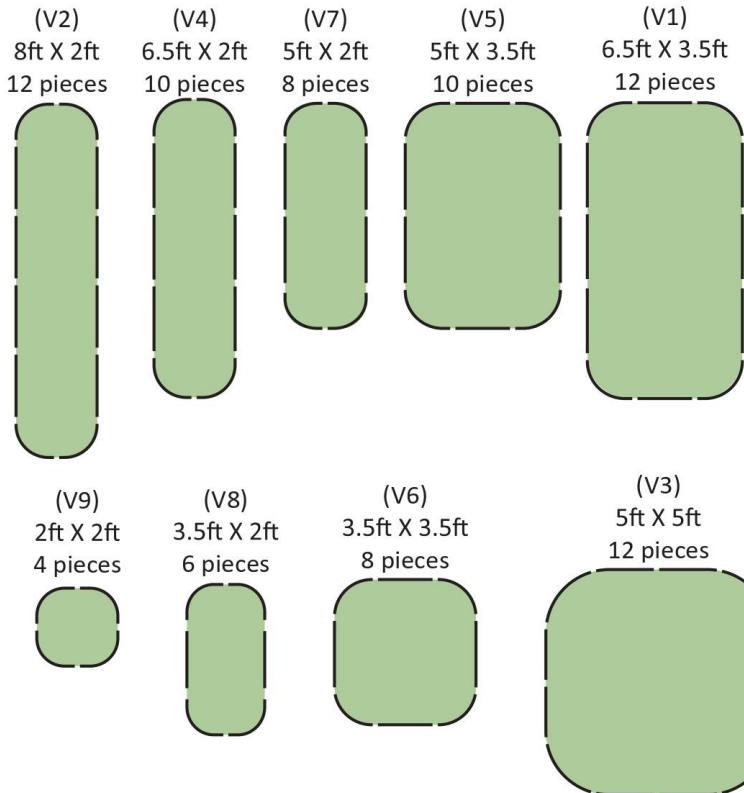

Configuration	Cubic Yards
V1	1.06
V2	0.74
V3	1.16
V4	0.60
V5	0.80
V6	0.56
V7	0.44
V8	0.30
V9	0.16

ASSEMBLY GUIDE

Caution: Metal panels have sharp edges and may cause injury. Using protective gear (gloves, closed toed shoes, etc.) is recommended.

1. Lay in desired configuration on a flat surface (Be mindful that paint may scratch if laid on rough surfaces).

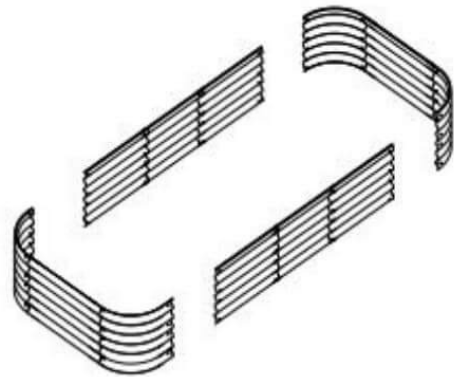

2. Loosely, assemble all straight panels with the bolt, washer and nut. Use the hand wrench to tighten.

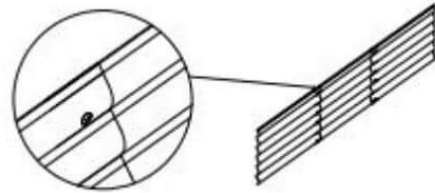

3. Attach corner panels on the outside of the straight panels and tighten all nuts.

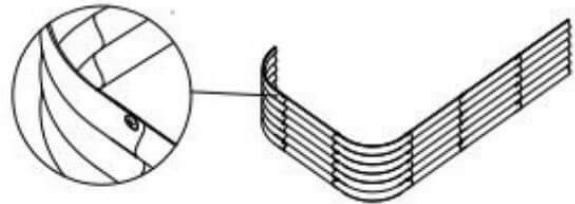

4. Push on rubber edging to the top edge of the box and cut off remainder.

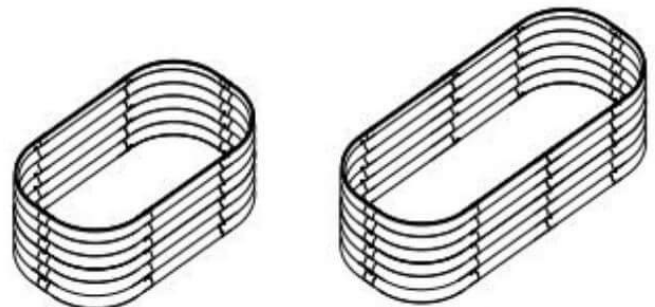

17" 2in1

17" 4in1

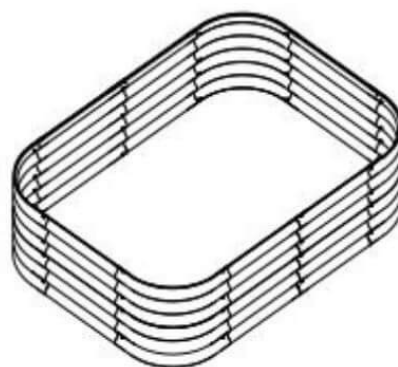

17" 6in1

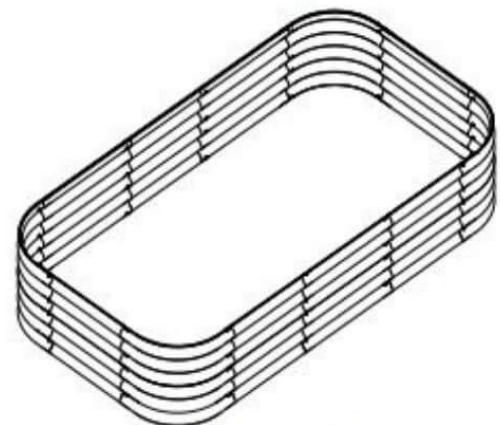

17" 9in1