

ROMEO & JULIET

© design by *stijn goethals, koen baeyens & basile graux*

READ INSIDE

ASSEMBLY INSTRUCTIONS,
HOW TO USE, USEFUL TIPS
FOR KEEPING YOUR TOOL FOR
TOGETHERNESS IN SHAPE

LANGUAGES

EN – NL – DE – FR – IT – ES

MORE

WWW.EXTREMIS.BE

PRODUCT

ROMEO & JULIET – CONNECTION – MAINTENANCE

LANGUAGES

ENGLISH

P. 3

contents	p. 3
assembly romeo & juliet	p. 4
assembly connection piece	p. 6
maintenance	p. 8

NEDERLANDS

P. 11

inhoud	p. 11
montage romeo & juliet	p. 12
montage koppelstuk	p. 14
onderhoud	p. 16

DEUTSCH

P. 19

inhalt	p. 19
montage romeo & juliet	p. 20
montage Anschluss	p. 22
pflege	p. 24

FRANÇAIS

P. 27

contenu	p. 27
montage romeo & juliet	p. 28
montage pièce de connexion	p. 30
entretien	p. 32

ITALIANO

P. 35

contenuto	p. 35
montaggio romeo & juliet	p. 36
montaggio elemento di raccordo	p. 38
manutenzione	p. 40

ESPAÑOL

P. 43

contenido	p. 43
montage romeo & juliet	p. 44
montage pieza conectora	p. 46
mantenimiento	p. 48

CONTENTS

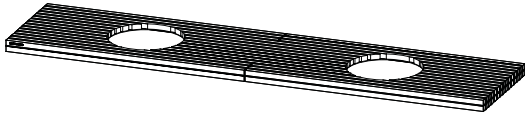

1 x wooden bench

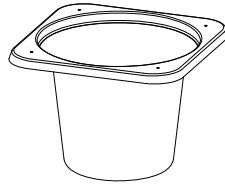

2 x polyester container

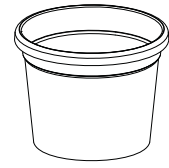

2 x inner container

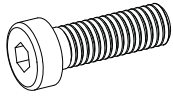

8 x M8x25 bolt

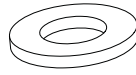

8 x M8 flat washer



8 x M8 nut

OPTIONAL

CONNECTION PIECE

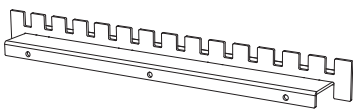

1 x connection piece

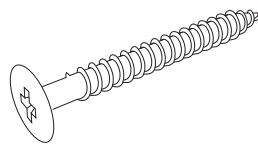

26 x 5x30 screw

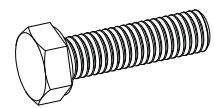

6 x M8x30 bolt



6 x M8 nut



12 x M8 flat washer

ASSEMBLY ROMEO & JULIET

WHAT YOU NEED



2 people



no. 13 spanner



no. 5 hex key



+/- 30 min.

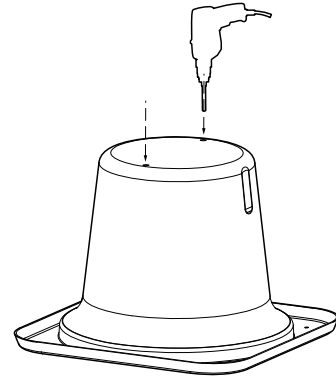

1. If the bench is to be anchored to the ground, drill two holes in each polyester container where indicated.

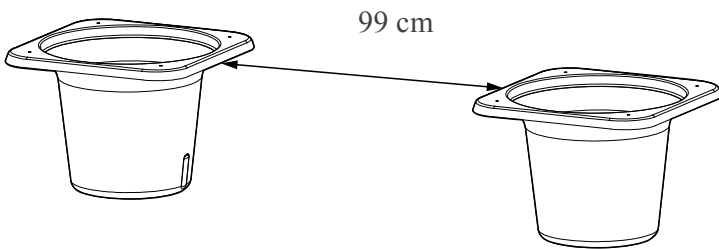

2. Position the 2 polyester containers at the desired spot. Make sure the distance between them amounts to 99 cm. If the bench is to be anchored to the ground, wait until the following step before drilling holes in the ground.

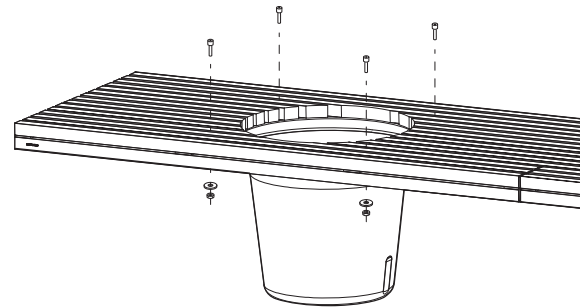

3. Put the wooden bench on top of the 2 containers so that they can be joined together by means of the M8 bolts, the flat washers and the nuts. If required, you can now drill the holes in the ground.

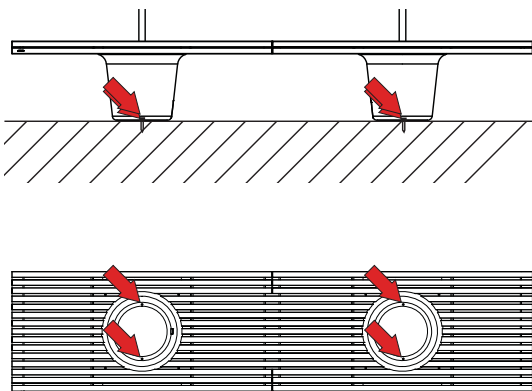

You should buy the appropriate bolts or screws to suit the type of surface concerned yourself. If you want to use the polyester container as a water reservoir, use 4 façade building screws. They will prevent the water from leaking out.

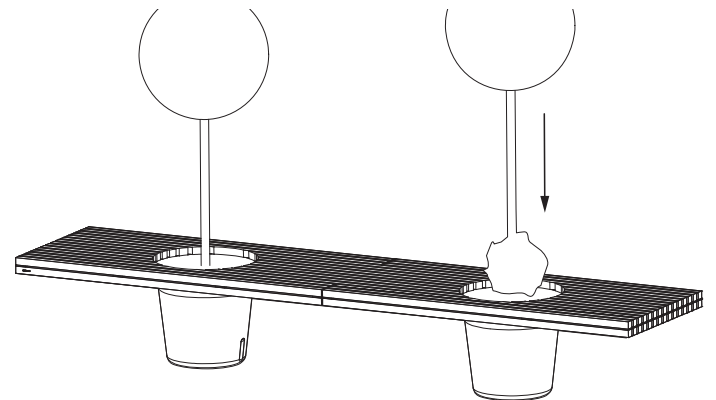

4. Plant the shrubs in the polyester containers (or in the optional inner containers). If desired, put a layer of mulch on top of the soil.

WARNING!

You can plant the shrubs either straight into the polyester containers or in the optional inner containers, thus creating a water reservoir. Not all plants like wet feet though. **Always seek the advice of your plant supplier first.**

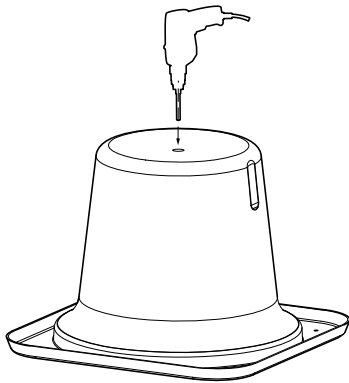

Option A:
Planting straight into the polyester container: Make sure that the excess water can drain away freely by drilling a few holes in the bottom of the container.

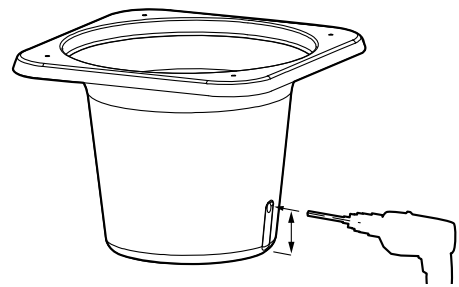

Option B:
Planting in an inner container, creating a water reservoir: Drill an overflow hole in the side of the polyester container 9 cm above the ground to allow excess water to drain away.

OPTIONAL CONNECTION OF # ROMEO & JULIETS

WHAT YOU NEED

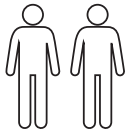

2 people



2 x no. 13 spanner



Torx Tx25 screwdriver



+/- 30 min.



1. If necessary, first remove the wood cubes on the side to which you want to attach the next bench. To this end, turn over the bench, loosen the screws holding the wood cubes in place, and remove the wood cubes. Insert short 5*30 screws into the holes to reattach the metal L-section to the long wooden strips. Turn over the bench. Repeat this operation on all benches you want to connect.



2. Position the first bench on the desired spot and, if necessary, anchor it to the ground. **KEEP IN MIND** that when the benches are connected, it is quite difficult to move them.



3. Fix the connecting piece onto the side to which you want to attach the next bench.

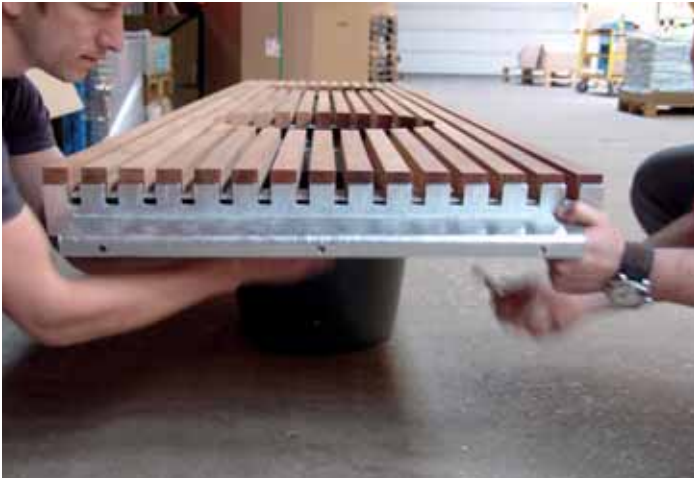

4. Screw the connecting piece down using the supplied bolts. Use a flat washer on both sides and do not fully tighten the bolts at this stage.



5. Put the second bench against the first one, as shown in the pictures above.



6. Fix the second bench onto the connecting piece using the bolts. Do not fully tighten them at this stage.

MAINTENANCE

JATOBA

Jatoba wood requires little or no maintenance. However, we strongly advise you to remove persistent dirt. To clean the wood you can use special products (www.rmc-extremis.be) or simply a stiff bristle brush and some water. Be careful not to irreparably damage the wood fibres. For this reason, **never use a high pressure cleaner** as this will roughen the wood's smooth surface and irreparably damage the wood's fibres.

At first, the wood will give off this red dye every time it comes into contact with water. The dye that drips onto the frame and the surface will remain water-soluble and will disappear entirely after a while.

We strongly recommend that you treat your wood for indoor use with wood oil to protect it from stains.

When delivered, the wooden parts of our products are **untreated**. Exposure to sun and rain will gradually change their colour to silvery grey, and also roughen the surface. If you want to somewhat retain their original colour, you should oil them once a year. We recommend using **RMC Hybrid Wood Protector** (www.rmc-extremis.com). RMC products for wood treatment are available all over the world. Visit the website www.rmc-extremis.com to find a reseller near you.

IMPORTANT!

Wood is a living matter and, in spite of the superior quality provided by jatoba, outdoors it constantly has to adapt to extreme changes in temperature and humidity. Due to internal stress resulting from these constant adaptations the wood "warps". This warping can among other things lead to cracking. Changes in colour or wood structure may also appear. These characteristics are typical of the material and by choosing this material you accept them.

Should any cracks appear, you can simply sand them down either by hand using sandpaper or by means of a hand sander. To protect any galvanised or painted parts, cover the edges with highly robust masking tape. Use 80-grit sandpaper and start at the vertical side of the tabletop. Keep the hand sander parallel to the edge of the tabletop. Lightly sand the edge until it is smooth again. Now sand the rest of the tabletop. Make sure that you always hold the hand sander parallel to the tabletop. Do not only sand the crack, but the entire tabletop to obtain a uniform result. To avoid burrs, sand the top edge of the tabletop by hand. When you have removed all the burrs, you can treat the wood with hardwood furniture oil or leave it untreated, depending on the desired effect.

GALVANISED PARTS

Hot dip galvanisation is the most durable way of protecting metal against rusting. If the zinc coating is damaged, the exposed metal can rust. This can easily be touched up with zinc paint that automatically has the same colour and is generally available in shops.

Galvanisation is a thermal process that can slightly deform the material. Other metal protection methods do not have this disadvantage, but the quality they offer is insufficient.

POLYESTER

Clean with a soft cloth and standard detergents as used to clean the kitchen with. Never clean the flowerpots with abrasive objects, as the polyester is vulnerable to scratches.

Avoid cleaning with a high pressure water jet!

WWW.EXTREMIS.BE

LANGUAGES

ENGLISH

P. 3

contents	p. 3
assembly romeo & juliet	p. 4
assembly connection piece	p. 6
maintenance	p. 8

NEDERLANDS

P. 11

inhoud	p. 11
montage romeo & juliet	p. 12
montage koppelstuk	p. 14
onderhoud	p. 16

DEUTSCH

P. 19

inhalt	p. 19
montage romeo & juliet	p. 20
montage Anschluss	p. 22
pflege	p. 24

FRANÇAIS

P. 27

contenu	p. 27
montage romeo & juliet	p. 28
montage pièce de connexion	p. 30
entretien	p. 32

ITALIANO

P. 35

contenuto	p. 35
montaggio romeo & juliet	p. 36
montaggio elemento di raccordo	p. 38
manutenzione	p. 40

ESPAÑOL

P. 43

contenido	p. 43
montage romeo & juliet	p. 44
montage pieza conectora	p. 46
mantenimiento	p. 48

INHOUD

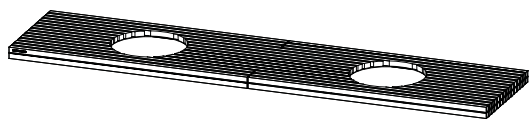

1 x houten bank

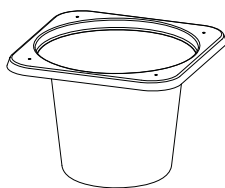

2 x polyesterbak

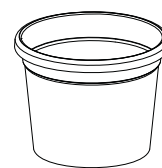

2 x binnepot

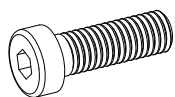

8 x bout M8x25



8 x vlakke sluitring M8



8 x moer M8

OPTIONEEL

KOPPELSTUK

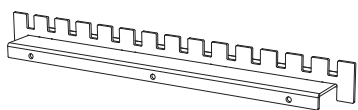

1 x koppelstuk

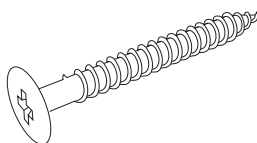

26 x schroef 5x30

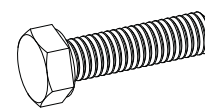

6 x bout M8x30



6 x moer M8



12 x vlakke sluitring M8

MONTAGE ROMEO & JULIET

BENODIGDHEDEN



2 personen



steeksleutel nr. 13



inbussleutel nr. 5



+/- 30 min.

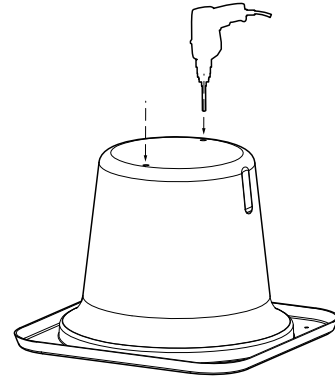

1. Indien de bank aan de ondergrond verankerd moet worden, boor dan per polyesterbak telkens 2 gaten op de aangegeven plaats.

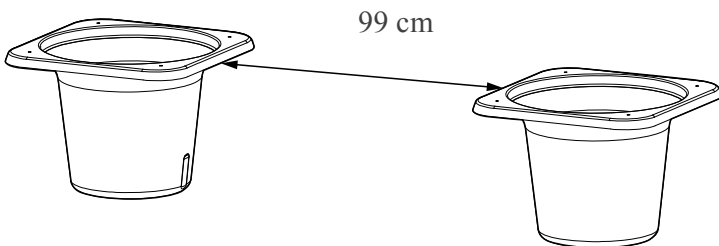

2. Plaats nu de 2 polyesterbakken op de gewenste plaats, met een tussenafstand van 99 cm. Bij grondverankering, wacht tot de volgende stap om gaten te boren in de ondergrond.

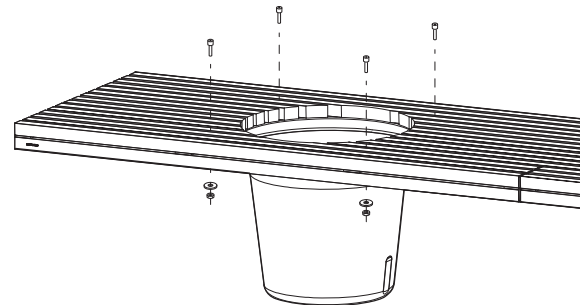

3. Plaats de houten bankstructuur op de 2 bakken, zodat deze aan elkaar kunnen worden bevestigd met behulp van de bouten M8, sluitringen en moeren. Boor nu eventueel de gaten voor grondverankering.

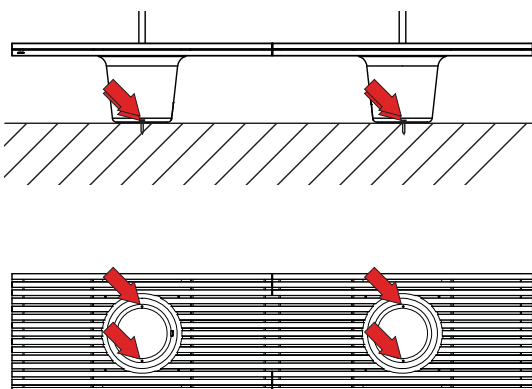

Afhankelijk van de ondergrond dienen bouten of schroeven zelf voorzien te worden. Bij waterreservoir, gebruik 4 gevelschroeven, zodat de gaten waterdicht worden afgesloten.

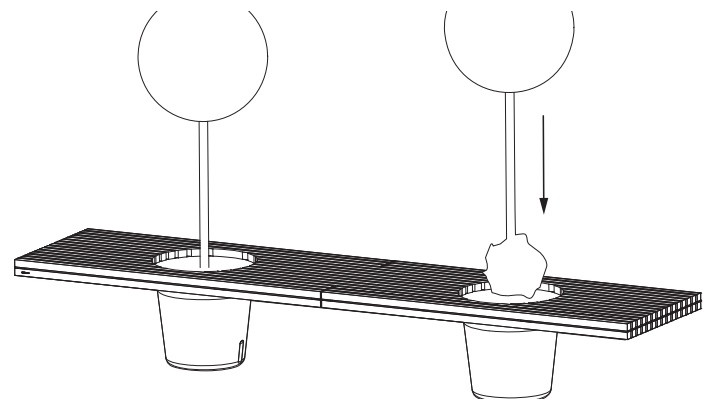

4. Plant nu de boompjes in de polyesterpotten (of de optionele binnenpotten). Bestrooi de aarde indien gewenst met schors.

OPGELET!

Boompjes worden ofwel rechtstreeks in de polyesterbakken geplant, ofwel in de optionele binnenpot waardoor een waterreservoir wordt gecreëerd. Dit is ook afhankelijk van de gekozen planten. **Ga hiervoor te rade bij uw bloemist.**

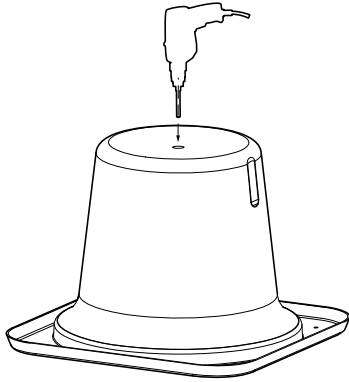

Optie A:
rechtstreeks in polyesterbak: zorg ervoor dat overtollig water kan wegvloeien door het boren van gaten aan de onderzijde

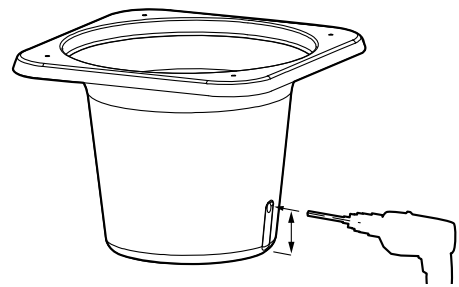

Optie B:
in binnenpot met waterreservoir: op 9 cm van de onderzijde moet een overloopgat geboord worden.

OPTIONELE VERBINDING VAN # ROMEO & JULIETS

BENODIGDHEDEN

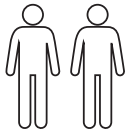

2 personen



2 x steeksleutel nr. 13



Torx Tx25 schroevendraaier



+/- 30 min.



1. Indien nodig moeten de kleine houten blokjes aan de zijde die gekoppeld wordt, eerst verwijderd worden. Plaats hiervoor de bank ondersteboven. Verwijder de schroeven waarmee de kleine blokjes vast zitten en verwijder de blokjes. Draai nu korte schroeven in de gaten die vrijgekomen zijn, zodat het metalen L-profiel terug vast gemaakt wordt met de lange latten. Zet de bank vervolgens opnieuw recht. Doe dit met alle te koppelen banken.



2. Plaats de eerste bank op de juiste plaats en veranker indien nodig. **OPGEPAST**, eens de banken gekoppeld zijn, kun je deze slechts heel moeizaam nog verplaatsen.



3. Monteer het koppelstuk aan de zijde waar je de volgende bank wil koppelen.

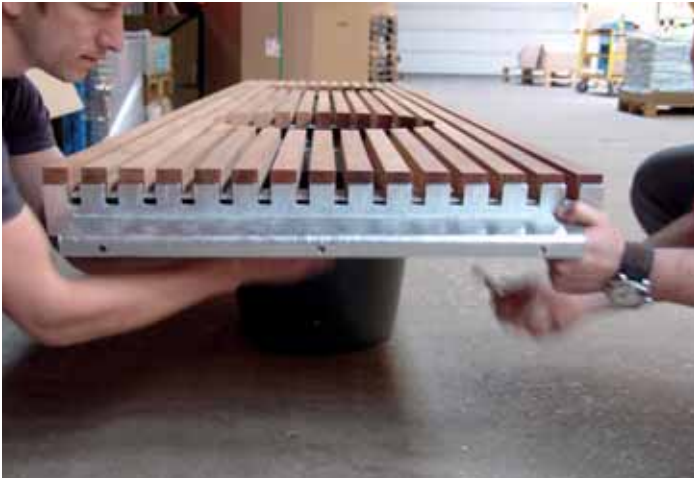

4. Schroef het koppelstuk vast met de meegeleverde boutjes M8. Zorg er steeds voor dat er aan beide zijden een vlakke sluitring zit en dat de boutjes nog niet volledig aangespannen zijn.



5. Plaats nu de 2de bank tegen de 1e bank zoals getoond op de foto's hierboven.



6. Bevestig de 2de bank aan het koppelstuk d.m.v. de boutjes. Span deze nog niet volledig vast.

ONDERHOUD

JATOBA

Jatoba vraagt weinig tot geen onderhoud. Wij raden u echter wel aan om hardnekkige vuilresten te verwijderen. Om het hout te reinigen, kunt u speciale producten (www.rmc-extremis.be) gebruiken of gewoon een harde borstel en wat water. Zorg er echter voor dat u de houtvezels niet beschadigt. Gebruik daarom nooit een hogedrukreiniger. Hierdoor wordt het gladde oppervlak van het hout immers ruwer en raken de houtvezels onherstelbaar beschadigd.

Zoals vele andere houtsoorten bevat Jatoba een wateroplosbare gomstof. In het begin zal het hout deze fel rode kleurstof afscheiden telkens het met water in contact komt. De op het onderstel en de ondergrond afgedropen kleurstof blijft wateroplosbaar en zal na zekere tijd volledig verdwijnen.

We raden ten sterkste aan het hout voor binnen gebruik in te oliën tegen vlekken.

Bij levering zijn de houten onderdelen van onze producten onbehandeld. Door blootstelling aan zonlicht en regen zullen ze geleidelijk een grijs patina krijgen en zal hun oppervlak ook ruwer worden. Als u de oorspronkelijke kleur min of meer wilt behouden, moet u ze jaarlijks oliën. Hiervoor raden wij RMC Hybrid Wood Protector (www.rmc-extremis.com) aan. De houtbeschermingsproducten van RMC zijn overal ter wereld verkrijgbaar. Kijk op www.rmc-extremis.com voor een verkooppunt in uw buurt.

BELANGRIJK!

Hout is een levende materie, en ondanks de superieure kwaliteiten van Iroko, moet het zich buiten steeds aanpassen aan extreme schommelingen van temperatuur en vochtigheid. Hierdoor opgebouwde interne spanningen doet het materiaal “werken” of vervormen en kan er mogelijk o.a. scheurvorming veroorzaken. Ook kunnen er kleuren en structuurverschillen voorkomen.

Deze kenmerken zijn typisch voor het materiaal, die u door uw keuze hiervoor accepteert.

U kan mogelijke scheuren eenvoudig glad schuren met de hand en een vel schuurpapier of met een handschuurmachine. Om de gegalvaniseerde of gelakte onderdelen te beschermen, moet u hun randen vooraf afplakken met stevige afplakband. Gebruik schuurpapier met korrel 80 en begin bij de verticale zijde van het tafelblad. Houd de machine evenwijdig aan de tafelrand. Schuur lichtjes tot de rand weer egaal glad is. Schuur nu het bovenblad. Let er op dat u de machine evenwijdig aan het tafelblad houdt. Behandel niet enkel de gescheurde plaats, maar gans uw blad om een egaal resultaat te bekomen. Om bramen te vermijden schuurt u de bovenste rand van het tafelblad glad. Doe dit deel met de hand. Als alle bramen verwijderd zijn kan u, afhankelijk van het gewenste effect, de tafel inoliën met hardhout olie.

GEGALVANISEERDE ONDERDELEN

Galvanisatie, of thermische verzinking, is de meest duurzame manier om metaal te beschermen tegen roestvorming. Als de zinklaag wordt beschadigd, kan het blootgekomen metaal toch roesten. Dit is eenvoudig bij te werken met zinkverf, die automatisch dezelfde kleur heeft en in de handel verkrijgbaar is.

Galvanisatie is een thermisch proces en kan het materiaal licht vervormen. Andere metaalbeschermingsmethodes hebben dit nadeel niet, maar leveren onvoldoende kwaliteit.

POLYESTERBAK

Te reinigen met een zachte doek en standaard reinigingsmiddelen zoals men ook gebruikt voor de wagen. Vermijd ten allen tijde het gebruik van agressieve reinigingsmiddelen en schuursponsen aangezien polyester krasgevoelig is!

WWW.EXTREMIS.BE

LANGUAGES

ENGLISH

P. 3

contents	p. 3
assembly romeo & juliet	p. 4
assembly connection piece	p. 6
maintenance	p. 8

NEDERLANDS

P. 11

inhoud	p. 11
montage romeo & juliet	p. 12
montage koppelstuk	p. 14
onderhoud	p. 16

DEUTSCH

P. 19

inhalt	p. 19
montage romeo & juliet	p. 20
montage Anschluss	p. 22
pflege	p. 24

FRANÇAIS

P. 27

contenu	p. 27
montage romeo & juliet	p. 28
montage pièce de connexion	p. 30
entretien	p. 32

ITALIANO

P. 35

contenuto	p. 35
montaggio romeo & juliet	p. 36
montaggio elemento di raccordo	p. 38
manutenzione	p. 40

ESPAÑOL

P. 43

contenido	p. 43
montage romeo & juliet	p. 44
montage pieza conectora	p. 46
mantenimiento	p. 48

INHALT

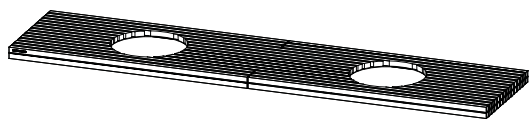

1 x Holzbank

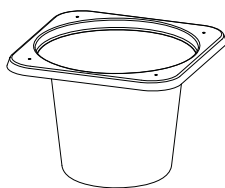

2 x Polyesterkübel

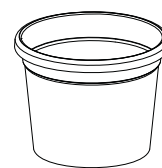

2 x Innentöpfe

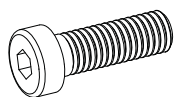

8 x Schraube M8x25



8 x flache Unterlegscheibe M8

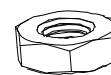

8 x Mutter M8

OPTIONAL

ANSCHLUSS

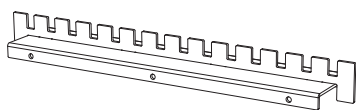

1 x Anschluss

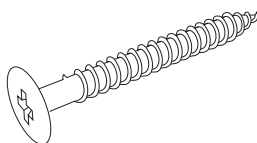

26 x Schraube 5x30

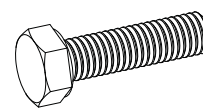

6 x Schraube M8x30



6 x Mutter M8



12 x flache Unterlegscheibe M8

MONTAGE ROMEO & JULIET

WAS SIE BRAUCHEN



2 Personen



Steckschlüssel Nr. 13



Inbusschlüssel Nr. 5



+/- 30 min.

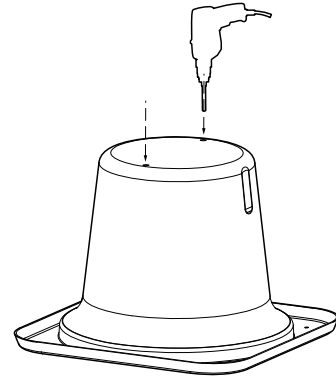

1. Wenn die Bank im Boden verankert werden soll, dann bohren Sie in jeden Polyesterkübel jeweils zwei Löcher an den angegebenen Stellen.

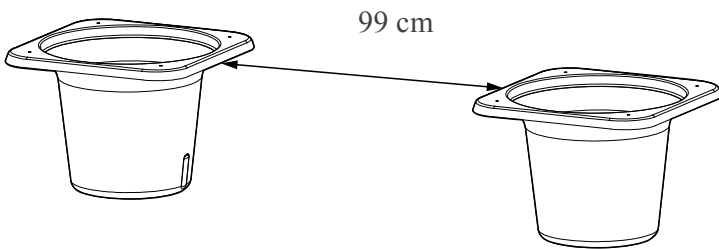

2. Stellen Sie jetzt die beiden Polyesterkübel in einem Abstand von 99 cm an den gewünschten Platz. Bei Verankerung im Boden warten Sie auf den nächsten Schritt, bevor Sie die Löcher in den Boden bohren.

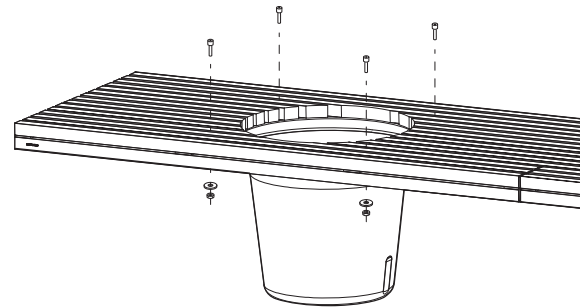

3. Legen Sie die Holzbankkonstruktion auf die beiden Kübel, sodass sie mithilfe der M8-Schrauben, Unterlegscheiben und Muttern darauf befestigt werden kann. Bohren Sie jetzt eventuell die Löcher für die Verankerung im Boden.

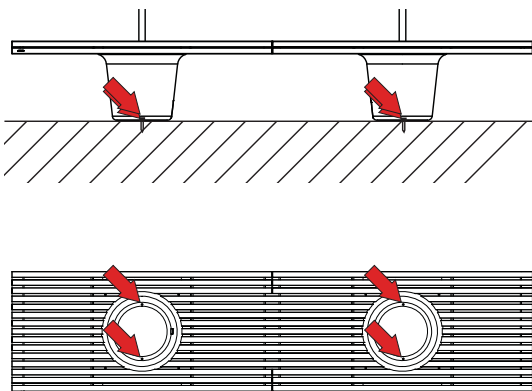

Passend zum Untergrund müssen Bolzen oder Schrauben selbst besorgt werden. Dienen die Kübel als Wasserspeicher müssen Sie vier Fassadenschrauben verwenden, sodass die Löcher wasserdicht sind.

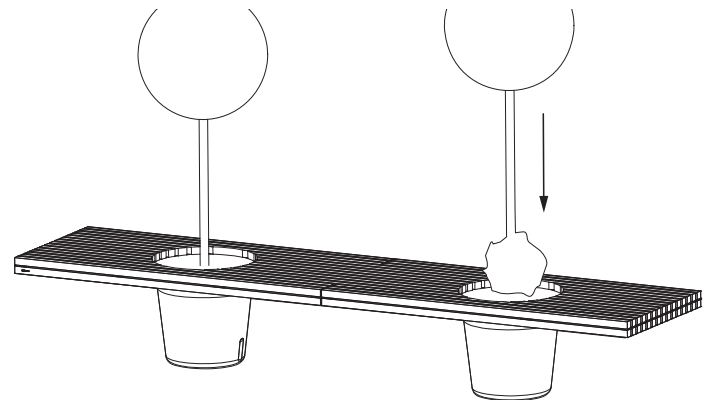

4. Pflanzen Sie jetzt die Pflanzen in die Polyesterkübel oder in die als Option erhältlichen Innentöpfe. Streuen Sie auf Wunsch Rinde auf die Pflanzenerde.

ACHTUNG!

Die Pflanzen werden entweder direkt in die Polyesterkübel gepflanzt oder in die als Option erhältlichen Innentöpfe, wodurch ein Wasserspeicher entsteht. Das hängt von den von Ihnen gewählten Pflanzen ab. **Lassen Sie sich in diesem Zusammenhang von Ihrem Gärtner beraten.**

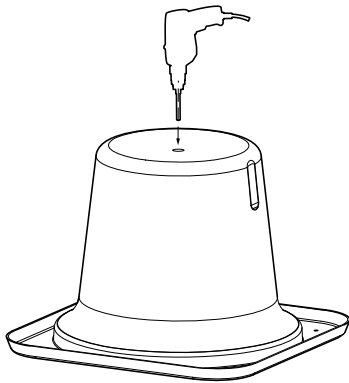

Möglichkeit A:
direkt in den Polyesterkübel: Sorgen Sie dafür, dass überschüssiges Wasser abfließen kann. Bohren Sie dazu Löcher in die Unterseite.

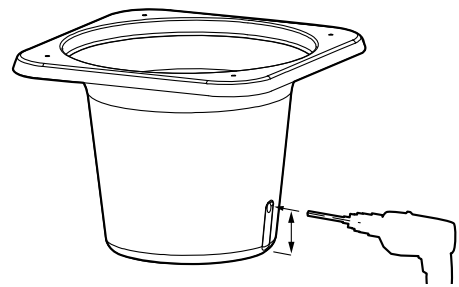

Möglichkeit B:
im Innentopf mit Wasserspeicher: Sie müssen ca. 9 cm vom Boden ein Überlaufloch bohren.

OPTIONAL ANSCHLUSS VON # ROMEO & JULIETS

WAS SIE BRAUCHEN

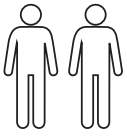

2 Personen



2 x Steckschlüssel Nr.
13



Torx Tx25 Schraubenzieher



+/- 30 min.



1. Falls erforderlich müssen die kleinen Holzstücke an der Seite, an der die Verbindung hergestellt werden soll, erst entfernt werden. Drehen Sie die Bank hierfür um. Entfernen Sie die Schrauben, mit denen die kleinen Holzstücke befestigt sind und auch die Holzstücke selbst. Schrauben Sie jetzt kurze Schrauben 5*30 in die freien Löcher, sodass das L-förmige Metallprofil wieder an den langen Latten befestigt werden kann. Drehen Sie die Bank danach wieder richtig herum. Verfahren Sie mit allen Bänken, die miteinander verbunden werden sollen, auf dieselbe Weise.



2. Stellen Sie die erste Bank auf die gewünschte Stelle und verankern Sie sie nötigenfalls. **ACHTUNG:** Sobald die Bänke verbunden sind, können Sie sie nur noch sehr schwer versetzen.



3. Montieren Sie das Verbindungsstück an der Seite, an der die nächste Bank anschließen soll.

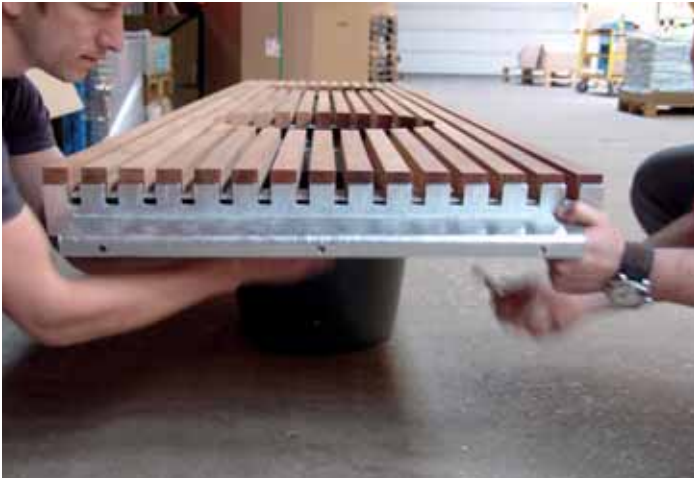

4. Schrauben Sie das Verbindungsstück mit den mitgelieferten Bolzen fest. Achten Sie immer darauf, dass an beiden Seiten eine flache Unterlegscheibe sitzt, und dass die Bolzen noch nicht ganz fest angezogen sind.



5. Stellen Sie jetzt die zweite Bank wie auf den obigen Fotos gezeigt an die erste Bank.



6. Befestigen Sie die zweite Bank mit den Bolzen am Verbindungsstück. Ziehen Sie die Bolzen noch nicht ganz fest an.

PFLEGE

JATOBA

Jatoba benötigen wenig oder gar keine Pflege. Wir empfehlen Ihnen jedoch nachdrücklich, anhaftenden Schmutz zu entfernen. Zur Reinigung des Holzes können Sie Spezialprodukte (www.rmc-extemis.be) oder einfach nur eine harte Bürste und etwas Wasser verwenden. Achten Sie darauf, die Holzfasern nicht irreparabel zu beschädigen. Aus diesem Grund sollten Sie **niemals einen Hochdruckreiniger verwenden**, da dadurch die glatte Oberfläche des Holzes aufgeraut wird und die Holzfasern irreparabel beschädigt werden.

Am Anfang kann das Holz, wenn es mit Wasser in Kontakt kommt, diesen hellroten Farbstoff ausscheiden. Der auf das Gestell und die Unterfläche getropfte Farbstoff ist nach wie vor wasserlöslich und ist nach einiger Zeit völlig verschwunden.

Wir raten unbedingt dazu, das Holz für die Verwendung in Innenräumen zum Schutz vor Flecken einzuölen.

Bei der Lieferung sind die Holzteile unserer Produkte unbehandelt. Wenn sie Sonne und Regen ausgesetzt sind, werden sie mit der Zeit eine silbergraue Farbe annehmen und ihre Oberfläche wird rauer. Wenn Sie ihre ursprüngliche Farbe zu einem gewissen Grad bewahren wollen, sollten Sie sie einmal jährlich ölen. Wir empfehlen die Verwendung von **RMC Hybrid Wood Protector** (www.rmc-extemis.be). RMC-Produkte zur Holzbehandlung sind weltweit erhältlich. Auf der Webseite www.rmc-extemis.com finden Sie einen Händler in Ihrer Nähe

WICHTIG!

Jatobaholz ist ein lebendes Material, das sich trotz seiner vorzüglichen Eigenschaften ständig an extreme Temperatur- und Feuchtigkeitsschwankungen anzupassen hat, was für Spannungen im Holz sorgt. Aufgrund dieser Spannungen fängt das Holz zu „arbeiten“ an, was zu Rissen sowie Farb- und Strukturunterschieden führt. Diese Eigenschaften sind charakteristisch für das Material.

Wenn Sie sich für diese Holzart entscheiden, müssen Sie diese Eigenschaften einfach in Kauf nehmen.

Eventuelle Risse können Sie einfach mit der Hand und einem Blatt Schleifpapier oder mit einer Handschleifmaschine abschleifen. Um verzinkte und gestrichene Teile zu schützen, decken Sie die Kanten mit sehr robustem Abdeckband. Verwenden Sie Schleifpapier mit 80er Körnung und beginnen Sie an der senkrechten Seite der Tischplatte. Halten Sie die Maschine plan an den Tischrand. Leicht anschleifen, bis der Rand wieder gleichmäßig glatt ist. Danach die Oberseite der Tischplatte schleifen. Achten Sie darauf, dass Sie die Maschine plan auf die Tischplatte aufsetzen. Schleifen Sie nicht nur die gerissene Stelle, sondern die gesamte Platte, um ein gleichmäßiges Ergebnis zu erzielen. Um Grate zu vermeiden, schleifen Sie den oberen Rand der Tischplatte glatt. Schleifen Sie diesen Teil mit der Hand. Wenn alle Grate entfernt sind, können Sie den Tisch je nach gewünschtem Effekt mit Hartholzöl einölen.

VERZINKTE METALL

Feuerverzinkung ist die dauerhafteste Art und Weise um Metall vor Rost zu schützen. Wenn die Zinkschicht aber beschädigt ist, kann das freigelegte Metall dennoch anrosten. Mit Zinkfarbe lässt sich diese Beschädigung leicht beheben. Der Unterschied ist nicht merkbar, da die Zinkfarbe und das verzinkte Bein dieselbe Farbe haben. Zudem ist diese Farbe im Handel frei erhältlich.

Galvanisation ist ein thermischer Prozess, der das Material leicht verformen kann. Andere Metallschutzmethoden weisen diesen Nachteil nicht auf, sie sind aber mangelhafter Qualität.

POLYESTER

Polyester mit einem weichen Tuch und Standardreinigungsmitteln wie Sie sie normalerweise in der Küche verwenden, reinigen. Vermeiden Sie auf jeden Fall den Gebrauch aggressiver Reinigungsmittel und Topfkratzer, da Polyester kratzerempfindlich ist.

Auf keinen Fall einen Hochdruckreiniger verwenden!

WWW.EXTREMIS.BE

LANGUAGES

ENGLISH

P. 3

contents	p. 3
assembly romeo & juliet	p. 4
assembly connection piece	p. 6
maintenance	p. 8

NEDERLANDS

P. 11

inhoud	p. 11
montage romeo & juliet	p. 12
montage koppelstuk	p. 14
onderhoud	p. 16

DEUTSCH

P. 19

inhalt	p. 19
montage romeo & juliet	p. 20
montage Anschluss	p. 22
pflege	p. 24

FRANÇAIS

P. 27

contenu	p. 27
montage romeo & juliet	p. 28
montage pièce de connexion	p. 30
entretien	p. 32

ITALIANO

P. 35

contenuto	p. 35
montaggio romeo & juliet	p. 36
montaggio elemento di raccordo	p. 38
manutenzione	p. 40

ESPAÑOL

P. 43

contenido	p. 43
montage romeo & juliet	p. 44
montage pieza conectora	p. 46
mantenimiento	p. 48

CONTENU

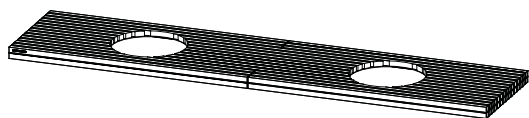

1 x banc en bois

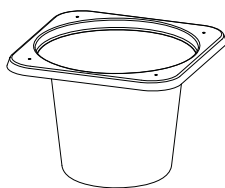

2 x pots extérieurs en polyester

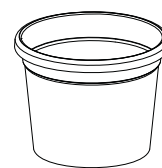

2 x pots intérieurs

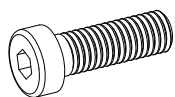

8 x boulon M8x25



8 x rondelle plate M8

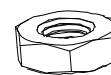

8 x écrou M8

OPTION

PIÈCE DE CONNEXION

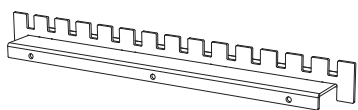

1 x pièce de connexion

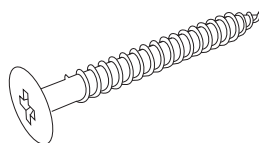

26 x vis 5x30

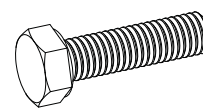

6 x boulon M8x30



6 x écrou M8



12 x rondelle plate M8

MONTAGE ROMEO & JULIET

OUTILS



2 personnes



clé plate n° 13



clé Allen n° 5



+/- 30 min.

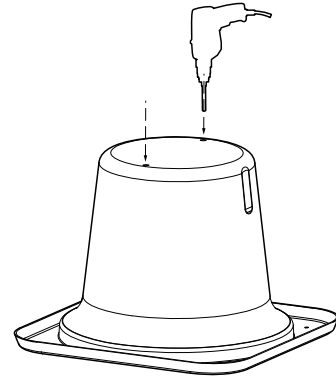

1. Si le banc doit être fixé au sol, forez dans chaque pot en polyester 2 trous aux endroits indiqués.

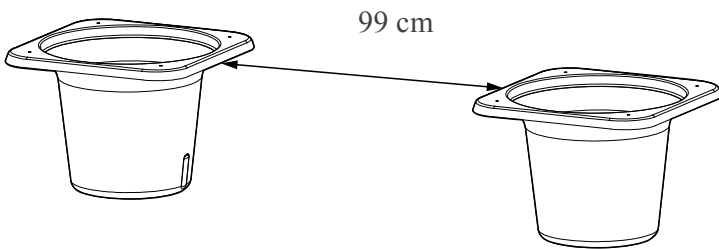

2. Posez à présent les 2 pots en polyester à l'endroit souhaité, à 99 cm l'un de l'autre. En cas de fixation au sol, attendez l'étape suivante pour faire les trous dans le sol.

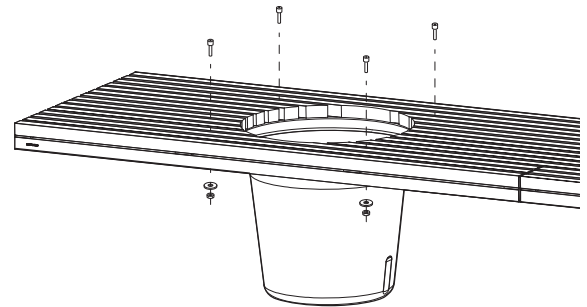

3. Posez la structure du banc en bois sur les 2 pots en polyester et solidarisez l'ensemble au moyen des boulons M8, des rondelles plates et des écrous. Percez éventuellement maintenant les trous pour la fixation au sol.

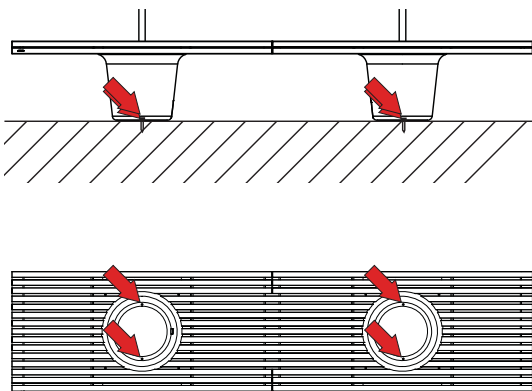

Il faudra prévoir vous-même les boulons ou vis appropriés en fonction du type de sol. Si vous utilisez les pots extérieurs en polyester comme réservoirs d'eau, utilisez 4 vis de bardage, de manière à ce que les trous soient obturés de manière étanche.

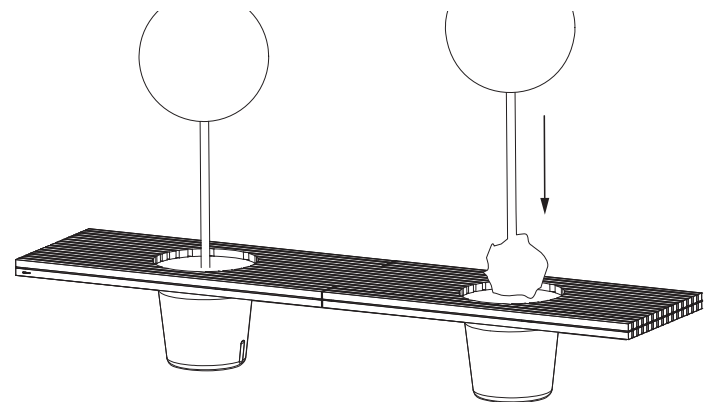

4. Plantez à présent les arbustes dans les pots en polyester (ou dans les pots intérieurs en option). Si vous le souhaitez, vous pouvez recouvrir la terre d'écorces.

ATTENTION!

Les arbustes peuvent être plantés soit directement dans les pots extérieurs en polyester soit dans les pots intérieurs en option. Dans le deuxième cas, les pots extérieurs peuvent servir de réservoirs d'eau. Cela dépendra également des plantes choisies. **Demandez conseil à votre fleuriste.**

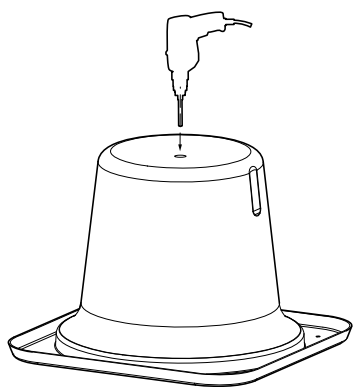

Option A:
directement dans le pot en polyester: veillez à ce que l'eau excédentaire puisse s'écouler, en perçant des trous dans le fond du pot.

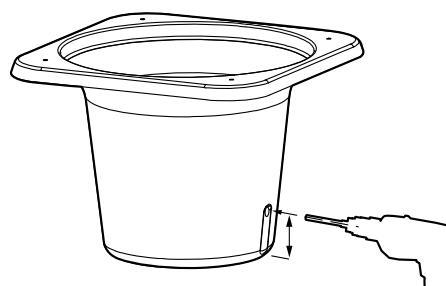

Option B:
dans le pot intérieur, avec réservoir d'eau: veillez à percer un trop-plein à 9 cm du fond du pot.

CONNEXION OPTIONELLE DE # ROMEO & JULIETS

OUTILS

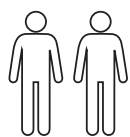

2 personnes



2 x clé plate n° 13



Torx Tx25 tournevis



+/- 30 min.



1. Si nécessaire, ôtez pour commencer les petits blocs en bois du côté où sera fixé le banc suivant. Pour cela, retournez le banc. Ôtez les vis qui fixent les petits blocs et retirez ces blocs. Enfoncez à présent des vis courtes 5*30 dans les orifices libérés, de manière à refixer le profil métallique en L aux longues lattes. Remettez ensuite le banc à l'endroit. Répétez la même opération pour tous les bancs à relier.



2. Installez le premier banc à l'endroit souhaité et fixez-le si nécessaire au sol. **ATTENTION**, une fois que les bancs sont reliés entre eux, ils ne pourront que difficilement être déplacés.



3. Installez l'élément de connexion du côté où vous voulez relier le banc suivant.

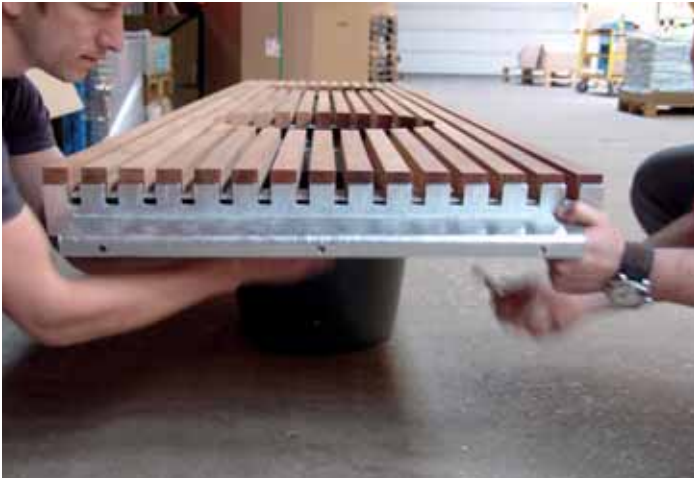

4. Fixez l'élément de connexion avec les boulons fournis. Veillez à ce qu'il y ait toujours une rondelle plate de chaque côté, et ne serrez pas encore complètement les boulons.



5. Placez ensuite le 2ème banc contre le 1er banc, comme le montrent les photos ci-dessus.



6. Fixez le 2ème banc à l'élément de connexion au moyen des boulons. Ne serrez pas encore complètement les boulons.

ENTRETIEN

JATOBA

Les bois Jatoba ne demandent que peu ou pas d'entretien, mais nous recommandons néanmoins fortement d'enlever la saleté persistante. Pour nettoyer le bois, vous pouvez utiliser des produits spéciaux (www.rmc-extremis.be) ou tout simplement une brosse à poils durs et un peu d'eau. Soyez attentif à ne pas endommager les fibres du bois. **N'utilisez dès lors jamais de nettoyeur à haute pression** car cela rendrait la surface lisse du bois rugueuse et endommagerait irrémédiablement les fibres du bois.

Comme beaucoup d'autres essences, le Iroko contient une gomme soluble à l'eau. Au début, le bois sécrètera ce colorant rouge chaque fois qu'il entre en contact avec l'eau. Le colorant ainsi tombé sur le piétement et sur le sol reste soluble à l'eau et disparaîtra complètement après quelque temps.

Il est fortement recommandé de huiler le bois à usage intérieur pour le protéger contre les taches.

À la livraison, les parties en bois de nos produits sont non traitées. L'exposition au soleil et à la pluie modifiera progressivement leur aspect et les rendra grisâtres. Leur surface deviendra aussi plus rugueuse. Si vous souhaitez leur conserver leur couleur d'origine, il faut les huiler une fois par an. Nous recommandons l'utilisation de **RMC Hybrid Wood Protector** (www.rmc-extremis.com). Les produits d'entretien du bois RMC sont disponibles dans le monde entier. Rendez-vous sur le site Web www.rmc-extremis.com pour trouver un revendeur dans vos environs

IMPORTANT !

Le bois est un matériau vivant; bien que Jatoba soit un bois de qualité supérieure, il doit s'adapter à des variations extrêmes de températures et à l'humidité. Cela crée des tensions internes qui font "travailler" le matériau et peuvent causer entre autres des fissures. Des différences de couleur et de structure peuvent aussi apparaître. Ces caractéristiques sont typiques du matériau, et vous les acceptez par votre choix.

Vous pouvez poncer d'éventuelles griffes simplement à la main avec une feuille de papier émeri ou avec une ponceuse manuelle. Protégez les parties galvanisées ou peintes avec du ruban de masquage. Utilisez du papier émeri de grain 80, et commencez sur la face verticale du plateau de table. Tenez la machine parallèlement au bord de la table. Poncez légèrement jusqu'à ce que le bord soit à nouveau parfaitement lisse. Poncez à présent le dessus du plateau. Veillez à tenir la machine bien parallèle au plateau de table. Ne vous limitez pas à la partie griffée mais poncez l'ensemble du plateau afin d'obtenir un résultat égal. Pour éviter les arêtes, lissez l'arête supérieure du plateau. Effectuez cette partie-là à la main. Une fois que toutes les barbes ont été enlevées, vous pouvez, en fonction de l'effet souhaité, huiler la table avec de l'huile pour bois dur.

STRUCTURE GALVANISÉ

La galvanisation ou zingage thermique est la manière la plus durable de protéger le métal contre la formation de rouille. Si la couche de zinc est endommagée, le métal risque de rouiller. C'est facile à traiter; il suffit de passer une peinture au zinc, de la même couleur et disponible dans le commerce.

La galvanisation est un procédé thermique qui peut légèrement déformer le matériau. Les autres techniques de protection du métal n'ont pas cet inconvénient, mais leur qualité est insuffisante.

POLYESTER

nettoyer avec un chiffon doux et un produit de nettoyage que l'on utilise par exemple pour la cuisine. Evitez toujours d'utiliser des produits de nettoyage agressifs ou une éponge à récurer, car le polyester est sensible aux griffes!

N'utilisez en aucun cas un nettoyeur à haute pression!

WWW.EXTREMIS.BE

LANGUAGES

ENGLISH

P. 3

contents	p. 3
assembly romeo & juliet	p. 4
assembly connection piece	p. 6
maintenance	p. 8

NEDERLANDS

P. 11

inhoud	p. 11
montage romeo & juliet	p. 12
montage koppelstuk	p. 14
onderhoud	p. 16

DEUTSCH

P. 19

inhalt	p. 19
montage romeo & juliet	p. 20
montage Anschluss	p. 22
pflege	p. 24

FRANÇAIS

P. 27

contenu	p. 27
montage romeo & juliet	p. 28
montage pièce de connexion	p. 30
entretien	p. 32

ITALIANO

P. 35

contenuto	p. 35
montaggio romeo & juliet	p. 36
montaggio elemento di raccordo	p. 38
manutenzione	p. 40

ESPAÑOL

P. 43

contenido	p. 43
montage romeo & juliet	p. 44
montage pieza conectora	p. 46
mantenimiento	p. 48

CONTENUTO

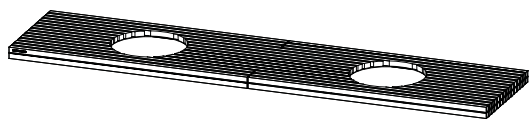

1 x panca di legno

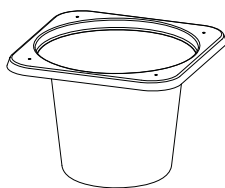

2 x contenitori di poliestere

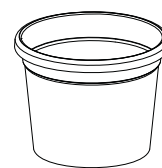

2 x vasi interni

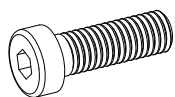

8 x bulloni M8x25



8 x rondelle piane M8



8 x dadi M8

OPZIONALE

ELEMENTO DI RACCORDO

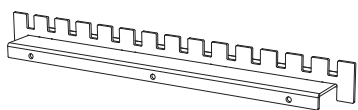

1 x elemento di raccordo

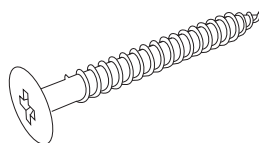

26 x viti 5x30

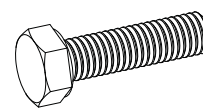

6 x bulloni M8x30



6 x dadi M8



12 x rondelle piane M8

MONTAGGIO ROMEO & JULIET

NECESSARIO PER IL MONTAGGIO

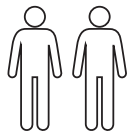

2 persone



chiave inglese nr. 13



chiave a brugola nr. 5



+/- 30 min.

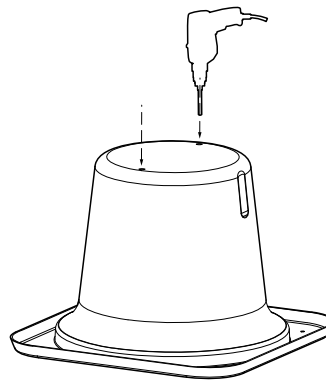

1. Se si deve ancorare la panca al terreno è necessario fare due fori per ogni contenitore di poliestere nei punti indicati.

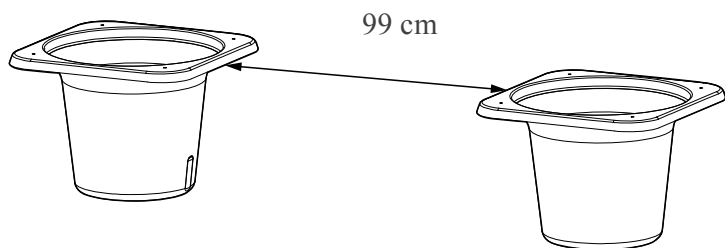

2. Posizionare i due contenitori di poliestere nel punto desiderato a una distanza di 99 cm l'uno dall'altro. In caso di ancoraggio al terreno, aspettare fino al passo successivo per realizzare i fori nel suolo.

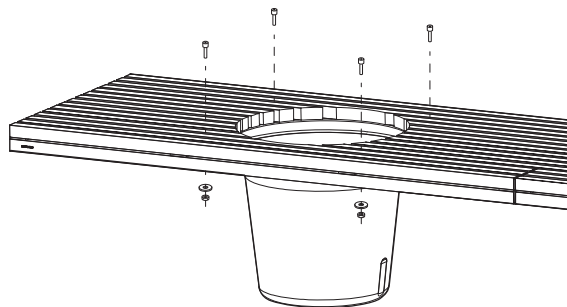

3. Posizionare la panca di legno sui due contenitori in modo da fissarli l'uno all'altro con le viti M8, le rondelle piatte e i dadi. A questo punto praticare i fori per l'ancoraggio al terreno, se previsto.

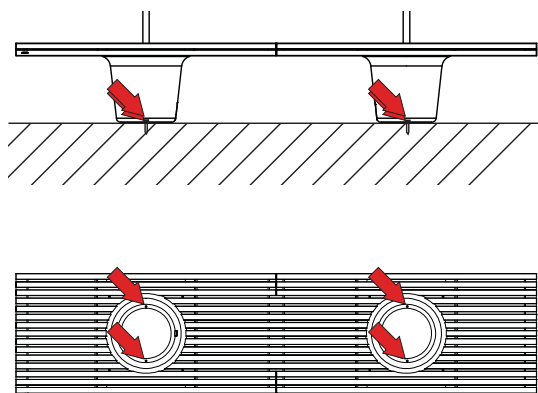

In base al tipo di terreno, è necessario procurarsi bulloni o viti adatti. Se si sceglie l'opzione con serbatoio d'acqua, è necessario utilizzare 4 viti impermeabili in modo che i fori siano chiusi ermeticamente.

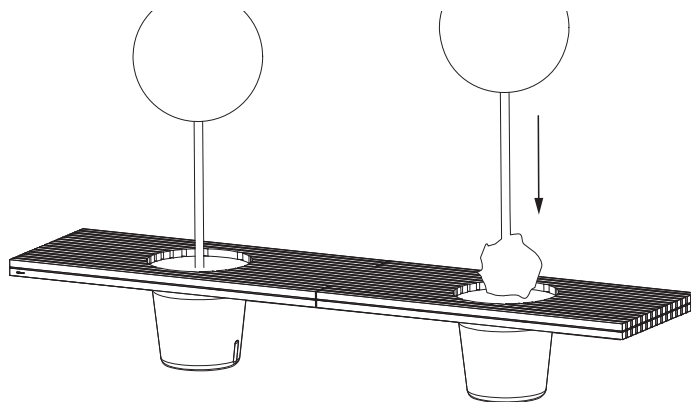

4. Invasare a questo punto le piante nei vasi di poliestere (o nei vasi interni opzionali). Si può eventualmente pacciamare il terriccio con della corteccia.

ATTENZIONE!

Le piante possono essere piantate direttamente nei contenitori di poliestere oppure invasate nei vasi interni opzionali. In quest'ultimo caso viene creato un serbatoio d'acqua. Questo dipende anche dal tipo di pianta scelta. In caso di dubbi, rivolgersi al proprio fioraio.

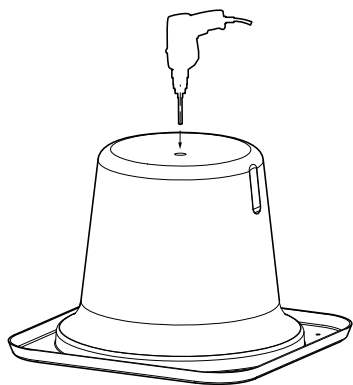

Opzione A:

Direttamente nel contenitore di poliestere: assicurarsi che l'acqua in eccesso possa defluire, praticando dei fori nel lato inferiore del contenitore.

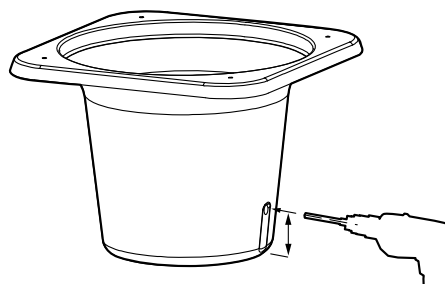

Opzione B:

Nel vaso interno creando un serbatoio d'acqua: in questo caso è necessario praticare un foro di trabocco a 9 cm dal lato inferiore.

RACCORDO OPZIONALE DE # ROMEO & JULIETS

NECESSARIO PER IL MONTAGGIO

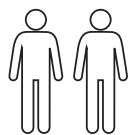

2 persone



2 x chaive inglese nr. 13



Torx Tx25 cacciavite



+/- 30 min.



1. All'occorrenza, i blocchetti di legno sul lato da congiungere devono prima essere rimossi. Per farlo, capovolgere la panca. Rimuovere le viti che fissano i blocchetti e quindi togliere i blocchetti. Avvitare ora viti corte 5*30 nei fori che si sono liberati per fissare nuovamente il profilo in metallo a forma di L ai listelli lunghi. Raddrizzare quindi la panca. Ripetere l'operazione per tutte le panche da unire.



2. Posizionare la prima panca in quello che sarà il suo posto e, se necessario, assicurarla in modo che non si muova. **ATTENZIONE:** una volta che le panche saranno unite, sarà piuttosto difficile spostarle.



3. Montare l'elemento di giunzione sul lato su cui si desidera congiungere la panca successiva.



4. Avvitare l'elemento di giunzione con i bulloni forniti. Assicurarsi di inserire sempre su entrambi i lati una rondella piana e di non avvitare ancora completamente i bulloni.



5. Accostare ora la 2a panca alla 1a come illustrato nelle foto qui sopra.



6. Fissare la 2a panca all'elemento di giunzione servendosi dei bulloni, anche in questo caso senza ancora avvitarli completamente.

MANUTENZIONE

JATOBA

Il legno di Jatoba non richiedono particolare manutenzione. Tuttavia, consigliamo vivamente di rimuovere lo sporco persistente. Per pulire il legno è possibile utilizzare prodotti specifici (www.rmc-extremis.be) o semplicemente una spazzola a setole dure con un po' d'acqua. Fare attenzione a non danneggiare irreparabilmente le fibre del legno. Per evitarlo, **non utilizzare mai un idropulitrice ad alta pressione**, che graffierebbe la superficie liscia del legno danneggiandone irrimediabilmente le fibre.

Come molte altre essenze, la Iroko contiene una gomma idrosolubile. Nel primo tempo dopo l'acquisto questo colorante rosso si libererà ogni volta che la Jatoba entra a contatto con l'acqua. Il colorante sulle gambe e sul suolo resta idrosolubile e sparirà dunque completamente dopo qualche tempo.

Consigliamo vivamente di oliare il legno da utilizzare all'interno per evitare le macchie.

Al momento della consegna, le parti in legno dei nostri prodotti sono non trattate. L'esposizione al sole e alla pioggia ne modificherà gradualmente il colore a un grigio argentato, rendendone inoltre ruvida la superficie. Per preservarne il più possibile il colore originale, le parti andrebbero trattate con olio una volta all'anno. Consigliamo di utilizzare il prodotto **RMC Hybrid Wood Protector** (www.rmc-extremis.com). I prodotti RMC per la cura del legno sono disponibili in tutto il mondo. Per trovare il rivenditore più vicino, visitare il sito web www.rmc-extremis.com

IMPORTANTE!

Il legno è un materiale vivo e, nonostante sia un legno di qualità superiore, all'aperto Jatoba deve costantemente adattarsi alle oscillazioni estreme di temperatura e umidità. A causa delle tensioni interne derivanti da questi adattamenti il legno "si deforma" ed è anche possibile che si creino delle crepe. Possono anche determinarsi variazioni nel colore e nella struttura. Queste caratteristiche sono tipiche del materiale: scegliendolo, accettate anche queste possibili variazioni.

Eventuali graffi possono essere eliminati semplicemente a mano utilizzando della carta vetrata oppure servendosi di una levigatrice manuale. Per proteggere le parti galvanizzate o verniciate, coprirne i bordi con scotch di carta molto resistente. Utilizzare carta vetrata a grana 80 iniziando dal lato verticale del piano del tavolo. Tenere la levigatrice in posizione parallela rispetto al bordo del tavolo. Levigare leggermente finché il bordo è di nuovo liscio e omogeneo. Levigare quindi il ripiano. Fare attenzione a mantenere la levigatrice in posizione parallela rispetto alla superficie del tavolo. Per ottenere un risultato uniforme, non trattare soltanto le parti danneggiate, ma l'intera superficie. Per evitare imperfezioni, levigare il bordo superiore del piano del tavolo a mano. Quando tutte le imperfezioni saranno state rimosse, sarà possibile, a seconda dell'effetto desiderato, trattare il tavolo con olio per legno duro.

STRUTTURA GALVANIZZATA

La galvanizzazione o il rivestimento termico con lo zinco costituiscono il modo più durevole per proteggere il metallo dalla ruggine. Se il rivestimento di zinco è danneggiato, il metallo esposto può arrugginire. Questo fenomeno potrebbe essere facilmente ritoccato con una vernice allo zinco che automaticamente assume lo stesso colore ed è generalmente disponibile nei negozi.

La galvanizzazione è un processo termico che può deformare leggermente il materiale. Altri metodi di protezione del metallo non presentano questo svantaggio, ma la qualità che offrono non è sufficiente.

POLIESTERE

pulire con un panno morbido e un prodotto di pulizia facilmente reperibile che si utilizza anche nella cucina. Evitare in ogni caso l'uso di detersivi aggressivi o di spugnette abrasive, visto che il poliestere è sensibile ai graffi!

Non utilizzare mai una pulitrice alta pressione!

WWW.EXTREMIS.BE

LANGUAGES

ENGLISH

P. 3

contents	p. 3
assembly romeo & juliet	p. 4
assembly connection piece	p. 6
maintenance	p. 8

NEDERLANDS

P. 11

inhoud	p. 11
montage romeo & juliet	p. 12
montage koppelstuk	p. 14
onderhoud	p. 16

DEUTSCH

P. 19

inhalt	p. 19
montage romeo & juliet	p. 20
montage Anschluss	p. 22
pflege	p. 24

FRANÇAIS

P. 27

contenu	p. 27
montage romeo & juliet	p. 28
montage pièce de connexion	p. 30
entretien	p. 32

ITALIANO

P. 35

contenuto	p. 35
montaggio romeo & juliet	p. 36
montaggio elemento di raccordo	p. 38
manutenzione	p. 40

ESPAÑOL

P. 43

contenido	p. 43
montage romeo & juliet	p. 44
montage pieza conectora	p. 46
mantenimiento	p. 48

CONTENIDO

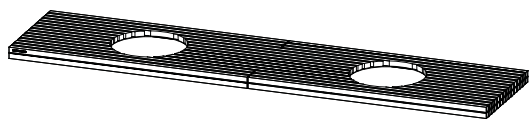

1 x banco de madera

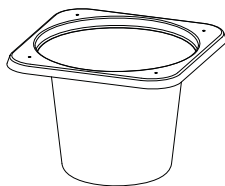

2 x cajones de poliéster

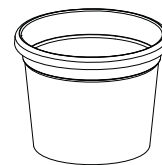

2 x macetas interiores

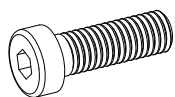

8 x tornillo M8x25



8 x arandela plana M8

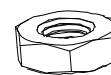

8 x tuerca M8

OPCIONAL

PIEZA CONECTORA

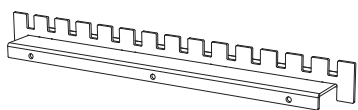

1 x pieza conectora

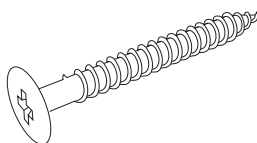

26 x tornillo 5x30

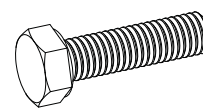

6 x tornillo M8x30



6 x tuerca M8



12 x arandela plana M8

MONTAJE ROMEO & JULIET

UTENSILOS



2 personas



llave fija no. 13



llave macho hexagonal no. 5



+/- 30 min.

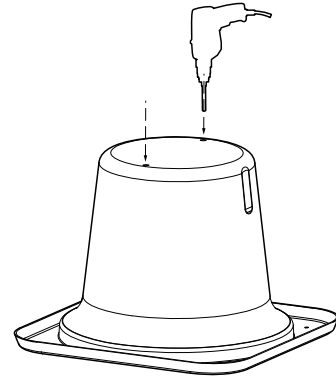

1. Si se debe anclar el banco al suelo, taladre 2 agujeros por cajonera de poliéster, en el lugar indicado.

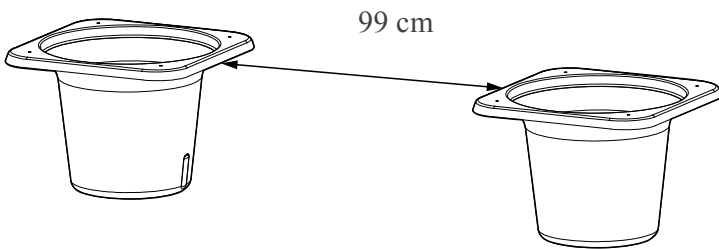

2. Ahora coloque las 2 cajoneras de poliéster en el lugar deseado, con un intervalo de 99 cm. En el caso de un anclaje al suelo, espere hasta el paso siguiente para perforar el suelo.

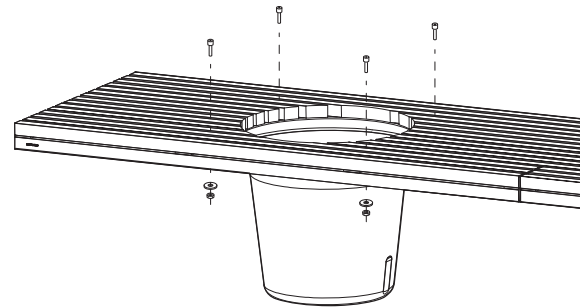

3. Ponga el banco de madera sobre las 2 cajoneras y fíjelo todo con los tornillos M8, arandelas y tuercas. Si hace falta, taladre los agujeros para el anclaje al suelo.

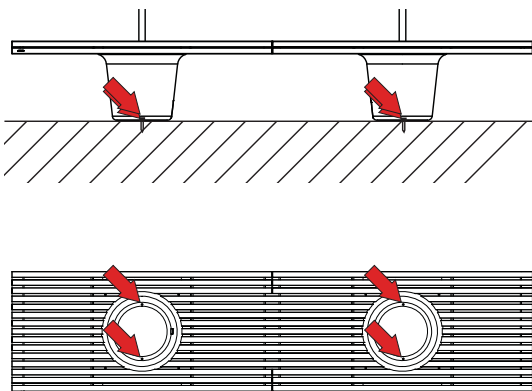

Según el suelo, hace falta procurar tornillos o tuercas por sí mismo. Emplee 4 tornillos de fachada en el caso de una reserva de agua, para impermeabilizar los agujeros.

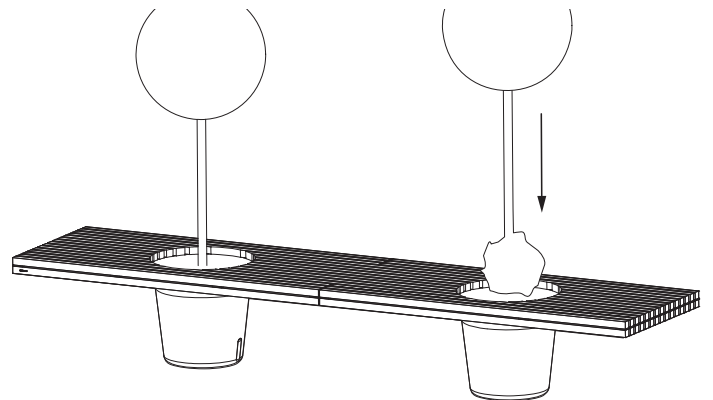

4. Ahora plante los árboles en las macetas de poliéster (or las macetas interiores opcionales). Si así se desea, salpique el suelo con corteza.

CUIDADO!

Los árboles pequeños se plantan directamente en las cajoneras de poliéster, o en la maceta interior opcional, creando una reserva de agua. También depende de las plantas elegidas. **Consulte a su florista.**

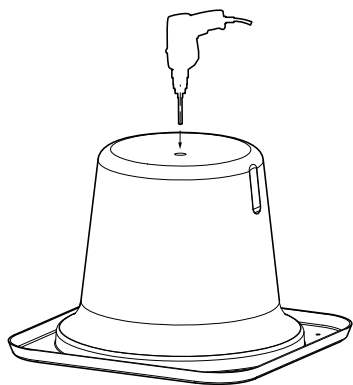

Opción A:
directamente en la cajonera de poliéster: perfore el fondo de la maceta para que el agua superflua pueda evacuarse.

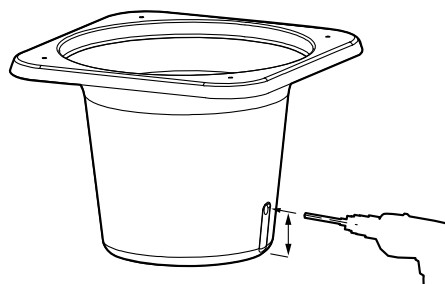

Opción B:
en una maceta interior con reserva de agua: taladre un agujero de desbordamiento a 9 cm del fondo.

CONECTORA OPCIONAL DE # ROMEO & JULIETS

UTENSILOS

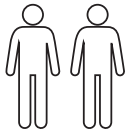

2 personas



2 x llave fija no. 13



Torx Tx25 destornillador



+/- 30 min.



1. Si hace falta, primero quite los bloquecitos de madera en el lado que se acopla. Ponga el banco boca arriba, quite los tornillos que fijan los bloquecitos y quite los bloquecitos mismos. Ahora insiera tornillos cortos 5*30 en los agujeros donde se encontraron los bloquecitos, así que se vuelve a fijar el perfil metálico en forma de L con las tablas largas. Ponga el banco de pie. Hágalo con todos los bancos.



2. Ponga el primer banco en el lugar deseado y anclelo si hace falta. **CUIDADO:** una vez acoplados, es muy difícil mover los bancos.



3. Monte el acoplamiento en el lado en que quiere acoplar otro banco.

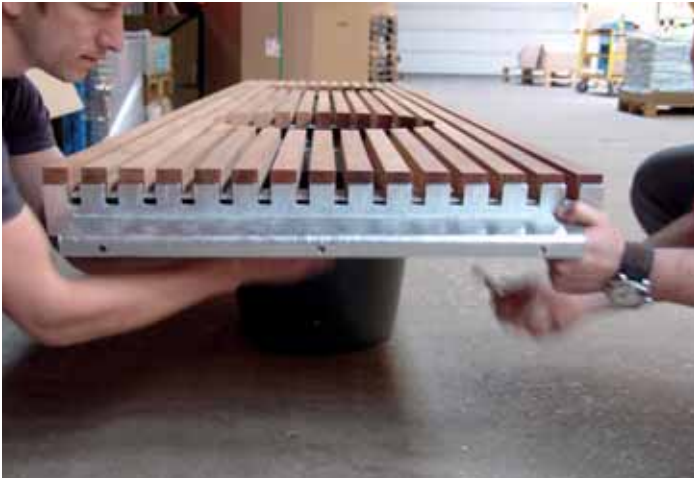

4. Fije el acoplamiento, empleando los pernos suministrados. Procure que siempre hay una arandela plana en ambos lados y que los pernos todavía no están apretados.



5. Ahora coloque el segundo banco contra el primer banco, como se puede ver en las fotos.



6. Fije el segundo banco al acoplamiento, empleando los pernos. No apriete los pernos

MANTENIMIENTO

JATOBA

La madera de Jatoba necesitan poco o ningún mantenimiento. Sin embargo, está fuertemente recomendado eliminar la suciedad persistente. Para limpiar la madera, puede emplear productos especiales (www.rmc-extremis.be) o simplemente un cepillo de cerdas duras y agua. Evite dañar irreparablemente las fibras de la madera. Por eso, **nunca emplee una manguera a presión**; la superficie lisa de la madera se puede volver áspera y puede dañar irreparablemente las fibras de la madera.

Al principio, la madera liberará un tinte rojo cada vez que entre en contacto con agua. El tinte que se pueda filtrar a la estructura o la superficie inferior sigue siendo soluble, por lo que desaparecerá por completo al cabo de cierto tiempo.

Es fuertemente recomendado aceitar la madera para uso interior; así se evitan manchas.

Las partes de madera de nuestros productos se suministran sin tratamiento. Expuestas al sol y a la lluvia, adquirirán una pátina gris plateada. Si quiere mantener más o menos el color original, trátelas con aceite una vez al año. Recomendamos emplear **RMC Hybrid Wood Protector** (www.rmc-extremis.com). Los productos para el tratamiento de madera RMC se venden en el mundo entero. Visite el sitio web www.rmc-extremis.be para buscar un revendedor cerca de usted.

¡¡¡IMPORTANTE!

La madera es un material vivo, por lo que, a pesar de la calidad superior de la Jatoba, se ve afectada por los cambios bruscos de temperatura y por la humedad. Como consecuencia de las tensiones internas provocadas por estas constantes adaptaciones, la madera se alabea. Entre otras cosas, este alabeo puede provocar la aparición de grietas. Asimismo, puede producirse cambios en el color y en la estructura. Dado que estas características son inherentes al material, quien lo elige debe aceptarlas.

Es posible lijar grietas a mano y con papel de lija, o con una lijadora. Para proteger las partes galvanizadas o pintadas, cubra los bordes con cinta de enmascarar muy robusta. Emplee papel de lija de grano 80 y empiece por el lado vertical del tablero. Mantenga la lijadora paralela al borde de la mesa. Lije ligeramente hasta que el borde sea plano. Ahora lije la parte superior. Cuide de mantener la lijadora paralela al tablero. No sólo trate la parte agrietada, pero todo el tablero. Esto asegura que el resultado es llano. Para evitar barbas, lije a mano el borde superior del tablero. Una vez eliminadas las barbas, puede tratar la mesa con aceite para madera dura, en función del efecto deseado.

ACERO GALVANIZADO

La galvanización o el zincado en caliente es la manera más eficaz de evitar la formación de óxido en el metal. Sin embargo, cuando la capa de zinc está dañada, el metal expuesto se oxidará. Este daño es fácilmente remediable mediante la pintura de zinc, de color idéntico y de venta en tiendas.

Es muy excepcional la formación de óxido, pero necesita una reparación a tiempo. La galvanización es un proceso en caliente y puede deformar ligeramente el material. Otros métodos de protección anticorrosiva no presentan esta desventaja, pero proporcionan una calidad insuficiente.

POLIÉSTER

limpiar con un paño suave humedecido con limpiadores estándar de cocina. Evite limpiadores agresivos y estropajos que pudieran rayar la superficie de poliéster!

No utilice nunca una limpiadora alta presión!

WWW.EXTREMIS.BE

{extremis
tools for togetherness

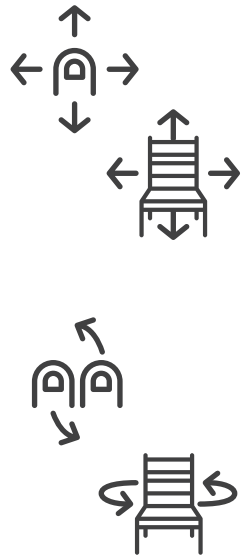

3D PLANNER & CONFIGURATOR

Check out the Extremis app:
Take a picture of your garden
and drag&drop tools for
togetherness in it!

WWW.EXTREMIS.BE

{extremis

tools for togetherness

Extremis NV
Couthoflaan 20b
B - 8972 Poperinge
t +32 57 346020
info@extremis.be
www.extremis.be



for more products go to
WWW.EXTREMIS.BE

All images, ideas, designs and design content are the intellectual property of Extremis and may not be copied, imitated or used, in whole or in part, without the prior written permission of Extremis.