

# FIREFLY®



## GAWANG **FIREFLY** GAWA SA HUSAY



LED  
EYECARE BULB  
EBI508DL



TRI-COLOR INTEGRATED  
DOWNLIGHT  
EDL222206TC



MOTION SENSOR  
LED FLOODLIGHT  
EFL84030DL



SOLAR LED FLOODLIGHT  
FFL51030DL



MINI  
LED STREETLIGHT  
FSL1050DL



SOLAR LED STREETLIGHT  
FSL51120DL

**APRIL 2023**  
**FIREFLY PRICE LIST**

(Prices and specifications are subject to change without prior notice)

**FELCO**  
**FIREFLY ELECTRIC & LIGHTING CORPORATION**

7/F Zen Offices Bldg. 1111 Natividad Lopez St., Ermita, Manila, Philippines

☎ (02) 8789-1000 (Trunkline)

🌐 [www.fireflyelectric.com](http://www.fireflyelectric.com)

✉ [info@fireflyelectric.com](mailto:info@fireflyelectric.com)

📱 @FireflyLightingPH

Contact Person:

# FIREFLY SMART SOLUTIONS

A Touch of Quality Living

Enjoy smart living experience at the palm of your hand.

### HOW IT WORKS

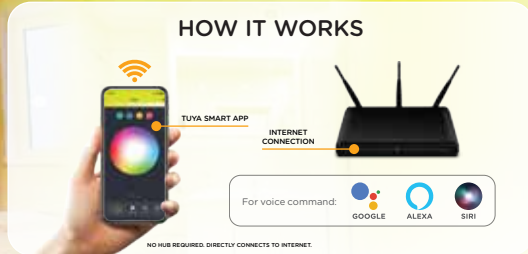

NO HUB REQUIRED. DIRECTLY CONNECTS TO INTERNET.

### HOW TO SET IT UP

Powered by **tuya** Intelligence Inside



**DOWNLOAD**  
TUYA Smart App on your mobile phone via Google Play, Apple Store, QR Code.

**INSTALL**  
Smart product according to the user manual.

**PAIR**  
Smart product via TUYA Smart App or via Google, SIRI or ALEXA.

**CONTROL**  
Your Smart product via TUYA Smart App or via Google, SIRI or ALEXA.

GET IT ON **Google Play** | Download on the **App Store**



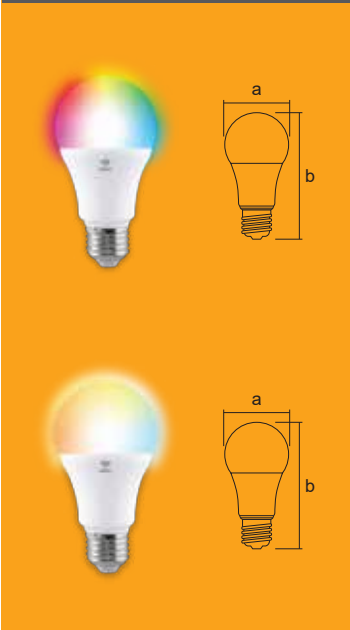







LED BULBS	Wattage	Lumen Output	Color Temperature	Lamp Base	Dimensions	Packaging	Suggested Retail Price
	W	Lm	K		(a x b mm)	Pcs./Ctn.	SRP



**Smart LED Bulb (RGB + CCT + Dimming)**  20,000 H **100-240V Wide Voltage**  **200° Beam Angle**  **≥85 CRI**









FSB109RCD	9	900	RGB* + CCT	E27	60 x 114	60	420.00
FSB115RCD	15	1500	RGB* + CCT	E27	75 x 141.4	60	495.00

\*CCT Changing up to 16 million colors

-  Remote Access
-  Timer Function
-  Activate Via Voice Control
-  Group Control
-  Scenes
-  No Flicker
-  No Photobiological Hazard
-  Dimmable
-  RGB + CCT
-  CERTIFIED Product Safety License No. Q-2287

**Smart LED Bulb (CCT + Dimming)**  20,000 H **100-240V Wide Voltage**  **200° Beam Angle**  **≥85 CRI**

FSB109CD	9	900	3000K - 6500K	E27	60 x 114	60	360.00
FSB115CD	15	1500	3000K - 6500K	E27	75 x 141.4	60	435.00





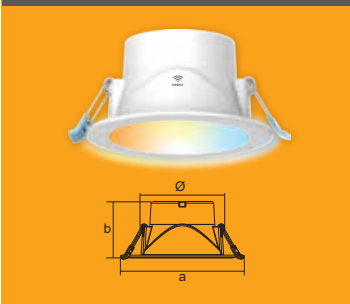



-  Remote Access
-  Timer Function
-  Activate Via Voice Control
-  Group Control
-  Scenes
-  No Flicker
-  No Photobiological Hazard
-  Dimmable
-  CERTIFIED Product Safety License No. Q-2287

LED DOWNLIGHT	Wattage	Lumen Output	Color Temperature	Cut-out Size	Dimensions	Packaging	Suggested Retail Price
	W	Lm	K	(Ømm)	(a x b mm)	Pcs./Ctn.	SRP



**Smart LED Downlight (CCT + Dimming)**  25,000 H **100-240V Wide Voltage**  **100° Beam Angle**  **≥85 CRI**

FSD108CD	8	800	3000K - 6500K	90-110	110 x 90	40	700.00
----------	---	-----	---------------	--------	----------	----	--------





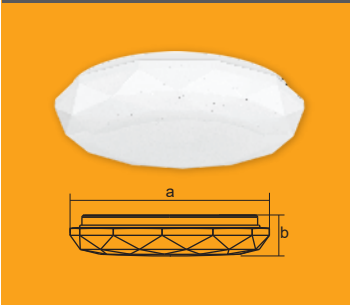



-  Remote Access
-  Timer Function
-  Activate Via Voice Control
-  Group Control
-  Scenes
-  No Flicker
-  No Photobiological Hazard
-  Dimmable

LED CEILING LAMP	Wattage	Lumen Output	Color Temperature	Dimensions	Packaging	Suggested Retail Price
	W	Lm	K	(a x b mm)	Pcs./Ctn.	SRP



**Smart LED Ceiling Lamp (CCT + Dimming)**  25,000 H **100-240V Wide Voltage**  **100° Beam Angle**  **≥85 CRI**

FSD2118CD	18	1800	3000K - 6500K	285 x 60	5	1,850.00
-----------	----	------	---------------	----------	---	----------

-  Remote Access
-  Timer Function
-  Activate Via Voice Control
-  Group Control
-  Scenes
-  No Flicker
-  No Photobiological Hazard
-  Dimmable

SMART SOLUTIONS

LED STRIP LIGHT	Color Temperature	Dimensions	Packaging	Suggested Retail Price
	K	(a x b mm)	Pcs./Ctn.	SRP



### Smart LED Strip Light (RGBW + CCT + Dimming)

20,000 H  
 100° Beam Angle  
 ≥80 CRI

<b>FST101</b>	<b>RGB* + CCT</b>	<b>12 x 3 x 5000</b>	<b>20</b>	<b>1,550.00</b>
Wattage : 11W	Remote Access Timer Function Activate Via Voice Control Linkable* Music Sync Cuttable Scenes No Flicker No Photobiological Hazard Dimmable RGBW + CCT			
Length : 5 Meters				
Input Voltage : 12V				
Lumens / Meter : 160Lm/m				
LED Chips / Meter : 90				

\*Color Changing up to 16 million colors

\*Linkable up to 10 meters only, 22 watts maximum

## SMART CAMERAS



### Smart Pan & Tilt Camera

<b>FSC101</b>	<b>50</b>	<b>1,920.00</b>
Input Voltage : 5V DC/1A	Motion Detection & Notification Motion Tracking IR Night Vision 5m IR Video Quality Remote Viewing 2-Way Communication Viewing Angle Privacy Mode MicroSD Card Slot (Up to 128GB) Device Sharing	
Display Resolution : Up to 1080p		
Audio Input/Output : Built-in Mic and Speaker		
Motion Detection : Up to 5 meters		
Remote Access : P2P		
Application : Indoor use only		

### Smart Adjustable Fixed Camera

<b>FSC201</b>	<b>50</b>	<b>1,725.00</b>
Input Voltage : 5V DC/1A	Motion Detection & Notification IR Night Vision 5m IR Video Quality Remote Viewing 2-Way Communication Viewing Angle Manual Rotation & Tilting Privacy Mode MicroSD Card Slot (Up to 128GB) Device Sharing	
Display Resolution : Up to 1080p		
Audio Input/Output : Built-in Mic and Speaker		
Motion Detection : Up to 5 meters		
Remote Access : P2P		
Application : Indoor use only		

## SMART ACCESSORIES



### Smart Plug

<b>FSP101</b>	<b>200</b>	<b>400.00</b>
Input Voltage : 100-240V 50/60Hz	Remote Access Set ON-OFF Schedule Timer Function Voice Control Overload Protection Device Sharing	
Maximum Current : 10A		
Maximum Load : 2000W		
Wireless Frequency: WiFi 2.4GHz		
WiFi Standard : IEEE 802.11 b/g/n		
Standby Power : <0.5W		

Flat Pin with Ground

SMART SOLUTIONS

# FIREFLY<sup>®</sup>

## COMPLIANT WITH THE PHILIPPINE ENERGY LABELING PROGRAM



Scan to find out more:

# FIREFLY



LED A-BULBS	Wattage	Lumen Output	PELP <sup>1</sup> Star Rating	Color Temperature	Lamp Base	Dimensions	Pkg.	Suggested Retail Price
	W	Lm	1 to 5	K		(a x b mm)	Pcs./Ctn.	SRP



A-Bulbs	30,000 H	100-240V Wide Voltage	200° Beam Angle	≥85 CRI				
FBI206DL	6	600	☆☆☆☆☆	6500 • Daylight	E27	60 x 110	40	165.00
FBI206WW	6	550	☆☆☆☆☆	3000 • Warm White	E27	60 x 110	40	165.00
FBI206CW	6	650	☆☆☆☆☆	4000 • Cool White	E27	60 x 110	40	165.00
FBI210DL	10	1400	☆☆☆☆☆	6500 • Daylight	E27	60 x 120	40	230.00
FBI210WW	10	1250	☆☆☆☆☆	3000 • Warm White	E27	60 x 120	40	230.00
FBI210CW	10	1300	☆☆☆☆☆	4000 • Cool White	E27	60 x 120	40	230.00
FBI214DL	14	1950	☆☆☆☆☆	6500 • Daylight	E27	67 x 145	40	300.00
FBI214WW	14	1800	☆☆☆☆☆	3000 • Warm White	E27	67 x 145	40	300.00
FBI214CW	14	1950	☆☆☆☆☆	4000 • Cool White	E27	67 x 145	40	300.00
FBI218DL	18	2340	☆☆☆☆☆	6500 • Daylight	E27	67 x 147	40	380.00
FBI220DL	20	2600	☆☆☆☆☆	6500 • Daylight	E27	67 x 147	50	400.00

Non-Dimmable

A-Bulb Dimmable	25,000 H	220-240V Operating Voltage	200° Beam Angle	≥80 CRI				
FBI609WW	9	800	Out-of-scope <sup>3</sup>	3000 • Warm White	E27	60 x 110	40	280.00

### FUNCTIONAL LED BULBS



MOTION SENSOR	25,000 H	220-240V Operating Voltage	200° Beam Angle	≥80 CRI				
FBF206DL	6	610	☆☆☆☆☆	6500 • Daylight	E27	60 x 120	50	450.00
FBF206WW	6	600	☆☆☆☆☆	3000 • Warm White	E27	60 x 120	50	450.00

Non-Dimmable  
Uses PIR sensor

MOTION SENSOR	25,000 H	100-240V Wide Voltage	240° Beam Angle	≥80 CRI				
FBF210DL	10	800	☆☆☆☆☆	6500 • Daylight	E27	60 x 120	40	680.00
FBF210WW	10	800	☆☆☆☆☆	3000 • Warm White	E27	60 x 120	40	680.00

Non-Dimmable  
Uses Microwave sensor

DUSK to DAWN	25,000 H	220-240V Operating Voltage	230° Beam Angle	≥80 CRI				
FBF105DL	5	490	☆☆☆☆☆	6500 • Daylight	E27	60 x 110	40	220.00
FBF105WW	5	470	☆☆☆☆☆	3000 • Warm White	E27	60 x 110	40	220.00
FBF109DL	9	860	☆☆☆☆☆	6500 • Daylight	E27	60 x 120	40	250.00
FBF109WW	9	806	☆☆☆☆☆	3000 • Warm White	E27	60 x 120	40	250.00

Non-Dimmable

	25,000 H	220-240V Operating Voltage	240° Beam Angle	≥80 CRI				
FBF110WW	10	800	With COE <sup>2</sup>	3000 • Warm White	E27	60 x 120	40	350.00

Non-Dimmable

Flame lamp	25,000 H	100-277V Wide Voltage	230° Beam Angle	≥80 CRI				
FBF0101R	1		With COE <sup>2</sup>	1500 • Candle Flame	E27	62 x 137	50	450.00

Non-Dimmable

3 Step Dimming	25,000 H	100-240V Wide Voltage	230° Beam Angle	≥80 CRI				
FBF309DL	9 4 1	806	Out-of-scope <sup>3</sup>	6500 • Daylight	E27	60 x 110	40	220.00
FBF311WW	11 5 2	1030	Out-of-scope <sup>3</sup>	3000 • Warm White	E27	60 x 110	40	470.00
FBF312WW*	12 7 2	880 620 250	Out-of-scope <sup>3</sup>	3000 • Warm White	E27	60 x 123	40	470.00

\*220-240V Operating Voltage  
Dimmable. To be used with standard switch only. Not to be used with any dimming devices

FUNCTIONAL LED BULBS	Wattage	Lumen Output	PELP <sup>1</sup> Star Rating	Color Temperature	Lamp Base	Dimensions	Pkg.	Suggested Retail Price
	W	Lm	1 to 5	K		(a x b mm)	Pcs./Ctn.	SRP

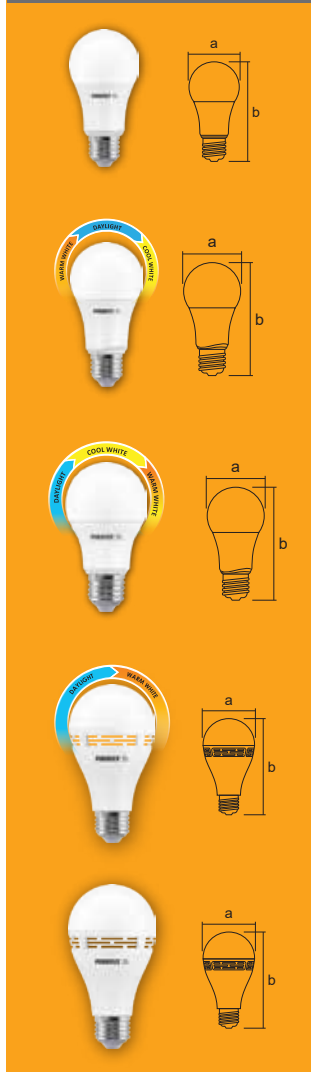

		220-240V Operating Voltage						
FBF409WW	9	850	Out-of-scope <sup>3</sup>	3000 • Warm White	E27	60 x 120	40	<b>420.00</b>

*Dimmable. To be used with standard switch only. Not to be used with any dimming devices*

<b>3-COLOR</b>		100-240V Wide Voltage						
FBF508TC	8	806	Out-of-scope <sup>3</sup>	2700 • Warm White 6500 • Daylight 4000 • Cool White	E27	60 x 120	40	<b>210.00</b>

*Non-Dimmable*

<b>SCENE SWITCH</b>		150-240V Wide Voltage						
FBF509SS	9 3 1	905 380 105	Out-of-scope <sup>3</sup>	6500 • Daylight 4000 • Cool White 3000 • Warm White	E27	60 x 110	40	<b>150.00</b>

*Dimmable. To be used with standard switch only. Not to be used with any dimming devices*

		220-240V Operating Voltage						
FBF606DC	6	470	Out-of-scope <sup>3</sup>	6500 • Daylight 3000 • Warm White	E27	66 x 125	50	<b>1,200.00</b>

*Non-Dimmable*

		100-240V Wide Voltage						
FBF606DL	6	470	With COE <sup>2</sup>	6500 • Daylight	E27	66 x 125	40	<b>850.00</b>
FBF606WW	6	470	With COE <sup>2</sup>	3000 • Warm White	E27	66 x 125	40	<b>850.00</b>

*Non-Dimmable*

### LED NON A-BULBS



		220-240V Operating Voltage						
FBT108DL	8	750	☆☆☆☆☆☆	6500 • Daylight	E27	34 x 140	100	<b>255.00</b>
FBT108WW	8	700	☆☆☆☆☆☆	3000 • Warm White	E27	34 x 140	100	<b>255.00</b>
FBT110DL	10	1050	☆☆☆☆☆☆	6500 • Daylight	E27	34 x 160	100	<b>315.00</b>
FBT110WW	10	1000	☆☆☆☆☆☆	3000 • Warm White	E27	34 x 160	100	<b>315.00</b>

*Non-Dimmable  
To be used with horizontal downlights only.*

<b>Globe</b>		180-264V Wide Voltage						
FBG112WW	12	900	With COE <sup>2</sup>	3000 • Warm White	E27	95 x 127	50	<b>270.00</b>
FBG114WW	14	1200	With COE <sup>2</sup>	3000 • Warm White	E27	95 x 132	50	<b>340.00</b>
FBG116WW	16	1400	With COE <sup>2</sup>	3000 • Warm White	E27	100 x 130	20	<b>420.00</b>

*Non-Dimmable*

<b>Colored PAR38</b>		100-240V Wide Voltage						
FBP914B	14	-	Out-of-scope <sup>3</sup>	• Blue	E27	121 x 136	20	<b>410.00</b>
FBP914Y	14	-	Out-of-scope <sup>3</sup>	• Yellow	E27	121 x 136	20	<b>410.00</b>
FBP914R	14	-	Out-of-scope <sup>3</sup>	• Red	E27	121 x 136	20	<b>410.00</b>
FBP914G	14	-	Out-of-scope <sup>3</sup>	• Green	E27	121 x 136	20	<b>410.00</b>

*Non-Dimmable*

LED TUBES	Wattage	Lumen Output	PELP <sup>1</sup> Star Rating	Color Temperature	Lamp Base	Dimensions	Pkg.	Suggested Retail Price
	W	Lm	1 to 5	K		(a x b mm)	Pcs./Ctn.	SRP

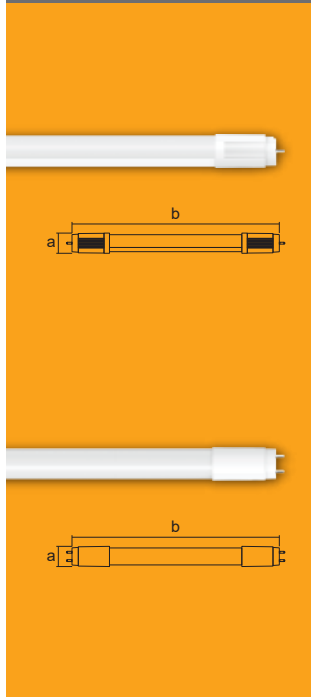

**T8 Tube with LED Starter**

30,000 H | 100-277V Wide Voltage | 200° Beam Angle | 80 CRI

LFS03T8DL09	9	1100	★★★★☆	6500 • Daylight	G13	25.4 x 600	40	350.00
LFS03T8WW09	9	850	With COE <sup>2</sup>	3000 • Warm White	G13	25.4 x 600	40	350.00
LFS03T8CW09	9	850	With COE <sup>2</sup>	4000 • Cool White	G13	25.4 x 600	40	350.00
LFS03T8DL18	18	2200	★★★★☆	6500 • Daylight	G13	25.4 x 1200	20	500.00
LFS03T8WW18	18	1750	With COE <sup>2</sup>	3000 • Warm White	G13	25.4 x 1200	20	500.00
LFS03T8CW18	18	1750	With COE <sup>2</sup>	4000 • Cool White	G13	25.4 x 1200	20	500.00

**T8 Tube with LED Starter**

ENERGY EFFICIENT AT 125 LM/W | 50,000 H | 198-277V Wide Voltage | 200° Beam Angle | ≥90 CRI

F2LST8DL09	9	1125	★★★★☆	6500 • Daylight	G13	28 x 595.7	40	475.00
F2LST8DL18	18	2250	★★★★☆	6500 • Daylight	G13	28 x 1205.3	20	700.00

**T8 Tube with LED Starter**

ENERGY EFFICIENT AT 150 LM/W | 50,000 H | 100-277V Wide Voltage | 180° Beam Angle | ≥83 CRI

FFS02T8DL12	12	1800	★★★★★	6500 • Daylight	G13	28 x 1205.3	20	930.00
FFS02T8CW12**	12	1800	★★★★★	5000 • Cool White	G13	28 x 1205.3	20	930.00

Non-Dimmable  
\*\*Special order only; not in-stock.

LED DOWNLIGHTS	Wattage	Lumen Output	Color Temperature	Dimmable	Dimensions	Cut-out Size	Packaging	Suggested Retail Price
	W	Lm	K	Yes/No	(a x b mm)	mm	Pcs./Ctn.	SRP



**Water Resistant**

30,000 H | 220-240V Operating Voltage | 110° Beam Angle | ≥80 CRI | IP44 IP Rating

FDL2505DL	5	480	6500 • Daylight	no	Ø 120 x 35	Ø 100	20	375.00
FDL2505WW	5	460	3000 • Warm White	no	Ø 120 x 35	Ø 100	20	375.00
FDL2509DL	9	960	6500 • Daylight	no	Ø 170 x 35	Ø 150	20	585.00
FDL2509WW	9	910	3000 • Warm White	no	Ø 170 x 35	Ø 150	20	585.00

**Tiltable**

30,000 H | 220-240V Operating Voltage | 36° Beam Angle | ≥80 CRI

FDL2407WW	7	580	3000 • Warm White	no	60 x Ø 85	Ø 68 - Ø 75	120	470.00
FDL2410WW	10	900	3000 • Warm White	no	71 x Ø 105	Ø 83 - Ø 95	80	590.00

FUNCTIONAL LED CEILING LAMPS	Wattage	Lumen Output	Color Temperature	Dimmable	Dimensions	Packaging	Suggested Retail Price
	W	Lm	K	Yes/No	(a x b mm)	Pcs./Ctn.	SRP



**3-COLOR CEILING LAMP with Remote Control**

25,000 H | 220-240V Operating Voltage | 120° Beam Angle | ≥85 CRI

FCL614RC	14	1260	6500 • Daylight 3000 • Warm White 4000 • Cool White	yes	300 x 65	5	1,300.00
FCL619RC	19	1710	6500 • Daylight 3000 • Warm White 4000 • Cool White	yes	350 x 65	5	1,500.00

Dimmable. To be used with standard switch only. Not to be used with any dimming devices

**Bluetooth SPEAKER 3-COLOR CEILING LAMP**

25,000 H | 100-240V Wide Voltage | 120° Beam Angle | ≥85 CRI

FCL625TC	20	1350 1350 1200	6500 • Daylight 3000 • Warm White 4000 • Cool White	no	356 x 86	5	2,500.00
----------	----	----------------------	---	----	----------	---	----------

FUNCTIONAL LED CEILING LAMPS	Wattage	Lumen Output	Color Temperature	Dimmable	Lamp Base	Dimensions	Packaging	Suggested Retail Price
	W	Lm	K	Yes/No		(a x b mm)	Pcs./Ctn.	SRP

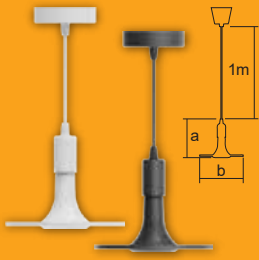

### 3 Step Dimming

Ceiling Lamp with E27 Pendant Socket    25,000 H    110-277V Wide Voltage    360° Beam Angle    ≥80 CRI

FCL238012CW/W (White)	12 9 3	1100	4000 • Cool White	yes	E27	75 x 192	6	900.00
FCL238012WW/B (Black)	12 9 3	1000	3000 • Warm White	yes	E27	75 x 192	6	900.00

*Dimmable. To be used with standard switch only. Not to be used with any dimming devices*

## LED SHOP LIGHTS

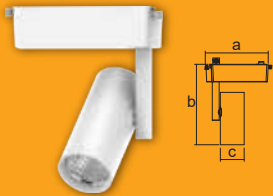

Track Light    30,000 H    100-240V Wide Voltage    24° Beam Angle    90 CRI

FTL1112WW	12	1100	3000 • Warm White	no	-	132 x 169mm x Ø 52	20	1,425.00
FTL1118WW	18	1600	3000 • Warm White	no	-	132 x 190mm x Ø 60	20	1,960.00
FTL1125WW	25	2200	3000 • Warm White	no	-	132 x 190mm x Ø 60	20	2,565.00
FTL1135WW	35	3000	3000 • Warm White	no	-	180 x 233mm x Ø 80	20	2,960.00

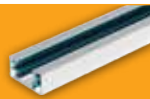

Accessory: Track Bar for LED Track Light  
FTL1000WH  
SRP: 450.00

Color : White  
Material : Aluminum  
Dimensions : 1000 x 34 x 17 mm

## SOLAR LED FLOODLIGHTS

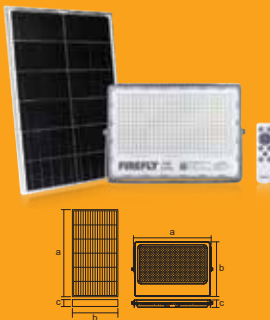

**New!**

**SOLAR Floodlight**

6500 • Daylight Color Temp.

50,000 Hrs. LED Life

12 Hrs. Working Time

5-6 Hrs. Charging Time

**IP65**

IP Rating

FFL51030DL	30	3000	6V 40W	154WH	350 x 285 x 90	670 x 350 x 25	30	6,800.00
FFL51050DL	50	5000	6V 60W	192WH	400 x 315 x 90	670 x 535 x 25	50	9,700.00

## LED FLOODLIGHTS

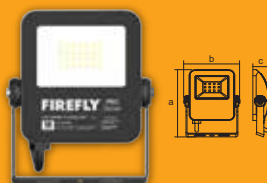

**New!**

Omega Floodlight

30,000 H

220-240V Wide Voltage

110° Beam Angle

≥85 CRI

**IP65**

IP Rating

FFL3010DL*	10	1200	6000 • Daylight	no	118 x 110 x 31	10	620.00
FFL3020DL*	20	2400	6000 • Daylight	no	134 x 117 x 33	10	750.00
FFL3030DL*	30	3600	6000 • Daylight	no	149 x 134 x 34	10	1,200.00
FFL3050DL*	50	6000	6000 • Daylight	no	186 x 174 x 44	10	1,700.00
FFL3100DL	100	11000	6000 • Daylight	no	248 x 229 x 48	5	4,300.00

\*DOB (Driver on Board) is around 35% lighter than a traditional floodlight



LED FLOODLIGHTS	Wattage	Lumen Output	Color Temperature	Dimmable	Dimensions	Packaging	Suggested Retail Price
	W	Lm	K	Yes/No	(a x b x c mm)	Pcs./Ctn.	SRP



Floodlight Gen 2	30,000 H	90-265V Wide Voltage	110° Beam Angle	≥80 CRI	IP65 IP Rating		
FFL2010DL/W	10	1050	6000 • Daylight	no	136 x 122 x 36	20	825.00
FFL2010DL	10	1050	6000 • Daylight	no	136 x 122 x 36	20	825.00
FFL2010WW	10	1000	3000 • Warm White	no	136 x 122 x 36	20	825.00
FFL2020DL	20	2100	6000 • Daylight	no	136 x 122 x 36	20	990.00
FFL2020WW	20	2000	3000 • Warm White	no	136 x 122 x 36	20	990.00
FFL2030DL/W	30	3150	6000 • Daylight	no	180 x 155 x 47	12	1,980.00
FFL2030DL	30	3150	6000 • Daylight	no	180 x 155 x 47	12	1,980.00
FFL2030WW	30	3000	3000 • Warm White	no	180 x 155 x 47	12	1,980.00
FFL2050DL/W	50	5250	6000 • Daylight	no	230 x 207 x 43	12	2,475.00
FFL2050DL	50	5250	6000 • Daylight	no	230 x 207 x 43	12	2,475.00
FFL2050WW	50	5000	3000 • Warm White	no	230 x 207 x 43	12	2,475.00
FFL2100DL	100	11000	6000 • Daylight	no	264 x 252 x 55	4	5,445.00
FFL2200DL	200	22000	6000 • Daylight	no	391 x 358 x 62	1	10,120.00

Floodlight	30,000 H	90-265V Wide Voltage	110° Beam Angle	≥80 CRI	IP65 IP Rating		
FFL1010DL/G	10	950	6000 • Daylight	no	95 x 140	20	700.00
FFL1010WW/G	10	850	3000 • Warm White	no	95 x 140	20	700.00
FFL1020DL/G	20	1900	6000 • Daylight	no	95 x 140	20	900.00
FFL1020WW/G	20	1700	3000 • Warm White	no	95 x 140	20	900.00
FFL1030DL/G	30	2850	6000 • Daylight	no	165 x 243	12	1,800.00
FFL1030WW/G	30	2550	3000 • Warm White	no	165 x 243	12	1,800.00
FFL1050DL/G	50	4750	6000 • Daylight	no	165 x 243	12	2,250.00
FFL1050WW/G	50	4250	3000 • Warm White	no	165 x 243	12	2,250.00
FFL1070DL/G	70	6650	6000 • Daylight	no	195 x 286	4	4,400.00
FFL1070WW/G	70	5950	3000 • Warm White	no	195 x 286	4	4,400.00
FFL1100DL/G	100	9500	6000 • Daylight	no	195 x 286	4	4,950.00
FFL1150DL/G	150	14250	6000 • Daylight	no	330 x 420	1	9,000.00
FFL1200DL/G	200	19000	6000 • Daylight	no	330 x 420	1	10,000.00

SOLAR LED STREETLIGHTS	Wattage	Lumen Output	Solar Panel	Battery Type	Dimensions	Packaging	Suggested Retail Price
	W	Lm	Polycrystalline	LiFePO4	(a x b x c mm)	Pcs./Ctn.	SRP

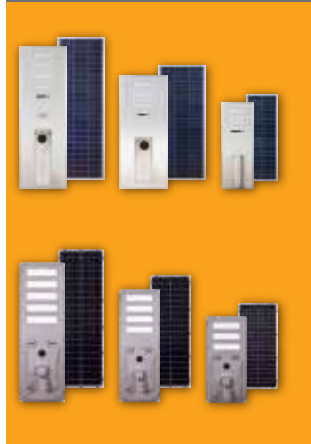

PRO1 SOLAR Streetlight	6500 • Daylight Color Temp.	50,000 Hrs. LED Life	12 Hrs. Working Time	4-5 Hrs. Charging Time	IP66 IP Rating		
FSL51060DL	60	9600	18V 65W	372WH	1000 x 360 x 125	1	19,320.00
FSL51120DL	120	19200	36V 120W	864WH	1310 x 530 x 270	1	30,340.00
FSL51150DL	150	24000	36V 150W	1200WH	1640 x 530 x 330	1	38,990.00

PRO2 SOLAR Streetlight	6500 • Daylight Color Temp.	50,000 Hrs. LED Life	12 Hrs. Working Time	4-5 Hrs. Charging Time	IP66 IP Rating		
FSL52030DL	30	3300	6V 60W	144WH	887 x 400 x 25	1	22,000.00
FSL52060DL	60	9600	6V 80W	288WH	1160 x 400 x 25	1	28,000.00
FSL52090DL	90	12000	6V 100W	384WH	1435 x 400 x 25	1	35,000.00

LED STREETLIGHTS	Wattage	Lumen Output	Color Temperature	Dimmable	Dimensions	Packaging	Suggested Retail Price
	W	Lm	K	Yes/No	(a x b x c mm)	Pcs./Ctn.	SRP

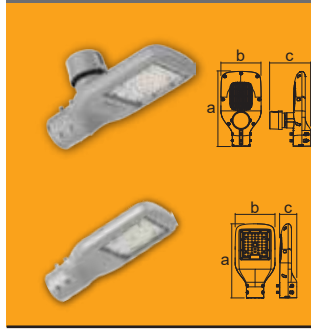

Mini Streetlight with Rotatable Photocell	50,000 H	100-277V Wide Voltage	150x95° Beam Angle	≥80 CRI	IP65 IP Rating		
FSL1030DL/S	30	3600	6500 • Daylight	no	335 x 180 x 180	6	4,600.00
FSL1050DL/S	50	5000	6500 • Daylight	no	335 x 180 x 180	6	5,200.00
Mini Streetlight							
FSL1030DL	30	3600	6500 • Daylight	no	335 x 180 x 78	6	3,200.00
FSL1050DL	50	5000	6500 • Daylight	no	335 x 180 x 78	6	3,800.00

LED STREETLIGHTS	Wattage	Lumen Output	Color Temperature	Dimmable	Dimensions	Packaging	Suggested Retail Price
	W	Lm	K	Yes/No	(a x b x c mm)	Pcs./Ctn.	SRP

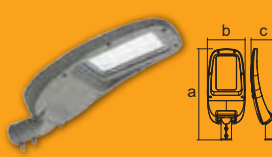



**Streetlight**

50,000 H

90-305V  
Wide Voltage



145°  
Beam Angle

IP65  
IP Rating

FSL2060DL	60	7800	5700 • Daylight	no	520 x 212 x 90	1	7,500.00
FSL2080DL	80	10400	5700 • Daylight	no	616 x 259 x 186	1	9,000.00
FSL2100DL	100	13000	5700 • Daylight	no	616 x 259 x 186	1	10,500.00
FSL2120DL**	120	15600	5700 • Daylight	no	677 x 303 x 186	1	11,500.00
FSL2150DL**	150	19500	5700 • Daylight	no	677 x 303 x 186	1	12,500.00
FSL2200DL**	200	26000	5700 • Daylight	no	850 x 366 x 198	1	17,500.00

\*\*Special orders only ; not in-stock.

### LED CANOPY LIGHTS

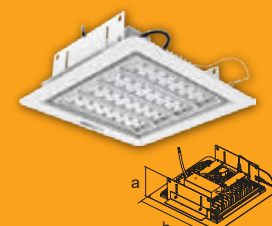



**Canopy Light**

50,000 H

100-277V  
Wide Voltage



130°  
Beam Angle

≥80  
CRI

IP65  
IP Rating

FCL1120DL	120	12000	6000 • Daylight	no	140 x 410	1	14,650.00
-----------	-----	-------	-----------------	----	-----------	---	-----------

LED INDUSTRIAL LIGHTS	Wattage	Lumen Output	Color Temperature	Dimmable	Lamp Base	Dimensions	Packaging	Suggested Retail Price
	W	Lm	K	Yes/No		(a x b x c mm)	Pcs./Ctn.	SRP





**High Power LED Lamp**

30,000 H

220V  
Operating Voltage





120°  
Beam Angle

80  
CRI

FHC1040DL	40	3800	6500 • Daylight	no	E27	145 x 220	6	1,020.00
FHC1060DL	60	5700	6500 • Daylight	no	E27	170 x 230	6	1,495.00
FHC1080DL	80	7600	6500 • Daylight	no	E40	190 x 275	4	1,930.00
FHC1100DL	100	9500	6500 • Daylight	no	E40	190 x 275	4	2,670.00

	<b>Accessory: Reflector for FHC1040DL</b> FHC1040-R <b>SRP: 215.00</b>	<b>Reflector for FHC1060DL</b> FHC1060-R <b>SRP: 340.00</b>
---	--	---





**UFO High Bay**

30,000 H

110-240V  
Wide Voltage



90°  
Beam Angle

>85  
CRI

FHB88080DL	80	7200	6500 • Daylight	no	E40	∅280 x 205	6	1,965.00
FHB88100DL	100	10300	6500 • Daylight	no	E40	∅280 x 205	6	2,270.00
FHB88120DL	120	12600	6500 • Daylight	no	E40	∅345 x 215	2	3,600.00
FHB88150DL	150	15000	6500 • Daylight	no	E40	∅345 x 215	2	3,850.00

**New!**



**High Bay with Motion Sensor**

50,000 H

100-277V  
Wide Voltage





110°  
Beam Angle

≥80  
CRI

IP65  
IP Rating

FHB85100DL	100	12500	6500 • Daylight	no	N/A	∅270 x 160	1	6,250.00
FHB85150DL	150	18750	6500 • Daylight	no	N/A	∅310 x 160	1	7,450.00

	<b>Remote Control (for LE High Bay with Motion Sensor)</b> FHB85RC <b>SRP: 950.00</b>
---	---





**High Bay**

50,000 H

100-240V  
Wide Voltage



110°  
Beam Angle

80  
CRI

IP65  
IP Rating

FHB5100DL	100	13000	5700 • Daylight	no	N/A	∅ 220 x 171	1	6,710.00
FHB5150DL	150	19500	5700 • Daylight	no	N/A	∅ 330 x 171	1	9,020.00
FHB5200DL	200	26000	5700 • Daylight	no	N/A	∅ 330 x 171	1	10,120.00

	<b>Accessory: Reflector for FHB5100DL</b> FHB5100-R <b>SRP: 990.00</b>	<b>Accessory: Reflector for FHB5150DL &amp; FHB5200DL</b> FHB5150-R <b>SRP: 1190.00</b>
---	--	---





**High Bay**

50,000 H

90-305V  
Wide Voltage



90°  
Beam Angle

90  
CRI

IP65  
IP Rating

FHB4130DL	130	13000	5000 • Daylight	no	N/A	279 x 187	1	12,775.00
-----------	-----	-------	-----------------	----	-----	-----------	---	-----------

LED A-BULBS	Wattage	Lumen Output	PELP <sup>1</sup> Star Rating	Color Temperature	Lamp Base	Dimensions	Pkg.	Suggested Retail Price
	W	Lm	1 to 5	K		(a x b mm)	Pcs./Ctn.	SRP



A-Bulb Singles	20,000 H	100-240V Wide Voltage	200° Beam Angle	≥85 CRI				
EBI103DL	3	345	★★★★☆	6500 • Daylight	E27	45 x 75	50	70.00
EBI103WW	3	315	★★★★☆	3000 • Warm White	E27	45 x 75	50	70.00
EBI103CW	3	330	★★★★☆	4000 • Cool White	E27	45 x 75	50	70.00
EBI105DL	5	575	★★★★☆	6500 • Daylight	E27	60 x 110	50	80.00
EBI105WW	5	530	★★★★☆	3000 • Warm White	E27	60 x 110	50	80.00
EBI105CW	5	550	★★★★☆	4000 • Cool White	E27	60 x 110	50	80.00
EBI107DL	7	805	★★★★☆	6500 • Daylight	E27	60 x 110	50	95.00
EBI107WW	7	735	★★★★☆	3000 • Warm White	E27	60 x 110	50	95.00
EBI107CW	7	770	★★★★☆	4000 • Cool White	E27	60 x 110	50	95.00
EBI109DL	9	1035	★★★★☆	6500 • Daylight	E27	60 x 110	50	105.00
EBI109WW	9	945	★★★★☆	3000 • Warm White	E27	60 x 110	50	105.00
EBI109CW	9	990	★★★★☆	4000 • Cool White	E27	60 x 110	50	105.00
EBI111DL	11	1265	★★★★☆	6500 • Daylight	E27	60 x 117	50	120.00
EBI111WW	11	1145	★★★★☆	3000 • Warm White	E27	60 x 117	50	120.00
EBI113DL*	13	1495	★★★★☆	6500 • Daylight	E27	60 x 122	50	145.00
EBI115DL*	15	1695	★★★★☆	6500 • Daylight	E27	67 x 143	50	165.00
EBI118DL**	18	2070	★★★★☆	6500 • Daylight	E27	67 x 143	50	240.00
EBI120DL**	20	2300	★★★★☆	6500 • Daylight	E27	67 x 143	50	260.00

Non-Dimmable  
 \* 130-240V Wide Voltage  
 \*\* 170-240V Wide Voltage



A-Bulb Singles	20,000 H	220-240V Operating Voltage	230° Beam Angle	≥80 CRI				
EBI125DL	25	2800	★★★☆☆	6500 • Daylight	E27	95 x 186	20	300.00
EBI130DL	30	3600	With COE <sup>2</sup>	6500 • Daylight	E27	110 x 210	12	370.00
EBI135DL	35	4200	With COE <sup>2</sup>	6500 • Daylight	E27	120 x 232	12	430.00

Non-Dimmable



A-Bulb 3-Bulb Value Pack	20,000 H	100-240V Wide Voltage	200° Beam Angle	≥80 CRI				
V30EBI103DL	3	345	★★★★☆	6500 • Daylight	E27	N/A	40 sets	200.00
V30EBI105DL	5	575	★★★★☆	6500 • Daylight	E27	N/A	20 sets	230.00
V30EBI107DL	7	805	★★★★☆	6500 • Daylight	E27	N/A	20 sets	275.00
V30EBI109DL	9	1035	★★★★☆	6500 • Daylight	E27	N/A	20 sets	300.00
V30EBI111DL	11	1265	★★★★☆	6500 • Daylight	E27	N/A	20 sets	345.00
V30EBI113DL	13	1495	★★★★☆	6500 • Daylight	E27	N/A	20 sets	415.00
V30EBI115DL	15	1695	★★★★☆	6500 • Daylight	E27	N/A	20 sets	475.00

Non-Dimmable



A-Bulb 4-Bulb Value Pack	20,000 H	100-240V Wide Voltage	200° Beam Angle	≥80 CRI				
V40EBI103DL	3	345	★★★★☆	6500 • Daylight	E27	N/A	24 sets	265.00
V40EBI105DL	5	575	★★★★☆	6500 • Daylight	E27	N/A	24 sets	305.00
V40EBI107DL	7	805	★★★★☆	6500 • Daylight	E27	N/A	24 sets	365.00
V40EBI109DL	9	1035	★★★★☆	6500 • Daylight	E27	N/A	24 sets	395.00
V40EBI111DL	11	1265	★★★★☆	6500 • Daylight	E27	N/A	24 sets	455.00
V40EBI113DL	13	1495	★★★★☆	6500 • Daylight	E27	N/A	24 sets	550.00
V40EBI115DL	15	1695	★★★★☆	6500 • Daylight	E27	N/A	24 sets	630.00

Non-Dimmable



EYEcare	20,000 H	110-240V Wide Voltage	200° Beam Angle	≥90 CRI				
EBI504DL	4	460	★★★★☆	6500 • Daylight	E27	60 x 113	50	75.00
EBI506DL	6	710	★★★★☆	6500 • Daylight	E27	60 x 113	50	85.00
EBI508DL	8	944	★★★★☆	6500 • Daylight	E27	60 x 116	50	100.00
EBI510DL	10	1180	★★★★☆	6500 • Daylight	E27	60 x 116	50	115.00
EBI512DL	12	1420	★★★★☆	6500 • Daylight	E27	60 x 116	50	130.00
EBI514DL	14	1620	★★★★☆	6500 • Daylight	E27	60 x 116	50	155.00
EBI516DL	16	1860	★★★★☆	6500 • Daylight	E27	60 x 116	50	175.00

Non-Dimmable

FUNCTIONAL LED LAMPS	Wattage	Lumen Output	PELP <sup>1</sup> Star Rating	Color Temperature	Lamp Base	Dimensions	Pkg.	Suggested Retail Price
	W	Lm	1 to 5	K		(a x b mm)	Pcs./Ctn.	SRP

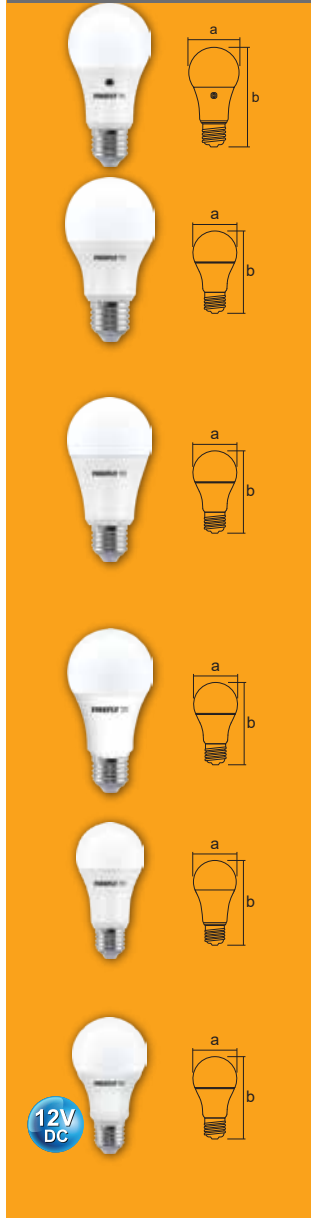

**New!** **DUSK to DAWN** 20,000 H 220-240V Operating Voltage 200° Beam Angle ≥85 CRI

EBF8305DL	5	525	☆☆☆☆☆	6500 • Daylight	E27	60 x 110	40	200.00
EBF8308DL	8	840	☆☆☆☆☆	6500 • Daylight	E27	60 x 120	40	220.00

Non-Dimmable

**New!** **3-COLOR** 20,000 H 100-240V Operating Voltage 200° Beam Angle ≥85 CRI

EBF8608TC	8	900	Out-of-scope <sup>3</sup>	2700 • Warm White 6500 • Daylight 4000 • Cool White	E27	60 x 110	40	180.00
-----------	---	-----	---------------------------	---	-----	----------	----	--------

Non-Dimmable

**3 Step Dimming** 20,000 H 170-240V Wide Voltage 200° Beam Angle ≥85 CRI

EBF8109DL	9 4 1	950	Out-of-scope <sup>3</sup>	6500 • Daylight	E27	60 x 116	60	130.00
EBF8111DL	11 5 1	1265	Out-of-scope <sup>3</sup>	6500 • Daylight	E27	60 x 116	60	145.00

Dimmable. To be used with standard switch only. Not to be used with any dimming devices

15,000 H 120-240V Operating Voltage 200° Beam Angle ≥80 CRI

EBF309DL	9 4.5 1.4	806 484 121	Out-of-scope <sup>3</sup>	6500 • Daylight	E27	60 x 116	60	140.00
----------	-----------------	-------------------	---------------------------	-----------------	-----	----------	----	--------

Dimmable. To be used with standard switch only. Not to be used with any dimming devices

**Water Resistant** 20,000 H\* 100-240V Wide Voltage 230° Beam Angle ≥80 CRI IP54 IP Rating

EBF4109DL	9	806	☆☆☆☆☆	6500 • Daylight	E27	60 x 120	40	130.00
EBF4112DL	12	1300	☆☆☆☆☆	6500 • Daylight	E27	60 x 120	40	150.00

Non-Dimmable  
\*Rated life without using enclosed fixture.

**Water Resistant** 20,000 H 12V DC 220° Beam Angle ≥80 CRI IP54 IP Rating

EBF404DL	4	300	Out-of-scope <sup>3</sup>	6500 • Daylight	E27	60 x 112	25/50	180.00
EBF408DL	8	600	Out-of-scope <sup>3</sup>	6500 • Daylight	E27	60 x 112	25/50	200.00
EBF412DL	12	900	Out-of-scope <sup>3</sup>	6500 • Daylight	E27	65 x 122	25/50	255.00
EBF415DL	15	1425	Out-of-scope <sup>3</sup>	6500 • Daylight	E27	65 x 122	25/50	285.00
EBF418DL	18	1710	Out-of-scope <sup>3</sup>	6500 • Daylight	E27	80 x 142	25/50	320.00

Non-Dimmable  
\*Rated life without using enclosed fixture.

### LED NON A-BULBS

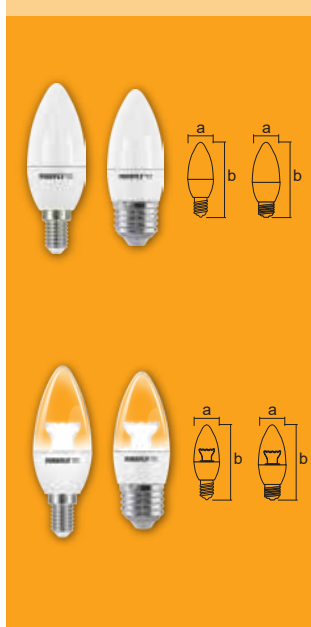

15,000 H 100-240V Wide Voltage 280° Beam Angle ≥85 CRI

**Candle Frosted**

EBC403DL/E27	3	270	☆☆☆☆☆	6500 • Daylight	E27	35 x 98	100	95.00
EBC403DL/E14	3	500	☆☆☆☆☆	6500 • Daylight	E14	35 x 102	100	85.00
EBC403WW/E14	3	250	☆☆☆☆☆	3000 • Warm White	E14	35 x 102	100	85.00
EBC403WW/E27	3	250	☆☆☆☆☆	3000 • Warm White	E27	35 x 98	100	85.00
EBC405DL/E27	5	500	☆☆☆☆☆	6500 • Daylight	E27	35 x 98	100	100.00
EBC405DL/E14	5	470	☆☆☆☆☆	6500 • Daylight	E14	35 x 102	100	90.00
EBC405WW/E14	5	470	☆☆☆☆☆	3000 • Warm White	E14	35 x 102	100	90.00
EBC405WW/E27	5	470	☆☆☆☆☆	3000 • Warm White	E27	35 x 98	100	90.00







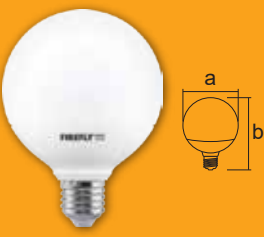

Non-Dimmable

**Candle Clear**

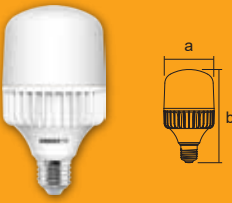
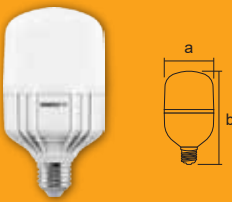









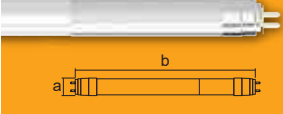



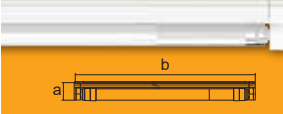



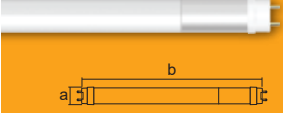



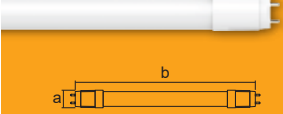





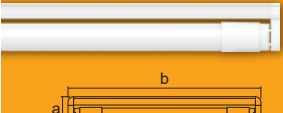



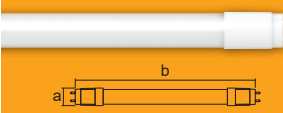

EBC503DL/E14	3	270	☆☆☆☆☆	6500 • Daylight	E14	35 x 102	100	105.00
EBC503WW/E14*	3	250	☆☆☆☆☆	3000 • Warm White	E14	35 x 102	100	105.00
EBC503DL/E27	3	270	☆☆☆☆☆	6500 • Daylight	E27	35 x 98	100	105.00
EBC503WW/E27*	3	250	☆☆☆☆☆	3000 • Warm White	E27	35 x 98	100	105.00
EBC505DL/E14	5	500	☆☆☆☆☆	6500 • Daylight	E14	35 x 102	100	120.00
EBC505WW/E14*	5	470	☆☆☆☆☆	3000 • Warm White	E14	35 x 102	100	120.00
EBC505DL/E27	5	500	☆☆☆☆☆	6500 • Daylight	E27	35 x 98	100	120.00
EBC505WW/E27*	5	470	☆☆☆☆☆	3000 • Warm White	E27	35 x 98	100	120.00

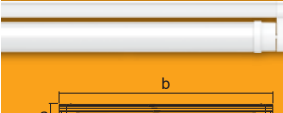
Non-Dimmable  
\*CRI ≥80

LED NON A-BULBS	Wattage	Lumen Output	PELP <sup>1</sup> Star Rating	Color Temperature	Lamp Base	Dimensions	Pkg.	Suggested Retail Price
	W	Lm	1 to 5	K		(a x b mm)	Pcs./Ctn.	SRP
<div style="display: flex; justify-content: space-between; align-items: center;"> <div style="display: flex; flex-direction: column; align-items: center;">           </div> <div style="text-align: right;">      </div> </div>								
<b>Dimmable Filament Candle</b>								
EBC504CD/E14	4	450	Out-of-scope <sup>3</sup>	2700 • Warm White	E14	35 x 98	100	<b>150.00</b>
EBC504CD/E27	4	450	Out-of-scope <sup>3</sup>	2700 • Warm White	E27	35 x 92	100	<b>150.00</b>
<b>Filament Candle</b>								
EBC904WW	4	450	☆☆☆☆☆	2700 • Warm White	E14	35 x 98	100	<b>140.00</b>
EBC904WW/E27	4	450	☆☆☆☆☆	2700 • Warm White	E27	35 x 92	100	<b>140.00</b>
<i>Non-Dimmable</i>								
<b>Filament Classic</b>								
EBI904WW	4	470	☆☆☆☆☆	2700 • Warm White	E27	60 x 105	40	<b>125.00</b>
EBI906WW	6	806	☆☆☆☆☆	2700 • Warm White	E27	60 x 105	40	<b>150.00</b>
EBI909WW	9	1060	☆☆☆☆☆	2700 • Warm White	E27	60 x 105	40	<b>170.00</b>
<i>Non-Dimmable</i>								
<b>Filament Mini Classic</b>								
EBI904WW/1	4	450	☆☆☆☆☆	2700 • Warm White	E27	45 x 80	100	<b>125.00</b>
<i>Non-Dimmable</i>								
<b>Filament Full Light</b>								
EBI704WW	4	470	☆☆☆☆☆	2700 • Warm White	E27	60 x 105	50	<b>200.00</b>
<i>Non-Dimmable</i>								
<b>Filament Vintage Candle</b>								
EBC803WW	3	200	Out-of-scope <sup>3</sup>	2000 • Warm White	E14	35 x 98	100	<b>175.00</b>
<i>Non-Dimmable</i>								
<b>Filament Vintage</b>								
EBI804WW	4	320	Out-of-scope <sup>3</sup>	2000 • Warm White	E27	60 x 105	40	<b>180.00</b>
<i>Non-Dimmable</i>								
<b>Filament Vintage Globe</b>								
EBG805WW	5	470	Out-of-scope <sup>3</sup>	2000 • Warm White	E27	95 x 138	20	<b>310.00</b>
<i>Non-Dimmable</i>								
<b>Filament Vintage Pear</b>								
EBST805WW	5	470	Out-of-scope <sup>3</sup>	2000 • Warm White	E27	64 x 145	40	<b>280.00</b>
<i>Non-Dimmable</i>								
<b>Colored Filament</b>								
EBST801C	1	-	Out-of-scope <sup>3</sup>	2200 • Clear	E27	44 x 80	100	<b>50.00</b>
EBST801B	1	-	Out-of-scope <sup>3</sup>	100000 • Blue	E27	44 x 80	100	<b>50.00</b>
EBST801R	1	-	Out-of-scope <sup>3</sup>	1000 • Red	E27	44 x 80	100	<b>50.00</b>
EBST801G	1	-	Out-of-scope <sup>3</sup>	8000 • Green	E27	44 x 80	100	<b>50.00</b>
EBST801Y	1	-	Out-of-scope <sup>3</sup>	3200 • Yellow	E27	44 x 80	100	<b>50.00</b>
<i>Non-Dimmable</i>								

LED NON A-BULBS		Wattage	Lumen Output	PELP <sup>1</sup> Star Rating	Color Temperature	Lamp Base	Dimensions	Pkg.	Suggested Retail Price	
		W	Lm	1 to 5	K		(a x b mm)	Pcs./Ctn.	SRP	
					15,000 H	220-240V Operating Voltage	220° Beam Angle	80 CRI		
		Globe								
		EBG112DL	12	1060	☆☆☆☆☆	6500 • Daylight	E27	95 x 128	20	255.00
		EBG112WW	12	1040	☆☆☆☆☆	3000 • Warm White	E27	95 x 128	20	255.00
		EBG114DL	14	1300	☆☆☆☆☆	6500 • Daylight	E27	95 x 128	20	290.00
		EBG114WW	14	1250	☆☆☆☆☆	3000 • Warm White	E27	95 x 128	20	290.00
		EBG116DL	16	1520	☆☆☆☆☆	6500 • Daylight	E27	95 x 128	20	350.00
EBG116WW	16	1520	☆☆☆☆☆	3000 • Warm White	E27	95 x 128	20	350.00		
EBG120DL	20	1920	☆☆☆☆☆	6500 • Daylight	E27	95 x 128	20	385.00		
		Non-Dimmable								
					15,000 H	100-240V Wide Voltage	200° Beam Angle	≥80 CRI		
		Tubular								
		EBT107DL	7	700	☆☆☆☆☆	6500 • Daylight	E27	38 x 115	60	115.00
EBT111DL	11	1100	☆☆☆☆☆	6500 • Daylight	E27	45 x 135	60	150.00		
		Non-Dimmable								
					15,000 H	120-240V Wide Voltage	220° Beam Angle	85 CRI		
		Capsule								
		EHC220DL	20	2000	☆☆☆☆☆	6500 • Daylight	E27	150 x 80	20	300.00
		EHC230DL	30	3000	With COE <sup>2</sup>	6500 • Daylight	E27	180 x 100	10	430.00
EHC240DL	40	4000	With COE <sup>2</sup>	6500 • Daylight	E27	210 x 118	10	620.00		
EHC250DL	50	5000	With COE <sup>2</sup>	6500 • Daylight	E27	238 x 135	8	790.00		
		Non-Dimmable Material: Diecast Aluminum Body								
					20,000 H	120-240V Wide Voltage	220° Beam Angle	80 CRI		
		Capsule								
		EHC120DL	20	1700	With COE <sup>2</sup>	6500 • Daylight	E27	80 x 150	20	390.00
		EHC120CW	20	1700	With COE <sup>2</sup>	4000 • Cool White	E27	80 x 150	20	390.00
		EHC128DL	28	2400	With COE <sup>2</sup>	6500 • Daylight	E27	100 x 185	10	515.00
		EHC128CW	28	2400	With COE <sup>2</sup>	4000 • Cool White	E27	100 x 185	10	515.00
EHC138DL	38	3000	With COE <sup>2</sup>	6500 • Daylight	E27	118 x 220	10	730.00		
EHC145DL	45	4000	With COE <sup>2</sup>	6500 • Daylight	E27	140 x 260	10	895.00		
		Non-Dimmable								
					25,000 H	100-240V Wide Voltage	25° Beam Angle	80 CRI	IP65 IP Rating	
		PAR38								
		EBP910DL	10	1050	Out-of-scope <sup>3</sup>	6500 • Daylight	E27	121 x 136	20	375.00
		EBP910WW	10	1000	Out-of-scope <sup>3</sup>	3000 • Warm White	E27	121 x 136	20	375.00
EBP914DL	14	1460	Out-of-scope <sup>3</sup>	6500 • Daylight	E27	121 x 136	20	410.00		
EBP914WW	14	1400	Out-of-scope <sup>3</sup>	3000 • Warm White	E27	121 x 136	20	410.00		
		Non-Dimmable								
					15,000 H	100-240V Wide Voltage	36° Beam Angle	85 CRI		
		MR16								
		EBH403DLG53	3	255	Out-of-scope <sup>3</sup>	6500 • Daylight	GU5.3	50 X 45	100	90.00
		EBH403WWG53	3	240	Out-of-scope <sup>3</sup>	3000 • Warm White	GU5.3	50 X 45	100	90.00
EBH405DLG53	5	470	Out-of-scope <sup>3</sup>	6500 • Daylight	GU5.3	50 X 45	100	100.00		
EBH405WWG53	5	430	Out-of-scope <sup>3</sup>	3000 • Warm White	GU5.3	50 X 45	100	100.00		
		Non-Dimmable								
					15,000 H	100-240V Wide Voltage	36° Beam Angle	80 CRI		
		MR16								
		EBH403DLG10	3	260	Out-of-scope <sup>3</sup>	6500 • Daylight	GU10	54 x 50	100	95.00
		EBH403WWG10	3	250	Out-of-scope <sup>3</sup>	3000 • Warm White	GU10	54 x 50	100	95.00
EBH405DLG10	5	480	Out-of-scope <sup>3</sup>	6500 • Daylight	GU10	54 x 50	100	110.00		
EBH405WWG10	5	450	Out-of-scope <sup>3</sup>	3000 • Warm White	GU10	54 x 50	100	110.00		
		Non-Dimmable								
					15,000 H	100-240V Operating Voltage	36° Beam Angle	≥85 CRI		
		<b>New!</b> 2-COLOR LAMP								
EBH404TCG10	4	400 360	Out-of-scope <sup>3</sup>	6500 • Daylight 2700 • Warm White	GU10	60 x 110	100	140.00		
		Non-Dimmable								
					15,000 H	100-240V Wide Voltage	36° Beam Angle	80 CRI		
		MR16								
EBH303WWE27	3.5	250	Out-of-scope <sup>3</sup>	3000 • Warm White	E27	50 x 76	100	145.00		
EBH305WWE27	5	350	Out-of-scope <sup>3</sup>	3000 • Warm White	E27	50 x 76	100	155.00		
		Non-Dimmable								

BASIC Series

LED TUBES	Wattage	Lumen Output	PELP <sup>1</sup> Star Rating	Color Temperature	Lamp Base	Dimensions	Pkg.	Suggested Retail Price
	W	Lm	1 to 5	K		(a x b mm)	Pcs./Ctn.	SRP
<div style="display: flex; justify-content: space-between; align-items: center;">  <div style="text-align: center;">   <b>20,000 H</b> </div> <div style="text-align: center;"> <b>220-240V</b>                      Wide Voltage                 </div> <div style="text-align: center;">   <b>180°</b>                      Beam Angle                 </div> <div style="text-align: center;">   <b>≥80</b>                      CRI                 </div> </div>								
ELTS31T508DL	8	900	☆☆☆☆☆	6500 • Daylight	G5	17 x 600	20	<b>165.00</b>
ELTS31T508WW	8	865	☆☆☆☆☆	3000 • Warm White	G5	17 x 600	20	<b>165.00</b>
ELTS31T508CW	8	900	☆☆☆☆☆	4000 • Cool White	G5	17 x 600	20	<b>165.00</b>
ELTS31T516DL	16	1800	☆☆☆☆☆	6500 • Daylight	G5	17 x 1200	20	<b>220.00</b>
ELTS31T516WW	16	1730	☆☆☆☆☆	3000 • Warm White	G5	17 x 1200	20	<b>220.00</b>
ELTS31T516CW	16	1800	☆☆☆☆☆	4000 • Cool White	G5	17 x 1200	20	<b>220.00</b>
Non-Dimmable *Replacement tube for EBTS31								
<div style="display: flex; justify-content: space-between; align-items: center;">  <div style="text-align: center;">   <b>20,000 H</b> </div> <div style="text-align: center;"> <b>220-240V</b>                      Wide Voltage                 </div> <div style="text-align: center;">   <b>180°</b>                      Beam Angle                 </div> <div style="text-align: center;">   <b>≥80</b>                      CRI                 </div> </div>								
EBTS31/DL08	8	900	☆☆☆☆☆	6500 • Daylight	G5	35 x 600	20	<b>240.00</b>
EBTS31/WW08	8	865	☆☆☆☆☆	3000 • Warm White	G5	35 x 600	20	<b>240.00</b>
EBTS31/CW08	8	900	☆☆☆☆☆	4000 • Cool White	G5	35 x 600	20	<b>240.00</b>
EBTS31/DL16	16	1945	☆☆☆☆☆	6500 • Daylight	G5	35 x 1200	20	<b>330.00</b>
EBTS31/WW16	16	1800	☆☆☆☆☆	3000 • Warm White	G5	35 x 1200	20	<b>330.00</b>
EBTS31/CW16	16	1800	☆☆☆☆☆	4000 • Cool White	G5	35 x 1200	20	<b>330.00</b>
Non-Dimmable *Use Double-ended LED tube as replacemnt								
<div style="display: flex; justify-content: space-between; align-items: center;">  <div style="text-align: center;">   <b>20,000 H</b> </div> <div style="text-align: center;"> <b>220-240V</b>                      Operating Voltage                 </div> <div style="text-align: center;">   <b>180°</b>                      Beam Angle                 </div> <div style="text-align: center;">   <b>≥80</b>                      CRI                 </div> </div>								
EFS04T8DL09	9	1080	☆☆☆☆☆	6500 • Daylight	G13	25.4 x 600	25	<b>160.00</b>
EFS04T8DL18	18	2160	☆☆☆☆☆	6500 • Daylight	G13	25.4 x 1200	25	<b>210.00</b>
Non-Dimmable								
<div style="display: flex; justify-content: space-between; align-items: center;">  <div style="text-align: center;">   <b>20,000 H</b> </div> <div style="text-align: center;"> <b>100-240V</b>                      Wide Voltage                 </div> <div style="text-align: center;">   <b>200°</b>                      Beam Angle                 </div> <div style="text-align: center;">   <b>≥80</b>                      CRI                 </div> <div style="text-align: center;">  </div> </div>								
EFS03T8DL09	9	1080	☆☆☆☆☆	6500 • Daylight	G13	25.4 x 600	20	<b>160.00</b>
EFS03T8DL18	18	2250	☆☆☆☆☆	6500 • Daylight	G13	25.4 x 1200	20	<b>210.00</b>
Non-Dimmable *Replacement tube for EBTS11/DL09 & EBTS11/DL18								
 <b>Accessory: LED Tube Clip Holder</b> LAX442 SRP: <b>55.00</b>								
<div style="display: flex; justify-content: space-between; align-items: center;">  <div style="text-align: center;">   <b>20,000 H</b> </div> <div style="text-align: center;"> <b>100-240V</b>                      Wide Voltage                 </div> <div style="text-align: center;">   <b>200°</b>                      Beam Angle                 </div> <div style="text-align: center;">   <b>≥80</b>                      CRI                 </div> <div style="text-align: center;">  </div> </div>								
EBTS11/DL09	9	1080	☆☆☆☆☆	6500 • Daylight	G13	43 x 606	20	<b>230.00</b>
EBTS11/DL18	18	2250	☆☆☆☆☆	6500 • Daylight	G13	43 x 1222	20	<b>300.00</b>
Non-Dimmable *Use Single-ended LED tube as replacement								
<div style="display: flex; justify-content: space-between; align-items: center;">  <div style="text-align: center;">   <b>20,000 H</b> </div> <div style="text-align: center;"> <b>220-240V</b>                      Wide Voltage                 </div> <div style="text-align: center;">   <b>180°</b>                      Beam Angle                 </div> <div style="text-align: center;">   <b>≥80</b>                      CRI                 </div> </div>								
EFS06T8DL08	8	960	☆☆☆☆☆	6500 • Daylight	G13	25.4 x 60	25	<b>140.00</b>
EFS06T8DL16	16	1920	☆☆☆☆☆	6500 • Daylight	G13	25.4 x 1200	25	<b>180.00</b>
Non-Dimmable *Replacement tube for EBTS12/DL08 & EBTS12/DL16								
<div style="display: flex; justify-content: space-between; align-items: center;">  <div style="text-align: center;">   <b>20,000 H</b> </div> <div style="text-align: center;"> <b>220-240V</b>                      Wide Voltage                 </div> <div style="text-align: center;">   <b>180°</b>                      Beam Angle                 </div> <div style="text-align: center;">   <b>≥80</b>                      CRI                 </div> </div>								
EBTS12/DL08	8	960	☆☆☆☆☆	6500 • Daylight	G13	43 x 606	24	<b>200.00</b>
EBTS12/DL16	16	1920	☆☆☆☆☆	6500 • Daylight	G13	43 x 1222	24	<b>270.00</b>
Non-Dimmable *Use Single-ended LED tube as replacement								
<div style="display: flex; justify-content: space-between; align-items: center;">  <div style="text-align: center;">   <b>15,000 H</b> </div> <div style="text-align: center;"> <b>220-240V</b>                      Operating Voltage                 </div> <div style="text-align: center;">   <b>180°</b>                      Beam Angle                 </div> <div style="text-align: center;">   <b>85</b>                      CRI                 </div> </div>								
ECL815DL	15	1500	Out-of-scope <sup>3</sup>	6500 • Daylight	E27	Ø260 x 85	20	<b>400.00</b>
ECL820DL	20	1650	Out-of-scope <sup>3</sup>	6500 • Daylight	E27	Ø260 x 85	20	<b>540.00</b>
Non-Dimmable								

LED BATTENS	Wattage	Lumen Output	Color Temperature	Dimmable	Dimensions	Packaging	Suggested Retail Price
	W	Lm	K	Yes/No	(a x b x c mm)	Pcs./Ctn.	SRP



**T5 Batten** 15,000 H 165-250V 180° ≥80

Model	Wattage	Lumen Output	Color Temperature	Dimmable	Dimensions	Packaging	Suggested Retail Price
EBTST5DL305	5	400	6500 • Daylight	no	34.3 x 315 x 22	25	175.00
EBTST5WW305	5	350	3000 • Warm White	no	34.3 x 315 x 22	25	175.00
EBTST5CW305	5	400	4000 • Cool White	no	34.3 x 315 x 22	25	175.00
EBTST5DL308	8	700	6500 • Daylight	no	34.3 x 575 x 22	25	220.00
EBTST5WW308	8	650	3000 • Warm White	no	34.3 x 575 x 22	25	220.00
EBTST5CW308	8	700	4000 • Cool White	no	34.3 x 575 x 22	25	220.00
EBTST5DL314	14	1200	6500 • Daylight	no	34.3 x 1024 x 22	25	290.00
EBTST5WW314	14	1100	3000 • Warm White	no	34.3 x 1024 x 22	25	290.00
EBTST5CW314	14	1200	4000 • Cool White	no	34.3 x 1024 x 22	25	290.00
EBTST5DL316	16	1500	6500 • Daylight	no	34.3 x 1175 x 22	25	315.00
EBTST5WW316	16	1400	3000 • Warm White	no	34.3 x 1175 x 22	25	315.00
EBTST5CW316	16	1500	4000 • Cool White	no	34.3 x 1175 x 22	25	315.00

**T5 Batten** 25,000 H 100-240V 110° 80

Model	Wattage	Lumen Output	Color Temperature	Dimmable	Dimensions	Packaging	Suggested Retail Price
EBTST5DL05	5	450	6500 • Daylight	no	36 x 300	60	225.00
EBTST5WW05	5	400	3000 • Warm White	no	36 x 300	60	225.00
EBTST5DL10	10	900	6500 • Daylight	no	36 x 585	30	345.00
EBTST5WW10	10	800	3000 • Warm White	no	36 x 585	30	345.00
EBTST5DL20	20	1800	6500 • Daylight	no	36 x 1185	30	540.00
EBTST5WW20	20	1600	3000 • Warm White	no	36 x 1185	30	540.00

**New!** **Cabinet Lamp** 20,000 H 170-240V 200° 85

Model	Wattage	Lumen Output	Color Temperature	Dimmable	Dimensions	Packaging	Suggested Retail Price
EBTS1018DL	18	1800	6500 • Daylight	no	25 x 596 x 75	30	420.00
EBTS1036DL	36	3600	6500 • Daylight	no	25 x 1196 x 75	30	670.00

### LED WEATHERPROOF LAMPS

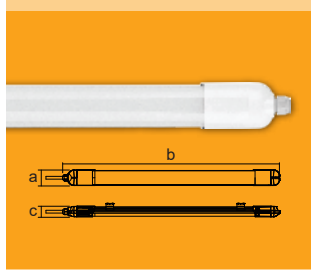

**3P LED Integrated Luminaire** 20,000 H 176-265V 110° ≥80 IP65

Model	Wattage	Lumen Output	Color Temperature	Dimmable	Dimensions	Packaging	Suggested Retail Price
EWP1009DL	9	810	6500 • Daylight	no	50 x 689 x 43	45	735.00
EWP1018DL	18	1620	6500 • Daylight	no	50 x 1180 x 43	45	1,000.00
EWP1036DL	36	3240	6500 • Daylight	no	66 x 1187 x 48	45	1,440.00



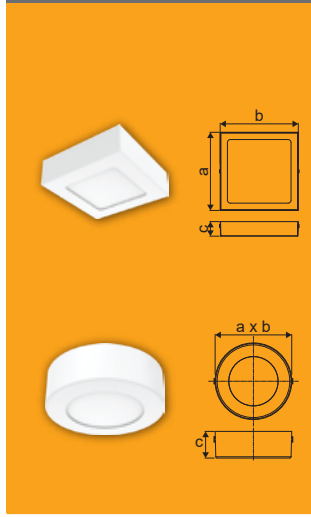





LED DOWNLIGHTS	Wattage	Lumen Output	Color Temperature	Dimensions	Cut-out Size	PKG.	Suggested Retail Price
	W	Lm	K	(a x b x c mm)	mm	Pcs./Ctn.	SRP

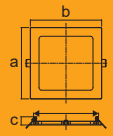

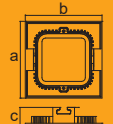
**Surface Slim** 25,000 H 100-240V 110° ≥80

EDL113606DL	6	360	6500 • Daylight	115 x 115 x 35	-	20	325.00 ↓
EDL113606WW	6	320	3000 • Warm White	115 x 115 x 35	-	20	325.00 ↓
EDL113612DL	12	800	6500 • Daylight	165 x 165 x 35	-	10	450.00 ↓
EDL113612WW	12	720	3000 • Warm White	165 x 165 x 35	-	10	450.00 ↓
EDL113618DL	18	1300	6500 • Daylight	215 x 215 x 35	-	10	610.00 ↓
EDL113618WW	18	1200	3000 • Warm White	215 x 215 x 35	-	10	610.00 ↓
EDL213606DL	6	360	6500 • Daylight	∅ 115 x 35	-	20	325.00 ↓
EDL213606WW	6	320	3000 • Warm White	∅ 115 x 35	-	20	325.00 ↓
EDL213612DL	12	800	6500 • Daylight	∅ 165 x 35	-	10	450.00 ↓
EDL213612WW	12	720	3000 • Warm White	∅ 165 x 35	-	10	450.00 ↓
EDL213618DL	18	1300	6500 • Daylight	∅ 215 x 35	-	10	610.00 ↓
EDL213618WW	18	1200	3000 • Warm White	∅ 215 x 35	-	10	610.00 ↓

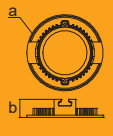

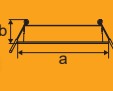
LED DOWNLIGHTS		Wattage	Lumen Output	Color Temperature	Dimensions	Cut-out Size	PKG.	Suggested Retail Price
		W	Lm	K	(a x b x c mm)	mm	Pcs./Ctn.	SRP
 	Recessed Slim		25,000 H	100-240V Wide Voltage	110° Beam Angle	≥80 CRI	ULTRA-THIN For low ceiling clearance installation	
	EDL112603DL	3	180	6500 • Daylight	80 x 80 x 24	75 x 75	40	215.00 ↓
	EDL112603WW	3	180	3000 • Warm White	80 x 80 x 24	75 x 75	40	215.00 ↓
	EDL112603CW	3	185	4000 • Cool White	85 x 85 x 22	75 x 75	20	215.00 ↓
	EDL112606DL	6	360	6500 • Daylight	115 x 115 x 19	100 x 100	20	280.00 ↓
	EDL112606WW	6	320	3000 • Warm White	115 x 115 x 19	100 x 100	20	280.00 ↓
	EDL112606CW	6	390	4000 • Cool White	120 x 120 x 22	100 x 100	20	280.00 ↓
	EDL112609DL	9	585	6500 • Daylight	147 x 147 x 22	130 x 130	20	340.00 ↓
	EDL112609WW	9	540	3000 • Warm White	147 x 147 x 22	130 x 130	20	340.00 ↓
	EDL112609CW	9	585	4000 • Cool White	147 x 147 x 22	130 x 130	20	340.00 ↓
	EDL112612DL	12	800	6500 • Daylight	165 x 165 x 19	150 x 150	20	385.00 ↓
	EDL112612WW	12	720	3000 • Warm White	165 x 165 x 19	150 x 150	20	385.00 ↓
	EDL112612CW	12	840	4000 • Cool White	170 x 170 x 22	150 x 150	20	385.00 ↓
	EDL112615DL	15	1275	6500 • Daylight	190 x 190 x 22	175 x 175	20	475.00 ↓
EDL112615WW	15	1150	3000 • Warm White	190 x 190 x 22	175 x 175	20	475.00 ↓	
EDL112615CW	15	1275	4000 • Cool White	190 x 190 x 22	175 x 175	20	475.00 ↓	
EDL112618DL	18	1300	6500 • Daylight	215 x 215 x 19	200 x 200	20	510.00 ↓	
 	Recessed Slim		20,000 H	110-240V Wide Voltage	120° Beam Angle	≥80 CRI	ULTRA-THIN For low ceiling clearance installation	
	EDL1218DL	18	1300	6000 • Daylight	225 x 225 x 20.2	210 x 210	20	550.00
	EDL1224DL	24	1700	6000 • Daylight	300 x 300 x 20.3	285 x 285	20	850.00
 	Recessed Slim		25,000 H	100-240V Wide Voltage	110° Beam Angle	≥80 CRI	ULTRA-THIN For low ceiling clearance installation	
	EDL212603DL	3	180	6500 • Daylight	Ø 80 x 24	Ø 75	40	215.00 ↓
	EDL212603WW	3	180	3000 • Warm White	Ø 80 x 24	Ø 75	40	215.00 ↓
	EDL212603CW	3	185	4000 • Cool White	Ø 90 x 19	Ø 70	20	215.00 ↓
	EDL212606DL	6	360	6500 • Daylight	Ø 115 x 19	Ø 100	20	280.00 ↓
	EDL212606WW	6	320	3000 • Warm White	Ø 115 x 19	Ø 100	20	280.00 ↓
	EDL212606CW	6	390	4000 • Cool White	Ø 120 x 19	Ø 100	20	280.00 ↓
	EDL212609DL	9	585	6500 • Daylight	Ø 150 x 19	Ø 130	20	340.00 ↓
	EDL212609WW	9	540	3000 • Warm White	Ø 150 x 19	Ø 130	20	340.00 ↓
	EDL212609CW	9	540	4000 • Cool White	Ø 150 x 19	Ø 130	20	340.00 ↓
	EDL212612DL	12	800	6500 • Daylight	Ø 165 x 19	Ø 150	20	385.00 ↓
	EDL212612WW	12	720	3000 • Warm White	Ø 165 x 19	Ø 150	20	385.00 ↓
	EDL212612CW	12	840	4000 • Cool White	Ø 170 x 20	Ø 150	20	385.00 ↓
	EDL212615DL	15	1275	6500 • Daylight	Ø 190 x 20	Ø 175	20	475.00 ↓
EDL212615WW	15	1150	3000 • Warm White	Ø 190 x 20	Ø 175	20	475.00 ↓	
EDL212615CW	15	1275	4000 • Cool White	Ø 190 x 20	Ø 175	20	475.00 ↓	
EDL212618DL	18	1300	6500 • Daylight	Ø 215 x 19	Ø 200	20	510.00 ↓	
 	Recessed Slim		20,000 H	110-240V Wide Voltage	120° Beam Angle	≥80 CRI	ULTRA-THIN For low ceiling clearance installation	
	EDL2203WW	3	180	3000 • Warm White	Ø 84.5 x 20	Ø 70	40	180.00
	EDL2209WW	9	570	3000 • Warm White	Ø 146 x 20	Ø 130	40	370.00
	EDL2212DL	12	800	6000 • Daylight	Ø 174 x 20	Ø 155	20	420.00
	EDL2215DL	15	1000	6000 • Daylight	Ø 199 x 20.2	Ø 185	20	490.00
	EDL2218DL	18	1300	6000 • Daylight	Ø 223.5 x 20.2	Ø 210	20	550.00
EDL2224DL	24	1700	6000 • Daylight	Ø 297 x 20.2	Ø 285	20	850.00	
 	Backlit Slim		25,000 H	220-240V Operating Voltage	100° Beam Angle	≥85 CRI		
	EDL218006DL	6	450	6500 • Daylight	31.5 x 120	Ø 110	20	255.00
	EDL218006WW	6	420	3000 • Warm White	31.5 x 120	Ø 110	20	255.00
	EDL218009DL	9	765	6500 • Daylight	31.5 x 120	Ø 110	20	295.00 ↓
	EDL218012DL	12	900	6500 • Daylight	31.5 x 170	Ø 158	20	360.00
	EDL218012WW	12	850	3000 • Warm White	31.5 x 170	Ø 158	20	360.00
	EDL218015DL	15	1320	6500 • Daylight	31.5 x 170	Ø 158	20	425.00
	EDL218018DL	18	1530	6500 • Daylight	31.5 x 225	Ø 210	20	470.00
EDL218018WW	18	1450	3000 • Warm White	31.5 x 225	Ø 210	20	470.00	

LED DOWNLIGHTS		Wattage	Lumen Output	Color Temperature	Dimensions	Cut-out Size	PKG.	Suggested Retail Price	
		W	Lm	K	(a x b x c mm)	mm	Pcs./Ctn.	SRP	
		<b>Frameless</b>		25,000 H	170-240V Wide Voltage	100° Beam Angle	≥85 CRI		
		EDL129106DL*	6	720	6500 • Daylight	115 x 42	90 x 90	20	270.00
		EDL129106WW*	6	690	3000 • Warm White	115 x 42	90 x 90	20	270.00
		EDL129109DL	9	1035	6500 • Daylight	115 x 42	90 x 90	20	345.00
		EDL129109WW	9	990	3000 • Warm White	115 x 42	90 x 90	20	345.00
		EDL129112DL	12	1560	6500 • Daylight	135 x 42	110 x 110	20	380.00
EDL129112WW	12	1440	3000 • Warm White	135 x 42	110 x 110	20	380.00		
		<b>Integrated</b>		15,000 H	170-240V Wide Voltage	100° Beam Angle	≥80 CRI		
		EDL223203DL	3	210	6500 • Daylight	49.5 x Ø 92	Ø 70 - 80	60	130.00
		EDL223203WW	3	195	3000 • Warm White	49.5 x Ø 92	Ø 70 - 80	60	130.00
		EDL223205DL	5	500	6500 • Daylight	49.5 x Ø 114	Ø 90 - 102	60	160.00
		EDL223205WW	5	475	3000 • Warm White	49.5 x Ø 114	Ø 90 - 102	60	160.00
		EDL223207DL	7	700	6500 • Daylight	49.5 x Ø 114	Ø 90 - 102	60	220.00
		EDL223207WW	7	650	3000 • Warm White	49.5 x Ø 114	Ø 90 - 102	60	220.00
		EDL223209DL	9	900	6500 • Daylight	50 x Ø 127	Ø 105 - 115	60	270.00
		EDL223209WW	9	835	3000 • Warm White	50 x Ø 127	Ø 105 - 115	60	270.00
		EDL223212DL	12	1200	6500 • Daylight	55 x Ø 144	Ø 120 - 130	60	300.00
EDL223212WW	12	1100	3000 • Warm White	55 x Ø 144	Ø 120 - 130	60	300.00		
		*150-240V							
		Material: Polycarbonate							
		<b>Integrated</b>		20,000 H	100-240V Wide Voltage	90° Beam Angle	≥80 CRI		
		EDL222203DL	3	270	6500 • Daylight	50 x Ø 92	Ø 75	30	125.00
		EDL222203WW	3	250	3000 • Warm White	50 x Ø 92	Ø 75	30	125.00
		EDL222206DL	6	540	6500 • Daylight	50 x Ø 92	Ø 75	30	160.00
		EDL222206WW	6	500	3000 • Warm White	50 x Ø 92	Ø 75	30	160.00
		EDL222209DL	9	810	6500 • Daylight	50 x Ø 112	Ø 100	20	210.00
		EDL222209WW	9	750	3000 • Warm White	50 x Ø 112	Ø 100	20	210.00
		EDL222212DL	12	1080	6500 • Daylight	54 x Ø 166	Ø 150	20	270.00
		EDL222212WW	12	1000	3000 • Warm White	54 x Ø 166	Ø 150	20	270.00
		EDL222215DL	15	1350	6500 • Daylight	54 x Ø 166	Ø 150	20	310.00
EDL222215WW	15	1250	3000 • Warm White	54 x Ø 166	Ø 150	20	310.00		
		<b>Integrated</b>		20,000 H	100-240V Wide Voltage	100° Beam Angle	≥80 CRI		
		EDL2508DL	8	800	6500 • Daylight	68.5 x Ø 115	Ø 90 - 102	24	375.00
		EDL2509DL	9	900	6500 • Daylight	78.5 x Ø 145	Ø 120 - 130	24	440.00
		EDL2512DL	12	1200	6500 • Daylight	84.5 x Ø 197	Ø 145 - 155	12	575.00
		EDL2519DL	19	1900	6500 • Daylight	98.5 x Ø 245	Ø 195 - 210	12	810.00

\*Cut-out: Same size as traditional downlight fixtures.

### FUNCTIONAL LED DOWNLIGHTS

3-COLOR RECESSED SLIM DOWNLIGHT		Wattage	Lumen Output	Color Temperature	Dimensions	Cut-out Size	PKG.	Suggested Retail Price	
		W	Lm	K	(a x b x c mm)	mm	Pcs./Ctn.	SRP	
		<b>3-COLOR RECESSED SLIM DOWNLIGHT</b>		25,000 H	150-240V Operating Voltage	120° Beam Angle	85 CRI		
		EDL112603TC	3	150 120 150	6500 • Daylight 3000 • Warm White 4000 • Cool White	85 x 85 x 23	75 x 75	40	270.00
		EDL112606TC	6	330 300 330	6500 • Daylight 3000 • Warm White 4000 • Cool White	120 x 120 x 23	115 x 115	20	350.00
		EDL112609TC	9	600 570 600	6500 • Daylight 3000 • Warm White 4000 • Cool White	146 x 146 x 23	138 x 138	20	450.00
		EDL112612TC	12	900 850 900	6500 • Daylight 3000 • Warm White 4000 • Cool White	171 x 171 x 23	162 x 162	20	540.00

BASIC Series

FUNCTIONAL LED DOWNLIGHTS	Wattage	Lumen Output	Color Temperature	Dimensions	Cut-out Size	PKG.	Suggested Retail Price
	W	Lm	K	(a x b x c mm)	mm	Pcs./Ctn.	SRP

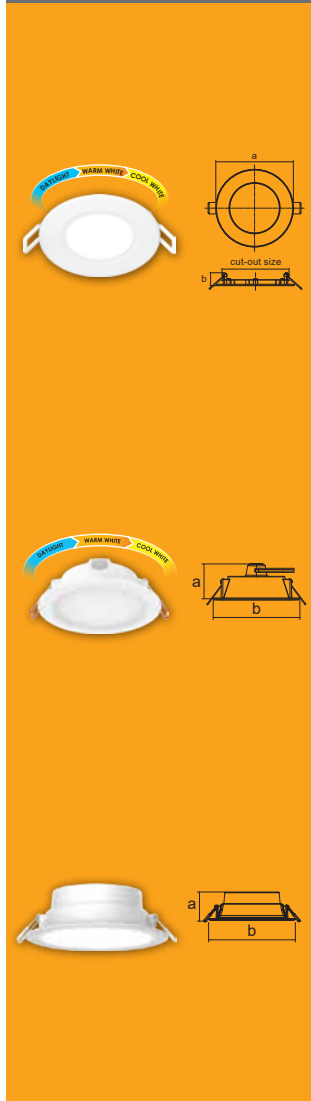

**New!**

**3-COLOR RECESSED SLIM DOWNLIGHT**

25,000 H 150-240V Operating Voltage 120° Beam Angle 85 CRI

EDL212603TC	3	150 120 150	6500 • Daylight 3000 • Warm White 4000 • Cool White	Ø 85 x 23	Ø 75	40	270.00
EDL212606TC	6	330 300 330	6500 • Daylight 3000 • Warm White 4000 • Cool White	Ø 120 x 23	Ø 115	20	350.00
EDL212609TC	9	600 570 600	6500 • Daylight 3000 • Warm White 4000 • Cool White	Ø 146 x 23	Ø 138	20	450.00
EDL212612TC	12	900 850 900	6500 • Daylight 3000 • Warm White 4000 • Cool White	Ø 171 x 23	Ø 162	20	540.00

**3-COLOR INTEGRATED**

20,000 H 110-240V Wide Voltage 90° Beam Angle ≥85 CRI

EDL222203TC	3	295 240 295	6500 • Daylight 3000 • Warm White 4000 • Cool White	50 x Ø92	Ø 75	40	160.00
EDL222206TC	6	575 470 575	6500 • Daylight 3000 • Warm White 4000 • Cool White	55 x Ø92	Ø 75	40	200.00
EDL222209TC	9	900 775 900	6500 • Daylight 3000 • Warm White 4000 • Cool White	55 x Ø112	Ø 100	30	260.00

**3 Step Dimming**

15,000 H 170-240V Wide Voltage 100° Beam Angle ≥85 CRI

EDL228009DL	9 4 1	900 400 135	6500 • Daylight	50 x Ø 127	Ø 88 - 110	40	280.00
EDL228012DL	12 5 2	1260 600 250	6500 • Daylight	55 x Ø 144	Ø 131 - 140	30	315.00
EDL228015DL	15 6 3	1800 900 360	6500 • Daylight	55 x Ø 169	Ø 141 - 165	30	430.00

Material: Polycarbonate

### LED TILTABLE DOWNLIGHTS

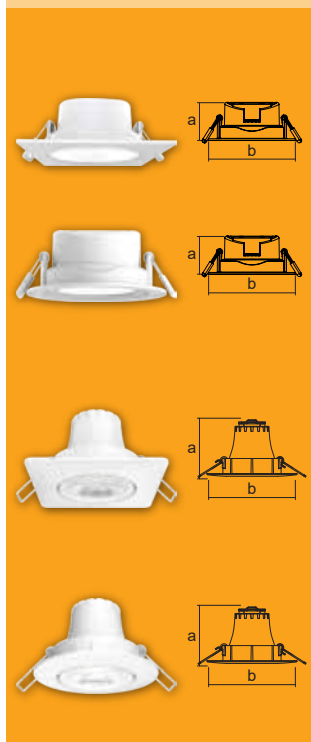

**Tiltable Uni-directional 20,000 H** 110-240V Wide Voltage 38° Beam Angle ≥85 CRI

EDL1608DL	8	850	6500 • Daylight	52 x 110	90 x 90	30	275.00
EDL1608WW	8	800	3000 • Warm White	52 x 110	90 x 90	30	275.00
EDL2608DL	8	800	6500 • Daylight	52 x Ø 110	Ø 90	30	275.00
EDL2608WW	8	720	3000 • Warm White	52 x Ø 110	Ø 90	30	275.00

Material: Polycarbonate

**Tiltable Uni-directional 20,000 H** 100-240V Wide Voltage 36° Beam Angle ≥80 CRI

EDL1503DL	3	250	6500 • Daylight	56 x 90	68 x 68	40	160.00
EDL1503WW	3	230	3000 • Warm White	56 x 90	68 x 68	40	160.00
EDL1505DL	5	450	6500 • Daylight	56 x 90	68 x 68	40	200.00
EDL1505WW	5	420	3000 • Warm White	56 x 90	68 x 68	40	200.00
EDL2503DL	3	250	6500 • Daylight	56 x Ø 90	Ø 68	40	160.00
EDL2503WW	3	230	3000 • Warm White	56 x Ø 90	Ø 68	40	160.00
EDL2505DL	5	450	6500 • Daylight	56 x Ø 90	Ø 68	40	200.00
EDL2505WW	5	420	3000 • Warm White	56 x Ø 90	Ø 68	40	200.00

Material: Polycarbonate

LED TILTABLE DOWNLIGHTS		Wattage	Lumen Output	Color Temperature	Dimensions	Cut-out Size	PKG.	Suggested Retail Price
		W	Lm	K	(a x b x c mm)	mm	Pcs./Ctn.	SRP
		<b>Tiltable</b>		20,000 H 100-240V Wide Voltage 36° Beam Angle ≥80 CRI Uni-directional	EDL1403DL 3 240 6500 • Daylight 56 x 80 68 x 68 40 <b>225.00</b> EDL1403WW 3 230 3000 • Warm White 56 x 80 68 x 68 40 <b>225.00</b> EDL1406DL 6 435 6500 • Daylight 56 x 80 68 x 68 40 <b>240.00</b> EDL1406WW 6 415 3000 • Warm White 56 x 80 68 x 68 40 <b>240.00</b>			
		EDL2403DL 3 240 6500 • Daylight 56 x Ø 80 Ø 68 40 <b>225.00</b> EDL2403WW 3 230 3000 • Warm White 56 x Ø 80 Ø 68 40 <b>225.00</b> EDL2406DL 6 435 6500 • Daylight 56 x Ø 80 Ø 68 40 <b>240.00</b> EDL2406WW 6 415 3000 • Warm White 56 x Ø 80 Ø 68 40 <b>240.00</b>						
Material: Aluminum Built-in LED Driver								

FUNCTIONAL LED TILTABLE DOWNLIGHTS								
		<b>New!</b> 3-COLOR TILTABLE DOWNLIGHT		15,000 H 220-240V Operating Voltage SPOT 36° Beam Angle ≥85 CRI Uni-directional	EDL1504TC 4 400 6500 • Daylight 40 x Ø90 Ø 68 40 <b>200.00</b> 3000 • Warm White 4000 • Cool White			
		EDL2504TC 4 400 6500 • Daylight 40 x Ø90 Ø 68 40 <b>200.00</b> 3000 • Warm White 4000 • Cool White						

LED CEILING LAMPS		Wattage	Lumen Output	Color Temperature	Dimmable	Dimensions	Packaging	Suggested Retail Price		
		W	Lm	K	Yes/No	(a x b x c mm)	Pcs./Ctn.	SRP		
		<b>New!</b> Foldable Ceiling Lamp		20,000 H 170-240V Operating Voltage 110° Beam Angle 96 CRI E27	ECL1032DL 32 3200 6500 • Daylight no 195 x 88 x Ø380mm 40 <b>460.00</b>					
				UFO Ceiling Lamp 15,000 H 220V Operating Voltage 120° Beam Angle 80 CRI E27	ECL415DL 15 1200 6000 • Daylight no Ø125 x 75 60 <b>265.00</b> ECL420DL 20 1600 6000 • Daylight no Ø150 x 80 30 <b>370.00</b>					
		LED Circular		15,000 H 165-260V Wide Voltage 180° Beam Angle ≥80 CRI	ECL112R 12 1200 6500 • Daylight no 139 x 87 x 20 20 <b>200.00</b> ECL118R 18 1800 6500 • Daylight no 179 x 127 x 20 20 <b>250.00</b> ECL124R 24 2400 6500 • Daylight no 224 x 170 x 20 20 <b>305.00</b>					
		LED Ceiling Lamp Replacement. In Blister Pack								

FUNCTIONAL LED CEILING LAMPS								
		<b>3-COLOR CEILING LAMP</b> UFO		15,000 H 100-240V Wide Voltage 110° Beam Angle 85 CRI	ECL415TC 15 1500 6500 • Daylight no E27 Ø125 x 65 20 <b>345.00</b> 1400 3000 • Warm White 1500 4000 • Cool White			
		ECL418TC 18 1900 6500 • Daylight no E27 Ø150 x 75 20 <b>465.00</b> 1700 3000 • Warm White 1900 4000 • Cool White						

DECORATIVE LED CEILING LAMPS	Wattage	Lumen Output	Color Temperature	Dimmable	Dimensions	Packaging	Suggested Retail Price
	W	Lm	K	Yes/No	(a x b x c mm)	Pcs./Ctn.	SRP

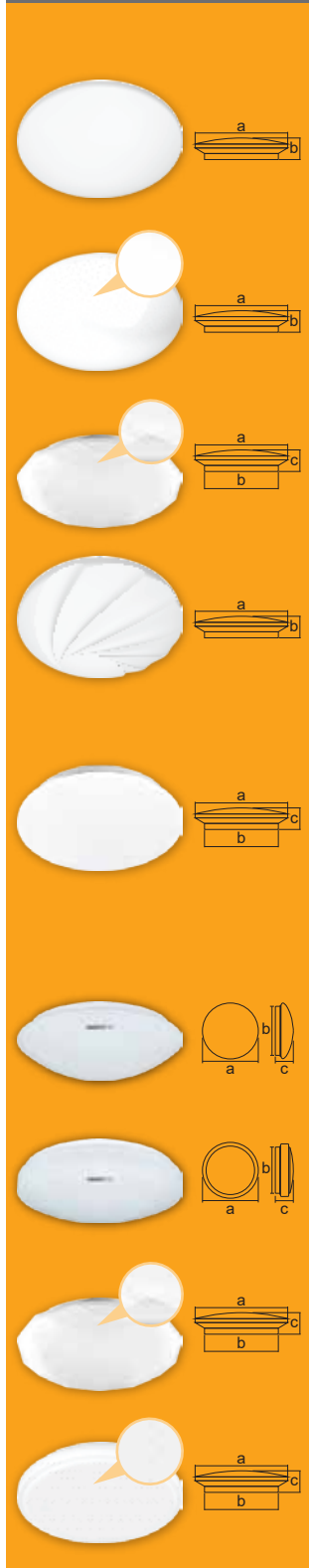

25,000 H  
 180° Beam Angle  
 ≥85 CRI

Classic

Model	Wattage	Lumen Output	Color Temperature	Dimmable	Dimensions	Packaging	Suggested Retail Price
ECL712DL	12	1080	6500 • Daylight	no	235 x 60	5	430.00
ECL718DL	18	1620	6500 • Daylight	no	285 x 60	5	620.00
ECL724DL	24	2040	6500 • Daylight	no	335 x 60	5	700.00

Classic ★ STAR ★

Model	Wattage	Lumen Output	Color Temperature	Dimmable	Dimensions	Packaging	Suggested Retail Price
ECL512DL	12	960	6500 • Daylight	no	235 x 60	5	430.00
ECL518DL	18	1440	6500 • Daylight	no	285 x 60	5	620.00
ECL524DL	24	1920	6500 • Daylight	no	335 x 60	5	700.00

Crystal ★ STAR ★

Model	Wattage	Lumen Output	Color Temperature	Dimmable	Dimensions	Packaging	Suggested Retail Price
ECL912DL	12	960	6500 • Daylight	no	235 x 60	5	430.00
ECL918DL	18	1440	6500 • Daylight	no	285 x 60	5	620.00
ECL924DL	24	1920	6500 • Daylight	no	335 x 60	5	700.00

● SHELL ●

Model	Wattage	Lumen Output	Color Temperature	Dimmable	Dimensions	Packaging	Suggested Retail Price
ECL612DL	12	960	6500 • Daylight	no	225 x 70	5	430.00
ECL618DL	18	1440	6500 • Daylight	no	288 x 70	5	620.00
ECL624DL	24	1920	6500 • Daylight	no	320 x 70	5	700.00

15,000 H  
 180° Beam Angle  
 ≥80 CRI

Classic

Model	Wattage	Lumen Output	Color Temperature	Dimmable	Dimensions	Packaging	Suggested Retail Price
ECL112DL	12	770	6500 • Daylight	no	265 X 230 X 53	10	465.00
ECL118DL	18	1200	6500 • Daylight	no	340 X 300 X 55	10	670.00
ECL124DL	24	1400	6500 • Daylight	no	390 X 350 X 58	10	780.00

20,000 H  
 120° Beam Angle  
 ≥80 CRI

Model	Wattage	Lumen Output	Color Temperature	Dimmable	Dimensions	Packaging	Suggested Retail Price
LCL108WW	8	560	3000 • Warm White	no	215 x 190 x 80	10	530.00
LCL115DL	15	1350	6000 • Daylight	no	345 x 300 x 105	8	830.00
LCL115WW	15	1200	3000 • Warm White	no	345 x 300 x 105	8	830.00
LCL120WW	20	1600	3000 • Warm White	no	390 x 350 x 105	6	980.00

Model	Wattage	Lumen Output	Color Temperature	Dimmable	Dimensions	Packaging	Suggested Retail Price
LCL208DL	8	640	6000 • Daylight	no	215 x 190 x 70	10	530.00
LCL208WW	8	560	3000 • Warm White	no	215 x 190 x 70	10	530.00
LCL220DL	20	1800	6000 • Daylight	no	385 x 350 x 90	6	980.00
LCL220WW	20	1600	3000 • Warm White	no	385 x 350 x 90	6	980.00

Crystal

Model	Wattage	Lumen Output	Color Temperature	Dimmable	Dimensions	Packaging	Suggested Retail Price
ECL312DL	12	770	6500 • Daylight	no	265 x 230 x 53	10	465.00
ECL318DL	18	1200	6500 • Daylight	no	340 x 300 x 55	10	670.00
ECL324DL	24	1400	6500 • Daylight	no	390 x 350 x 58	10	780.00

Pepper

Model	Wattage	Lumen Output	Color Temperature	Dimmable	Dimensions	Packaging	Suggested Retail Price
ECL212DL	12	770	6500 • Daylight	no	265 x 230 x 53	10	465.00
ECL218DL	18	1200	6500 • Daylight	no	340 x 300 x 55	10	670.00
ECL224DL	24	1400	6500 • Daylight	no	390 x 350 x 58	10	780.00

### FUNCTIONAL DECORATIVE LED CEILING LAMPS

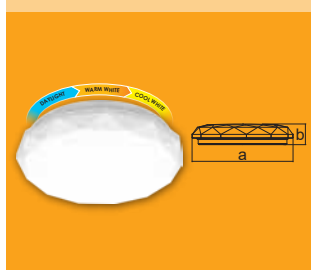

**New!** 3-COLOR CEILING LAMP  
 25,000 H  
 120° Beam Angle  
 ≥80 CRI

Crystal ★ Star ★

Model	Wattage	Lumen Output	Color Temperature	Dimmable	Dimensions	Packaging	Suggested Retail Price
ECL918TC	18	1530 1350 1530	5700 • Daylight 3000 • Warm White 4000 • Cool White	no	∅ 285 x 60	5	750.00
ECL924TC	24	2040 1800 2040	5700 • Daylight 3000 • Warm White 4000 • Cool White	no	∅ 335 x 60	5	940.00

FUNCTIONAL DECORATIVE LED CEILING LAMPS	Wattage	Lumen Output	Color Temperature	Dimmable	Dimensions	Packaging	Suggested Retail Price
	W	Lm	K	Yes/No	(a x b mm)	Pcs./Ctn.	SRP

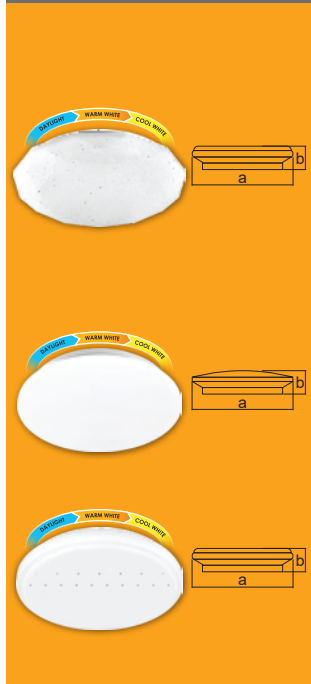

### 3-COLOR CEILING LAMP

			15,000 H	165-260V Wide Voltage	110° Beam Angle	≥80 CRI	
<b>Crystal</b>							
ECL318TC	18	1300 1200 1400	6500 • Daylight 3000 • Warm White 4000 • Cool White	no	340 x 65	10	<b>750.00</b>
ECL324TC	24	1700 1600 1900	6500 • Daylight 3000 • Warm White 4000 • Cool White	no	400 x 65	10	<b>940.00</b>
<b>Classic</b>							
ECL124TC	24	1700 1600 1900	5700 • Daylight 3000 • Warm White 4000 • Cool White	no	390 x 58	10	<b>940.00</b>
<b>Pepper</b>							
ECL224TC	24	1700 1600 1900	5700 • Daylight 3000 • Warm White 4000 • Cool White	no	390 x 58	10	<b>940.00</b>

### LED PANEL LIGHTS

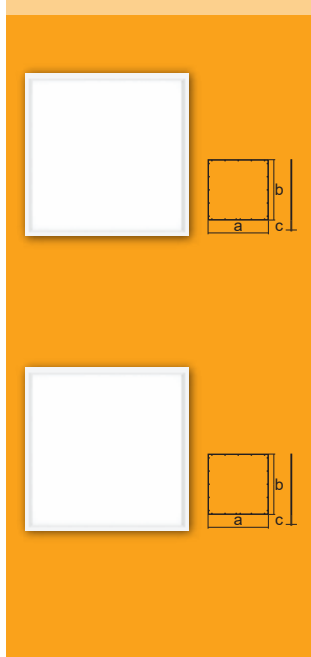

			25,000 H	220-240V Operating Voltage	110° Beam Angle	≥80 CRI	
<b>Backlit Panel Light</b>							
ELU2136DL/1	36	3400	6500 • Daylight	no	600 x 600 x 30	5	<b>1,595.00</b>
ELU2136CW/1	36	3400	5000 • Cool White	no	600 x 600 x 30	5	<b>1,595.00</b>
<b>Panel Light</b>							
ELU3040DL/1	40	3200	6500 • Daylight	no	600 x 600 x 9	5	<b>2,310.00</b>
ELU3040CW/1	40	3200	5000 • Cool White	no	600 x 600 x 9	5	<b>2,310.00</b>
ELU3040DL/2	40	3200	6500 • Daylight	no	300 x 1200 x 9	5	<b>2,310.00</b>
ELU3040CW/2	40	3200	5000 • Cool White	no	300 x 1200 x 9	5	<b>2,310.00</b>



Accessory: Surface Bracket (Recessed to Surface)  
ELU3040DL/1S, ELU3040CW/1S, ELU3040DL/2S, ELU3040CW/2S  
**SRP: 770.00**

### LED SHOP LIGHTS

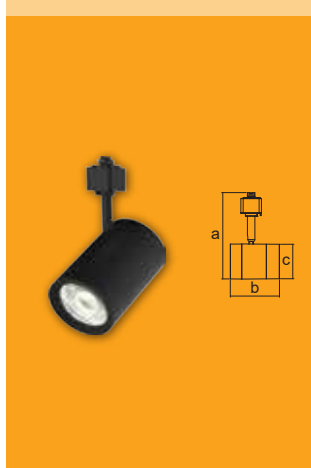

			20,000 H	100-240V Wide Voltage	38° Beam Angle	≥80 CRI	
<b>Track Light</b>							
ETL1108WW	8	600	3000 • Warm White	no	155 x 85 x 60	6	<b>955.00</b>
ETL1115WW	15	1200	3000 • Warm White	no	180 x 135 x 85	6	<b>1,545.00</b>



Accessory: Track Bar for LED Track Light  
ETL11-TB  
Color : Black  
Material : Aluminum  
Dimensions: 1000 x 34 x 17 mm  
**SRP: 535.00**

LED FLOODLIGHTS	Wattage	Lumen Output	Color Temperature	Dimmable	Dimensions	Packaging	Suggested Retail Price
	W	Lm	K	Yes/No	(a x b x c x d mm)	Pcs./Ctn.	SRP

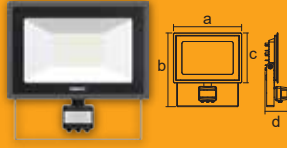

### MOTION SENSOR

Terra Floodlight with Sensor



20,000 H

220-240V

Operating Voltage



110° Beam Angle



≥85 CRI



IP65

Model	Wattage	Lumen Output	Color Temperature	Dimmable	Dimensions	Packing	SRP
EFL84020DL	20	1800	6500 • Daylight	no	138 x 159 x 103 x 53	20	1,000.00
EFL84030DL	30	2610	6500 • Daylight	no	167 x 180 x 122 x 54	20	1,205.00
EFL84050DL	50	4000	6500 • Daylight	no	197 x 194 x 137 x 58	10	1,500.00

\*DOB (Driver on Board) is around 35% lighter than a traditional floodlight

### Terra Floodlight

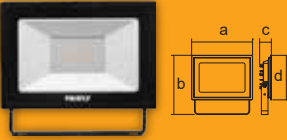

Model	Wattage	Lumen Output	Color Temperature	Dimmable	Dimensions	Packing	SRP
EFL88010DL	10	900	6500 • Daylight	no	115 x 86 x 30	20	385.00
EFL88020DL	20	1800	6500 • Daylight	no	138 x 103 x 30	20	540.00
EFL88030DL	30	2610	6500 • Daylight	no	167 x 122 x 30	20	750.00
EFL88050DL	50	4000	6500 • Daylight	no	198 x 137 x 35	20	1,045.00
EFL88070DL	70	7350	6500 • Daylight	no	245 x 36 x 220	10	1,950.00
EFL88100DL	100	10200	6500 • Daylight	no	290 x 42 x 290	5	2,850.00
EFL88150DL	150	15000	6500 • Daylight	no	350 x 50 x 328	5	4,715.00
EFL88200DL	200	19000	6500 • Daylight	no	395 x 59 x 367	2	6,400.00

\*DOB (Driver on Board) is around 35% lighter than a traditional floodlight



### Regular



20,000 H

100-240V

Wide Voltage



110° Beam Angle



≥80 CRI



IP65

Model	Wattage	Lumen Output	Color Temperature	Dimmable	Dimensions	Packing	SRP
EFL5010DL	10	850	5700 • Daylight	no	105 x 38 x 155	10	450.00
EFL5020DL	20	1900	5700 • Daylight	no	115 x 38 x 165	10	800.00
EFL5030DL	30	2850	5700 • Daylight	no	140 x 38 x 190	10	1,090.00
EFL5050DL	50	4750	5700 • Daylight	no	170 x 38 x 210	10	1,450.00



### Regular



30,000 H

100-240V

Wide Voltage



110° Beam Angle



≥80 CRI



IP65

Model	Wattage	Lumen Output	Color Temperature	Dimmable	Dimensions	Packing	SRP
EFL04100DL	100	9000	5700 • Daylight	no	296 x 60 x 403	1	3,850.00
EFL04150DL	150	16500	5700 • Daylight	no	331 x 60 x 453	1	5,600.00



### Regular



20,000 H

100-240V

Wide Voltage



100° Beam Angle



IP65

Model	Wattage	Lumen Output	Color Temperature	Dimmable	Dimensions	Packing	SRP
EFL3010DL	10	700	6000 • Daylight	no	129 x 180 x 52	10	450.00
EFL3020DL	20	1400	6000 • Daylight	no	149 x 180 x 52	10	700.00
EFL3030DL	30	2100	6000 • Daylight	no	181 x 240 x 62	10	1,050.00
EFL3050DL	50	3500	6000 • Daylight	no	219 x 275 x 66	8	1,400.00

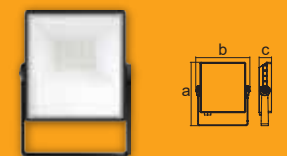

### Pad Floodlight



25,000 H

100-240V

Wide Voltage



110° Beam Angle



≥80 CRI



IP65

Model	Wattage	Lumen Output	Color Temperature	Dimmable	Dimensions	Packing	SRP
EFL3110DL	10	850	6000 • Daylight	no	137 x 117 x 27	30	450.00
EFL3120DL	20	1700	6000 • Daylight	no	158 x 134 x 28	30	700.00
EFL3130DL	30	2550	6000 • Daylight	no	220 x 167 x 35	20	1,050.00
EFL3150DL	50	4250	6000 • Daylight	no	300 x 222 x 37	10	1,400.00
EFL3170DL	70	5950	6000 • Daylight	no	301 x 222 x 38	10	2,100.00



### Tunnel Light



30,000 H

85-265V

Wide Voltage



IP65

Model	Wattage	Lumen Output	Color Temperature	Dimmable	Dimensions	Packing	SRP
EFL2030CW	32	80-120	4000 • Cool White	no	200 x 286	1	1,200.00

## LED PARK LIGHTS

Wattage	Lumen Output	Color Temperature	Dimmable	Lamp Base	Dimensions	Packaging	Suggested Retail Price
W	Lm	K	Yes/No		(a x b x c mm)	Pcs./Ctn.	SRP

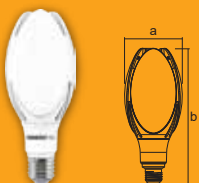

### Park Lamp



25,000 H

176-264V

Wide Voltage



340° Beam Angle



≥80 CRI

Model	Wattage	Lumen Output	Color Temperature	Dimmable	Lamp Base	Dimensions	Packing	SRP
EPL1030DL	30	2700	6500 • Daylight	no	E27	96 x 230	20	780.00

LED STREETLIGHTS	Wattage	Lumen Output	Color Temperature	Dimmable	Dimensions	Packaging	Suggested Retail Price
	W	Lm	K	Yes/No	(a x b mm)	Pcs./Ctn.	SRP

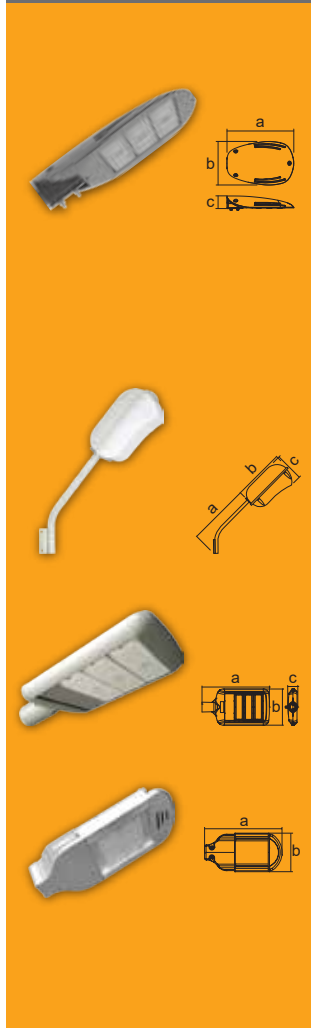

Blade Streetlight	30,000 H	100-240V Wide Voltage	145° Beam Angle	IP65			
ESL5030DL	30	3300	5700 • Daylight	no	175 x 285 x 63	1	2,700.00
ESL5060DL	60	6600	5700 • Daylight	no	293 x 449 x 85	1	5,500.00
ESL5090DL	90	9900	5700 • Daylight	no	293 x 449 x 85	1	6,400.00
ESL5100DL <b>New!</b>	100	11000	5700 • Daylight	no	295 x 460 x 85	1	6,000.00
ESL5120DL	120	13200	5700 • Daylight	no	293 x 449 x 85	1	6,800.00
ESL5150DL <b>New!</b>	150	16000	5700 • Daylight	no	263 x 583 x 91	1	7,000.00

**Arm Hole Dimensions**

Wattage	Min.	Max.
30W	Ø 40 mm	Ø 50 mm
60W, 90W, 120W	Ø 48 mm	Ø 62 mm

Security Light	30,000 H	90-265V Wide Voltage	120° Beam Angle	IP65			
ELSR112DL	12	960	6000 • Daylight	no	285 x 200 x 105	20	930.00

Streetlight	30,000 H	90-305V Wide Voltage	145° Beam Angle	IP65			
ESL4030DL	30	3000	5700 • Daylight	no	354 x 265 x 74	1	5,200.00
ESL4060DL	60	6000	5700 • Daylight	no	424 x 265 x 74	1	8,000.00
ESL4090DL	90	9000	5700 • Daylight	no	494 x 265 x 74	1	10,200.00
ESL4120DL	120	12000	5700 • Daylight	no	494 x 265 x 74	1	12,300.00

Streetlight	30,000 H	85-265V Wide Voltage	120° Beam Angle	IP65		
ESL3035DL	35	5000 • Daylight	no	450 x 200	5	4,000.00

**Arm Hole Dimensions**

Ø 62 mm Mounting Hole Diameter

50 mm Min. Size of Mounting

Compatible with Firefly Lamp Post.

**Accessory: Mounting Adapter**

ESL100/MA

**SRP: 590.00**

LED INDUSTRIAL LIGHTS	Wattage	Lumen Output	Color Temperature	Dimmable	Lamp Base	Dimensions	Packaging	Suggested Retail Price
	W	Lm	K	Yes/No		(a x b x c mm)	Pcs./Ctn.	SRP

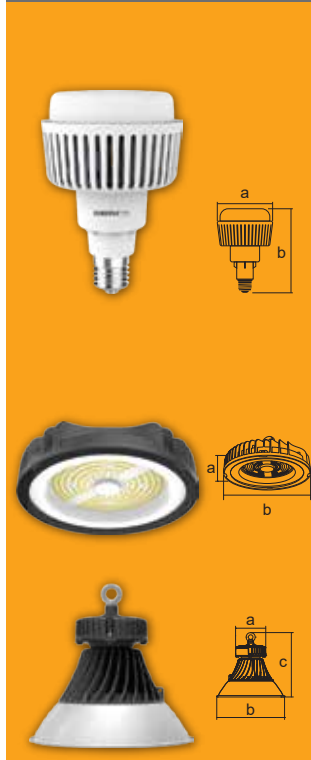

High Power LED Lamp	20,000 H	100-240V Wide Voltage	180° Beam Angle	≥80 CRI				
EHC1040DL	40	4000	6500 • Daylight	no	E27	145 x 218	6	900.00
EHC1060DL	60	5500	6500 • Daylight	no	E27	145 x 218	6	1,300.00
EHC1080DL	80	7500	6500 • Daylight	no	E40	170 x 228	6	1,700.00
EHC1100DL	100	9000	6500 • Daylight	no	E40	190 x 270	6	2,200.00

Reflector for EHC1040DL	Reflector for EHC1060DL	Reflector for EHC1080DL	Reflector for EHC1100DL
EHC1040R	EHC1060R	EHC1080R	EHC1100R
<b>SRP: 150.00</b>	<b>SRP: 150.00</b>	<b>SRP: 150.00</b>	<b>SRP: 150.00</b>

DOB High Bay	35,000 H	220-240V Operating Voltage	110° Beam Angle	≥80 CRI	IP65			
EHB80100DL	100	11000	5700 • Daylight	no	-	220 x 60	1	2,990.00
EHB80150DL	150	16500	5700 • Daylight	no	-	260 x 60	1	4,485.00
EHB80200DL	200	22000	5700 • Daylight	no	-	300 x 60	1	5,425.00

High Bay	30,000 H	100-300V Wide Voltage	90° Beam Angle	IP65				
EHD3090DL	90	9000	5700 • Daylight	no	-	130 x 337 x 279	1	10,040.00
EHD3120DL	120	12000	5700 • Daylight	no	-	150 x 337 x 280	1	10,865.00
EHD3150DL	150	15000	5700 • Daylight	no	-	150 x 337 x 320	1	12,375.00



# FIREFLY<sup>®</sup>

## LIGHTING

### CONVENTIONAL LIGHTING



COMPACT FLUORESCENT	Wattage	Lumen Output	PELP <sup>1</sup> Star Rating	Color Temperature	Lamp Base	Dimensions	Packaging	Suggested Retail Price
	W	Lm	1 to 5	K		(a x b mm)	Pcs./Ctn.	SRP

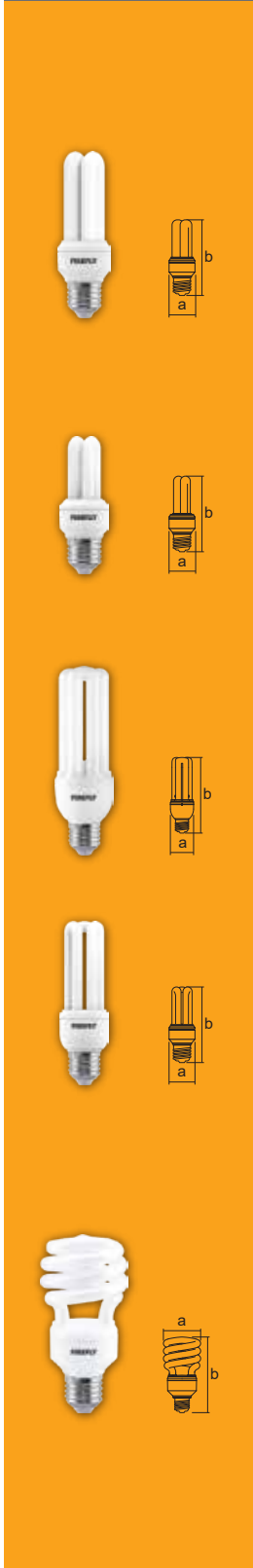

  
8,000 H

**2U**      220-240V Operating Voltage

Model	Wattage	Lumen Output	PELP Star Rating	Color Temperature	Lamp Base	Dimensions	Packaging	Suggested Retail Price
2U03D	3	150	With COE <sup>2</sup>	6500 • Daylight	E27	45 x 111	50/25	<b>79.95</b>
2U05D	5	250	★★★★★	6500 • Daylight	E27	37 x 120	50/25	<b>95.00</b>
2U07D	7	385	★★★★★	6500 • Daylight	E27	37 x 130	50/25	<b>95.00</b>
2U09D	9	495	★★★★★	6500 • Daylight	E27	42 x 150	50/25	<b>95.00</b>
2U11D	11	660	★★★★★	6500 • Daylight	E27	42 x 187	50/25	<b>100.00</b>
2U13D	13	780	★★★★★	6500 • Daylight	E27	42 x 162	50/25	<b>105.00</b>
2U15D	15	930	★★★★★	6500 • Daylight	E27	42 x 175	50/25	<b>105.00</b>

  
8,000 H

**2U Junior**      220-240V Operating Voltage

Model	Wattage	Lumen Output	PELP Star Rating	Color Temperature	Lamp Base	Dimensions	Packaging	Suggested Retail Price
J2U05	5	238	With COE <sup>2</sup>	6500 • Daylight	E27	37 x 105	50/25	<b>79.95</b>
J2U07	7	320	With COE <sup>2</sup>	6500 • Daylight	E27	37 x 110	50/25	<b>79.95</b>
J2U09	9	438	With COE <sup>2</sup>	6500 • Daylight	E27	37 x 121	50/25	<b>84.95</b>

  
8,000 H

**3U**      220-240V Operating Voltage

Model	Wattage	Lumen Output	PELP Star Rating	Color Temperature	Lamp Base	Dimensions	Packaging	Suggested Retail Price
3U18D	18	1170	★★★★★	6500 • Daylight	E27	50 x 167	50/25	<b>130.00</b>
3U20	20	1300	★★★★★	6500 • Daylight	E27	50 x 178	50/25	<b>130.00</b> ↑
3U23	23	1495	★★★★★	6500 • Daylight	E27	50 x 178	50/25	<b>130.00</b> ↑
3U26	26	1690	☆☆☆☆☆	6500 • Daylight	E27	48 x 176	50/25	<b>130.00</b> ↑

  
8,000 H

**3U Junior**      220-240V Operating Voltage





















Model	Wattage	Lumen Output	PELP Star Rating	Color Temperature	Lamp Base	Dimensions	Packaging	Suggested Retail Price
J3U11	11	590	With COE <sup>2</sup>	6500 • Daylight	E27	41 x 114	50/25	<b>119.95</b>
J3U15	15	800	With COE <sup>2</sup>	6500 • Daylight	E27	41 x 139	50/25	<b>119.95</b>

  
8,000 H

**Spiral**      220-240V Operating Voltage

Model	Wattage	Lumen Output	PELP Star Rating	Color Temperature	Lamp Base	Dimensions	Packaging	Suggested Retail Price
3S10	10	570	With COE <sup>2</sup>	6500 • Daylight	E27	45 x 96	50/25	<b>120.00</b>
3S14	14	775	With COE <sup>2</sup>	6500 • Daylight	E27	45 x 100	50/25	<b>125.00</b>
3S20	20	1200	★★★★★	6500 • Daylight	E27	57 x 113	50/25	<b>150.00</b>
3S23	23	1495	★★★★★	6500 • Daylight	E27	60 x 117	50	<b>150.00</b>
3S24	24	1680	With COE <sup>2</sup>	6500 • Daylight	E27	58 x 137	50/25	<b>134.95</b>
3S32	32	2240	★★★★★	6500 • Daylight	E27	72 x 148	20	<b>240.00</b>
3S35	35	2200	With COE <sup>2</sup>	6500 • Daylight	E27	69 x 190	20	<b>220.00</b>
3S42	42	2940	★★★★★	6500 • Daylight	E27	80 x 180	20	<b>300.00</b>
3S45	45	3067	With COE <sup>2</sup>	6500 • Daylight	E27	80 x 215	20	<b>270.00</b>
3S55	55	3572	With COE <sup>2</sup>	6500 • Daylight	E27	80 x 235	20	<b>380.00</b>
3S65	65	4221	Out-of-scope <sup>3</sup>	6500 • Daylight	E27	80 x 240	10	<b>400.00</b>
3S85	85	5354	Out-of-scope <sup>3</sup>	6500 • Daylight	E27	100 x 270	10	<b>600.00</b>
3S105	105	6200	Out-of-scope <sup>3</sup>	6500 • Daylight	E27	110 x 280	4	<b>650.00</b>

Conventional Lighting

INCANDESCENT		Wattage	Lumen Output	Lamp Base	Dimensions	Packaging	Suggested Retail Price	
		W	Lm		(a x b mm)	Pcs./Ctn.	SRP	
 	<b>Standard Lamp</b>		220V Operating Voltage					
	FINS25/F	Frosted	25	160	E27	60 x 105	100/10	23.00
	FINS40/F	Frosted	40	360	E27	60 x 105	100/10	23.00
	FINS50/F	Frosted	50	450	E27	60 x 105	100/10	23.00
	FINS60/F	Frosted	60	660	E27	60 x 105	100/10	23.00
	FINS100/F	Frosted	100	1150	E27	60 x 105	100/10	24.00
	<b>Standard Lamp</b>		110V Operating Voltage					
	FINS25/110	Frosted	25	325	E27	60 x 109	100/10	20.95
	FINS50/110	Frosted	50	650	E27	60 x 109	100/10	20.95
	 	<b>Mushroom Lamp</b>		220V Operating Voltage				
FINM25/F		Soft White	25	325	E27	50 x 91	100/10	24.95
FINM40/F		Soft White	40	520	E27	50 x 91	100/10	24.95
FINM60/F		Soft White	60	780	E27	50 x 91	100/10	24.95
FINM100/F		Soft White	100	1300	E27	61 x 104	100/10	24.95
 	<b>Candle Lamp</b>		220V Operating Voltage					
	FINC25/C14	Clear	25	160	E14	35 x 97	100/10	15.95
	FINC40/C14	Clear	40	520	E14	35 x 97	100/10	15.95
	FINC25/F14	Frosted	25	150	E14	35 x 97	100/10	15.95
	FINC25/C27	Clear	25	160	E27	35 x 97	100/10	15.95
	FINC25/F27	Frosted	25	150	E27	35 x 97	100/10	15.95
	FINC40/F27	Frosted	40	520	E27	35 x 97	100/10	15.95
 	<b>Round Lamp</b>		220V Operating Voltage					
	FINR05/C	Clear	5	65	E27	45 x 73	100/10	14.95
	FINR25/C	Clear	25	325	E27	45 x 73	100/10	14.95
	FINR40/C	Clear	40	520	E27	45 x 73	100/10	14.95
	FINR10/F	Frosted	10	65	E27	45 x 73	100/10	14.95
	FINR25/F	Frosted	25	130	E27	45 x 73	100/10	14.95
	FINR40/F	Frosted	40	325	E27	45 x 73	100/10	14.95
	FINR05/-	R/Y/G/B/O/W	5	65	E27	45 x 73	100/10	14.95
<b>HALOGEN</b>								
 	<b>Dichroic Reflector Halogen</b>		12V Operating Voltage					
	FHDB12/20	MR11	20	360	G4	35 x 35	200/10	29.95
	FHDB12/35	MR11	35	630	G4	35 x 35	200/10	29.95
	FHDA12/20	MR16	20	360	GX5.3	50 x 45	200/10	29.95
	FHDA12/50	MR16	50	900	GX5.3	50 x 45	200/10	29.95
 	<b>Dichroic Reflector Halogen</b>		220V Operating Voltage					
	FHDA220/35	MR16	35	630	GX5.3	50 x 45	200/10	49.95
	FHDA220/50	MR16	50	900	GX5.3	50 x 45	200/10	49.95
 	<b>Linear Halogen (J-type)</b>		220V Operating Voltage					
	FHLA150		150	2400	R7s	12 x 78	500/10	39.95
	FHLB300		300	5400	R7s	12 x 118	500/10	39.95
	FHLB500		500	10000	R7s	12 x 118	500/10	39.95
	FHLC1000		1000	20000	R7s	12 x 189	500/10	69.95
	FHLD1500		1500	33000	R7s	12 x 254	500/10	94.95
 	<b>Peanut Bulb</b>		12V Operating Voltage					
	FHDP12/20		20	360	G4	8 x 21	200/10	24.95
	FHDP12/35		35	630	G4	8 x 21	200/10	24.95
 	<b>Peanut Bulb</b>		220V Operating Voltage					
	FHDP220/35		35	630	G4	13 x 44	200/10	44.95
	FHDP220/50		50	900	G4	13 x 44	200/10	44.95
 	<b>PAR38 Halogen Lamp</b>		220V Operating Voltage					
	FPARFC80	Flood Warm White	80	1440	E27	140 x 132	15	199.95
	FPARFC120	Flood Warm White	120	2160	E27	140 x 132	15	199.95
	FPARSC80	Spot Warm White	80	1440	E27	140 x 132	15	199.95
	FPARSC120	Spot Warm White	120	2160	E27	140 x 132	15	199.95
	FPARR80	Red	80	1440	E27	140 x 132	15	229.95
	FPARY80	Yellow	80	1440	E27	140 x 132	15	229.95
	FPARB80	Blue	80	1440	E27	140 x 132	15	229.95
FPARG80	Green	80	1440	E27	140 x 132	15	229.95	

HIGH INTENSITY DISCHARGE	Wattage	Lumen Output	Color Temperature	Lamp Base	Dimensions	Packaging	Suggested Retail Price
	W	Lm	K		(a x b mm)	Pcs./Ctn.	SRP



**220V**  
Metal Halide Elliptical Lamp Operating Voltage

FHIMH070/E	70	5600	4200 • Cool White	E27	55 x 138	25	<b>699.95</b>
FHIMH150/E	150	12000	4200 • Cool White	E27	55 x 142	25	<b>699.95</b>
FHIMH250/E	250	20000	4500 • Cool White	E40	91 x 226	20	<b>734.95</b>
FHIMH400/E	400	32000	4500 • Cool White	E40	122 x 290	20	<b>734.95</b>
FHIMH1000/E*	1000	93500	4200 • Cool White	E40	120 x 292	12	<b>2,575.00</b>

\*For Tower Light



**220V**  
Metal Halide Tubular Lamp Operating Voltage

FHIMH070/T	70	5500	4500 • Cool White	E27	38 x 156	25	<b>699.95</b>
FHIMH150/T	150	11500	4500 • Cool White	E27	47 x 211	25	<b>699.95</b>
FHIMH250/T	250	20500	4500 • Cool White	E40	47 x 257	25	<b>810.00</b>
FHIMH400/T	400	36000	4500 • Cool White	E40	47 x 283	25	<b>810.00</b>
FHIMH1000/T	1000	85000	4500 • Cool White	E40	66 x 385	20	<b>2,999.95</b>
FHIMH070DL/T	70	4500	6500 • Daylight	E27	38 x 156	25	<b>699.95</b>
FHIMH150DL/T	150	9000	6500 • Daylight	E27	47 x 211	25	<b>699.95</b>
FHIMH250DL/T	250	18000	6500 • Daylight	E40	47 x 257	25	<b>810.00</b>
FHIMH400DL/T	400	28000	6500 • Daylight	E40	47 x 283	25	<b>810.00</b>
FHIMH1000DL/T	1000	82000	6500 • Daylight	E40	66 x 385	20	<b>2,999.95</b>

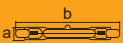
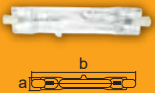

**220V**  
Metal Halide Linear Lamp Operating Voltage

FHIMH070/L	70	5600	4200 • Cool White	R7s	21 x 118	50	<b>699.95</b>
FHIMH150/L	150	12000	4200 • Cool White	R7s	24 x 136	50	<b>699.95</b>



**220V**  
High Pressure Sodium Lamp Operating Voltage

FHIHS070/T	70	6000	2000 • Warm White	E27	38 x 156	25	<b>505.00</b>
FHIHS150/T	150	15000	2000 • Warm White	E27	47 x 211	25	<b>505.00</b>
FHIHS250/T	250	28000	2000 • Warm White	E40	47 x 257	25	<b>630.00</b>
FHIHS400/T	400	48000	2000 • Warm White	E40	47 x 283	25	<b>630.00</b>



**220V**  
Mercury Lamp Operating Voltage

FHIBM160/E	160	3100	3600 • Warm White	E27	76 x 177	25	<b>139.95</b>
FHIBM250/E27	250	5500	3600 • Warm White	E27	91 x 232	20	<b>220.00</b>
FHIBM250/E40	250	5500	3600 • Warm White	E40	91 x 232	20	<b>240.00</b>
FHIBM500/E	500	11000	3600 • Warm White	E40	122 x 287	10	<b>360.00</b>

Product Description	Wattage	PKG.	Suggested Retail Price	Product Description	Wattage	PKG.	Suggested Retail Price
	W	Pcs./Ctn.	SRP	Item Code	W	Pcs./Ctn.	SRP



**220V**  
Metal Halide Ballast Operating Voltage

FHIMHB070	70	6	<b>855.00</b>
FHIMHB150	150	6	<b>1,210.00</b>
FHIMHB250	250	6	<b>1,550.00</b>
FHIMHB400	400	6	<b>1,955.00</b>
FHIMHB1000	1000	2	<b>6,450.00</b>



**220V**  
Metal Halide / HPS Ignitor Operating Voltage

FHIMHI70/400	70 - 400	100/20	<b>379.95</b>
FHIMHI1000	1000	100/10	<b>799.95</b>



**220V**  
High Pressure Sodium Ballast Operating Voltage

FHIHSB070	70	6	<b>855.00</b>
FHIHSB150	150	6	<b>1,195.00</b>
FHIHSB250	250	6	<b>1,590.00</b>
FHIHSB400	400	6	<b>2,010.00</b>



**220V**  
Metal Halide / HPS Capacitor Operating Voltage

FHIMHC070	12 uF	70	100	<b>185.00</b>
FHIMHC150/250	16 uF	150/250	100	<b>249.95</b>
FHIMHC400	25 uF	400	100	<b>420.00</b>
FHIMHC1000	63 uF	1000	100	<b>1,099.95</b>

FLUORESCENT TUBE	Wattage		Lumen Output		PELP <sup>1</sup> Star Rating	Color Temperature	Lamp Base	Dimensions	Packaging	Suggested Retail Price
	W	Lm	1 to 5	K		(a x b mm)	Pcs./Ctn.	SRP		

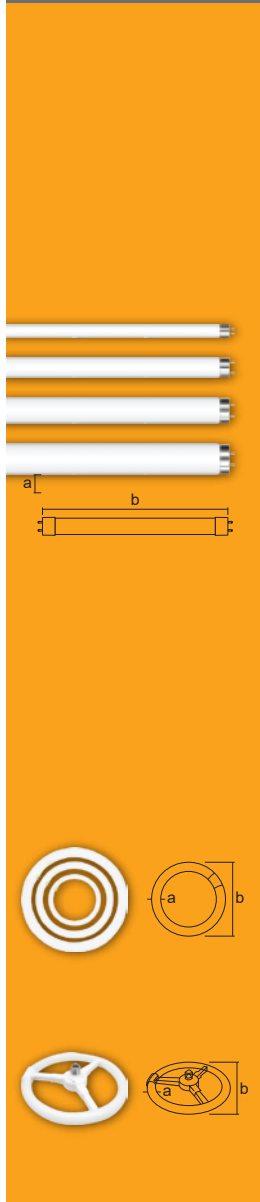

 **220V Operating Voltage**

**Straight FL Tube**      **10,000 H**

FS08/T5D	T5	8	440	With COE <sup>2</sup>	6500 • Daylight	G5	15.9 x 300	25	<b>60.00</b>
FS08/T5C	T5	8	480	With COE <sup>2</sup>	4000 • Cool White	G5	15.9 x 300	25	<b>47.00</b>
FS08/T5W	T5	8	480	With COE <sup>2</sup>	2700 • Warm White	G5	15.9 x 300	25	<b>60.00</b>
FS14/T5D	T5	14	980	With COE <sup>2</sup>	6500 • Daylight	G5	15.9 x 550	25	<b>77.00</b>
FS14/T5C	T5	14	980	With COE <sup>2</sup>	4000 • Cool White	G5	15.9 x 550	25	<b>63.00</b>
FS14/T5W	T5	14	1008	With COE <sup>2</sup>	2700 • Warm White	G5	15.9 x 550	25	<b>77.00</b>
FS21/T5D	T5	21	1470	With COE <sup>2</sup>	6500 • Daylight	G5	15.9 x 850	25	<b>88.00</b>
FS21/T5C	T5	21	1260	With COE <sup>2</sup>	4000 • Cool White	G5	15.9 x 850	25	<b>71.00</b>
FS21/T5W	T5	21	1575	With COE <sup>2</sup>	2700 • Warm White	G5	15.9 x 850	25	<b>88.00</b>
FS28/T5D	T5	28	1680	With COE <sup>2</sup>	6500 • Daylight	G5	15.9 x 1150	25	<b>94.00</b>
FS28/T5C	T5	28	1680	With COE <sup>2</sup>	4000 • Cool White	G5	15.9 x 1150	25	<b>77.00</b>
FS28/T5W	T5	28	1820	With COE <sup>2</sup>	2700 • Warm White	G5	15.9 x 1150	25	<b>94.00</b>
FS10/T8D	T8	10	600	With COE <sup>2</sup>	6500 • Daylight	G13	25.4 x 330	25	<b>39.95</b>
FS18/T8D	T8	18	990	☆☆☆☆☆	6500 • Daylight	G13	25.4 x 590	25	<b>66.00</b>
FS18/T8W	T8	18	1080	With COE <sup>2</sup>	2700 • Warm White	G13	25.4 x 590	25	<b>59.95</b>
FS18/T8C	T8	18	1080	With COE <sup>2</sup>	4000 • Cool White	G13	25.4 x 590	25	<b>59.95</b>
FS36/T8D	T8	36	2320	☆☆☆☆☆	6500 • Daylight	G13	25.4 x 1200	25	<b>72.00</b>
FS36/T8W	T8	36	2520	With COE <sup>2</sup>	2700 • Warm White	G13	25.4 x 1200	25	<b>64.95</b>
FS36/T8C	T8	36	2520	With COE <sup>2</sup>	4000 • Cool White	G13	25.4 x 1200	25	<b>64.95</b>
FS20/T10D	T10	20	1200	With COE <sup>2</sup>	6500 • Daylight	G13	31.75 x 590	25	<b>54.95</b>
FS40/T10D	T10	40	2600	With COE <sup>2</sup>	6500 • Daylight	G13	31.75 x 1200	25	<b>59.95</b>
FS20/T12D*	T12	20	1100	With COE <sup>2</sup>	6500 • Daylight	G13	38.1 x 590	25	<b>85.00</b>
FS40/T12D*	T12	40	2600	With COE <sup>2</sup>	6500 • Daylight	G13	38.1 x 1200	25	<b>105.00</b>

\*Not for electronic ballast use.

 **220V Operating Voltage**





**T9 Circular FL Tube**      **10,000 H**





FC22/T9	22	990	With COE <sup>2</sup>	6500 • Daylight	G10Q	28.6 x 215	20	<b>130.00</b>
FC32/T9	32	1600	With COE <sup>2</sup>	6500 • Daylight	G10Q	28.6 x 310	20	<b>140.00</b>
FC40/T9	40	2600	With COE <sup>2</sup>	6500 • Daylight	G10Q	28.6 x 400	20	<b>165.00</b>































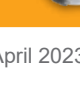



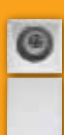











 **220V Operating Voltage**

**Circular Lamp Set with Electronic Ballast**      **10,000 H**

FECLB22	22	990	With COE <sup>2</sup>	6500 • Daylight	E27	28.6 x 215	20	<b>330.00</b>
FECLB32	32	1600	With COE <sup>2</sup>	6500 • Daylight	E27	28.6 x 310	20	<b>400.00</b>

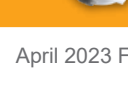
Product Description	Wattage	Lamp Base	PKG.	Suggested Retail Price	Product Description	PKG.	Suggested Retail Price			
	W		Pcs./Ctn.	SRP		Pcs./Ctn.	SRP			
 <p><b>Electronic Ballast for Circular Lamp with Holder</b></p> <p style="text-align: right;"><b>220V Operating Voltage</b></p>	FECHA22	22	E27	20	<b>165.00</b>	 <p><b>Premium Magnetic Ballast for Straight FL</b></p> <p style="text-align: right;"><b>220V Operating Voltage</b></p>	FCGFMB20/220 20W	20/5	<b>180.00</b>	
	FECHA32	32	E27	20	<b>200.00</b>		FCGFMB40/220 40W	20/5	<b>180.00</b>	
	 <p><b>Starter with Condenser</b></p> <p style="text-align: right;"><b>220V Operating Voltage</b></p>	FSU	4-65	N/A	500/25		<b>17.00 ↑</b>	 <p><b>Electronic Ballast for Straight FL</b></p> <p style="text-align: right;"><b>220V Operating Voltage</b></p>	FSEB1x14/220A	T5
							FSEB2x14/220A	T5	50	<b>400.00</b>
							FSEB2x28/220A	T5	50	<b>520.00</b>
							FSEB1x18/220A	T8	50	<b>255.00</b>
							FSEB2x18/220A	T8	80	<b>305.00</b>
							FSEB1x36/220A	T8	50	<b>275.00</b>
							FSEB2x36/220A	T8	60	<b>390.00</b>

LIGHTING & ELECTRICAL DEVICES		PKG.	Suggested Retail Price		LIGHTING & ELECTRICAL DEVICES		PKG.	Suggested Retail Price		
		Pcs./Ctn.	SRP				Pcs./Ctn.	SRP		
	<b>New!</b> <b>DUSK to DAWN</b>					<b>E27 Ceiling Receptacle 3 1/2"</b> 4A • 250V				
	<b>Photosensor Switch - Surface Type</b> Maximum Load : 1100 Watts Rated Current : 6A Input Voltage : 180-240V AC IP Rating : IP44	FEDPS06	100	<b>170.00</b>		FEDCRC103	Cream	200/10	<b>29.00</b>	
	<b>Streetlight Photosensor Switch</b> Maximum Load : 1800 Watts Rated Current : 10A Input Voltage : 220-240V AC IP Rating : IP65	FEDPS10	50	<b>480.00</b>			<b>E27 Ceiling Receptacle 4 1/4"</b> 4A • 250V			
		FEDCRC104	120/10	<b>35.00</b>			FEDCRW103	White	200/10	<b>29.00</b>
		FEDCRC104	120/10	<b>35.00</b>			<b>E27 Ceiling Receptacle 4 1/4", Porcelain</b> 4A • 250V			
		FEDCRW204	60/10	<b>75.00</b>						
	<b>New!</b> <b>MOTION SENSOR</b>					<b>Ceramic Receptacle</b> For E27 / E40 Lamp Base				
	<b>Surface Type Switch</b> Maximum Load : 300 Watts Detection Angle : 360° Detection Range : 5M Input Voltage : 220-240V AC 50/60Hz IP Rating : IP20	FEDSS100	100	<b>370.00</b>		FEDCER101/E27H		400	<b>30.00</b>	
						<b>Flexible Swing-Type Plug</b> 10A • 250V				
	<b>Surface Type Switch</b> Maximum Load : 800 Watts Detection Angle : 360° Detection Range : 5M Input Voltage : 220-240V AC 50/60Hz IP Rating : IP20	FEDSS800	100	<b>490.00</b>		FEDPL102	White	200/20	<b>25.95</b>	
						<b>Deluxe Plug with Transparent Button</b> 10A • 250V				
	<b>Recessed Type Switch</b> Maximum Load : 1200 Watts Detection Angle : 360° Detection Range : 5M Input Voltage : 220-240V AC 50/60Hz IP Rating : IP20	FEDSS1200	50	<b>470.00</b>		FEDPL107		100/20	<b>33.95</b>	
						<b>Heavy Duty Plug with Ground</b> 20A • 250V				
	<b>Recessed Type Switch</b> Maximum Load : 1200 Watts Detection Angle : 180° Input Voltage : 220-240V AC 50/60Hz IP Rating : IP44	FEDTS1200	50	<b>610.00</b>		FEDPL108		200/20	<b>47.95</b>	
	<b>GU10 Lampholder</b> 2A • 250V	FELH105*	White	500	<b>36.00</b>		<b>Dimmer 250 Watts</b> 10A • 250V			
	*Pack in 2's				ECSDM101	1M Cord	100/20	<b>179.95</b>		
	<b>E27 Ceiling Receptacle 2 1/4"</b> 4A • 250V	FEDCRC102	Cream	200/10	<b>25.00</b>		<b>Keyless Socket</b> 4A • 250V			
		FEDCRW102	White	200/10	<b>25.00</b>		FELH101		200/20	<b>28.00</b> ↑
					<b>E27 Push Through Socket</b> 4A • 250V					
					FELH102		200/20	<b>45.00</b> ↑		
					<b>Pull Chain Socket w/ Flat Pin Outlet</b> 4A • 250V					
					FELH103		200/20	<b>58.00</b>		
					<b>Weatherproof Socket</b> 4A • 250V					
					FELH104		200/20	<b>29.00</b> ↑		

DOWNLIGHTS	Cut-out Size	PKG.	Suggested Retail Price	DOWNLIGHTS	PKG.	Suggested Retail Price			
	mm	Pcs./Ctn.	SRP		Pcs./Ctn.	SRP			
<b>Vertical Downlight Recessed Type</b>				<b>Vertical Downlight Recessed Type with Full Frosted Glass</b>					
	FD101GM3.5	Gun Metal	100/10	<b>115.00</b>		FD341WH4	1 x E27	40	<b>210.00</b>
	FD101SG3.5	Satin Gold	100/10	<b>115.00</b>		FD341WH5	1 x E27	30	<b>249.95</b>
	FD101SN3.5	Satin Nickel	100/10	<b>115.00</b>	<b>Vertical Downlight Surface Type</b>				
	FD101CP3.5	Copper	100/10	<b>115.00</b>		FLESSDL4	1 x E27	30	<b>195.00</b>
	FD101MH3.5	Mahogany	100/10	<b>115.00</b>		FLESSDL5	1 x E27	30	<b>265.00</b>
<b>Vertical Downlight Recessed Type with Partial Frosted Glass</b>					FLESSDL6	1 x E27	18	<b>290.00</b>	
	FD301WH3	1 x E27	50	<b>150.00</b>	<b>Vertical Downlight Surface Type - Aluminum For Outdoor Use</b>				
	FD301WH4	1 x E27	40	<b>250.00</b>		FLESSDL4-A	1 x E27	30	<b>270.00</b>
	FD301WH5	1 x E27	30	<b>265.00</b>		FLESSDL6-A	1 x E27	18	<b>390.00</b>
	FD301WH6	1 x E27	24	<b>330.00</b>	<b>Vertical Downlight Surface Type with Glass Cover</b>				
<b>Vertical Downlight Recessed Type for Pin Light</b>					FD161WH4	1 x E27	30	<b>250.00</b>	
	FLESDB3.5	1 x G24D-2	100/10	<b>93.00</b>		FD161BL4	1 x E27	30	<b>250.00</b>
	FLESDB4	1 x G24D-2	100/10	<b>110.00</b>		FD161WH6	1 x E27	18	<b>315.00</b>
	FLESDB6	1 x G24D-2	100/10	<b>125.00</b>		FD161BL6	1 x E27	18	<b>315.00</b>
<b>Vertical Downlight Recessed Type</b>				<b>Square Vertical Downlight Recessed Type</b>					
	FLESDB4/E27	1 x E27	100	<b>110.00</b>		FD401WH4	1 x E27	40	<b>249.95</b>
	FLESDB6/E27	1 x E27	100/10	<b>125.00</b>	<b>Square Vertical Downlight Recessed Type with Partial Frosted Glass</b>				
	FLESDB7/E27	1 x E27	100	<b>135.00</b>		FD421WH3.5	1 x E27	50	<b>124.95</b>
<b>Non Glossy Reflector</b>					FD421WH4	1 x E27	40	<b>199.95</b>	
	FLESDB3.5/E27B	1 x E27	100/10	<b>110.00</b>	<b>Square Vertical Downlight Surface Type</b>				
	FLESDB4/E27B	1 x E27	100/10	<b>130.00</b>		FD411WH4	1 x E27	25	<b>300.00</b>
	FLESDB6/E27B	1 x E27	100/10	<b>140.00</b>		FD411BL4	1 x E27	25	<b>300.00</b>
	FD101WH8	1 x E27	50/5	<b>210.00</b>		FD411WH6	1 x E27	18	<b>340.00</b>
<b>Glossy Reflector</b>					FD411BL6	1 x E27	18	<b>340.00</b>	
<b>Fixed MR16 Downlight Fixture with GU10 Lampholder</b>				<b>Horizontal Downlight Recessed Type</b>					
	FD201WH	Ø 60 mm	100	<b>230.00</b>		FLESHDLA5/1	1 x E27	30	<b>164.95</b>
<b>Tilttable MR16 Downlight Fixture with GU10 Lampholder</b>					FLESHDLA5/2	2 x E27	30	<b>164.95</b>	
	FD202WH	Ø 70 mm	100	<b>255.00</b>		FLESHDLA6/2	2 x E27	30	<b>174.95</b>
	FD203WH	Ø 70 mm	50	<b>325.00</b>		FD351WH7	2 x E27	15	<b>279.95</b>
<b>Low Glare MR16 Downlight Fixture with GU10 Lampholder</b>					FD351WH8	2 x E27	12	<b>320.00</b>	
	FD204WH	Ø 76 mm	50	<b>190.00</b>	<b>Horizontal Downlight Recessed Type with Partial Frosted Glass</b>				
	FD205WH	Ø 76 mm	50	<b>315.00</b>		FD361WH4	1 x E27	24	<b>230.00</b>
<b>IP44 MR16 Downlight Fixture with GU10 Lampholder</b>				<b>Horizontal Downlight Recessed Type with Gear Box for Pin Light</b>					
	FD206WH	Ø 60 mm	50	<b>445.00</b>		FD361WH5	2 x E27	30	<b>270.00</b>
	FD207WH	Ø 60 mm	50	<b>470.00</b>		FD361WH6	2 x E27	24	<b>330.00</b>
<b>Twin MR16 Downlight Fixture with GU10 Lampholder</b>					FD361WH8	2 x E27	12	<b>380.00</b>	
	FD208WH	170 x 80 mm	30	<b>660.00</b>	<b>Horizontal Downlight Recessed Type with Gear Box for Pin Light</b>				
					FLES DLC6/2	2-Lamp	20	<b>349.95</b>	

DOWNLIGHTS				INDUSTRIAL LOW BAY			
				Size	PKG.	Suggested Retail Price	
				In.	Pcs./Ctn.	SRP	
	Horizontal Downlight Recessed Type with Glass Cover						
	FLESHDLB5/1	1 x E27	30	<b>229.95</b>			
	FLESHDLB5/2	2 x E27	30	<b>229.95</b>			
	FLESHDLB6/2	2 x E27	20	<b>269.95</b>			
	FD371WH7	2 x E27	100	<b>299.95</b>			
	FD371WH8	2 x E27	100	<b>330.00</b>			
	Square Horizontal Downlight Recessed Type with Full Frosted Glass						
	FD471WH3	1 x E27	20	<b>210.00</b>			
	FD476WH4	2 x E27	20	<b>235.00</b>			
	FD476WH6	2 x E27	20	<b>359.95</b>			
	Square Horizontal Downlight Recessed Type with Partial Frosted Glass & Groove						
	FD456WH4	2 x E27	20	<b>240.00</b>			
	FD456WH5	2 x E27	20	<b>279.95</b>			
	FD456WH6	2 x E27	20	<b>380.00</b>			
	FD456WH9	2 x E27	12	<b>420.00</b>			
	FD456WH4/1	1 x E27	20	<b>229.95</b>			
	FD456WH6/1	1 x E27	20	<b>359.95</b>			
	FD477WH6	2 x E27	20	<b>400.00</b>			
	FD477WH9	2 x E27	12	<b>399.95</b>			
	Halogen Dichroic Recessed Fixture - Fixed						
FLHD11/WF	1 x G4	100	<b>54.00</b>				
FLHD16/WF	1 x GX5.3	100	<b>50.00</b>				
Halogen Dichroic Recessed Fixture - Revolving							
FLHD11/WR	1 x G4	100	<b>48.00</b>				
FLHD16/WR	1 x GX5.3	100	<b>85.00</b>				
Vertical Recessed Type MR16 Fixed Recessed Lamp							
FD641WH4	1 x GX5.3	100	<b>99.95</b>				
Halogen Multi-directional Recessed Spotlight							
FLHD16/MD	1 x GX5.3	100	<b>199.95</b>				
Square Recessed Type MR16 Fixed							
FD651WH3	1 x GX5.3	100	<b>83.00</b>				
Square Recessed Type MR16 Fixed Recessed Lamp							
FD672WH4	1 x GX5.3	100	<b>109.95</b>				
Square Recessed Type MR16 Uni-directional							
FD652WH4	1 x GX5.3	100	<b>140.00</b>				
Square Recessed Type MR16 Uni-directional with Frosted Curved Glass							
FD681WH4	1 x GX5.3	100	<b>119.95</b>				
Square Recessed Type MR16 Multi-directional							
FD653WH4.5	1 x GX5.3	50	<b>199.95</b>				
Square Recessed Type MR16 Fixed Recessed Lamp							
FD671WH3.5	White	50	<b>119.95</b>				
FD671SV3.5	Silver	100	<b>130.00</b>				
	Lampholder Hook Type						
	FLHI945	E27	50	<b>220.00</b>			
	FLHI945/E40	E40	50	<b>330.00</b>			
	Low Bay Reflector Bracket for Blended Mercury / CFL						
	FLHI915	E27	16"	20	<b>550.00</b>		
	Low Bay Reflector Bracket for Blended Mercury / CFL						
	FLHI925	E27	4.72"	50	<b>199.95</b>		
	FLHI925/E40	E40		50	<b>199.95</b>		
	Low Bay Aluminum Reflector for Blended Mercury / CFL						
	FLHI356/16	45 to 55W	16"	20	<b>330.00</b>		
	FLHI356/14	26W	14"	20	<b>285.00</b>		
	FLHI356/12	26W	12"	20	<b>275.00</b>		
	FLHI356/10	26W	10"	20	<b>220.00</b>		
	<b>INDUSTRIAL HIGH BAY</b>						
		High Bay Aluminum Gear Box for MH / HPS Die-cast Aluminum					
FLHI225		Gray	E40	4	<b>1,870.00</b> ↑		
FLHI215		Gray	E27	4	<b>1,320.00</b> ↑		
High Bay Polycarbonate Reflector for MH / HPS							
FLHI350/21		400W MH	21"	5	<b>2,310.00</b>		
FLHI350/19		250W MH	19"	10	<b>2,145.00</b>		
FLHI350/16		70/150W MH	16"	10	<b>1,210.00</b>		
Polycarbonate Cover							
FLHI970/21			21"	20	<b>1,320.00</b>		
FLHI970/19			19"	25	<b>1,155.00</b>		
FLHI970/16			16"	25	<b>825.00</b>		
High Bay Aluminum Reflector for MH / HPS							
FLHI326/19		250/400W MH	19"	10	<b>1,320.00</b>		
Glass Cover							
FLHI977/19			19"	10	<b>880.00</b>		
High Bay Sand Blasted Reflector for MH / HPS							
FLHI316/16	70/150W MH	16"	10	<b>990.00</b>			
Glass Cover							
FLHI977/16		16"	1	<b>579.95</b>			
Iron Hook for FLHI225 & FLHI215 Gear Box							
FLHI935			300	<b>110.00</b>			

BOX TYPE LUMINAIRE	Wattage		Operating Voltage	Dimensions	Packaging	Suggested Retail Price
	W	V	V	(a x b x c mm)	Pcs./Ctn.	SRP

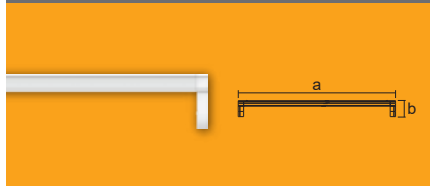

Box Type Luminaire for LED T8 Tube (Single-Ended)

FLLBT210600	T8	-	-	625 x 180 x 150	40	<b>77.00</b>
FLLBT211200	T8	-	-	1235 x 180 x 150	40	<b>90.00</b>

### OPEN TYPE

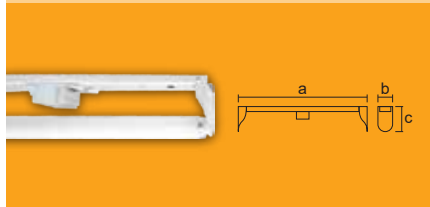

Open Type Fixture Rotary Type

FSV1/10	T8	1 x 10W	12V	350 x 48 x 90	25	<b>150.00</b>
FSV1/20	T8	1 x 20W	12V	610 x 48 x 90	25	<b>175.00</b>
FSV1/40	T8	1 x 40W	12V	1220 x 48 x 90	25	<b>185.00</b>

Fixture with Ballast & Starter

### ELECTRONIC

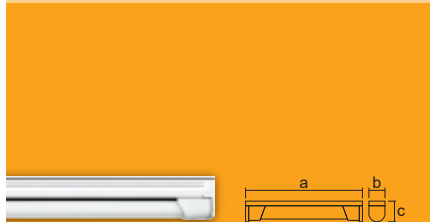

T5 Electronic Fluorescent Lamp

FLT5/CE1X8DL	T5	1 x 8W	220V	312 x 22.2 x 35	25	<b>200.00</b>
FLT5/CE1X8CW	T5	1 x 8W	220V	312 x 22.2 x 35	25	<b>160.00</b>
FLT5/CE1X8WW	T5	1 x 8W	220V	312 x 22.2 x 35	25	<b>200.00</b>
FLT5/CE1X14DL	T5	1 x 14W	220V	573 x 22.2 x 35	25	<b>260.00</b>
FLT5/CE1X14CW	T5	1 x 14W	220V	573 x 22.2 x 35	25	<b>200.00</b>
FLT5/CE1X14WW	T5	1 x 14W	220V	573 x 22.2 x 35	25	<b>260.00</b>
FLT5/CE1X21DL	T5	1 x 21W	220V	873 x 22.2 x 35	25	<b>300.00</b>
FLT5/CE1X21CW	T5	1 x 21W	220V	873 x 22.2 x 35	25	<b>250.00</b>
FLT5/CE1X21WW	T5	1 x 21W	220V	873 x 22.2 x 35	25	<b>300.00</b>
FLT5/CE1X28DL	T5	1 x 28W	220V	1173 x 22.2 x 35	25	<b>370.00</b>
FLT5/CE1X28CW	T5	1 x 28W	220V	1173 x 22.2 x 35	25	<b>290.00</b>
FLT5/CE1X28WW	T5	1 x 28W	220V	1173 x 22.2 x 35	25	<b>370.00</b>

Slim Type Electronic



FEWL5114	T5	1 x 14W	220V	610 x 25 x 40	20	<b>479.95</b>
FEWL5128	T5	1 x 28W	220V	1210 x 25 x 40	20	<b>699.95</b>
FEWL8118	T8	1 x 18W	220V	670 x 35 x 40	20	<b>449.95</b>
FEWL8136	T8	1 x 36W	220V	1280 x 35 x 40	20	<b>649.95</b>

Wide Type Electronic



FEWL8210	T8	1 x 10W	220V	380 x 105 x 40	20	<b>399.95</b>
FEWL8218	T8	1 x 18W	220V	640 x 105 x 40	20	<b>519.95</b>
FEWL8318/2	T8	2 x 18W	220V	640 x 115 x 40	20	<b>829.95</b>
FEWL8336/2	T8	2 x 36W	220V	1250 x 115 x 40	20	<b>1,249.95</b>

### 3P FLUORESCENT WATER-PROOF LUMINAIRE

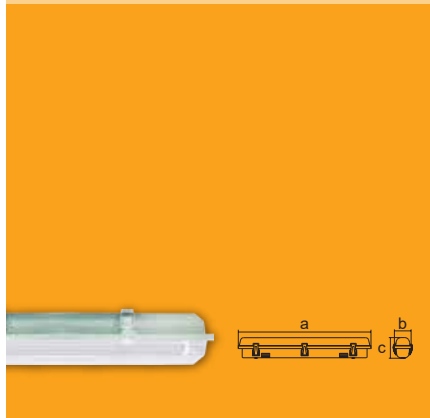

For Straight FL Tube Fixture with Electronic Ballast, IP65

FLSFWP1X14A	T5	1 x 14W	220-240V	610 x 70 x 79	20	<b>670.00</b>
FLSFWP2X14A	T5	2 x 14W	220-240V	610 x 106 x 79	16	<b>820.00</b>
FLSFWP1X28A	T5	1 x 28W	220-240V	1210 x 70 x 79	12	<b>890.00</b>
FLSFWP2X28A	T5	2 x 28W	220-240V	1210 x 106 x 79	8	<b>1,180.00</b>
FLSFWP1X20A	T8	1 x 20W	220-240V	655 x 91 x 94	6	<b>665.00</b>
FLSFWP2X20A	T8	2 x 20W	220-240V	655 x 138 x 94	6	<b>815.00</b>
FLSFWP1X40A	T8	1 x 40W	220-240V	1268 x 91 x 94	6	<b>990.00</b>
FLSFWP2X40A	T8	2 x 40W	220-240V	1268 x 138 x 94	4	<b>1,230.00</b>

For Straight T8 FL Tube, IP65 - Fixture Only

FLSFWP1X20A/0	T8	1 x 20W		655 x 91 x 94	10	<b>490.00</b>
FLSFWP2X20A/0	T8	2 x 20W		655 x 138 x 94	8	<b>620.00</b>
FLSFWP1X40A/0	T8	1 x 40W		1268 x 91 x 94	6	<b>760.00</b>
FLSFWP2X40A/0	T8	2 x 40W		1268 x 138 x 94	4	<b>890.00</b>

Optional:

 <p>Stainless Steel Clip for T5 Waterproof Luminaire FLSFWP-SSC/T5 • 6 Pcs. for 14 W • 10 Pcs. for 28 W <b>SRP: 16.00</b></p>	 <p>Stainless Steel Clip for T8 Waterproof Luminaire FLSFWP-SSC/T8 • 6 Pcs. for 20W • 10 Pcs. for 40W <b>SRP: 22.00</b></p>
--	--









Conventional Lighting

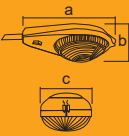

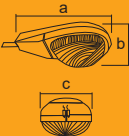
FLOODLIGHT		Wattage	Lamp Base	Dimensions	Packaging	Suggested Retail Price
		W		(a x b x c mm)	Pcs./Ctn.	SRP
		220V Operating Voltage				<b>IP65</b> IP Rating
		<b>Compact Fluorescent</b>				
FLCF111	2 x 30W	E27	280 x 350 x 100	1	<b>1,219.95</b>	
<i>Fixture Only</i>						
		220V Operating Voltage				<b>IP65</b> IP Rating
		<b>Compact Fluorescent</b>				
FLCF113	3 x 30W	E27	430 x 550 x 140	1	<b>2,059.95</b>	
<i>Fixture Only</i>						
		220V Operating Voltage				<b>IP65</b> IP Rating
		<b>Halogen Floodlight with Lamp</b>				
FHFF150	150	R7s	138 x 170 x 78	30	<b>199.95</b>	
FHFF300	300	R7s	185 x 245 x 113	20	<b>254.95</b>	
FHFF500	500	R7s	185 x 245 x 113	20	<b>254.95</b>	
FHFF1000	1000	R7s	275 x 245 x 134	12	<b>629.95</b>	
FHFF1500	1500	R7s	345 x 368 x 168	6	<b>1,099.95</b>	
		220V Operating Voltage				<b>IP65</b> IP Rating
		<b>Neptune Series</b> Metal Halide Floodlight Tubular Type				
FLHI111/S/070	70	E27	275 x 385 x 102	1	<b>2,920.00</b>	
FLHI111/S/150	150	E27	275 x 385 x 102	1	<b>3,135.00</b>	
<i>Includes Ballast, Ignitor, Capacitor Only</i>						
		220V Operating Voltage				<b>IP65</b> IP Rating
		<b>Metal Halide Tubular Type</b>				
FLMHT250	250	E40	232 x 435 x 88	1	<b>4,510.00</b>	
FLMHT400	400	E40	232 x 435 x 88	1	<b>5,170.00</b>	
<i>Includes Ballast, Ignitor, Capacitor Only</i>						
		220V Operating Voltage				<b>IP65</b> IP Rating
		<b>Metal Halide Linear Type</b>				
FLMHL070	70	R7s	412 x 505 x 138	3	<b>2,400.00</b>	
FLMHL150	150	R7s	412 x 505 x 138	1	<b>3,300.00</b>	
<i>Includes Ballast, Ignitor, Capacitor Only</i>						
		220V Operating Voltage				<b>IP65</b> IP Rating
		<b>Venus Series</b> Metal Halide Floodlight Tubular Type				
FLHI121/S/250	250	E40	428 x 505 x 144	1	<b>4,180.00</b>	
FLHI121/S/400	400	E40	428 x 505 x 144	1	<b>4,840.00</b>	
<i>Includes Ballast, Ignitor, Capacitor Only</i>						
		220V Operating Voltage				<b>IP65</b> IP Rating
		<b>Uranus Series</b> Metal Halide Floodlight Tubular Type				
FLHI181/S/1000	1000	E40	588 x 380 x 195	1	<b>18,700.00</b>	
<i>Includes Ballast, Ignitor, Capacitor Only</i>						
		220V Operating Voltage				<b>IP65</b> IP Rating
		<b>Jupiter Series</b> Metal Halide Floodlight Tubular Type				
FLHI194/C/1000	1000	E40	578 x 500 x 705	1	<b>17,600.00</b>	
<i>Includes Ballast, Ignitor, Capacitor Only</i>						

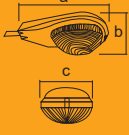

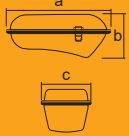
STREETLIGHTS	Wattage	Lamp Base	Dimensions	Packaging	Suggested Retail Price
	W		(a x b x c mm)	Pcs./Ctn.	SRP

Conventional Lighting

 	220V Operating Voltage					
	High Pressure Sodium Road Lighting Fixture					
	FLSRL070	70	E27	530 x 215 x 240	1	<b>3,630.00</b>
	FLSRL150	150	E27	530 x 215 x 240	1	<b>3,960.00</b>
Includes Ballast, Ignitor, Capacitor Only						
HPS Casing Only						
YFSLR 70/150	70 / 150	E27	530 x 215 x 240		<b>2,200.00</b>	
 	220V Operating Voltage					
	High Pressure Sodium Road Lighting Fixture					
	FLSRL250	250	E40	670 x 270 x 325	1	<b>6,160.00</b>
	Includes Ballast, Ignitor, Capacitor Only					
HPS Casing Only						
YFSLR250	250	E40	670 x 270 x 325		<b>4,199.95</b>	
 	220V Operating Voltage					
	High Pressure Sodium Road Lighting Fixture					
	FLSRL400	400	E40	760 x 285 x 345	1	<b>7,150.00</b>
	Includes Ballast, Ignitor, Capacitor Only					
HPS Casing Only						
YFSLR400	400	E40	760 x 285 x 345	1	<b>4,299.95</b>	
 	220V Operating Voltage					
	Security Light for Compact Fluorescent Lamp					
	FLSR101	36W Max.	1 Lamp CFL	320 x 135 x 145	8	<b>880.00</b>
	FLSR103	2 x 18W Max.	2 Lamps CFL	320 x 135 x 145	8	<b>990.00</b>
 <b>Photocell</b> FLRLPCELL Max. up to 1000W <b>2,200.00</b>						

LAMP POST	Dimensions	Suggested Retail Price
	(a x b x c)	SRP

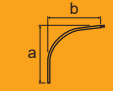
(All prices are FOB Manila only)  
 • Hot dip galvanized Lamp Post and Arm  
 • With base plate



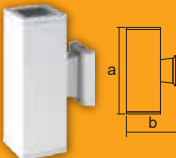
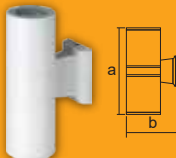
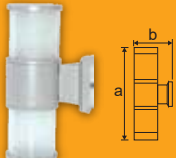
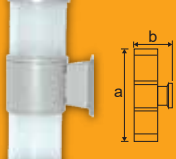

 	Single Arm for Lamp Post	
	FRL3-SA5X5.4	Single Arm for All Lamp Posts 5 ft. x 5.4 ft. <b>3,345.00</b>
 	Double Arm for Lamp Post	
	FRL/DA5X10	Double Arm for All Lamp Posts 5 ft. x 10 ft. <b>5,065.00</b>
Lamp Post		
FRL3-P15-4	Post for Lamp Post 15'	10 ft. x 105 mm Ø <b>7,780.00</b>
FRL3-P20-5	Post for Lamp Post 20'	15 ft. x 125 mm Ø <b>11,220.00</b>
FRL4-P25-5	Post for Lamp Post 25'	20 ft. x 150 mm Ø <b>15,830.00</b>
FRL4-P30-6	Post for Lamp Post 30'	25 ft. x 175 mm Ø <b>21,420.00</b>
Anchor Bolt		
FRLA-M18-100X500	Anchor Bolt for Lamp Post 15'	M18 x 500 mm x 100 mm <b>510.00</b>
FRLA-M18-100X600	Anchor Bolt for Lamp Post 20'	M18 x 600 mm x 100 mm <b>555.00</b>
FRLA-M20-100X600	Anchor Bolt for Lamp Post 25'	M20 x 600 mm x 100 mm <b>690.00</b>
FRLA-M20-100X700	Anchor Bolt for Lamp Post 30'	M20 x 700 mm x 100 mm <b>780.00</b>
Note: Hot dipped galvanized		

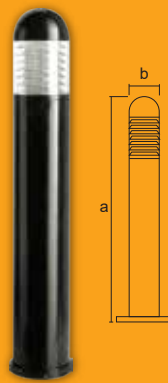

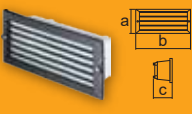
STRING LIGHTS		Lamp Base	Dimensions	PKG.	Suggested Retail Price
			(a x b mm)	Pcs./Ctn.	SRP
	String Lights				<b>IP65</b> IP Rating
	FELH301	10 x E27	30 ft.		<b>2,145.00</b>
11 pcs. LED bulbs included					

WALL LAMPS		Lamp Base	Dimensions	PKG.	Suggested Retail Price
			(a x b mm)	Pcs./Ctn.	SRP
	Projection Light				<b>IP65</b> IP Rating
	FOWL721	2 x E27	260 X 150		<b>1,870.00</b>
Fixture Only					
	Outdoor Wall Lamp				<b>IP65</b> IP Rating
	FOWL711	2 x E27	260 X 155	10	<b>2,070.00</b>
Fixture Only					
	Outdoor Wall Lamp				<b>IP65</b> IP Rating
	FOWL713	2 x E27	315 x 155	12	<b>1,410.00</b>
Fixture Only					
	Outdoor Wall Lamp				<b>IP65</b> IP Rating
	FOWL714	2 x E27	315 x 167	12	<b>2,205.00</b>
Fixture Only					

BOLLARDS		Lamp Base	Dimensions	PKG.	Suggested Retail Price
			(a x b mm)	Pcs./Ctn.	SRP
	Outdoor Bollard				<b>IP65</b> IP Rating
	FOBO911	E27	900 x 135	4	<b>3,999.95</b>
Fixture Only					
	Outdoor Bollard				<b>IP65</b> IP Rating
	FOBO912	E27	900 x 135	4	<b>3,999.95</b>
Fixture Only					

PATHWAY		Dimensions	PKG.	Suggested Retail Price
		(a x b mm)	Pcs./Ctn.	SRP
	Pathway Luminaire Recessed Type, IP44			
	FWL522	100 x 223 x 70	20	<b>400.00</b>
Fixture Only				

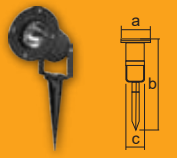
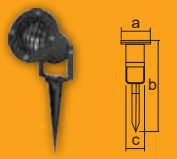
GLOBE GARDEN LAMPS		Dimensions	PKG.	Suggested Retail Price
		(a x b mm)	Pcs./Ctn.	SRP
	Prismatic Clear Diffuser Post Installation, IP44			
	FOGL511/8	203 x 100	12	<b>320.00</b>
Fixture Only				
	Prismatic Smoke Diffuser Post Installation, IP44			
	FOGL512/8	203 x 100	12	<b>320.00</b>
Fixture Only				
	Plain Clear Diffuser Post Installation, IP44			
	FOGL531/8	203 x 100	12	<b>240.00</b>
Fixture Only				
	Plain White Opal Diffuser Post Installation, IP44			
	FOGL533/8	203 x 100	12	<b>230.00</b>
Fixture Only				
	Plain White Opal Diffuser Post Installation, IP44			
	FOGL533/10	254 x 126	12	<b>330.00</b>
Fixture Only				

OUTDOOR IN-GROUND		Dimensions	PKG.	Suggested Retail Price
		(a x b mm)	Pcs./Ctn.	SRP
	Garden Lamp-outdoor Halogen Dichroic Lamp, GU5.3			<b>IP65</b> IP Rating
	FGLH111	98 x 320 x 68	20	<b>520.00</b>
Fixture Only				
	Garden Lamp-outdoor Halogen Dichroic Lamp, GU5.3			<b>IP65</b> IP Rating
	FGLH121	98 x 320 x 68	20	<b>520.00</b>
Fixture Only				
	Outdoor In-ground for E27 Lampholder			<b>IP65</b> IP Rating
	FOIG312	170 x 200 x 130	6	<b>1,599.95</b>
Fixture Only				

WALL OR TUNNEL LIGHTINGS		Dimensions	PKG.	Suggested Retail Price
		(a x b mm)	Pcs./Ctn.	SRP
	Triton Series, IP44			
	FLHI511	330 x 230 x 185		<b>3,410.00</b>
Fixture Only				

Conventional Lighting

OUTDOOR LAMPHOLDER					OUTDOOR LAMPHOLDER				
Wattage	Dimensions	PKG.	Suggested Retail Price		Wattage	Dimensions	PKG.	Suggested Retail Price	
W	(a x b mm)	Pcs./Ctn.	SRP		W	(a x b mm)	Pcs./Ctn.	SRP	
 <p>Weatherproof E27 Lampholder In-ground for PAR30 &amp; PAR38 Lamps <b>IP Rating</b></p>					 <p>Weatherproof E27 Lampholder Wall / Eaves Mount for PAR30 &amp; PAR38 Lamps <b>IP Rating</b></p>				
FELH201	150	60.84 x 379	12	<b>340.00</b>	FELH211	150	171.2 x 115	12	<b>310.00</b>
<i>Fixture Only</i>					<i>Fixture Only</i>				
 <p>Weatherproof Twin E27 Lampholder In-ground for PAR30 &amp; PAR38 Lamps <b>IP Rating</b></p>					 <p>Weatherproof Twin E27 Lampholder Wall / Eaves Mount for PAR30 &amp; PAR38 Lamps <b>IP Rating</b></p>				
FELH202	2x150	339 x 201.6	12	<b>530.00</b>	FELH212	2x150	99.5 x 339.5	12	<b>530.00</b>
<i>Fixture Only</i>					<i>Fixture Only</i>				
GARDEN LANTERN					GARDEN LANTERN				
Lamp Base	Dimensions	PKG.	Suggested Retail Price		Lamp Base	Dimensions	PKG.	Suggested Retail Price	
	(a x b mm)	Pcs./Ctn.	SRP			(a x b mm)	Pcs./Ctn.	SRP	
 <p>Post Series <b>IP43</b> <b>IP Rating</b></p>					 <p>Wall Series <b>IP43</b> <b>IP Rating</b></p>				
FLES921	E27	410 x 175	10	<b>470.00</b>	FLES911	E27	360 x 210	10	<b>485.00</b>
FLES922	E27	515 x 215	10	<b>800.00</b>	FLES912	E27	420 x 235	10	<b>825.00</b>
<i>Fixture Only</i>					<i>Fixture Only</i>				
 <p>Post Series <b>IP43</b> <b>IP Rating</b></p>					 <p>Wall Series <b>IP43</b> <b>IP Rating</b></p>				
FLES923	E27	400 x 165	10	<b>560.00</b>	FLES913	E27	353 x 192	10	<b>590.00</b>
<i>Fixture Only</i>					<i>Fixture Only</i>				
 <p>Post Series <b>IP43</b> <b>IP Rating</b></p>					 <p>Wall Series <b>IP43</b> <b>IP Rating</b></p>				
FLES941	E27	400 x 205	8	<b>1,025.00</b>	FLES931	E27	355 x 220	8	<b>1,025.00</b>
<i>Fixture Only</i>					<i>Fixture Only</i>				
 <p>Post Series <b>IP43</b> <b>IP Rating</b></p>					 <p>Wall Series <b>IP43</b> <b>IP Rating</b></p>				
FLES925	E27	400 x 150	10	<b>515.00</b>	FLES915	E27	375 x 210	10	<b>505.00</b>
FLES926	E27	440 x 185	8	<b>825.00</b>	<i>Fixture Only</i>				
<i>Fixture Only</i>					<i>Fixture Only</i>				
 <p>Post Series <b>IP43</b> <b>IP Rating</b></p>					 <p>Wall Series <b>IP43</b> <b>IP Rating</b></p>				
FLES928	E27	475 x 160	10	<b>770.00</b>	FLES918	E27	420 x 195	10	<b>770.00</b>
<i>Fixture Only</i>					<i>Fixture Only</i>				

Conventional Lighting