

CLASSIC MIRROR OPERATING LIGHT



RTO LIGHTING

SPEC SHEET

CLASSIC MIRROR OPERATING LIGHT

DESCRIPTION

Eye-catching with its clean details and unique form, the Classic Operating Light multiplies the light with its intriguing mix of metal and glass.

LAMPING

We suggest the use of LED bulbs under 40 Watts. In order to reduce the consumption of electricity and to ensure the lifetime guarantee of our products. Incandescent bulbs emit heat that can cause damage to the luminaire overtime.

E26 Lamp Base. 120VAC

SPECIFICATIONS

Materials: Galvanized Steel, Glass, Brass (All finishes are lacquered).

List price includes 36" overall drop. Additional charges apply for drops over 36".

Canopy: 4 -1/2" Diameter.

Dimming compatible.

This item is made-to-order with a 10-12 week production lead time prior to shipping.

ARM FINISH



Oil Rubbed Bronze

Finish samples available upon request.

CERTIFICATIONS

cUL, UL Certified.

CE certification available upon request.

Dry location rated.



GLASS FINISH



Milk Glass



Clear Glass



Ribbon Glass

Finish samples available upon request.

PRODUCT CARE

Please care for the brass pieces with a soft cloth. Avoid using any abrasive cleaners or products. Natural patina process is quickened by touch and exposure.

Gloves are recommended for installation.

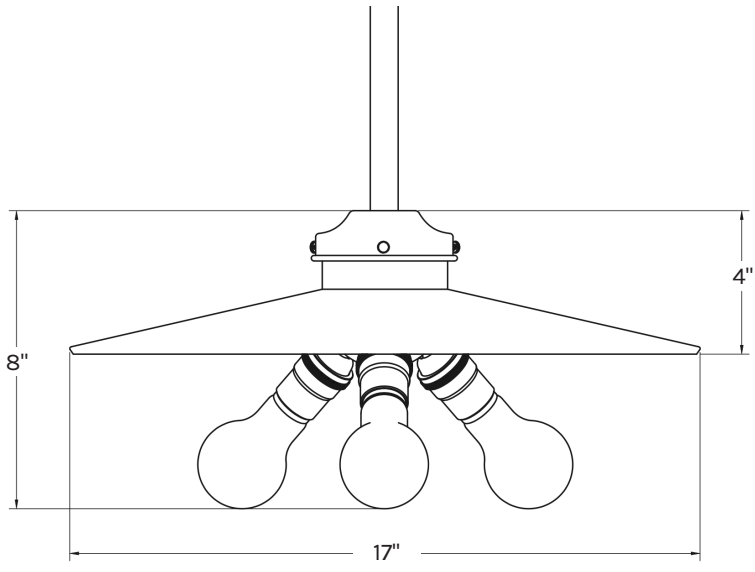
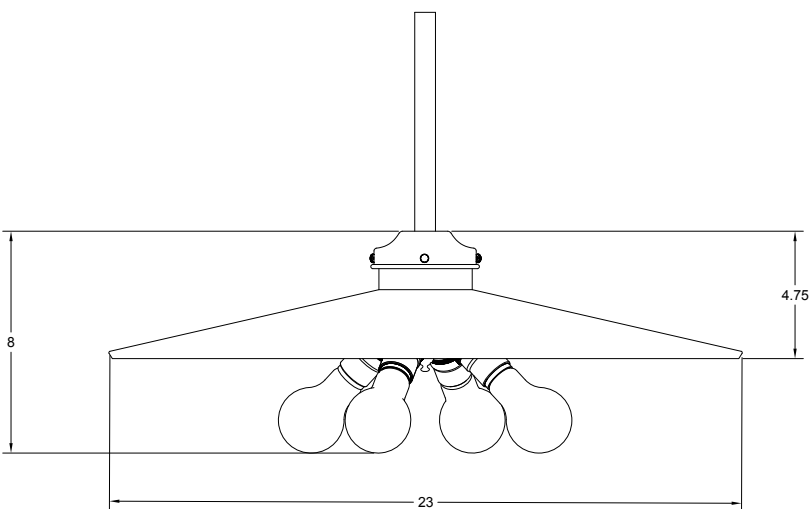
<p>17" - OPERATING LIGHT</p> 	<p>DIMENSIONS</p> <p>Overall Dimensions:</p> <ul style="list-style-type: none"> - Shade: 17" Dia x 8" H - 3 Sockets - Overall Drop: 36" - Weight: 7 lbs.
<p>23" - OPERATING LIGHT</p> 	<p>DIMENSIONS</p> <p>Overall Dimensions:</p> <ul style="list-style-type: none"> - Shade: 23" Dia x 8" H - 4 Sockets - Overall Drop: 36"

29" - OPERATING LIGHT

DIMENSIONS

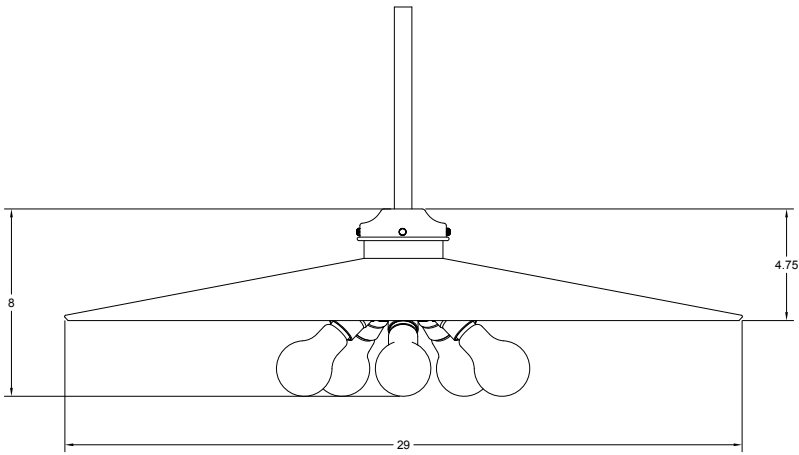

- Overall Dimensions:
- Shade: 29" Dia x 8" H
 - 5 Sockets
 - Overall Drop: 36"
 - Weight: 15 lbs.