

SHAD
ENGINEERED FOR RIDING



PIONEERS / EXPANDABILITY

WWW.SHAD.ES



INDEX

NEW SH38X

P. 4

SRP PRICE LIST

P. 8

COMPANY

P. 32

TERRA



TOP



SIDE



ACCESSORIES

CASES

FITTING KITS

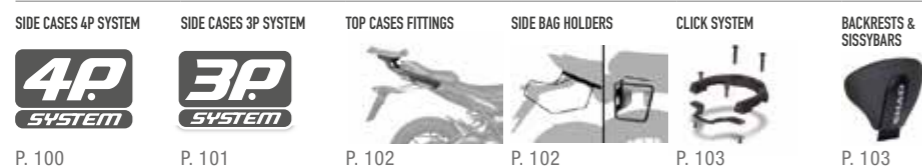

COMFORT SEATS



BAGS

TERRA

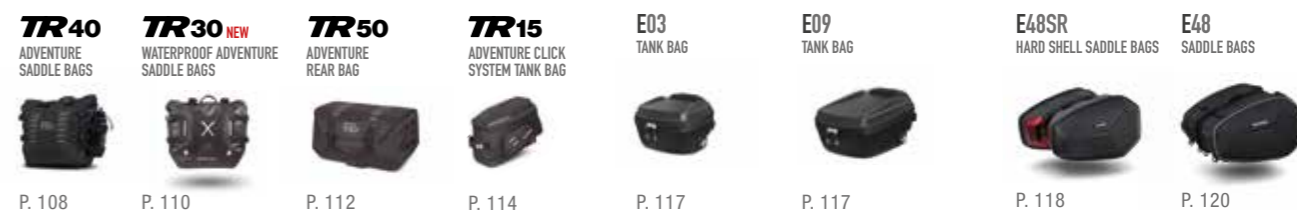

TOURING



CAFE RACER



RIDER



ATV CASES



SHAD LOCKS



FULLY EQUIPPED

P. 138

SPARE PARTS

P. 139

SHAD SUPPORT

P. 139

DISPLAYS

P. 140

ICONS

P. 143



PIONEERS / EXPANDABILITY



ENGINEERED FOR RIDING

SHAD | Pioneers in expandability, presents the new expandable side case.

A telescopically expandable case with a compensated tension cable system.

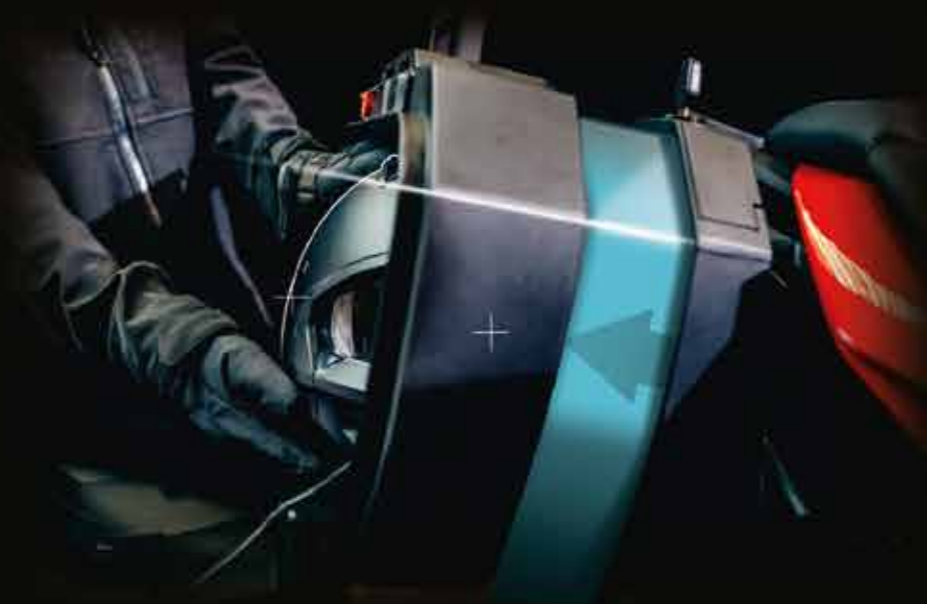

EXPANDABILITY 40%

MODULAR HELMET 1 CAPACITY



DESIGN PROCESS



SH38X / EXPANDABLE



INSPIRATION

TENSEGRITY is a form of construction that uses rigid elements interconnected by tensioned cables or ropes to create strong, flexible, and adaptable structures. It is used in structural engineering, architecture, and mechanical systems design. In nature we find it in the human body within the bone structure, the muscular system, the connective tissue, as well as spider webs, bird nests and fern leaves.



De: Dinterwepke - Tropic graphic, CC BY-SA 2.5 NL
https://commons.wikimedia.org/wiki/File:Grafic_0120206

D & L - L&L VISUALS - CC BY-SA 3.0
https://commons.wikimedia.org/wiki/File:Grafic_0120206

HOW IT WORKS

To allow a smooth and uniform expansion, SHAD developed a tension cable system with 4 incorporated guides inside of the case's frame. Creating **DYNAMIC TENSEGRITY**.

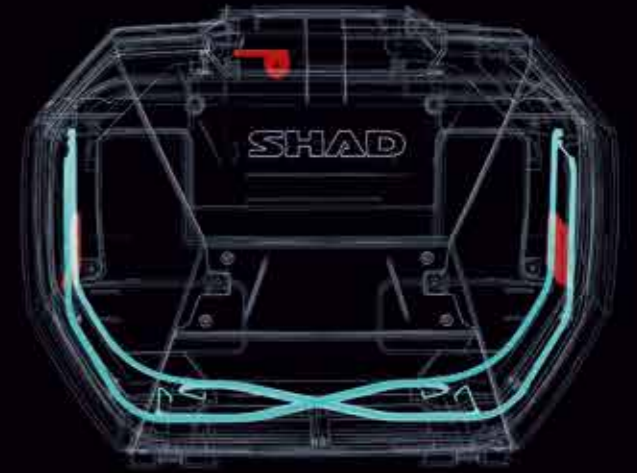

ENGINEERED FOR RIDING

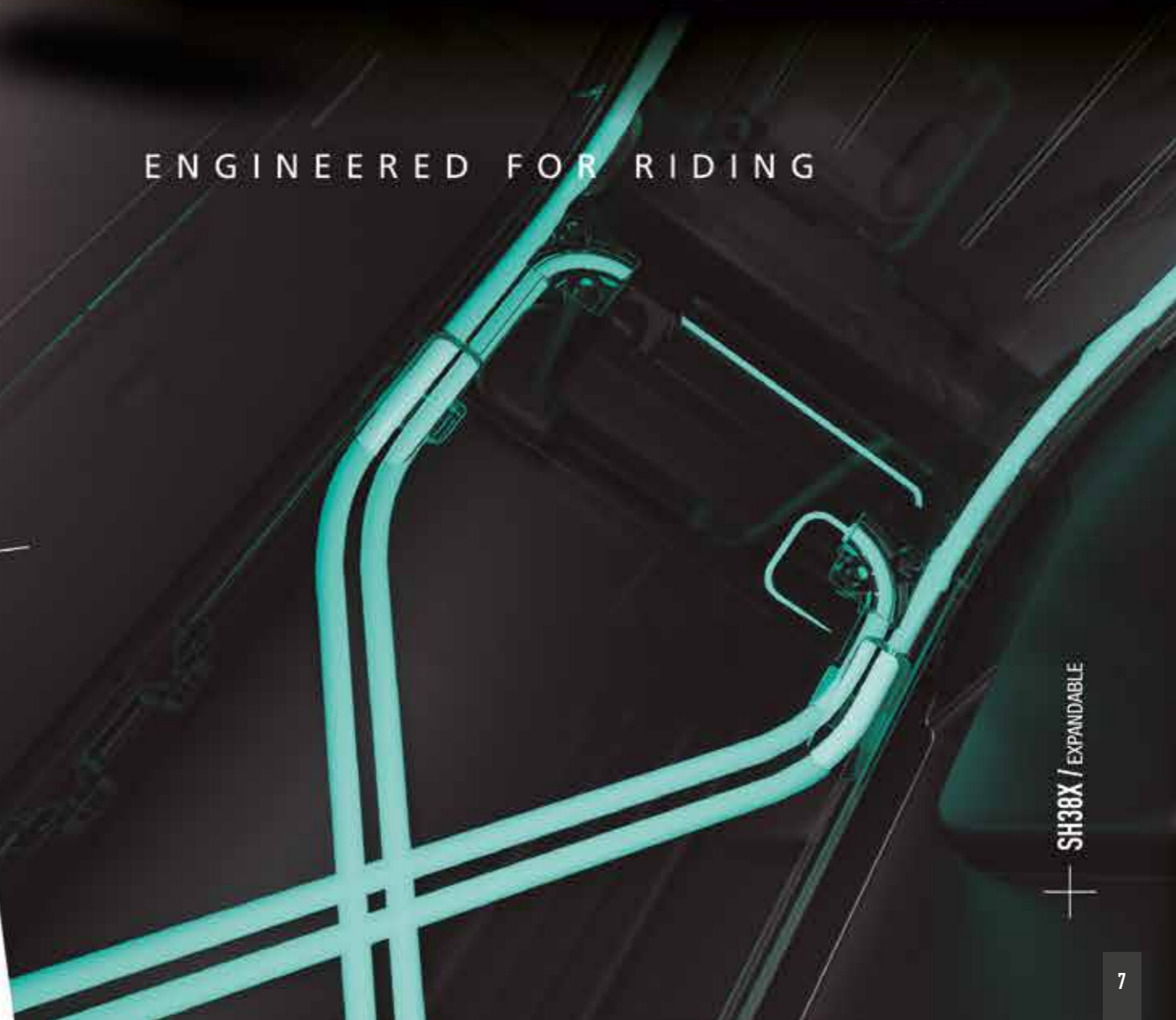

SH38X / EXPANDABLE

SRP PRICE LIST (VAT INCLUDED)

Conditions of purchase ^(*)

Recommendations

- SHAD recommends keeping our suggested public price on ecommerce sites (Suggested Retail Price).
- SHAD recommends checking the current legal regulations for any installation that involves the alteration of any original component of the motorcycle.

Guarantee and claims

All SHAD products are subject to a limited warranty (minimum of 24 months from the date of purchase), modifiable according to the current legislation of each country; according to the proper use and correct assembly indicated by the brand. The end customer is entitled

to request the guarantee of his/her product, always provided with the proof of purchase (purchase receipt, invoice or cash receipt). It is necessary to keep the original packaging of the product for 30 days to qualify for subsequent claims.

NOTE: ALL TESTS OF OUR PRODUCTS HAVE BEEN CARRIED OUT WITH THE ORIGINAL (UNMODIFIED) MOTORCYCLES.

The assembly of the SHAD products on in third-party mounting plates and racks, as well as the alteration, MODIFICATION OR ALTERATION of our products or original motorcycle elements will not be covered by the SHAD warranty.

Condiciones de compra ^(*)

Recomendaciones

- SHAD recomienda mantener en los apartados públicos de cualquier web nuestro precio público sugerido (Suggested Retail Price).
- SHAD recomienda verificar la normativa legal vigente para cualquier instalación que suponga la alteración de cualquier elemento original de la moto.

Garantías y reclamaciones

Todos los productos SHAD están sujetos a una garantía limitada (mínima de 24 meses desde la fecha de compra), modificable según la legislación vigente de cada país; siempre y cuando, los productos se usen correctamente, de acuerdo con el uso adecuado y el ensamblaje

correcto indicado por la marca. El cliente final tiene derecho a solicitar la garantía de su producto, siempre con el comprobante de compra (recibo de compra, factura o recibo de caja). Además, es necesario conservar el embalaje original del producto durante 30 días para optar a reclamaciones posteriores.

NOTA: TODAS LAS PRUEBAS DE NUESTROS PRODUCTOS HAN SIDO REALIZADAS CON EL EQUIPAMIENTO DE SERIE EN LAS DIFERENTES MOTOCICLETAS Y MODELOS,

El montaje del producto SHAD en fijaciones y parrillas de terceros, así como la alteración, MODIFICACIÓN O REFORMA de nuestros productos o de elementos originales de la moto suponen la pérdida de la garantía.

Condition d'achat ^(*)

Recommandations:

- SHAD recommande de conserver notre prix public suggéré (Suggested Retail Price) dans les sections publiques de n'importe quel site Web.
- SHAD recommande de vérifier la législation en vigueur pour toute installation qui implique la modification de tout élément d'origine de la moto.

Garanties et réclamations

Tous les produits SHAD sont soumis à une garantie limitée (minimum de 24 mois à compter de la date d'achat), modifiable selon la législation en vigueur de chaque pays; à condition que les produits soient utilisés correctement, en fonction de l'usage prévu et du

montage recommandé par la marque. Le client final est en droit de faire une demande de garantie sur son produit toujours avec la preuve d'achat (facture, reçu ou ticket de caisse). Il est nécessaire de conserver l'emballage d'origine du produit pendant 30 jours pour pouvoir prétendre à des réclamations ultérieures.

NOTE : TOUS LES TESTS DE NOS PRODUITS ONT ÉTÉ RÉALISÉS AVEC L'EQUIPEMENT DE SÉRIE SUR LES DIFFÉRENTS MODÈLES DE MOTO.

Le montage du produit SHAD sur des fixations et platines de tierces, ainsi que la modification, MODIFICATION OU RÉNOVATION de nos produits ou des éléments originaux de la moto entraînent la perte de la garantie.

Condizioni di acquisto ^(*)

Raccomandazioni

- SHAD consiglia di applicare il listino prezzi al pubblico suggerito (Suggested Retail Price) nelle sezioni pubbliche di qualsiasi sito web.
- SHAD consiglia di verificare la legislazione vigente per l'installazione di prodotti che comporti l'alterazione di qualsiasi elemento originale della motocicletta.

Garanzie e reclami

Tutti i prodotti SHAD sono soggetti a una garanzia limitata per eventuali difetti di fabbricazione (minimo 24 mesi dalla data di acquisto), modificabile secondo la legislazione vigente di ogni paese; a condizione che i prodotti siano utilizzati correttamente, nel rispetto dell'uso

corretto e del corretto assemblaggio indicato dal marchio. Il cliente finale ha facoltà di richiedere la garanzia del proprio prodotto, dietro presentazione di prova di acquisto (scontrino di acquisto, fattura o scontrino). È necessario conservare l'imballaggio originale del prodotto per 30 giorni al fine di poter avanzare successivamente reclami

NOTA: I TEST DEI NOSTRI PRODOTTI SONO STATI EFFETTUATI SULLE DIFFERENTI MOTO E MODELLI CON EQUIPAGGIAMENTO DI SERIE.

L'assemblaggio del prodotto SHAD su kit di fissaggio o piastre di terzi, l'alterazione, la MODIFICA o RIFORMA dei nostri prodotti o di elementi originali della motocicletta, comportano la perdita della garanzia.

Einkaufsbedingungen

Empfehlungen

- SHAD empfiehlt die Beibehaltung unseres empfohlenen Verkaufspreises in den öffentlichen Bereichen jeder Website
- SHAD empfiehlt, die geltende Gesetzgebung für jede Installation zu überprüfen, die die Änderung eines beliebigen Originalelements des Motorrades betrifft.

Garantien und Ansprüche

Alle SHAD-Produkte haben eine 24-monatige beschränkte Garantie, vorausgesetzt, die Produkte werden korrekt verwendet, in Übereinstimmung mit der ordnungsgemäßen Verwendung und der korrekten Montage, die von der Marke angegeben wird. Der Endkunde ist berechtigt,

die Garantie für sein Produkt zu verlangen, immer mit dem Kaufbeleg (Kaufbeleg, Rechnung oder Kassenzettel).

ANMERKUNG: ALLE TESTS UNSERER PRODUKTE WURDEN MIT DER SERIENAUSSTATTUNG DER VERSCHIEDENEN MOTORRÄDER UND MODELLE DURCHFÜHRT.

Die Montage des SHAD-Produktes an Haltern oder Adapterplatten von Drittherstellern, sowie die Veränderung, Modifikation oder Umgestaltung unserer Produkte oder von Original-Elementen des Motorrades führen zum Verlust der Garantie.

Condições de Compra

Recomendações

- A SHAD recomenda manter nas secções públicas de qualquer site o nosso preço de venda ao público sugerido (Suggested Retail Price)
- A SHAD recomenda verificar a legislação vigente para qualquer instalação que suponha a alteração de qualquer elemento original da moto.

Garantias e reclamações

Todos os produtos SHAD têm uma garantia limitada de 24 meses, sempre que os produtos sejam utilizados corretamente, de acordo com a utilização adequada e o encaixe correto indicado pela marca. O

cliente final tem direito a solicitar a garantia do seu produto, sempre com o comprovativo de compra (recibo de compra, fatura ou recibo de caixa). É necessário manter a embalagem original do produto por 30 dias para ter direito a reclamações posteriores.

NOTA: TODOS OS TESTES REALIZADOS AOS NOSSOS PRODUTOS FORAM FEITOS COM O EQUIPAMENTO DE SÉRIE NAS DIFERENTES MOTOCICLETAS E MODELOS.

A montagem do produto SHAD em fixações ou grelhas de terceiros, assim como a alteração, MODIFICAÇÃO OU REFORMA dos nossos produtos ou de elementos originais da moto supõem a perda da garantia.



^(*) More info at SHAD B2B
Más información en SHAD B2B
Plus d'informations sur SHAD B2B

^(*) Ulteriori informazioni su SHAD B2B

SHAD TERRA





ENGINEERED FOR RIDING

MORE INFO PAG 48

Terra Top Cases		Mounting Plate + Screws	Inner bag	Backrest
TR37 	D0TR37100	REQUIRED: D1B591PA/D1BTRPA/D1BTRPA2	X0IB47	D0RI75
TR48 	D0TR48100	REQUIRED: D1B591PA/D1BTRPA/D1BTRPA2	X0IB47	D0RI75
TR55 	D0TR55100	REQUIRED: D1B591PA/D1BTRPA/D1BTRPA2	X0IB10	D0RI75

Terra Side Cases		Inner bag	Inner Mesh	Lock + Key
TR36R 	D0TR36100R (right)	X0IB47	INCLUDED	INCLUDED*
TR36L 	D0TR36100L (left)	X0IB47		
TR47R 	D0TR47100R (right)	X0IB47	INCLUDED	INCLUDED*
TR47L 	D0TR47100L (left)	X0IB47		

* 3 cylinders for left, right and top cases + 2 keys





Terra Bags		Description	Accessories	Measurements	Master box
TR40 2u. 	X0TR401	Adventure Terra Saddle Bags 64L	X1TR03 (dry bag) / X1TR05 (bottle harness) INCLUDED	64L / 40 x 25 x 38 cm	1
TR30 2u. NEW 	X0TR30	Adventure Terra Saddle Bags 50L	X1TR03 (dry bag) / X1TR05 (bottle harness) INCLUDED	50L / 40 x 23 x 38 cm	1
TR50 	X0TR50	Adventure Rear Bag	X1TR03 (dry bag) / X1TR05 (bottle harness) INCLUDED	40L / 35 x 57 x 31,5 cm	2
TR15CL 	X0TR15CL	Adventure Click System Tank Bag - Locking	X1SESTLR (Lock Mechanism) INCLUDED	13L / 38 x 29 x 23 cm	4
TR15 	X0TR15C	Adventure Click System Tank Bag	X1SESTLR (Lock Mechanism) INCLUDED	13L / 38 x 29 x 23 cm.	4





SHAD TERRA BLACK EDITION ALUMINIUM CASES



TR37 | TR48 | TR55
BLACK EDITION
ALUMINIUM CASES

MORE INFO PAG 48

Terra Top Cases		Mounting Plate + Screws	Inner bag	Backrest
TR37 BLACK EDITION 	D0TR37100B	REQUIRED: D1B591PA/D1BTRPA/D1BTRPA2	X0IB47	D0RI75
TR48 BLACK EDITION 	D0TR48100B	REQUIRED: D1B591PA/D1BTRPA/D1BTRPA2	X0IB47	D0RI75
TR55 BLACK EDITION 	D0TR55100B	REQUIRED: D1B591PA/D1BTRPA/D1BTRPA2	X0IB10	D0RI75
TR55 BLACK EDITION Pure black 	D0TR55200B	REQUIRED: D1B591PA/D1BTRPA/D1BTRPA2	X0IB10	D0RI75

Terra Side Cases		Inner bag	Inner Mesh	Lock + Key
TR36R BLACK EDITION 	D0TR36100RB (right)	X0IB47	INCLUDED	INCLUDED*
TR36L BLACK EDITION 	D0TR36100LB (left)	X0IB47		
TR47R BLACK EDITION 	D0TR47100RB (right)	X0IB47	INCLUDED	INCLUDED*
TR47L BLACK EDITION 	D0TR47100LB (left)	X0IB47		







* 3 cylinders for left, right and top cases + 2 keys

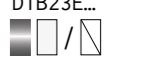

TOP CASES SRP 2024

	Top Cases	Packs	Mounting Plate + Screws	Inner bag	Backrest	Brake Light (unit price)	Upper Rack	Colour Covers
SH26	 D0B26100		S INCLUDED			D0B29KL (*)		
SH29	 D0B29100		S INCLUDED		D0RI40	D0B29KL (*)		D1B29E... 
SH33	 D0B33200		S INCLUDED		D0RI40	D0B29KL (*)		D1B33E8... 
SH34	 D0B34106 (carbon cover INCLUDED)		S INCLUDED		D0RI40	D0B29KL (*)		D1B34E06 
SH37	 D0B37100		S INCLUDED		D0RI60	D0B29KL (*)		D1B37E... 
SH39	 D0B39100	D0B39106 (carbon cover INCLUDED)	M INCLUDED		D0RI3900	D0B40KL (*)		D1B39E... 
SH40	 D0B40100	D0B40200 (alu look cover INCLUDED)	M INCLUDED		D0RI60	D0B40KL (*)		D1B40E... 
SH40 CARGO	 D0B40199		M INCLUDED		D0RI60	D0B40KL (*)		
SH44	 D0B44100		M INCLUDED	X0IB00	D0RI60	D0B40KL (*)		
SH45	 D0B45100		M INCLUDED	X0IB00	D0RI60	D0B40KL (*)		D1B45E... 
SH46	 D0B46200		M INCLUDED	X0IB00	D0RI50	D0B40KL (*)	D0PS00	
SH47 WHITE	 D0B47106 (carbon cover INCLUDED)		M INCLUDED	X0IB00	D0RI47	D0B40KL (*)		D1B47E... 
SH47 RED	 D0B47206 (carbon cover INCLUDED)		M INCLUDED	X0IB00	D0RI47	D0B40KL (*)		D1B47E... 
SH48 DARK GREY	 D0B48300	D0B48306R (*)	B: INCLUDED A: D1BTRPA / D1BTRPA2	X0IB00	D0RI4800	D0B29KL (*)	D0PS00	D1B48E... 
SH48 NEW TITANIUM	 D0B48400	D0B48406R (*)	B: INCLUDED A: D1BTRPA / D1BTRPA2	X0IB00	D0RI4800	D0B29KL (*)	D0PS00	D1B48E... 
SH50 BACK REST INCLUDED	 D0B5000		B: INCLUDED A: D1BTRPA / D1BTRPA2	X0IB00	INCLUDED	D0B29KL (*)	D0PS00	D1B50E... 
SH58X CARBON	 D0B58206 (carbon cover INCLUDED)		B: INCLUDED A: D1BTRPA / D1BTRPA2	X0IB59	D0RI80	D0B29KL (*)		D1B58E... 
SH59X ALUMINIUM	 D0B59200		B: INCLUDED A: D1BTRPA / D1BTRPA2	X0IB59	D0RI80	D0B29KL (*)		

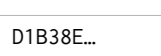
SIDE CASES

	Side Cases	Packs	Inner bag	Colour Covers
SH23 2 u.	 D0B23100	D0B23200W (alu look cover INCLUDED)		D1B23E... 
SH35 ALUMINIUM 2 u.	 D0B35200		X0IB36	
SH36 2 u.	 D0B36200 (carbon cover INCLUDED)		X0IB36	D1B36E... 
NEW SH38X CARBON 2 u.	 D0B38106 (carbon cover INCLUDED)		X0IB38	D1B38E... 
NEW SH38X 2 u.	 D0B38200		X0IB38	

■ 01 - Blue
 ■ 05 - Silver
 ■ 06 - Carbon
 ■ 08 - White
 ■ 09 - Red
 ■ 15 - New titanium
 ■ 17 - Dark Grey
 ■ 21 - Black
 ER - Non painted cover

(*) These references are not sold separately. On sale in 3 units pack. (**) Buying a minimum number of units

PLATES



S
Small Plate
Ref. D1B29PAR



M
Medium Plate
Ref. D1B40PAR



B
Big Plate
Ref. D1B59PAR



A
Aluminium Plates (OPTIONAL)
Aluminium Plate- Ref. D1BTRPA
Black Aluminium Plate
Ref. D1BTRPA2

DISPLAYS



D0EX201

Display	Ref.	Price
3 TOP CASES WALL DISPLAY	D0EX02	
3 TOP CASES WALL DISPLAY (SH59X/SH58X/SH50/49/48)	D0EX10	
3 TOP CASES FLOOR STAND	D0EX23	
9 TOP CASES WALL DISPLAY (SH59X/SH58X/SH50/49/48)	2 D0EX02 + 1 D0EX10 + 1 D0EX03	
9 TOP CASES WALL DISPLAY	3 D0EX02 + 1 D0EX03	
3P SYSTEM DISPLAY (TR40/SH38X/SH36/SH35/SH23 DISPLAY)	D0EX201	
EXPANDABLE SIGN FOR CUBE (SH59X/SH58X)	D0EX58	
4P SYSTEM DISPLAY (TERRA/TR40/SH38X/SH36/SH35 DISPLAY)	D0TR201	
TOP CASE WALL DISPLAY	D0EXTRP	
TOP CASES SLATWALL DISPLAY	D0EXTRR	
3P SYSTEM WALL DISPLAY	D0EXP4P	
4P SYSTEM WALL DISPLAY	D0EXP4P	
CLICK SYSTEM DISPLAY	D0EX14	
CLICK SYSTEM TABLE DISPLAY	D0EX01CS	

SPARE PARTS – TOP CASES SRP 2024

Top Cases	Mounting Plate	Mounting Plate Screws	Reflector	Locking System	Lock Kit + Keys	Lid Stop Strap
SH26	D1B29PAR	D1BABOR	D1B261CAR	D1B29MAR	201722R	D1B1TIR
SH29	D1B29PAR	D1BABOR	D1B291CAR	D1B29MAR	201722R	D1B1TIR
SH33	D1B29PAR	D1BABOR	D1B331CAR	D1B341MAR	201722R	D1B1TIR
SH34	D1B29PAR	D1BABOR	D1B341CAR ⁽¹⁾ D1B342CAR ⁽²⁾	D1B341MAR	201722R	D1B1TIR
SH37	D1B37PAR	D1B37BOR	D1B371CAPR	D1B37MAR	201722R	D1B1TIR
SH39	D1B40PAR	D1B40BOR	D1B39CAR	D1B391MAR	201722R	D1B1TIR
SH40 CARGO	D1B40PAR	D1B40BOR	D1B401CAR D1B403CAR(alu look)	D1B45MAR	201722R	D1B1TIR
SH44	D1B40PAR	D1B40BOR	D1B441CAR	D1B44MAR	201722R	D1B1TIR
SH45	D1B40PAR	D1B40BOR	D1B451CAR	D1B45MAR	201722R	D1B1TIR
SH46	D1B40PAR	D1B40BOR	D1B465CAR	D1B46MAR	201722R	D1B1TIR
SH47	D1B40PAR	D1B40BOR	D1B47CAR (white) D1B471CAR (red)	D1B47MAR	201722R	D1B1TIR
SH48 DARK GREY	D1B59PAR	D1B40BOR	D1B48CAR	D1B481MAR ⁽³⁾ D1B481PMAR ⁽⁴⁾	201896R ⁽³⁾ 203076R ⁽⁴⁾	D1B1TIR
SH48 NEW TITANIUM	D1B59PAR	D1B40BOR	D1B48CAR	D1B482MAR ⁽³⁾ D1B482PMAR ⁽⁴⁾	201896R ⁽³⁾ 203076R ⁽⁴⁾	D1B1TIR
SH50	D1B59PAR	D1B40BOR	D1B50CAR	D1B50MAR	201896R	D1B1TIR
SH58X	D1B59PAR	D1B40BOR	D1B58CAR	D1B59MAR ⁽³⁾ D1B59PMAR ⁽⁴⁾	201896R ⁽³⁾ 203076R ⁽⁴⁾	D1B6TIR
SH59X	D1B59PAR	D1B40BOR	D1B59CAR	D1B59MAR ⁽³⁾ D1B59PMAR ⁽⁴⁾	201896R ⁽³⁾ 203076R ⁽⁴⁾	D1B6TIR
TR37				D1TRTSR (upper part) D1TR37MIR (lower part)	D1TRB01R	D1B6TIR
TR48				D1TRTSR (upper part) D1TR48MIR (lower part)	D1TRB01R	D1B6TIR
TR55				D1TRTSR (upper part) D1TRTSTBR (upper part pure black) D1TR48MIR (lower part) D1TR48TIBR (lower part pure)	D1TRB01R	D1B6TIR

SPARE PARTS – SIDE CASES



SH23				D1B23CAR D1B231CAR (alu look)	D1B23MAR	*200062R
SH35					D1B362MAR ⁽⁴⁾	*200062R ⁽³⁾ *203134R ⁽⁴⁾ *203134R1 ⁽⁵⁾
SH36				D1B36CAR ⁽³⁾ D1B361CAR ⁽⁴⁾	D1B362MAR ⁽⁴⁾	*200062R ⁽³⁾ *203134R ⁽⁴⁾ *203134R1 ⁽⁵⁾
SH38X						203134R
TR36					D1TRTSR (upper part) D1TR36MIR (lower part)	D1TRBOR
TR47					D1TRTSR (upper part) D1TR47MIR (lower part)	D1TRBOR

SPARE PARTS- CASES









Hinge	Stickers	Box Seal Gasket	Cargo Strap	Side Band	Backrest screws	Rubber Stoppers	Others
201775R					D1RIBOR ⁽⁷⁾		
201775R	D1B291ETR				D1RIBOR ⁽⁷⁾		
201775R	D1B332ETR				D1RIBOR ⁽⁷⁾		
201775R	501588R				D1RIBOR ⁽⁷⁾		D1B34E06 (carbon cover)
201121R	D1B371ETR	400271R			D1RIBOR ⁽⁷⁾	200723R	
201121R	D1B39ETR				D1RIBOR ⁽⁷⁾	202546R	
201121R	D1B401ETR 501910R (alu look)	400271R			D1RIBOR ⁽⁷⁾	202546R	D1B40PTR (Upper Rack) D1B40E25 (cover alu look)
200784R	D1B44ETR	202467_4R			D1RIBOR ⁽⁷⁾	202546R	
201121R	D1B451ETR	400271R	D1B45CGR		D1RIBOR ⁽⁷⁾	202546R	
201121R	D1B461ETR	400271R	D1B46CGR		D1RIBOR ⁽⁷⁾	202546R	
200784R	D1B47ETR	202467_3R			D1RIBOR ⁽⁷⁾	202546R	D1B47E06 (carbon cover)
200784R	D1B481ETR	400341_5R	D1B48CGR	D1B481EMR	D1RIBOR ⁽⁸⁾	200507R	
200784R	D1B482ETR	400341_5R	D1B48CGR	D1B482EMR	D1RIBOR ⁽⁸⁾	200507R	
200784R		400269R2	D1B50CGR	D1B50EMR	D1RIBOR ⁽⁸⁾	200507R	D0RI70(backrest)
200784R	D1B58ETR	400269R2	D1B59CGR	D1B59EMR	D1RIBOR ⁽⁹⁾	200507R	D1B59MEALR (Expandable system) D1B58E06 (carbon cover) 202589 (cover rear panel)
200784R	D1B59ETR	400269R2	D1B59CGR	D1B59EMR	D1RIBOR ⁽⁹⁾	200507R	D1B59MEALR (Expandable system) D1B59T0R (cover) 202589 (cover rear panel)
		203507R			D1RIBOR ⁽⁹⁾	200507R 203504R ⁽⁶⁾	X0TR02R (inner mat) 203471R (alu cover) 203471RB (black alu cover)
		203507R			D1RIBOR ⁽⁹⁾	200507R 203504R ⁽⁶⁾	X0TR02R (inner mat) 203471R (alu cover) 203471RB (black alu cover)
		203507R			D1RIBOR ⁽⁹⁾	200507R 203504R ⁽⁶⁾	X0TR03R (inner mat) 203913R (alu cover) 203913RB (black alu cover)

D1B5TIR	201775R	501720R 501909R (alu look)				D1B23GOR	D1B23FIR (fitting bracket)	D1B23E25 (cover alu look)
D1B5TIR	200784R		400341_8R	D1B36CGR			D1B3613PR (fitting bracket) 202601R (3P system stopper 1 un.)	D1B35TLR (left side lid) D1B35TRR (right side lid)
D1B5TIR	200784R	501424R	400341_8R	D1B36CGR			D1B3613PR (fitting bracket) 202601R (3P system stopper 1 un.)	D1B36E06 (carbon cover)
D1B7TIR	200784R	203480/1R		D1B38EMR		D1B38GOR	203173MR (3P system stopper 1 un.) 204632R (4P system stopper 1 un.) D1B38TAMR (alu cover)	X0B3801 (inner mesh) D1B38CER (elevator frame) 204135R (cover lids)
			203507R				D1TR361PR (fitting bracket)	203163R (alu cover) 203163RB (black alu cover)
			203507R				D1TR361PR (fitting bracket)	203163R (alu cover) 203163RB (black alu cover)

SPORT BAGS SRP 2024

	Ref.	Description	Measurements	Price	Qty x masterbox
	E04	X0SE04	Semi rigid small tank bag	3L / 29 26x10 cm	10
	E48 ^{2U.}	X0SE481	Semi rigid saddle bags	46-58L / 47x24/30x29 cm	4
	E48SR ^{2U.}	X0SE48SR	Semi rigid saddle bags	30L / 45x27x29 cm	1







TOURING BAGS

	Ref.	Description	Measurements	Price	Qty x masterbox
	SL58 ^{2U.}	X0SL58	Big saddle bags	46-58 L / 18-25x47x29cm	2
	SL20F	X0SL20F	Tank bag -straps fastener	15-20 L / 18-21x30x40cm	4
	SL12M	X0SL12M	Small tank bag-magnets	4 L / 10x30x19cm	15
	SL86	X0SL86	Backpack bag	26 L / 27x30x45cm	5
	SL05	X0SL05	Big leg bag	2 L / 11x25x15cm	32
	SL04	X0SL04	Small leg bag	0,5 L / 3x26x13cm	80
	SL03	X0SL03	Waist bag	3 L / 9x23x16cm	20
	SL01	X0SL01	Toll pass pouch	4x6x10cm	200
	SC25	X0SC25	Scooter bag	25 L / 38x26x27 cm	10







Ref.	Accessories For Soft Bags: Description	Price	Qty x box	Ref.	Accessories For Soft Bags: Description	Price	Qty x box
X1SL11	Magnets (4 u.): SL20F/SL12M/E04		40	X1SESTLR	Click System Lock		
X1SB97	Thermo Pad: E48SR/E48/SL58/SW42		25	200062R	3 Lock System Set SR38/E48SR		
X1SL90	Universal Base Tank: E04/SL20F/SL12M		45	X1SE48LR	Mechanism lock SR38/E48SR		
X1SL09	Straps for Tank Bag SL20F		-	203919R	Handle E48SR		
X1SL01	Rain cover for small tank bags: E04/SL12M		100	204115R	Set Lock System TR40/TR30		
X1SL02	Film protector		-	204116R	Set 3 Lock System TR40/TR30+Terra Top		
X1SESTCL	Combination lock kit			X1TR90LR	Lock System TR50		
X1SESTRIR	Click system Ring			D1TRB01R	Lock Kit Keys TR50		

* until stock ends

INNER BAGS FOR CASES







	Ref.	Description	Measurements	Price	Qty x masterbox
	IB00	X0IB00	Inner bag for top cases from SH44 to SH50	35 x 50 x 21 cm	8
	IB10	X0IB10	Inner bag for top cases from TR55	21/29 x 53 x 34cm	8
	IB59	X0IB59	Inner bag for SH59X / SH59X	21/28 x 50 x 39 cm	10
	IB47	X0IB47	Inner bag for terra side cases	44 x 36 x 10 cm	5
	IB36	X0IB36	Inner bag for SH35 & SH36	28 x 41 x 31cm	8
	IB38	X0IB38	Inner bag for SH38	40 x 29 x 15/18 cm	20

CLICK SYSTEM BAGS





	Ref.	Description	Litres / Mesures	Price	Qty x masterbox
	NEW E03 CL PRO	X0SE03CLP	Click System Tank Bag -DOUBLE LOCK + EXPANDABLE	3-4L/-23 x21x11-16 cm	12
	E03C	X0SE03C	Click System Tank Bag - No Locking	3L/23 x21x11 cm	12
	NEW E09 CL PRO	X0SE09CLP	Click System Tank Bag -DOUBLE LOCK + EXPANDABLE + SMARTPHONE HOLDER	5-8L/- 30x24,5x14-20 cm	8
	E09 CLD	X0SE09CLD	Click System Tank Bag -DOUBLE LOCK	5L/- 30x24,5x14 cm	8
	NEW E09 CM	X0SE09CM	Click System Tank Bag - MIDDLE POSITION	5L/- 30x24,5x14 cm	8
	E09C	X0SE09C	Click System Tank Bag - No Locking	5L/30x24,5x14 cm	8

ADVENTURE BAGS

100% **WATERPROOF**

	Ref.	Description	Measurements	Price	Qty x masterbox
	SW23	X0SW23B	Tank Bag	14L / 35x26x24	4
	SW38	X0SW38	Rear duffel bag	35L / 54x28	15
	SW42 ^{2U.}	X0SW42	Saddle bags	50L / 42x34x17	3
	SW45	X0SW45	Rear backpack	40L / 48x31x17	10
	IB20	X0IB20	Duffel Bag	20L / 54x24x3	25
	IB08	X0IB08	Small Duffel Bag	8L / 40x18x2	50

CAFE RACER BAGS

	Ref.	Description	Measurements	Price	Qty x masterbox
	SR18	X0SR18	Tank Bag	8L / 36x18x15 cm	9
	SR28	X0SR28	Rear bag	27L / 40x26x25 cm	4
	SR38 ^{1U.}	X0SR38	Saddle bag	10L /34x15x24 cm	6
	SR38 BLACK ^{1U.}	X0SR3821	Black Saddle bag	10L /34x15x24 cm	6

RAIN JACKETS SRP 2024

Size	Cm	Ref.	Price	Qty x masterbox
S	57	X0SR55S		40
M	59,5	X0SR55M		
L	62	X0SR55L		
XL	64,5	X0SR55XL		
XXL	67	X0SR55XXL		
3XL	69,5	X0SR553XL		



RAIN PANTS

Size	Cm	Ref.	Price	Qty x masterbox
S	34	X0SR20S		40
M	36,5	X0SR20M		
L	39	X0SR20L		
XL	41,5	X0SR20XL		
XXL	44	X0SR20XXL		
3XL	46,5	X0SR203XL		



HAND MUFFS

Ref.	Price	Qty x masterbox
X0SR00		10



SMARTPHONE HOLDERS

	Ref.	Description	Max. Phone Size	Price	Qty x masterbox
	X0SG62H	Smartphone holder	16x8		30
	X0SG71H	Smartphone holder	18x9		30
	X0SG76H	Smartphone holder with pocket	18x9		30
	X0SG00H	X-frame	18x9		45
	*X0SG20H	Smartphone holder	6x12		20
	X0SG62M	Smartphone holder	16x8		30
	X0SG71M	Smartphone holder	18x9		30
	X0SG76M	Smartphone holder with pocket	18x9		30
	X0SG00M	X-frame	18x9		45
Mirror bracket	*X0SG40M	GPS holder 4,3"	9x14		20

Ref.	Spare Parts Smartphone holders	Price
203966R	Handlebar fitting	
203967R	Mirror fitting	

Ref.	Spare Parts Smartphone holders	Price
X1SGMAR	Mirror adapter	
203884R	Safety Net	

* Until stock ends

ATV CASES

ATV110



Ref.	Description	Price
D0Q1100	Atv Case	
200537R	Locking system	
D1TV80R	Handle	
D1BQ8CAR	Reflector	
D0RI50	Backrest	
S1Q8BOR	Screw set	
D1Q11ETR	Stickers	
201528R	Lid stop strap	
200035R	Spring	

ATV80



Ref.	Description	Price
S0Q800	Atv Case	
200451R	Locking system	
D1TV80R	Handle	
D1BQ8CAR	Reflector	
D0RI50	Backrest	
S1Q8BOR	Screw set	
500545R	Stickers	
200452R	Lid stop strap	
200035R	Spring	

ATV40



Ref.	Description	Price
D0Q200	Atv Case	
200537R	Locking syst	
S1Q8BOR	Screw set	
500545R	stickers	
201481R	Lid stop strap	

COMFORT SEATS

Make, model and year	Ref.	Description	Price
KAWASAKI			
Z750 (07-13) / Z1000 (07-09)	SHK0Z1000C	BLACK, with DARK GREY seams	
YAMAHA			
T.MAX 500/530 (08-16)	SHY0T5320	BLACK, with WHITE seams	
FAZER FZ6 600 (04-10)	SHY0F7000	BLACK, with GREY seams	
MT 09 (13-18)	SHY0M9300	BLACK, with GREY seams	
PIAGGIO			
MP3 RL (07-12) / MP3 RST 125-250-100 (09-12) / MP3 LT 250-400 (09-13) MP3 500 SPORT/ BUSINESS (11-13)	SHV0M2320	BLACK, with GREY-BLUE seams	
HONDA			
CBR600F (2011-12) *	*SHH0B6200	BLACK, with GREY seams	
	*SHH0B6209	BLACK, with RED seams	
	*SHH0B6201	BLACK, with BLUE seams	

* Until stock ends

BACKRESTS

Colour	Ref.	Price	Colour	Ref.	Price	Colour	Ref.	Price	Colour	Ref.	Price
Black	D0RP00		Grey	D0RP05		White	D0RP08		Black	D0RP0N	

SPECIFIC BACKREST SUPPORT SOLD SEPARATELY

SHAD LOCKS

	Ref.	Description	Size	Measures	Price	Qty x master box
	SERIE 3	C0S303H	Handlebar lock serie 3	3	39x 4,4x3,8	12
		C0S305H	Handlebar lock serie 3	5	44,5x 4,4x3,8	
		C0S307H	Handlebar lock serie 3	7	50x4,4x3,8	
	SERIE 2	C0S203H	Handlebar lock serie 2	3	39x 4,4x3,8	
		C0S205H	Handlebar lock serie 2	5	44,5x 4,4x3,8	
		C0S207H	Handlebar lock serie 2	7	50x4,4x3,8	

WHY SHAD



reddot winner 2021



TERRA

SET **TR 55 / 36 / 47** ALUMINIUM CASES

MORE INFO



SINCE
1973



1.-WE MANUFACTURE FOR THE TOP BRANDS

The SHAD brand is part of NAD SL, a company with 50 years of experience, the market leader for OEM manufactures of motorcycle seats and cases for top brands such as BMW, Triumph, KTM, Honda,...



2.- THE MOST DESIGN AWARDED MOTORCYCLE CASES

In recent years, SHAD has achieved various international design awards for the Terra cases & bags, expandable top cases and the SH36 side case. Awards that reinforce our market position that our brand is achieving in terms of design and functionality for riders.



3.- INNOVATION

Our commitment to R&D has brought to the market many innovative solutions: eXpandable cases, 3P System & 4P System, terra cases & bags and click system.



4.- DESIGNED IN BARCELONA

All of our products are entirely designed and developed at our Barcelona headquarters. Moreover, we have a various production centers located in the Barcelona area.



5.-GROWING WORLDWIDE PRESENCE

Present in 5 continents we distribute our products to more than 80 countries.



6.-SOCIAL & ENVIRONMENTAL RESPONSIBILITY

We focus on promoting a responsible production processes, we take care to do our part to protect the planet and give a helping hand to a global network everywhere we operate.



7.-WARRANTY & QUALITY

All our products are subjected to exhaustive quality controls and have a warranty period according to local legislation; as long as the recommendations for use and assembly indicated by SHAD are respected.

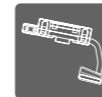

8.- RESISTANT & LIGHTWEIGHT FITTINGS

We create fitting systems adapted to different types of motorcycles and their use. Systems that are visually integrated on the motorcycle and ensure the strongest and safest solutions.



9.-COMFORT & EASY USE

Our cases are designed to be carried around easily. In addition, our locking systems can be operated with one hand.



10.- TOP CASE MOUNTING

Most of our top cases include the mounting plate and screw set to be installed in an easy and comfortable way. For Terra top cases, there are 3 mounting plate options available.

DESIGN IN BARCELONA

Since 1973

OUR CUSTOMERS

Every day we take on new technical and design challenges to maintain the trust of our customers.

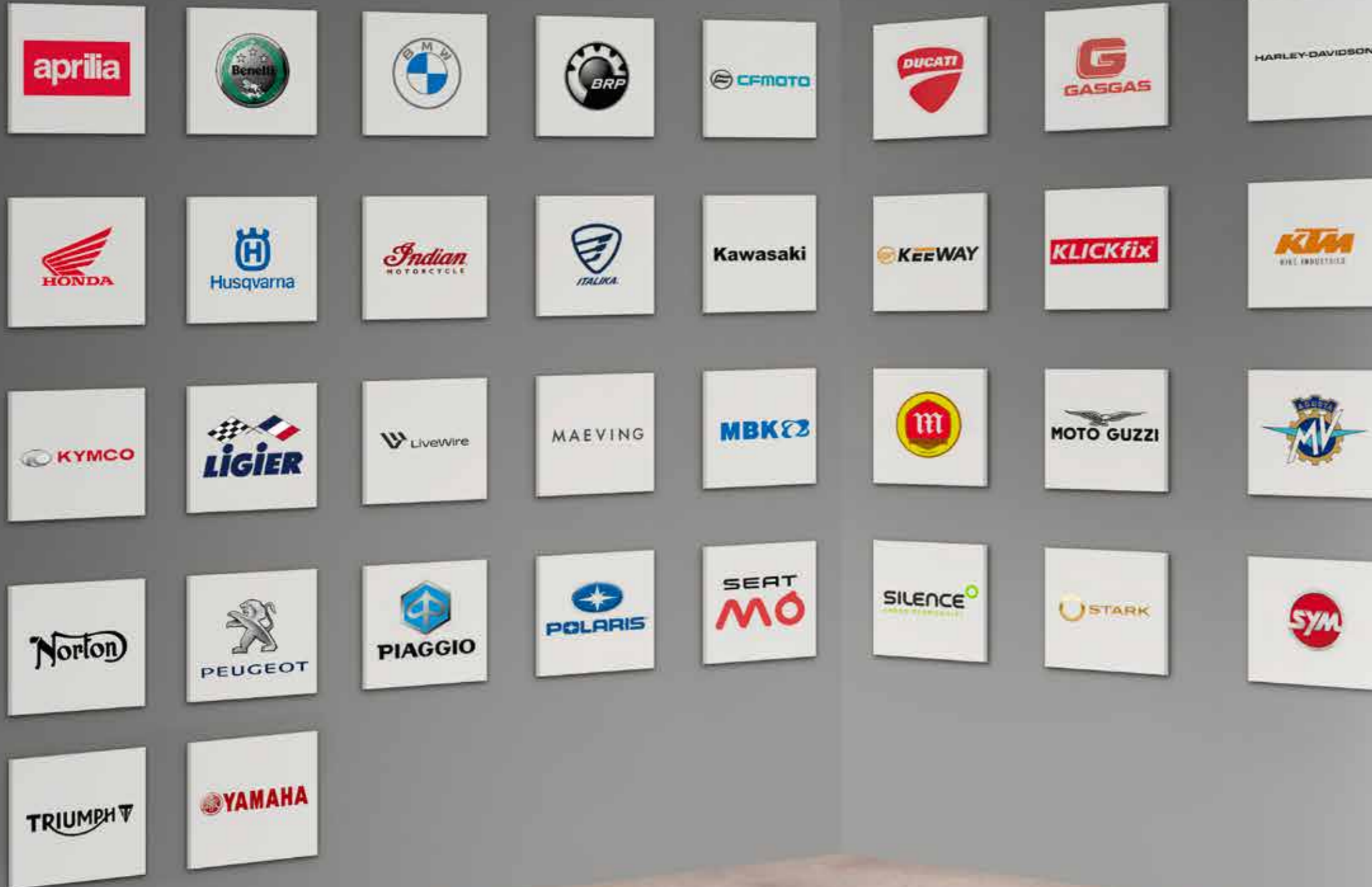

THE COMPANY

SHAD ENGINEERED FOR RIDING

NAD, founded in 1973 and owner of the SHAD brand, is the leading OEM manufacturer of motorcycle seats and cases for all major sector brands. In 2023, we celebrated 50 years of NAD on the market, reaffirming our commitment to innovation.

This year we launched an innovative product in the "Expandable" family: The SH38X, a set of expandable side cases that are adaptable to the latest generation of high-end bikes.

Inspired by the excitement of this anniversary, 2024 is year ONE of the new future-driven era. Thanks to engineering and design, we will continue to provide new solutions in more than 80 countries.

We would like to thank our team of partners, suppliers and, in particular, our customers for the trust and support they have always shown us.



Present in **80** countries

2023 Figures
+5.000 points of sale
+1.000.000 products sold



INNOVATION & DESIGN PROCESS:

ENGINEERED FOR RIDING

DESIGN IN BARCELONA
Since 1973



IDEATION



PROTOTYPING



TESTING



IMPLEMENTATION



3P SYSTEM
2015
PATENTED

3 points fitting kit. Integration, lightness and flexibility.



GERMAN DESIGN AWARD SPECIAL 2017
reddot design award winner 2015
SIDE CASES SH66

X EXPANDABLE
2016
PATENTED

Adjustment of the top case volume. Capacity and Aerodynamics.



reddot design award winner 2017
EXPANDABLE CASES SH66X SH66XX

SHAD TERRA
2018
PATENT PENDING



reddot winner 2021
iF DESIGN AWARD 2021
ABC SPECIAL DESIGN WINNER '22
NEW TERRA 48/37/47/36 ALUMINIUM CASES
NEW TR55 ALUMINIUM TOP CASE

SHAD LOCKS
ENGINEERED FOR RIDING
2021
PATENT PENDING

Set of patents to protect the intellectual property of this product



SHAD TERRA
2022
PATENT PENDING

Practical and secure double locking system



TR40

ABC WINNER '22

CLICK SYSTEM
2023
PATENT PENDING



SH38X
2023
PATENT PENDING



Our strategic approach is based on engineering and design. We kickoff the development process of SHAD products starting with the analysis of market trends and base them according to the needs of our customers.

Our creation process is finalized after an exhaustive period of numerous laboratory tests and prototypes.

Bringing together design and engineering, coupled with 50 years of experience in the sector, has allowed us to:

- Create innovative SHAD products for the main brands in the industry.
- Obtain a set of patented products to technically differentiate us from the rest.
- Win important international design awards.

- Distribute our product to more than 80 countries.
- Participate in exhibitions and fairs in the five continents.
- Be championship sponsors of SUPERBIKES.

For NAD-SHAD, innovation is a way of life and a commitment that we maintain.

QUALITY CASES LAB

The quality of our products is based on continuous improvement, excellence in management and customer satisfaction. We test the product throughout the whole production and development process both in external and our own specialized laboratories, guaranteeing compliance with rigorous quality standards, checking every detail, from the raw material to the final product to be delivered to the customer.



WE ARE
DOING
GREEN

PAINT ADHERENCE TEST



SHAKER TEST

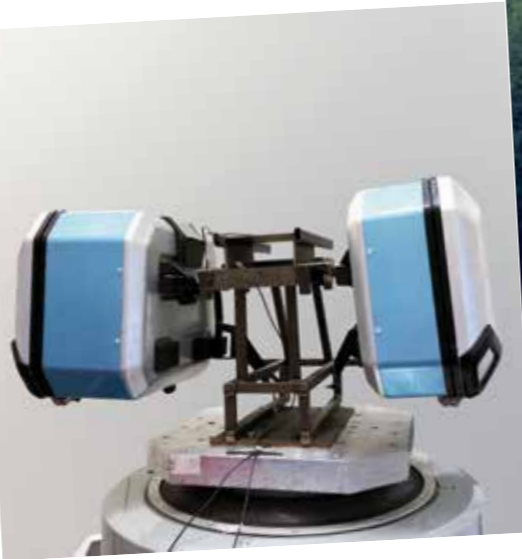

WEATHERING TEST



WATERPROOFNESS TEST



TRACTION TEST



IMPACT TEST



RESOURCE REDUCTION
60% SELF SUSTAINING FACTORIES
1500 TREES PLANTED 🌲🌲🌲



ISO 14001:2015



JUST ENTER
AND SEE HOW



SOCIAL RESPONSIBILITY AND PARTNERSHIPS

PONT DEL DRAGÓ

ENVIRONMENTAL

ISO 14001:2015

tree-nation



INDUSTRY (CLUSTERS)

BcD
Barcelona Centre de Disseny

anesdor
ASSOCIACIÓ NACIONAL DE EMPRESES DEL SECTOR DE COSSIDA

**LIGHT
MOBILITY
CLUSTER**

SOCIAL APPROACH & COMMUNITY



Collaboration with local events and associations

Cruz Roja

unicef



"El Viatge Imaginari de SHAD" is a collection of motorcycle cases and bicycle bags crafted with creativity and diversity.

SHAD seeks to generate social impact and is a speaker at this event for the talent of neurodiverse people or people with motor disabilities.

Since 2020, 180 total hours of workshops and collaborative business actions have been created with the students of the CEE PONT DEL DRAGÓ.

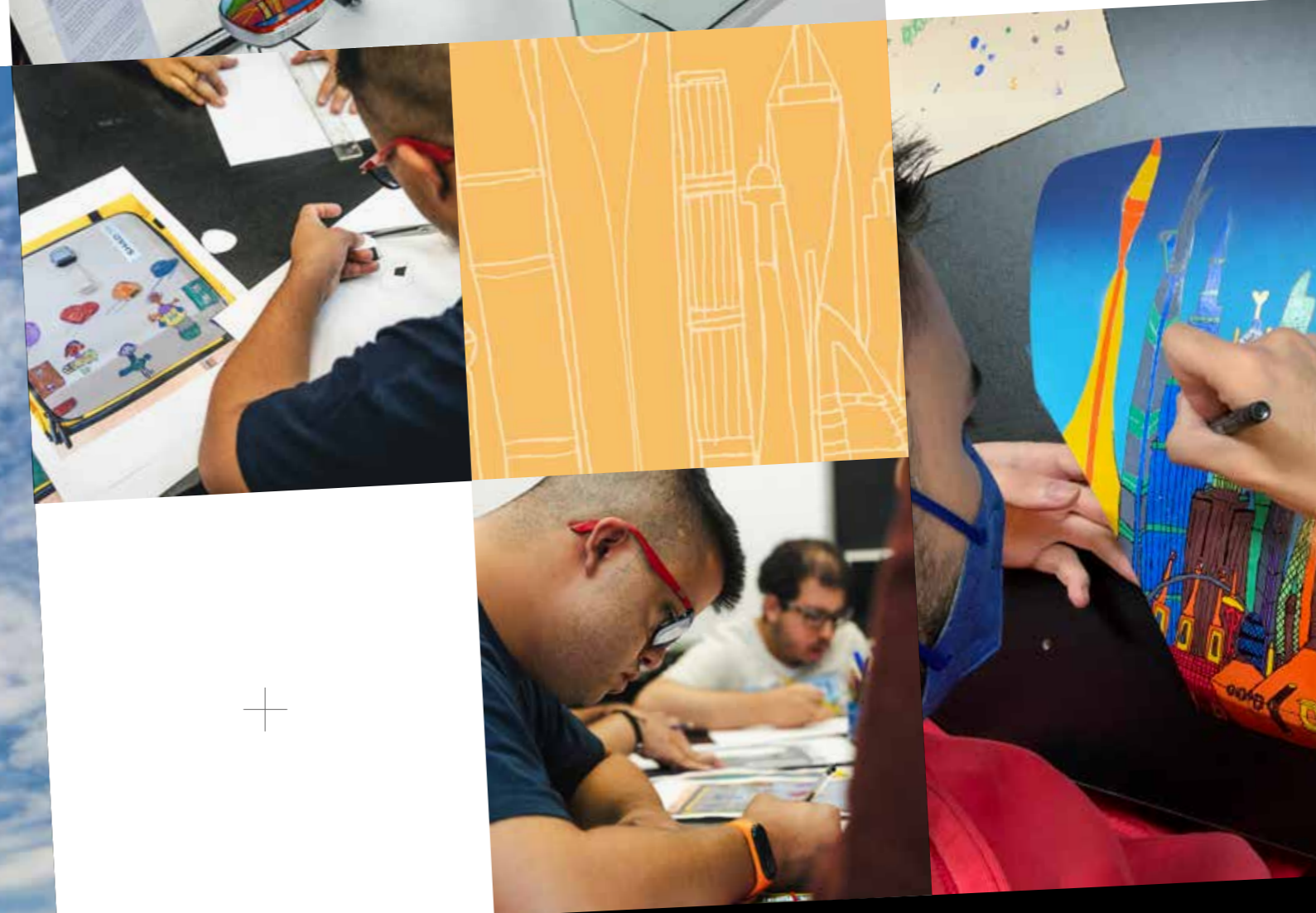

SPONSORSHIPS

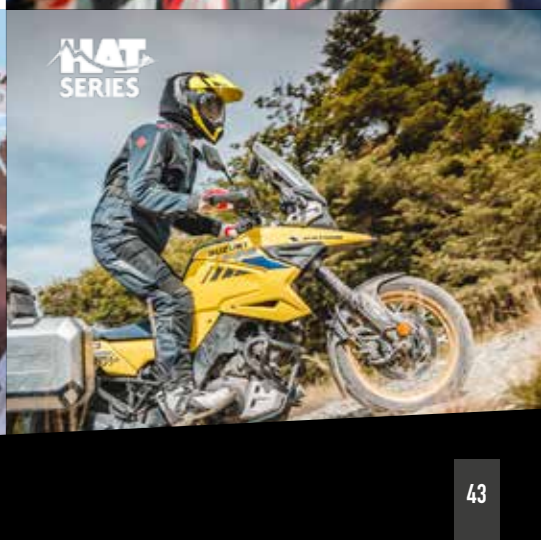
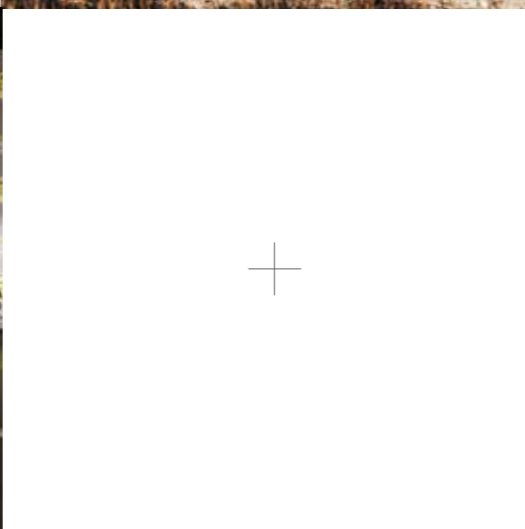
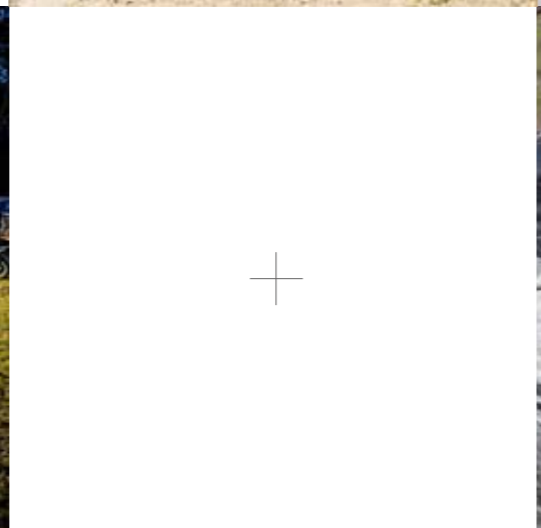

f @SHAD.Motorcycle.Cases
i @Shad_motorcycle_cases
v SHAD Motorcycle cases

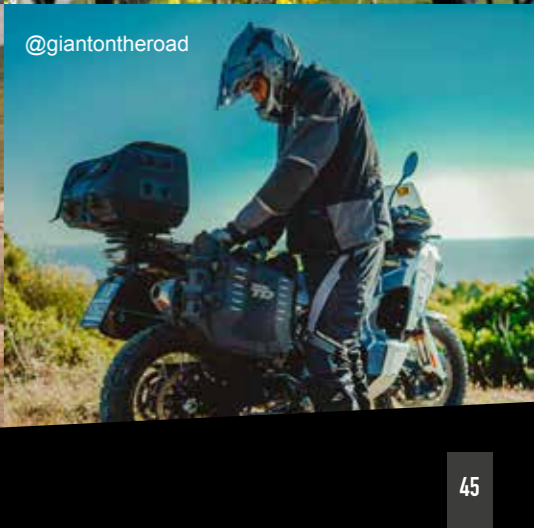

SHAD TERRA

ENGINEERED FOR RIDING



reddot winner 2021



TERRA
48/37/47/36
ALUMINIUM CASES

TR55
ALUMINIUM TOP CASE



THE **LIGHTEST CASE**
IN ITS CATEGORY: **5.4KG**

SET **TR55** | 36 | 47 ALUMINIUM CASES

MORE INFO



SHAD

TERRA

ENGINEERED FOR RIDING



THE **LIGHTEST CASE**
IN ITS CATEGORY: **5.4KG**



TERRA LOCK SYSTEM

PATENT PENDING

AISI 304
STAINLESS STEEL
INTEGRATED LOCK SYSTEM

INTEGRATED CARRYING HANDLE



HARDENED ALUMINIUM ALLOY:
MAXIMUM RESISTANCE &
MINIMUM WEIGHT



LOCK SYSTEM

DOUBLE LOCKING PATENTED SYSTEM: QUICK & EASY TO INSTALL AND REMOVE

1 Key and 1 hand for all operations, place, remove, open and close.



CAPACITY

UP TO TWO HELMET CAPACITY



PREMIUM KEY

+ ANTIDUST PROTECTOR



SIDE OPENING

QUICK AND EASY ACCESS TO STORE YOUR BELONGINGS



DETAILS

EXTRA CARGO HOOKS



STAINLESS STEEL HINGES



RETRACTABLE FOLDING TRAY



INNER CARPET FOR TOP CASES



TR55

ALUMINIUM CASES

Ref. D0TR55100
X57 Y41,8 Z32,2 (cm)

PATENT PENDING



PATENT PENDING



TR55

BLACK EDITION
ALUMINIUM CASES

Ref. D0TR55100B
X57 Y41,8 Z32,2 (cm)



FEATURES



Icon descriptions Page 143

ACCESSORIES

BACKREST
Ref. D0RI75



INNER BAG EXPANDABLE
Top - Side
Ref. X0IB10



REQUIRED

OPTION 1

ALUMINIUM PLATE + SCREWS
D1BTRPA



OPTION 2

ALUMINIUM PLATE + SCREWS
D1BTRPA2



OPTION 3

BIG PLATE + SCREWS
D1B591PA



FEATURES



Icon descriptions Page 143

ACCESSORIES

BACKREST
Ref. D0RI75



INNER BAG EXPANDABLE
Top - Side
Ref. X0IB10



REQUIRED

OPTION 1

ALUMINIUM PLATE + SCREWS
D1BTRPA



OPTION 2

ALUMINIUM PLATE + SCREWS
D1BTRPA2



OPTION 3

BIG PLATE + SCREWS
D1B591PA



TR48

ALUMINIUM CASES
X49,5 Y41,8 Z32,2 (cm)
Ref. D0TR48100



BLACK EDITION
Ref. D0TR48100B



PATENT PENDING



reddot winner 2021



PATENT PENDING



reddot winner 2021



TR37

ALUMINIUM CASES
X49,5 Y41,8 Z25,9 (cm)
Ref. D0TR37100



BLACK EDITION
Ref. D0TR37100B



FEATURES



Icon descriptions Page 143

ACCESSORIES

BACKREST
Ref. D0RI75



INNER BAG EXPANDABLE
Top - Side
Ref. X0IB47



REQUIRED

OPTION 1

ALUMINIUM PLATE + SCREWS
D1BTRPA



OPTION 2

ALUMINIUM PLATE + SCREWS
D1BTRPA2



OPTION 3

BIG PLATE + SCREWS
D1B591PA



FEATURES



Icon descriptions Page 143

ACCESSORIES

BACKREST
Ref. D0RI75



INNER BAG EXPANDABLE
Top - Side
Ref. X0IB47



REQUIRED

OPTION 1

ALUMINIUM PLATE + SCREWS
D1BTRPA



OPTION 2

ALUMINIUM PLATE + SCREWS
D1BTRPA2



OPTION 3

BIG PLATE + SCREWS
D1B591PA



TR47L

ALUMINIUM CASES
X49,5 Y41,8 Z34,5 (cm)
Ref. LEFT D0TR47100L



BLACK EDITION
Ref. LEFT D0TR47100LB



PATENT PENDING



reddot winner 2021



PATENT PENDING



reddot winner 2021



TR47R

ALUMINIUM CASES
X49,5 Y41,8 Z34,5 (cm)
Ref. RIGHT D0TR47100R



BLACK EDITION
Ref. RIGHT D0TR47100RB



FEATURES



Icon descriptions Page 143

ACCESSORIES

OPTIONAL INNER MESH
FOR SIDE CASE
Ref. X0TR01



RETRACTABLE TRAY
INCLUDED

OPTIONAL INNER BAG
INNER BAG / EXPANDABLE
Ref. TOP - SIDE X0IB47

REQUIRED

LOCK CYLINDERS + KEYS

NOT INCLUDED
REF. D1TRBOR



WARNING! ⚠

LOCK CYLINDER +
KEYS NOT INCLUDED

FEATURES



Icon descriptions Page 143

ACCESSORIES



RETRACTABLE TRAY
INCLUDED

OPTIONAL INNER BAG
INNER BAG / EXPANDABLE
Ref. TOP - SIDE X0IB47

INCLUDED

INNER MESH

LOCK CYLINDERS + KEYS



TR36L

ALUMINIUM CASES

X49,5 Y41,8 Z28,2 (cm)
Ref. LEFT D0TR36100L



BLACK EDITION
Ref. LEFT D0TR36100LB



PATENT PENDING



reddot winner 2021



PATENT PENDING



reddot winner 2021



TR36R

ALUMINIUM CASES

X49,5 Y41,8 Z28,2 (cm)
Ref. RIGHT D0TR36100R



BLACK EDITION
Ref. RIGHT D0TR36100RB



FEATURES



Icon descriptions Page 143

ACCESSORIES

OPTIONAL INNER MESH
FOR SIDE CASE
Ref. X0TR01



RETRACTABLE TRAY
INCLUDED

OPTIONAL INNER BAG
INNER BAG / EXPANDABLE
Ref. TOP - SIDE X0IB47



REQUIRED

LOCK CYLINDERS + KEYS

NOT INCLUDED
REF. D1TRBOR



WARNING! ⚠

LOCK CYLINDER + KEYS NOT INCLUDED

FEATURES



Icon descriptions Page 143

ACCESSORIES



RETRACTABLE TRAY
INCLUDED

OPTIONAL INNER BAG
INNER BAG / EXPANDABLE
Ref. TOP - SIDE X0IB47



INCLUDED

INNER MESH



LOCK CYLINDERS + KEYS



HOW TO BUY YOUR TERRA CASE

1

TOP CASE

CHOOSE YOUR TERRA CASE / **TR37** | **TR48** | **TR55**



2

CHOOSE YOUR MOUNTING PLATE

OPTION 1

ALUMINIUM PLATE + SCREWS

D1BTRPA



OPTION 2

ALUMINIUM PLATE + SCREWS

D1BTRPA2



OPTION 3

BIG PLATE + SCREWS

D1B591PA



3

CHOOSE YOUR TOP MASTER



CHECK BIKE COMPATIBILITY
WWW.SHAD.ES

!
WATCH OUT
EXHAUST PIPE
SIDE
Always TR36



CHECK BIKE COMPATIBILITY
WWW.SHAD.ES

SIDE CASE

CHOOSE YOUR TERRA RIGHT CASE **TR47R** | **TR36R**

1



2

CHOOSE YOUR TERRA LEFT CASE **TR36L** | **TR47L**



3

CHOOSE YOUR 4P SYSTEM | **4P SYSTEM**

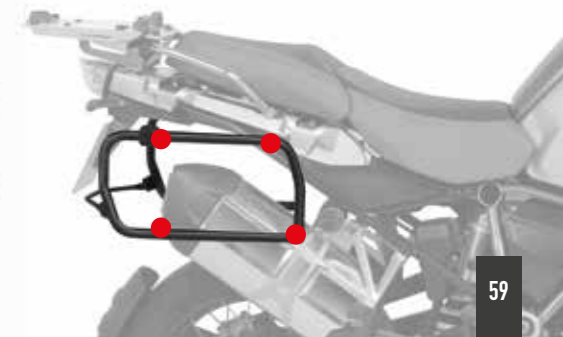

TOP CASES



SH47 | TOP CASE

THE MOST DESIGN - AWARDED
MOTORCYCLE CASES

EXPANDABLE SYSTEM

PATENTED



EXPANDABILITY **30%**

L / 46L

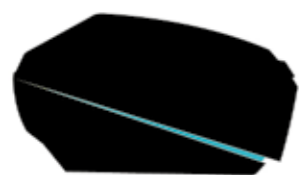

XL / 52L



XXL / 58L



DESIGNED & MADE IN BARCELONA
Since 1973

 **reddot design award**
winner 2017



EXPANDABLE / TOP CASE SH58X / SH59X

MOTODYNAMICS



EASY TO EXPAND

3 POSITIONS:



FEATURES

STRUCTURAL FRAME



L XXL

Transform in seconds from a large case to a small aerodynamic one

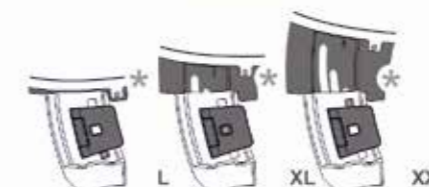
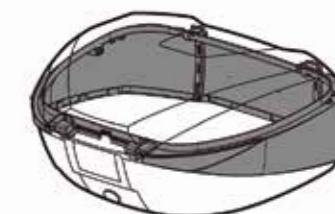
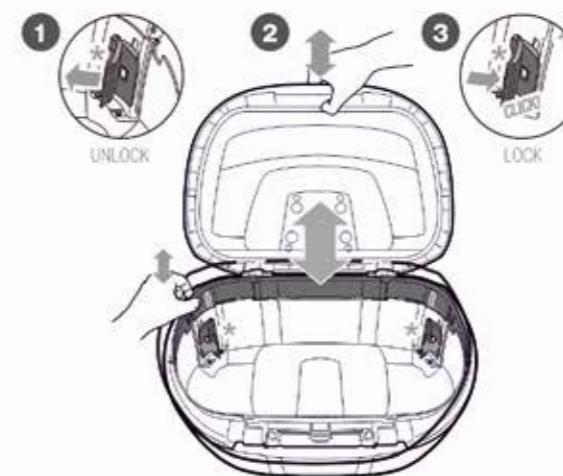

SH59X

X48 Y61 Z27/29/31.5 (cm)
Ref. D0B59200

PATENTED



reddot design award
winner 2017

EXPANDABLE CASE MAXIMUM VERSATILITY

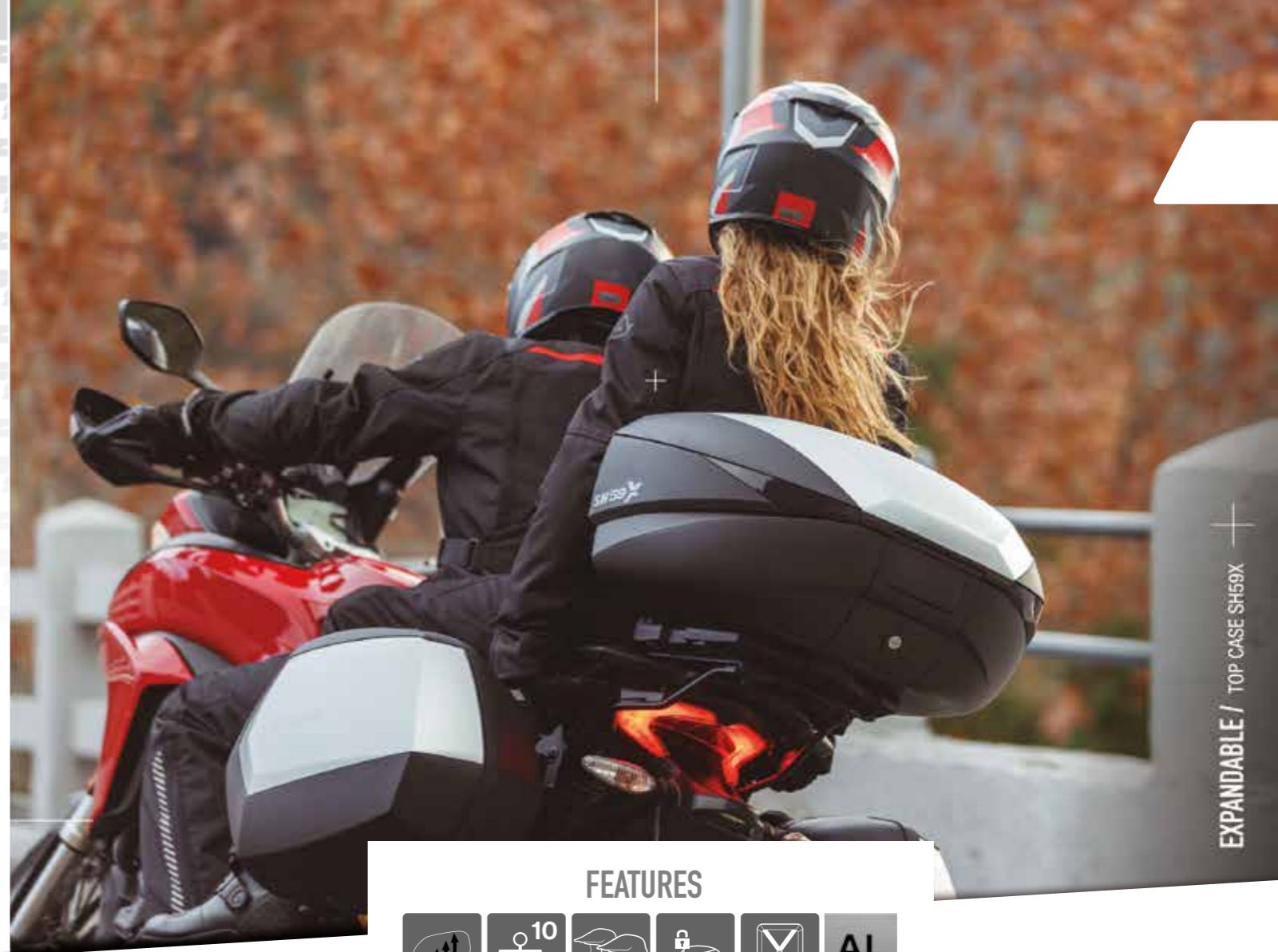

EXPANDABLE / TOP CASE SH59X

FEATURES



Icon descriptions Page 143

INCLUDED

STANDARD PLATE + SCREWS PREMIUM SMART LOCK



ACCESSORIES

BACKREST
Ref. D0RI80



INNER BAG
Ref. X0IB59



X 21/28 Y 50 Z 39 (cm)
EXPANDABLE

ALUMINIUM PLATE +
SCREWS
Ref. D1BTRPA



ALUMINIUM PLATE +
SCREWS
Ref. D1BTRPA2



BRAKE LIGHT
Ref. D0B29KL



LED

SH58X

X48 Y61 Z27/29/31.5 (cm)
Ref. D0B58206



PATENTED



INCLUDED
FREE COVER
CARBON LOOK



reddot design award
winner 2017

EXPANDABLE CASE MAXIMUM VERSATILITY

CARBON
Ref. D0B58206



NEW TITANIUM
Ref. D0B58206 +
D1B58E15



WHITE
Ref. D0B58206 +
D1B58E08



BLACK METAL
Ref. D0B58206 +
D1B58E21



EXPANDABLE / TOP CASE SH58X

FEATURES



Icon descriptions Page 143

INCLUDED

STANDARD PLATE + SCREWS



PREMIUM SMART LOCK



ACCESSORIES

BACKREST
Ref. D0RI80



INNER BAG
Ref. X0IB59



X 21/28 Y 50 Z 39 (cm)
EXPANDABLE

ALUMINIUM PLATE + SCREWS
Ref. D1BTRPA



ALUMINIUM PLATE + SCREWS
Ref. D1BTRPA2



BRAKE LIGHT
Ref. D0B29KL



LED

SH50

X46 Y60 Z32 (cm)
Ref. D0B5000



BLACK
Ref. D0B5000



BLUE
Ref. D0B5000 + D1B50E01



SILVER
Ref. D0B5000 + D1B50E05



WHITE
Ref. D0B5000 + D1B50E08



UNPAINTED COVER
Ref. D1B50ER



TOP CASE / SH50

FEATURES



Icon descriptions Page 143

INCLUDED

STANDARD PLATE + SCREWS



BACKREST



ACCESSORIES

INNER BAG
Ref. X0IB00



X 35 Y 50 Z 21 (cm)

LUGGAGE RACK
Ref. D0PS00



BRAKE LIGHT
Ref. D0B29KL



LED

SH48

DARK GREY

X46 Y61 Z31 (cm)
The lightest in its range
Ref. D0B48306R



SH48

NEW TITANIUM

X46 Y61 Z31 (cm)
The lightest in its range
Ref. D0B48406R



FEATURES



Icon descriptions Page 143

COLOR COVERS

Ref. D1B48E...

- 08-White
- 06-Carbon
- 17-Dark Grey

NO COVER TOP CASE
Ref. D0B48300

CARBON + BACKREST
Ref. D0B48306R

INCLUDED

STANDARD PLATE + SCREWS

PREMIUM SMART LOCK



ACCESSORIES

BACKREST
Ref. D0RI4800



INNER BAG
Ref. X0IB00



X 35 Y 50 Z 21 (cm)

LUGGAGE RACK
Ref. D0PS00



ALUMINIUM
PLATE + SCREWS
Ref. D1BTRPA



ALUMINIUM
PLATE + SCREWS
Ref. D1BTRPA2



BRAKE LIGHT
Ref. D0B29KL



LED

FEATURES



Icon descriptions Page 143

COLOR COVERS

Ref. D1B48E...

- 08-White
- 06-Carbon
- 15-New titanium

NO COVER TOP CASE
Ref. D0B48400

CARBON + BACKREST
Ref. D0B48406R

INCLUDED

STANDARD PLATE + SCREWS

PREMIUM SMART LOCK



ACCESSORIES

BACKREST
Ref. D0RI4800



INNER BAG
Ref. X0IB00



X 35 Y 50 Z 21 (cm)

LUGGAGE RACK
Ref. D0PS00



ALUMINIUM
PLATE + SCREWS
Ref. D1BTRPA



ALUMINIUM
PLATE + SCREWS
Ref. D1BTRPA2



BRAKE LIGHT
Ref. D0B29KL



LED

SH47

RED

X42 Y57,5 Z31,2 (cm)
Ref. D0B47206



White
Ref. D0B47106



SH46

X42 Y58 Z31 (cm)
Ref. D0B46200



FEATURES



Icon descriptions Page 143

INCLUDED

STANDARD PLATE + SCREWS



ACCESSORIES

INNER BAG
Ref. X0IB00



X 35 Y 50 Z 21 (cm)

BACK REST
Ref. D0RI47





BRAKE LIGHT
Ref. D0B40KL



LED

COLOUR COVERS
Ref. D1B47E...

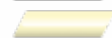
-  08-White
 -  15-New titanium
 -  ER- Unpainted cover
- Ref. D1B47ER

FEATURES



Icon descriptions Page 143

INCLUDED

STANDARD PLATE + SCREWS



ACCESSORIES

BACKREST
Ref. D0RI50



INNER BAG
Ref. X0IB00



X 35 Y 50 Z 21 (cm)

LUGGAGE RACK
Ref. D0PS00



BRAKE LIGHT
Ref. D0B40KL



LED

SH45

X41 Y56.4 Z31.4 (cm)
Ref. D0B45100 + D1B45E05



FEATURES



Icon descriptions Page 143

INCLUDED

STANDARD PLATE + SCREWS



ACCESSORIES

BACKREST
Ref. D0RI60



INNER BAG
Ref. X0IB00



X 35 Y 50 Z 21 (cm)

BRAKE LIGHT
Ref. D0B40KL



LED

No cover top case Ref. D0B45100
COLOUR COVERS
Ref. D1B45E...

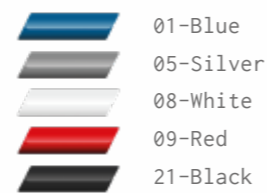

SH44

X43,5 Y55 Z31,5 (cm)
Ref. D0B44100



FEATURES



Icon descriptions Page 143

INCLUDED

STANDARD PLATE + SCREWS



ACCESSORIES

BACKREST
Ref. D0RI60



BRAKE LIGHT
Ref. D0B40KL



LED

INNER BAG
Ref. X0IB00



X 35 Y 50 Z 21 (cm)

SH40

X42.5 Y49.5 Z29.6 (cm)
Ref.: D0B40100+D1B40E08



Alu look top case.
Ref. D0B40200



FEATURES



Icon descriptions Page 143

INCLUDED

STANDARD PLATE + SCREWS



ACCESSORIES

BACKREST
Ref. D0RI60





BRAKE LIGHT
Ref. D0B40KL



LED

No cover top case Ref. D0B40100
COLOUR COVERS
Ref. D1B40E...

-  01-Blue
-  05-Silver
-  08-White
-  09-Red
-  21-Black

SH40

CARGO

X42.5 Y49.2 Z32.5 (cm)
Ref. D0B40199



FEATURES



Icon descriptions Page 143

INCLUDED

STANDARD PLATE + SCREWS



ACCESSORIES

BACKREST
Ref. D0RI60



BRAKE LIGHT
Ref. D0B40KL



LED

SH39

X43 Y51 Z32 (cm)
Ref. D0B39106



FEATURES



Icon descriptions Page 143

INCLUDED

STANDARD PLATE + SCREWS



ACCESSORIES

BACKREST
Ref. D0RI3900





BRAKE LIGHT
Ref. D0B40KL



LED

No cover top case Ref. D0B39100
Carbon cover top case Ref. D0B39106
COLOUR COVERS
Ref. D1B39E...

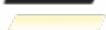
-  08-White
-  15-New titanium
-  21-Black
-  Unpainted cover
Ref. D1B39ER

SH37

X40 Y49 Z31 (cm)
Ref. D0B37100



FEATURES



Icon descriptions Page 143

INCLUDED

STANDARD PLATE + SCREWS



ACCESSORIES

BACKREST
Ref. D0RI160





BRAKE LIGHT
Ref. D0B29KL



LED

No cover top case Ref. D0B37100
COLOUR COVERS
Ref. D1B37E...

-  09-Red
-  Unpainted cover
Ref. D1B37ER

SH34

X42 Y43 Z31 (cm)
Ref. D0B34106



FEATURES



Icon descriptions Page 143

INCLUDED

SMALL PLATE + SCREWS



ACCESSORIES

BACKREST
Ref. D0RI40



BRAKE LIGHT
Ref. D0B29KL



LED

SH33

X42 Y43 Z31 (cm)
Ref. D0B33200+D1B33E21



FEATURES



Icon descriptions Page 143

INCLUDED

SMALL PLATE + SCREWS



ACCESSORIES

BACKREST
Ref. D0RI40





BRAKE LIGHT
Ref. D0B29KL



LED

No cover top case Ref. D0B33200
COLOUR COVERS
Ref. D1B33E8...

-  01-Blue
-  08-White
-  09-Red
-  15-New titanium
-  21-Black
-  Unpainted cover Ref. D1B33E800

SH29

X38 Y40 Z30 (cm)
Ref. D0B29100



FEATURES



Icon descriptions Page 143

INCLUDED

SMALL PLATE + SCREWS



ACCESSORIES

BACKREST
Ref. D0RI40



BRAKE LIGHT
Ref. D0B29KL



LED

No cover top case Ref. D0B29100
COVER COLOURS
Ref. D1B29E...

-  01-Blue
-  08-White
-  09-Red
-  21-Black
-  Unpainted cover Ref. D1B29ER

SH26

X40.5 Y40 Z28.2 (cm)
Ref. D0B26100



FEATURES



Icon descriptions Page 143

INCLUDED

SMALL PLATE + SCREWS



ACCESSORIES

BRAKE LIGHT
Ref. D0B29KL



LED

SIDE CASES



reddot design award
winner 2017



GERMAN
DESIGN
AWARD
SPECIAL
2017



+ SIDE CASES / SH38X

NEW SH38X / EXPANDABLE

X51 Y27/34 Z39 (cm)
Ref. D0B38200

PATENT PENDING



MODULAR HELMET 1 CAPACITY



ACCESSORIES

4P FITTING ADAPTER
Ref. 204632R



INCLUDED

EXTRA LOCK FOR
YOU TOP CASE



CHECK BIKE COMPATIBILITY
WWW.SHAD.ES



SH38X / EXPANDABLE

FEATURES



Icon descriptions Page 143

ACCESSORIES

EXPANDABLE INNER BAG
Ref. X0IB38



EXPANDED / 40%



ERGONOMY

RETRACTABLE AND INTEGRATED
CARRYING HANDLE







NEW SH38X CARBON / EXPANDABLE

X51 Y27/34 Z39 (cm)
Ref. D0B38106

PATENT PENDING



COLOUR COVERS
Ref. D1B38E...

-  08-White
-  21-Black
-  06- Carbon
-  ER.- Unpainted cover

MODULAR HELMET 1 CAPACITY



ACCESSORIES

4P FITTING ADAPTER
Ref. 204632R



INCLUDED
EXTRA LOCK FOR
YOU TOP CASE



CHECK BIKE COMPATIBILITY
WWW.SHAD.ES



SH38X / EXPANDABLE

FEATURES



Icon descriptions Page 143

ACCESSORIES

EXPANDABLE INNER BAG
Ref. X0IB38



EXPANDED / 40%



ERGONOMY

RETRACTABLE AND INTEGRATED
CARRYING HANDLE



SH36

X51 Y33 Z38 (cm)
The lightest in its range
Ref. D0B36200



reddot design award
winner 2015



Modular Helmet XXL
Retractable Handle
Elastic strap
Structural frame
Inner tray



THE MOST DESIGN-AWARDED
SIDE CASES SH36



CHECK BIKE COMPATIBILITY
WWW.SHAD.ES



SIDE CASE / SET SH36 / SH58

FEATURES

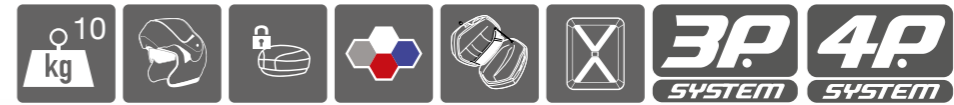

Icon descriptions Page 143

INCLUDED

RETRACTABLE HANDLE



EXTRA LOCK FOR
YOUR TOP CASE



PREMIUM
LOCK - 1 HAND USE



ACCESSORIES

INNER BAG
Ref. X0IB36



RED REFLECTION
Ref. D1B36CAR



CARBON
Ref. D0B36200



WHITE
Ref. D0B36200+D1B36E08



NEW TITANIUM
Ref. D0B36200+D1B36E15



BLACK METAL
Ref. D0B36200+D1B36E21



SH35

X51 Y30 Z38 (cm)
Ref. D0B35200



Retractable handle
Elastic strap
Structural frame
Inner tray



CHECK BIKE COMPATIBILITY
WWW.SHAD.ES



SIDE CASE / SET SH35 / SH59X

FEATURES



Icon descriptions Page 143

INCLUDED

RETRACTABLE HANDLE



EXTRA LOCK FOR YOUR TOP CASE



PREMIUM
LOCK - 1 HAND USE



ACCESSORIES

INNER BAG
Ref. X0IB36



X 28 Y 41 Z 31 (cm)

SH23

X49 Y26 Z35 (cm)
Ref. D0B23100



CHECK BIKE COMPATIBILITY
WWW.SHAD.ES



+ SET / SH23 / SH34

FEATURES

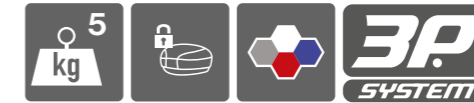

Icon descriptions Page 143

INCLUDED

EXTRA LOCK FOR YOUR TOP CASE



BLACK
Ref. D0B23100

WHITE
Ref. D0B23100 +
D1B23E08

NEW TITANIUM
Ref. D0B23100 +
D1B23E15

ALU LOOK COVER
INCLUDED
Ref. D0B23200W



ACCESSORIES FOR CASES

BACKRESTS



INNER BAGS



UPPER RACK



COLOUR COVERS



BRAKE LIGHTS



INNER MESH



TOP CASES

	Backrest	Inner bags	Upper rack	Brake lights	Colour covers*
TR55	D0RI75	X0IB10			
TR48/TR48B	D0RI75	X0IB47			
TR37/TR37B	D0RI75	X0IB47			
SH59X	D0RI80	X0IB59		D0B29KL	
SH58X	D0RI80	X0IB59		D0B29KL	■ ■ ■
SH50	INCLUDED	X0IB00	D0PS00	D0B29KL	■ ■ ■ ■ ■
SH48 Dark Grey	D0RI4800	X0IB00	D0PS00	D0B29KL	■ ■ ■ ■ ■
SH48 New Titanium	D0RI4800	X0IB00	D0PS00	D0B29KL	■ ■ ■ ■ ■
SH47 Red	D0RI47	X0IB00		D0B40KL	■ ■ ■ ■ ■
SH47 White	D0RI47	X0IB00		D0B40KL	■ ■ ■ ■ ■
SH46	D0RI50	X0IB00	D0PS00	D0B40KL	■ ■ ■ ■ ■
SH45	D0RI60	X0IB00		D0B40KL	■ ■ ■ ■ ■
SH44	D0RI60	X0IB00		D0B40KL	■ ■ ■ ■ ■
SH40	D0RI60			D0B40KL	■ ■ ■ ■ ■
SH40 CARGO	D0RI60			D0B40KL	■ ■ ■ ■ ■
SH39	D0RI3900			D0B40KL	■ ■ ■ ■ ■
SH37	D0RI60			D0B29KL	■ ■ ■ ■ ■
SH34	D0RI40			D0B29KL	■ ■ ■ ■ ■
SH33	D0RI40			D0B29KL	■ ■ ■ ■ ■
SH29	D0RI40			D0B29KL	■ ■ ■ ■ ■
SH26				D0B29KL	■ ■ ■ ■ ■

SIDE CASES

	Inner bags	Inner mesh	Colour Covers*
TR47/TR47B	X0IB47	X0TR01	
TR36/TR36B	X0IB47	X0TR01	
SH38X	X0IB38		■ ■ ■
SH36	X0IB36		■ ■ ■ ■ ■
SH35	X0IB36		■ ■ ■ ■ ■
SH23			■ ■ ■ ■ ■

* PLEASE CHECK EVERY CASE CATALOGUE PAGE TO SEE REFERENCES

■ Blue ■ Silver ■ Carbon ■ White ■ Red ■ New titanium ■ Dark Grey ■ Black □ Non painted cover



FITTING KITS / TOP CASES - SIDE CASES - BAGS OTHERS

FITTING KITS

TOP CASES



SIDE CASES



SIDE BAG HOLDER

SIDE BAG HOLDER SR

BAGS / OTHERS



BACKRESTS



Scooter



Custom



CHECK BIKE COMPATIBILITY
WWW.SHAD.ES



FITTING KIT / 4P - SIDE CASES



FITTING KIT / 3P - SIDE CASES

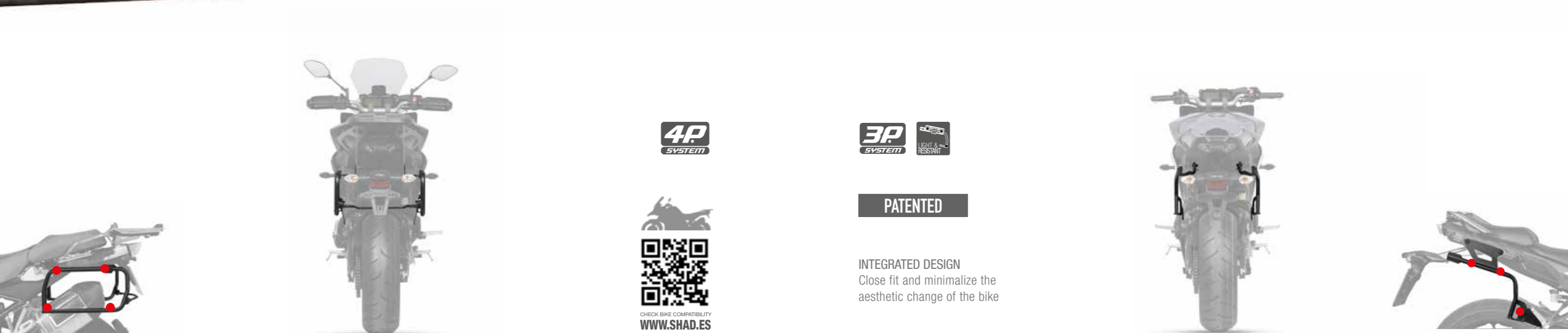

CHECK BIKE COMPATIBILITY
WWW.SHAD.ES

PATENTED

INTEGRATED DESIGN
Close fit and minimize the aesthetic change of the bike

DURABILITY
Designed for hard use. Transversal support to increase strength between the two cases.

MATERIAL
20mm Steel frame. Biggest in the market. Metallic powder coated paint.

COMPATIBLE WITH:
TR47L & TR47R, TR47L & TR47R BLACK EDITION, TR36L & TR36R, TR36L & TR36R BLACK EDITION, SH38X, SH36, SH35, TR40, TR30.

LIGHTNESS
Nearly no change in the bike's center of gravity, hence improving safety.

MATERIAL
20mm Steel frame. Biggest in the market. Metallic powder coated paint.

COMPATIBLE WITH:
SH38X, SH36, SH35, SH23, TR40, TR30.

PATENTED
3 point to fit the case on the bike.

TOP FITTING

TOP MASTER



CHECK BIKE COMPATIBILITY
WWW.SHAD.ES



MOUNTING PLATES



S

Small Plate
(INCLUDED)
SH26/SH29/SH33/SH34
Ref. D1B29PAR



M

Medium Plate
(INCLUDED)
SH39/SH40/SH44/SH45/
SH46/SH47
Ref. D1B40PAR



B

Big Plate
SH59X/SH58X/SH50/SH48
(INCLUDED)
TR55/TR48/TR37
(not INCLUDED)
Ref. D1B591PA



A

Aluminium Plates
(not included)
SH59X/SH58X/SH50/SH48/TR55/
TR50/TR48/TR37
Aluminium Plate.- D1BTRPA
Black Aluminium Plate.- D1BTRPA2

SIDE BAG HOLDER

Side Bag Holder:
SL58/E48/SW42



Universal Side Holder
SL58/E48/SW42
Ref. D0SS5E



Side Bag Holder SR:
E48SR/SR38



ENGINEERED FOR RIDING



PATENT PENDING

NEW CLICK SYSTEM / DESIGN AND FUNCTIONALITY

BACKRESTS

SCOOTER

STEP 1. Backrest
Choose your favorite color

Ref. D0RP00 Ref. D0RP08 Ref. D0RP05 Ref. D0RP00N



STEP 2: Fitting kit
Look for your motorcycle model

CUSTOM Sissybar

STEP 1.
Backrest



STEP 2.
Top case Rack



Chromed
ref. NADTN Black
ref. NADTNN

COMFORT SEATS

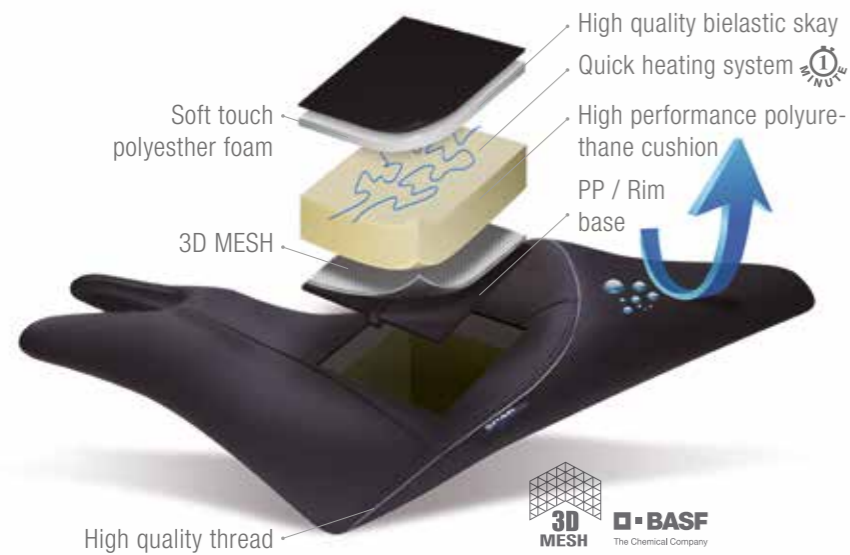

SHAD
style

High quality bielastic skay
Resistant to:



YAMAHA T-MAX

Model and year

T-MAX 500 (2008-13)
T-MAX 530 (2014-16)



Ref. SHY0T5320
Black, with white seams

KAWASAKI Z750-1000

Model and year

Z750 (2007-13)
Z1000 (2007-09)



Ref. SHK0Z1000C
Black, with dark, grey seams

YAMAHA FZ6

Model and year

FAZER FZ6 600 (2004-10)



Ref. SHY0F7000
Black, with grey seams

PIAGGIO MP3

Model and year

MP3 RL (2007-12) · MP3 RST 125-250-100 (2009-12) · MP3 LT 250-400 (2009-13)
MP3 500 SPORT/BUSINESS (2011-13)



Ref. SHV0M2320
Black-white, grey-blue seams

YAMAHA MT-09

Model and year

MT-09 (2013-18)



Ref. SHY0M9300
Black-grey, with grey seams

BAGS

TERRA SPORT TOURING CAFE RACER ADVENTURE



E48SR / HARD SHELL SADDLE BAGS

TR40

X40 Y25 Z38 (cm)
Ref. X0TR401

PATENT PENDING



TR40 / ADVENTURE SADDLE BAGS

FEATURES



Icon descriptions Page 143

INCLUDED

DRY BAG + BAG HOLDER

FUEL BOTTLE HARNESS



DETAILS

4 SIDE + 2 TOP DURAFLEX CAMBUCKLES: ADJUST THE BAG TO THE SIZE OF THE LOAD

AIRCRAFT GRADE ANODIZED ALUMINUM BUCKLES

REFLECTIVE ELEMENTS

2 MOLLE SYSTEM GRIDS PER BAG



PATENT PENDING

DOUBLE LOCKING SYSTEM

QUICK MOUNTING & QUICK LOCKING: ONE KEY TO OPEN AND RELEASE. LOCK ACCESS TO INSIDE OF THE BAG



PREMIUM LOCK

+ ANTIDUST PROTECTOR



ULTRA DURABLE MATERIAL

1500H UV PROTECTION

ABRASION RESISTANCE 50.000 CYCLES

REINFORCED STITCHING

REINFORCED BOTTOM STRUCTURE

WATERPROOF

DOUBLE ROLL BAGS: OUTER BAG AND INCLUDED INNER BAG ENSURES WATERPROOFNESS



INSTALLATION TO 3P AND 4P SYSTEM

HEAVY DUTY 4P & 3P MOUNTING PLATE MADE OF POLYAMIDE 30% GLASS FIBER



SIDE FITTING not included

TR30 | WATERPROOF

X40 Y23 Z38 (cm)
Ref. X0TR30

PATENT PENDING



DETAILS

4 SIDE + 2 TOP BUCKLES:
ADJUST THE BAG TO THE SIZE
OF THE LOAD



AIRCRAFT GRADE ANODIZED
ALUMINUM BUCKLES



REFLECTIVE ELEMENTS



EXTRA LOAD



TR30 | WATERPROOF ADVENTURE SADDLE BAGS

FEATURES



Icon descriptions Page 143

PATENT PENDING

DOUBLE LOCKING SYSTEM

QUICK MOUNTING & QUICK LOCKING:
ONE KEY TO OPEN AND RELEASE. LOCK
ACCESS TO INSIDE OF THE BAG

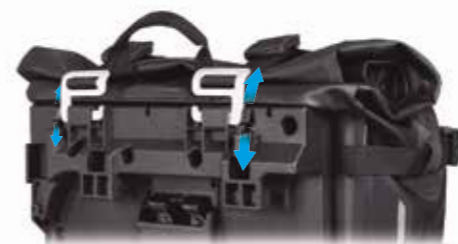

PREMIUM LOCK

+ ANTIDUST PROTECTOR



ULTRA DURABLE MATERIAL

- 1500H UV PROTECTION
- ABRASION RESISTANCE 25.000 CYCLES
- REINFORCED STITCHING
- REINFORCED BOTTOM STRUCTURE

WATERPROOF

DOUBLE ROLL BAGS



INSTALLATION TO 3P AND 4P SYSTEM

HEAVY DUTY 4P & 3P MOUNTING PLATE
MADE OF POLYAMIDE 30% GLASS FIBER



SIDE FITTING
not included

TR50

X35 Y57 Z31,5
Ref. X0TR50



INCLUDED

SHOULDER STRAP



RAIN COVER



DRY BAG + BAG HOLDER
Ref. X1TR03



BOTTLE HARNESS
Ref. X1TR05



DETAILS

2 MOLLE SYSTEM GRIDS



REFLECTIVE ELEMENTS



PREMIUM LOCK +
ANTIDUST PROTECTOR



ALL STRAP ENDS HAVE
CLOSURES.



ACCESSORIES



FEATURES



Icon descriptions Page 143

CAPACITY

2 FULL FACE HELMETS



LOCKING SYSTEM

QUICK MOUNTING ON BASE PLATE



ULTRA DURABLE MATERIAL

1000H UV PROTECTION

REINFORCED STITCHING

REINFORCED BOTTOM STRUCTURE

REQUIRED

OPTION 1
ALUMINIUM PLATE + SCREWS
D1BTRPA



OPTION 2
ALUMINIUM PLATE + SCREWS
D1BTRPA2



OPTION 3
BIG PLATE + SCREWS
D1B591PA



CHECK BIKE COMPATIBILITY
WWW.SHAD.ES

TR15

X38 Y29 Z23 (cm)
STANDARD VERSION
Ref. X0TR15C

LOCKABLE VERSION
Ref. X0TR15CL



FEATURES



Icon descriptions Page 143

INCLUDED

SHOULDER STRAP



RAIN COVER



REQUIRED

CLICK SYSTEM FITTING KIT



ACCESSORIES

LOCK MECHANISM + KEYS
Ref. X1SESTLR



PADLOCK ZIPPERS



PUSH BUTTON RELEASE SYSTEM



ULTRA DURABLE MATERIAL

- 1000H UV PROTECTION
- POLYESTER 900D, PVC COATING
- PU + HYPALON.

REFLECTIVE ELEMENTS



ADJUSTABLE TO TANK'S SHAPE



LOCKING MECHANISM TR15CL



CLICK SYSTEM



CHECK BIKE COMPATIBILITY
WWW.SHAD.ES

CLICK
SYSTEM

PATENT PENDING

ENGINEERED FOR RIDING



① COMBINATION LOCK
Zippered main compartment
For: Expandable/Double lock versions



② LOCKING MECHANISM
For: Expandable / Double lock / Lockable versions



③ PUSH BUTTON
Release system



④ EXPANDABILITY
For: Pro versions



E03

X 23 Y 21 Z 11 cm



CLICK
SYSTEM



* Pro Version

E09

X 30 Y 24,5 Z 14 cm.



CLICK
SYSTEM



* Pro Version

	STANDARD VERSION	LOCKABLE VERSION	DOUBLE LOCK VERSION	DOUBLE LOCK + EXPANDABLE PRO VERSIO	LOCKING SYSTEM ACC.	COMBINATION LOCK ACC.
E03	X0SE03C	-	-	X0SE03CLP	X1SESTLR	X1SESTCL
E09	X0SE09C X0SE09CM	-	X0SE09CLD	X0SE09CLP	X1SESTLR	X1SESTCL

E48SR

HARD SHELL SADDLE BAGS

X 45 Y 27 Z 29 (cm)

Ref. X0SE48SR



INCLUDED

INNER BAG



KEY LOCK MECHANISM



COMBINATION LOCK



INTEGRATED CARRYING HANDLE



E48SR / HARD SHELL SADDLE BAGS

FEATURES



Icon descriptions Page 143

INSTALLATION ON SIDE BAG HOLDER SR

Strong and light fitting made
of polyamide and glass fibre



E48

EXPANDABLE SADDLE BAGS

X 47 Y 24/30 Z 29 (cm)
Ref. X0SE481



SL58

EXPANDABLE SADDLE BAGS

X47 Y18/21 Z29 (cm)
Ref. X0SL58



E04

SMALL TANK BAG

X29 Y26 Z10 (cm)
Ref. X0SE04



Accessories (pag. 129)

SL20F

TANK BAG
X40 Y30 Z18/21 (cm)
Ref. X0SL20F



SL12M

SMALL TANK BAG
X30 Y19 Z10 (cm)
Ref. X0SL12M



SC25

SCOOTER BAG
X38 Y27 Z26 (cm)
Ref. X0SC25



Accessories (pag. 129)

SL86

BACKPACK

X30 Y27 Z45 (cm)
Ref. X0SL86



SL03

WAIST BAG

X9 Y23 Z16 (cm)
Ref. X0SL03



SL05

BIG LEG BAG

X11 Y25 Z15 (cm)
Ref. X0SL05



SL01

TOLL PASS POUCH

X4 Y6 Z10 (cm)
Ref. X0SL01



SL04

SMALL LEG BAG

X3 Y26 Z13 (cm)
Ref. X0SL04



WARNING!

MINIMUM
DISTANCE
10 CM



SHAD
ENGINEERED FOR RIDING
SR

Genuine
SINCE 1973

WWW.SHAD.ES



SR38 SR18 / CAFE RACER BAGS

FEATURES



REF: X0SR3821
SADDLE BAG SR38 BLACK

REF: X0SR18
TANK BAG SR18

REF: X0SR38
SADDLE BAG SR38

SR18

TANK BAG

X36 Y18 Z15(cm)
Ref. X0SR18



SR38 BLACK

SADDLE BAG

X24 Y15 Z34 (cm)
Ref. X0SR3821



! CHECK FOR MOTORCYCLE
SPECIFIC FITTING KIT
WWW.SHAD.ES



SR38

SADDLE BAG

X24 Y15 Z34 (cm)
Ref. X0SR38



! CHECK FOR MOTORCYCLE
SPECIFIC FITTING KIT
WWW.SHAD.ES



WATERPROOF



WATERPROOF BAGS / SET SW45 / 42 / 38 / 23

FEATURES



- HIGH QUALITY
- EXTREME TEMPERATURES
- HIGH RESISTANCE
- UV PROTECTION

WATERPROOF

SEAMLESS HIGH FREQUENCY WELDING

PVC TARPAULIN 3 LAYERS

ROLL CLOSE



IPX5

QUICK FITTING

EASY TO FIT

EXTRALOAD

MOLLE SYSTEM

EXTRA STORAGE FLAP

SW42
SADDLE BAGS
X42 Y17 Z34 (cm)
Ref. X0SW42

100% WATERPROOF



SW 42 SADDLE BAGS **SW 38** DUFFLE REAR BAG **SW 45** REAR BAG **SW 23** TANK BAG



REF: X0SW42 SADDLE BAGS SW42 REF: X0SW38 REAR DUFFLE SW38 REF: X0SW45 REAR BAG SW45 REF: X0SW23B TANK BAG SW23B



Accessories (pag. 129)



SW23B

TANK BAG

X35 Y26 Z24 (cm)
Ref. X0SW23B

100% WATERPROOF



IB20

REAR BAG

∅ 25,5 Z53,5 (cm)
Ref. X0IB20



SW45

REAR BAG

X31 Y48 Z17 (cm)
Ref. X0SW45



ACCESSORIES FOR BAGS

MAGNETS (4U.)

Ref. X1SL11

FOR:

SL20F
SL12M
E04
SW23B



STRAPS

Ref. X1SL09

FOR:

SL20F



RAIN COVER

Ref. X1SL01

FOR:

E04
SL12M

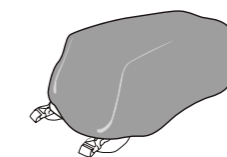

FILM PROTECTOR

Ref. X1SL02

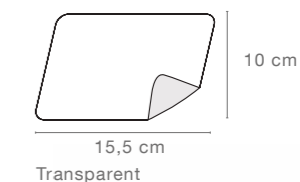

SW38

REAR DUFFLE BAG

X28 Y54 Z28 (cm)
Ref. X0SW38



UNIVERSAL BASE TANK

Ref. X1SL90

FOR:

E04
SL20F
SL12M



DUFFLE BAG IB08

Ref. X0IB08



LOCK MECHANISM + KEYS

Ref. X1SESTLR

FOR:

TR15
E03
E09



THERMO PAD

Ref. X1SB97

FOR:

E48
SL58
SW42



SMARTPHONE HOLDERS



MIRROR AND HANDLEBAR SYSTEM



SHAD ENGINEERED MOUNTING SYSTEM



360° SUPPORT

HANDLEBAR SIZES

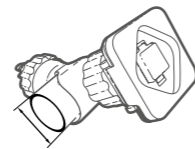

Ø 20-40 MM

SMARTPHONE CASE



- 1 LIGHT RAIN RESISTANT CASE
- 2 CABLE OUTLET
- 3 TOUCH SCREEN

X-FRAME SYSTEM

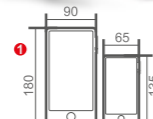

- 1 PHONE SIZES
- 2 SAFETY TETHER
- 3 RUBBER GRIPS
- 4 DESK SUPPORT

XFRAME / MIRROR AND HANDLEBAR SYSTEM

X-FRAME

HANDLEBAR HOLDER



180x90 mm

Ref. X0SG00H

MIRROR HOLDER



Ref. X0SG00M

SMARTPHONE HOLDERS WITH POCKET

HANDLEBAR HOLDER



MAX. PHONE SIZE

180x90 mm

Ref. X0SG76H

MIRROR HOLDER



Ref. X0SG76M

SMARTPHONE HOLDERS

HANDLEBAR HOLDER



MAX. PHONE SIZE

160x90 mm

Ref. X0SG62H

180x90 mm

Ref. X0SG71H

MIRROR HOLDER



Ref. X0SG62M

Ref. X0SG71M

RAIN JACKET



Size	cm	Ref.
S	57	X0SR55S
M	59.5	X0SR55M
L	62	X0SR55L
XL	64.5	X0SR55XL
XXL	67	X0SR55XXL
3XL	69.5	X0SR553XL

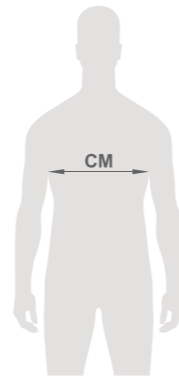

HAND MUFFS

X36.5 Y26 Z50 (cm)
Ref. X0SR00

Quick Fitting

Fur lining

Adaptable to a majority of motorcycles



RAIN PANTS



Size	cm	Ref.
S	34	X0SR20S
M	36.5	X0SR20M
L	39	X0SR20L
XL	41.5	X0SR20XL
XXL	44	X0SR20XXL
3XL	46.5	X0SR203XL

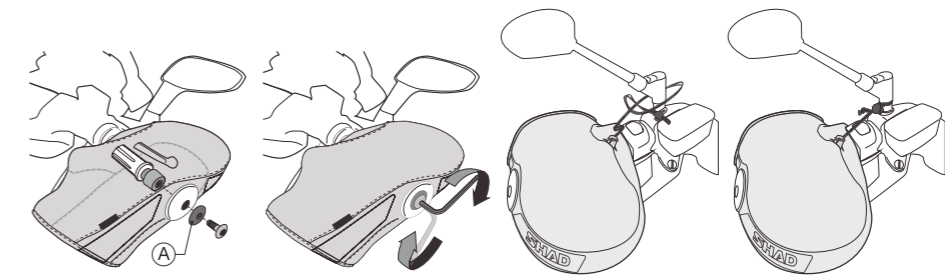
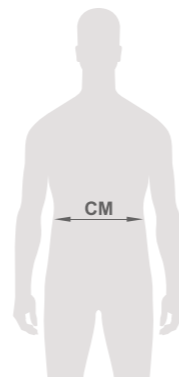

ATV CASES



ATV CASES / ATV80

ATV110

X58.5 Y93 Z34 (cm)
Ref. D0Q1100



ATV80

X55 Y90 Z26 (cm)
Ref. S0Q800



ATV40

X37 Y74 Z19 (cm)
Ref. D0Q200



SHAD LOCKS

SHAD LOCKS / SCOOTER HANDLEBAR LOCKS



FEATURES



SERIE 3

- 1 Premium lock cylinder up to 30.000 cycles
- 2 Reversible premium key with more than 10.000 keys combinations
- 3 The head set can rotate 360°
- 4 All components satisfy the REACH environmental Regulation
- 5 Side use of the cylinder lock: more comfortable and great water resistance
- 6 Cylinder lock fitting is inaccessible
- 7 Invisible assembly between the head set and the chain
- 8 Logo and other graphics are pad printed



SC 307H
Ref. C0S307H



49 cm

SC 305H
Ref. C0S305H



44 cm

SC 303H
Ref. C0S303H



38 cm

SERIE 2

- 1 Premium lock cylinder up to 30.000 cycles
- 2 Reversible premium key with more than 10.000 keys combinations
- 3 The head set can rotate 360°
- 4 All components satisfy the REACH environmental Regulation



SC 207H
Ref. C0S207H



49 cm

SC 205H
Ref. C0S205H



44 cm

SC 203H
Ref. C0S203H



38 cm



FULLY EQUIPPED MOTORCYCLES

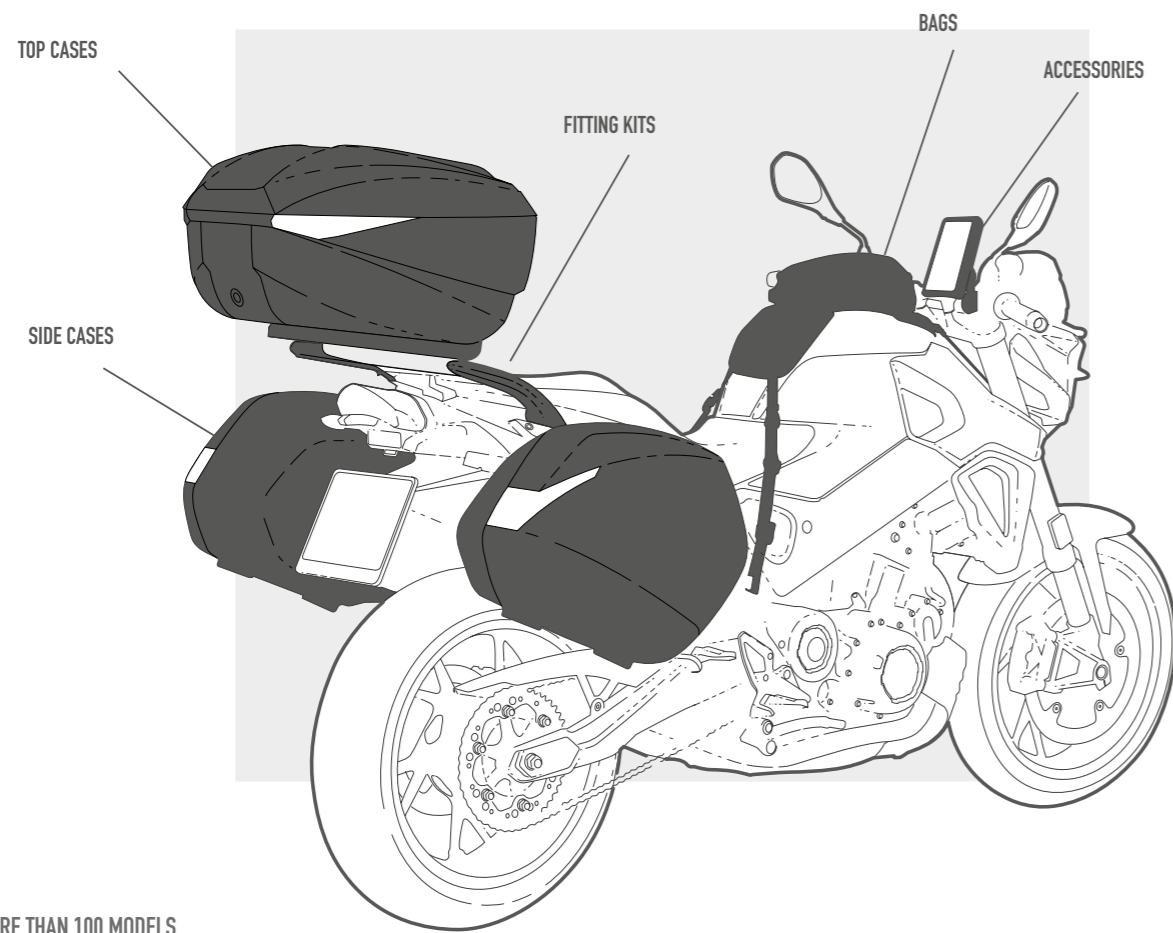

MORE THAN 100 MODELS



CHECK OUR FULLY EQUIPPED CATALOGUES:



TOP CASES



SIDE CASES



BAGS



FITTING KITS



SPARE PARTS

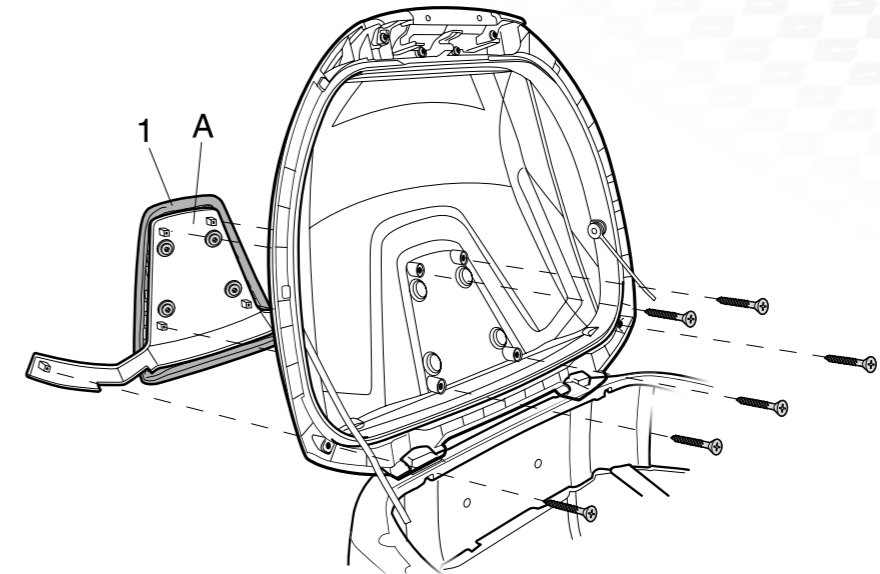

YOUTUBE SUPPORT CHANNEL:
TECHNICAL INFO
SPARE PARTS INSTALLATION
ACCESSORIES MOUNTING GUIDE

SHAD SUPPORT

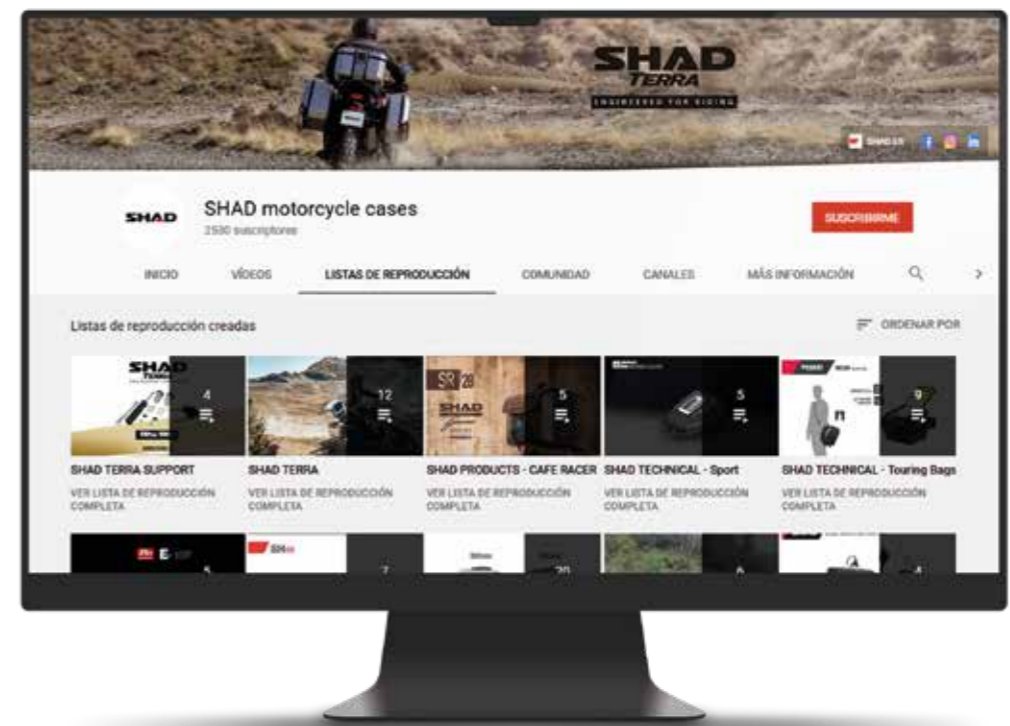

DISPLAYS

9 TOP CASES

Ref. D0EX03 (1U.) + D0EX02 (1U.) + D0EX10 (1U.) + D0EX14 (1U.)



4P SYSTEM DISPLAY

TERRA/TR40/SH38X/SH36/SH35 DISPLAY



SINGLE TOP CASE DISPLAY

SLATWALL: Ref. D0EXTRR



WALL: Ref. D0EXTRP



3P SYSTEM DISPLAY

TR40/SH38X/SH36/SH35/SH23 DISPLAY

D0EX58



D0EX201

RIGHT SIDE WALL DISPLAY

4P SYSTEM: Ref. D0EXP04P



3P SYSTEM: Ref. D0EXPIF



SADDLE BAGS DISPLAY

SR38/SL58/E48/E48SR

WALL: Ref. D0EX19SR



3 TOP CASES

Ref. D0EX02



BIG TOP CASES

SH59X-SH58X-SH50-SH48

Ref. D0EX10



FOR ALL TOP CASES. WITH FLOOR STAND

Ref. D0EX23 + D0EX02 or D0EX10 or D0EX14



CLICK SYSTEM DISPLAY

Ref. D0EX14



DESK DISPLAY:
Ref. D0EX01CS



ICON DESCRIPTIONS

SHAD

TR55
ALUMINIUM TOP CASE

TR50
ADVENTURE REAR BAG

TR40
ADVENTURE SADDLE BAGS

TERRA
48/37/47/36
ALUMINIUM CASES

SH59X
SH58X
EXPANDABLE CASES

SH36
SIDE CASES



ENGINEERED FOR RIDING

- Expandable case
- 2 flip-up helmets
- 2 full face helmets
- 2 helmets: full face and jet
- 2 Trail helmets
- 2 helmets: flip-up and jet
- 1 flip-up helmet
- 1 full face helmet
- 1 jet helmet
- Maximum load
- Secure lock system
- SHAD change colour system
- Compression straps
- Backrest
- Inner bag
- Upper rack
- Light
- Inner tray
- Capacity
- Reflector
- Waterproof
- Side Bag Holder
- Aluminium Mounting Plate
- Semi rigid
- Waterproof IPX5
- Handlebar bracket
- Mirror Bracket
- Safety lock
- SR Side Bag Holder
- Clean
- Quick assembly
- Practical
- Secure
- BCN
Designed & Made in BCN



NAD

SHAD NETWORK:

SHAD WORLD (BARCELONA)

Octave Lecante 2-6
Pol. Ind. Can Magarola
08100 Mollet del Vallès · Barcelona · Spain
Tel. +34 935 795 866
NAD Clients Tel. +34 935 795 860
Fax: +34 935 796 945

SHAD ESPAÑA

Tel. +34 935 795 870

SHAD FRANCE

Tel. +34 935 795 868

SHAD ITALY

Tel. +34 935 795 867

SHAD USA

19098 NE 4th Court
Miami FL, 33179
USA

SHAD CHINA

T: (+86)21- 62365730
Room 232, Building B,
No.668 Hengfeng Road,
Jing'An District, 200070
Shanghai - China

SHAD INDONESIA

Jl. Kemang Selatan VIII No. 56 Unit B
Jakarta 12730 Indonesia
Tel. +62 2122718560

info@shad.es

WWW.SHAD.ES

Code. 999322 Ed. 1



ISO 9001
ISO 14001
BUREAU VERITAS
Certification

