

Operating Manual

ERS Sound



Important safety information



Read this manual before attempting to install the device!

Failure to observe recommendations included in this manual may be dangerous or cause a violation of the law. The manufacturer, Elektroniksystem i Umeå AB will not be held responsible for any loss or damage resulting from not following the instructions of this operating manual.

- The device must not be dismantled or modified in any way.
- The device is only intended for indoor use. Do not expose it to moisture.
- The device is not intended to be used as a reference sensor, and Elektroniksystem i Umeå AB will not be held liable for any damage which may result from inaccurate readings.
- The battery should be removed from the device if it is not to be used for an extended period. Otherwise, the battery might leak and damage the device. Never leave a discharged battery in the battery compartment.
- The device must never be subjected to shocks or impacts.
- To clean the device, wipe with a soft moistened cloth. Use another soft, dry cloth to wipe dry. Do not use any detergent or alcohol to clean the device.

Disposal note in accordance with ElektroG and WEEE Directive 2012/19/EU

The device, as well as all the individual parts, must not be disposed of with household waste or industrial waste. You are obliged to dispose of the device at the end of its service life in accordance with the requirements of ElektroG in order to protect the environment and to reduce waste through recycling. For additional information and how to carry out disposal, please contact the certified disposal service providers. The sensors contain a lithium battery, which must be disposed of separately.



Contents

| | |
|--------------------------------------------------------------|----|
| Description..... | 4 |
| Main features of ERS Sound..... | 5 |
| Installation..... | 6 |
| Sensor configuration..... | 8 |
| NFC Configuration..... | 8 |
| Over the air configuration..... | 9 |
| Application parameters..... | 9 |
| Sensor behavior..... | 9 |
| NFC Read / Write..... | 9 |
| Sensor startup..... | 10 |
| Sampling mode / Periodic measurement..... | 11 |
| Schedule Transmission..... | 11 |
| Motion detection range..... | 12 |
| PIR Lens detection pattern..... | 12 |
| Specifications..... | 13 |
| Sensor payload format..... | 13 |
| Regulations..... | 14 |
| Legal Notices..... | 14 |
| Federal Communication Commission Interference Statement..... | 14 |
| Non-modifications Statement..... | 14 |
| Caution..... | 15 |
| Industry Canada Statement..... | 15 |
| Declaration of conformity..... | 15 |

Description

This is an advanced indoor environment sensor for LoRaWAN® wireless network. ERS Sound have internal sensors for measuring indoor sound levels (peak and average), temperature, humidity, light intensity, and motion. ERS Sound is a battery-powered device and is designed to be wall-mounted. The motion sensor can be used for presence monitoring systems. ERS Sound is equipped with NFC (Near Field Communication) and can easily be configured from a smartphone.

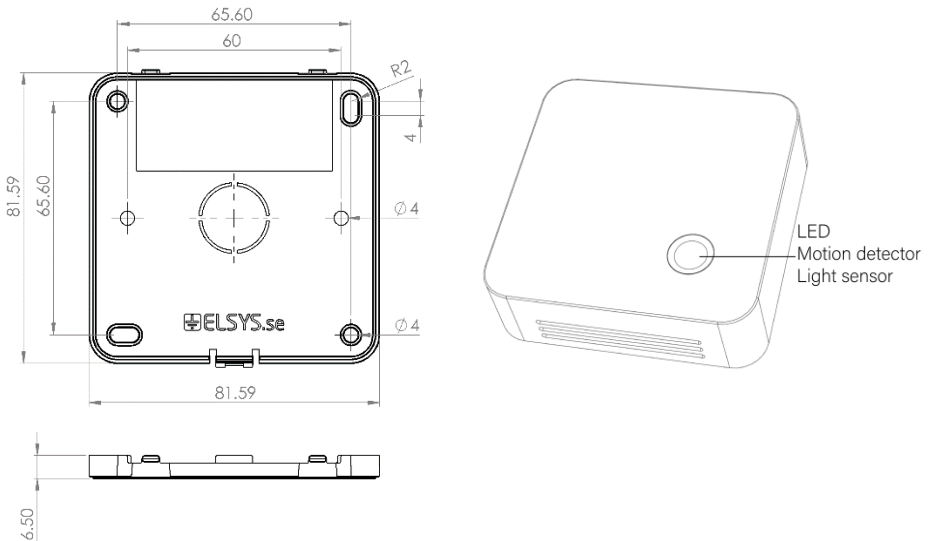

The barcode contains DevEUI and sensor type. This label is located at the back of your device,

Elsys.se ERS

DevEUI: A81758FFFFExxxxxx



elsys.se/lora

S-1933F



Main features of ERS Sound

- Compatible with LoRaWAN® specification 1.0.3
- Measures ambient sound levels (Peak and average)
- Never misses a sound event
- Measures ambient temperature
- Measures ambient humidity
- Measures light intensity
- Detects motion using a passive IR sensor
- Easy installation
- Easy configuration
- May be installed on a wall or any surface
- Battery-powered
- Long-range communication
- Configurable over NFC
- Configurable over the air
- Two years of battery life*
- Supported channel plans: US902-928, EU863-870, AS923, AU915-928, KR920-923, RU864, IN865 & HK923
- CE Approved and RoHS compliant

**Depending on settings and environmental factors*

Installation

1. Remove the back panel of the sensor with a small screwdriver.



2. Install the batteries. The ERS Sound requires one or two AA batteries. The battery type is 3.6V Lithium Battery (ER14505). You can use one battery, but it's recommended that you use two for best performance and battery life. Use battery slot A if only one battery is used.

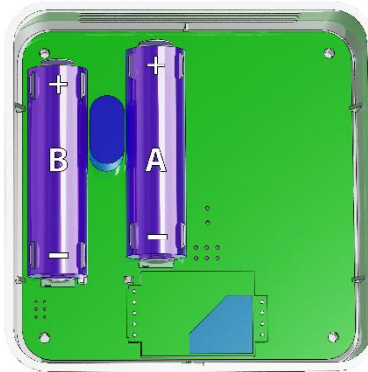

Caution: Using batteries other than the ones provided may result in loss of performance and battery life, and also damage to the device. Dispose of properly, observing environmental protection rules.

3. Mount the back panel on the wall using some of the six mounting holes. It may also be mounted using adhesive tape.

Caution: This device must not be placed near any doors, machines (e.g., printer, coffee machine) or in other areas where there's something that can make loud sounds. Such placements will give false sound values (both peak and average).

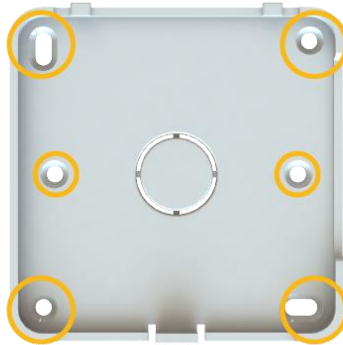

4. Attach the sensor part to the back panel.

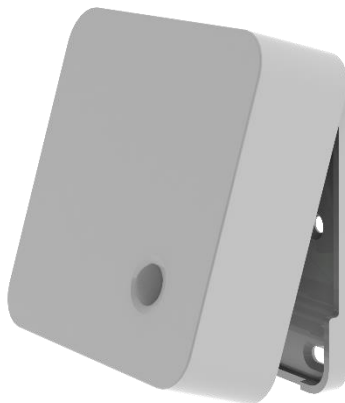

Sensor configuration

All sensor settings can be configured via a smartphone application with NFC (Near Field Communication) or over the air via the network server and downlink data to the sensor. The sampling rate, spreading factor, encryption keys, port, and modes can be changed. All sensor settings can be locked from the server or NFC to make end-users unable to read or change settings on the sensor.

NFC Configuration

1. Download ELSYS "Sensor Settings" application from Google Play and install it on a smartphone or tablet. The device must support NFC.
2. Enable NFC on the device and start the application.
3. Place your device on top of the NFC antenna on the sensor.



4. Remove the device. Current settings will be displayed in the application.
5. Use the application to change any settings if needed.
6. Quickly tap the device on top of the NFC antenna to give the new settings to the sensor. Make sure that the application confirms your new settings.
7. Wait for the sensor to reboot (5 sec), indicated by the LED flashing. Sensor settings have been updated.

See the section "Help" in the application for more information.

Over the air configuration

All settings may be configured over the air via your LoRaWAN® infrastructure. Please visit the support section on our webpage for more information regarding downlink protocol.

Application parameters

All parameters for the “Sensor settings” application can be found in our settings document. Please visit the support section on our webpage for more information.

Sensor behavior

NFC Read / Write

1. When reading or writing NFC configuration data to the sensor, it starts a timer and delays its action 5 seconds.
2. After the delay, the sensor determines if the NFC data has changed or not. If the data has changed, the sensor reboots and starts from power-up.
3. Write your settings in the application and then locate the NFC antenna of the phone and sensor. Keep the two devices close and don't move them to get the best connectivity as possible when writing or reading data to the sensor. Bad connection can be caused by long distance, wrong location, or rapid movement.
4. When you have written data to the sensor, let the sensor reboot and restart before trying to write again.

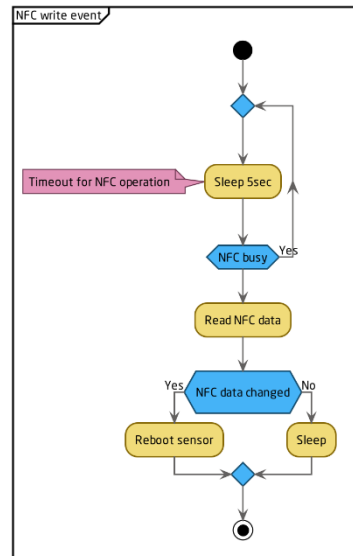

You should always validate your settings by reading the NFC data after the sensor has restarted.

Sensor startup

1. When the sensor starts up, it loads configuration from the internal memory and merges it with user configuration.
2. When the configuration is done, the sensor writes the new configuration to the NFC chip. The sensor always writes new configurations to the NFC chip when something changes in the sensor or if NFC data is corrupted by an NFC writer or phone. The sensor always writes the new configuration to NFC chip at startup.
3. When the configuration is done, the sensor tries to join the network if OTAA (Over the Air Activation) is enabled.
4. The sensor LED flashes orange when it tries to join a network. It will try to join every 10 seconds initially. This interval will increase to save battery, at most up to one time per hour.
5. After successful connection to a network, the sensor sends a settings packet and enters sampling mode.

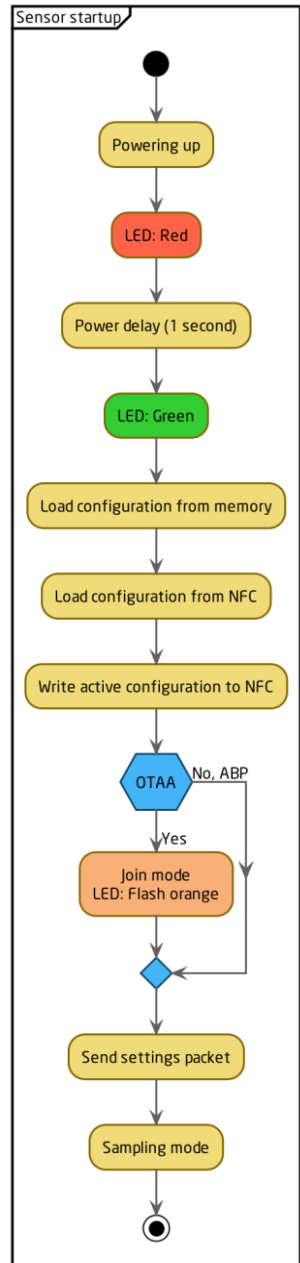

Sampling mode / Periodic measurement

The sensor makes periodic measurements according to the user configurations.

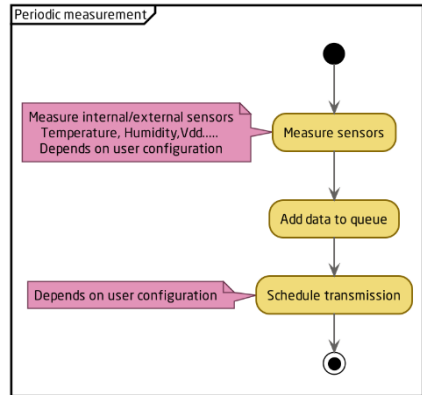

Schedule Transmission

The sensor transmits the data according to the user configurations.

Note: The configured sending interval can be overridden by network limitations. Due to this, the spreading factor and sending interval settings might result in longer intervals than intended.

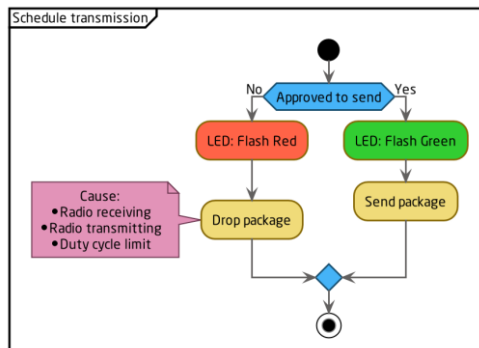

Motion detection range

Actual range of the sensor can be influenced by environmental conditions. Avoid installing the sensor in areas where it will face direct or reflected sunlight. Avoid installing near windows, air conditioning, or heating vents. Such placements will give false values.

The PIR can cause self-trigger if sensors are placed too close to each other. Keep this in mind when you mount or test the sensors.

Note: The PIR Lens has a blanking time of 20 seconds right after motion event and transmission. Any movements during this time will be ignored.

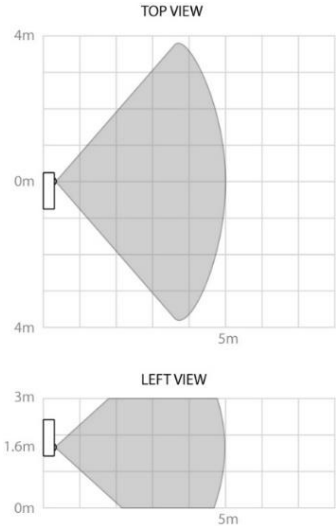

PIR Lens detection pattern

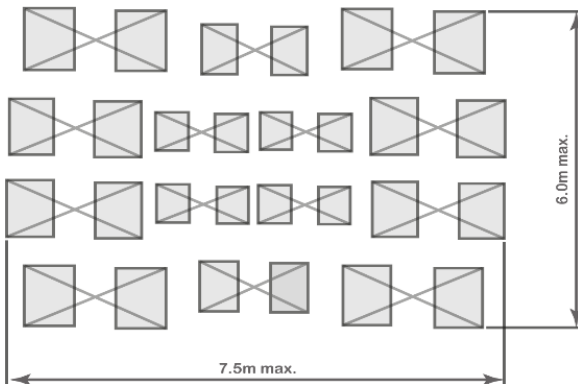

Specifications

Sensor payload format

The device uses the standard ELSYS payload format. Please see the specified document on our webpage.

| | |
|----------------------------------|-------------------------------------------------------------------------|
| Power supply: | 3.6V DC |
| Battery type: | AA 14505 (Li-SOCl ₂) |
| EU directives compliance: | RoHS 2011/65/EU WEEE 2012/19/EU |
| Radio protocol: | LoRaWAN® |
| Radio frequency band: | US902-928, EU863-870, AS923, AU915-928, KR920-923, RU864, IN865 & HK923 |
| Range: | 8 km* |
| Recommended installation height: | 1.6 m |
| Operating conditions | 0 to 40 °C 0 to 85 % RH (non-condensing) |
| Sound range, mean value | 35 – 70 dBspl |
| Sound range, peak value | 65 – 99 dBspl |
| Sound resolution | 1 dB |
| Temperature range | 0 – 40 °C |
| Temperature resolution | 0.1 °C |
| Temperature accuracy | ± 0.2 °C |
| Humidity range | 0 – 100 % |
| Humidity resolution | 0.1 % RH |
| Humidity accuracy | ± 2 % RH |
| Light range | 4 – 2000 Lux |
| Light resolution | 1 Lux |
| Light accuracy | ± 10 Lux |
| Dimensions | 86 x 86 x 28 mm |
| Battery life | Up to 2 years** |

*Measured with settings: SF10, 868 Mhz. The range can be greater or less, depending on terrain and building structure.

**Depending on settings and environmental factors.

Regulations

Legal Notices

All information, including, but not limited to, information regarding the features, functionality, and/or other product specification, are subject to change without notice. ELSYS reserves all rights to revise or update its products, software, or documentation without any obligation to notify any individual or entity. ELSYS and ELSYS logo are trademarks of Elektroniksystem i Umeå AB. All other brands and product names referred to herein are trademarks of their respective holders.

Federal Communication Commission Interference Statement

This equipment has been tested and found to comply with the limits for a Class B digital device, according to Part 15 of the FCC Rules. These limits are designed to provide reasonable protection against harmful interference in a residential installation. This equipment generates, uses and can radiate radio frequency energy and, if not installed and used in accordance with the instructions, may cause harmful interference to radio communications. However, there is no guarantee that interference will not occur in a particular installation. If this equipment does cause harmful interference to radio or television reception, which can be determined by turning the equipment off and on, the user is encouraged to try to correct the interference by one of the following measures:

- Reorient or relocate the receiving antenna.
- Increase the separation between the equipment and receiver.
- Connect the equipment into an outlet on a circuit different from that to which the receiver is connected.
- Consult the dealer or an experienced radio/TV technician for help.

Non-modifications Statement

Any changes or modifications not expressly approved by the party responsible for compliance could void the user's authority to operate this equipment.

Caution

This device complies with Part 15 of the FCC Rules. Operation is subject to the following two conditions:

(1) This device may not cause harmful interference, and (2) this device must accept any interference received, including interference that may cause undesired operation.

This device and its antenna(s) must not be co-located or operating in conjunction with any other antenna or transmitter except in accordance with FCC multi-transmitter product procedures.

Industry Canada Statement

This device complies with Industry Canada license-exempt RSS standard(s). Operation is subject to the following two conditions:

(1) this device may not cause interference, and

(2) this device must accept any interference, including interference that may cause undesired operation of the device.

Declaration of conformity

Hereby, Elektroniksystem i Umeå AB declares that ERS Sound complies with the essential requirements and other relevant provisions of Directive 2014/30/EU and 2014/53/EU.