

Make it your

# Work space



## Collaboration

- 4 Co-working benches
- 8 Shared workstations
- 12 Meeting

## Social

- 16 Welcome
- 20 Getting together
- 24 Lounge
- 28 Cafeteria
- 32 Relax

## Focus

- 36 Creative zone
- 40 Creative space
- 44 Multiple workstations
- 48 Individual workstations
- 56 Executive offices
- 60 Ergonomic offices

## The USM world

- 64 Strong core values
- 66 Product information
- 78 Colors & surfaces

New ways of living and collaborating have especially affected the way workplaces are designed and furnished today – and the workplace will be subject to further change in the near future.

The traditional individual workstation has become one of many. The contemporary office world is open: modifiable arrangements are more and more essential for meeting today's requirements of constant communication, well-being and flexibility in thinking, acting and collaborating.

These times perfectly suit USM. Modularity, versatility and quality have always been associated with USM: our wide range of modular elements, of adaptable office furniture, helps you design a workspace that conforms exactly to your coworkers' individual needs and the overall demands of your company today and in the future – creating a setting where you, your employees and teams feel comfortable and empowered to tap their full creative potential.

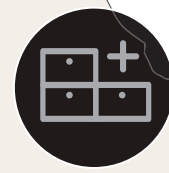
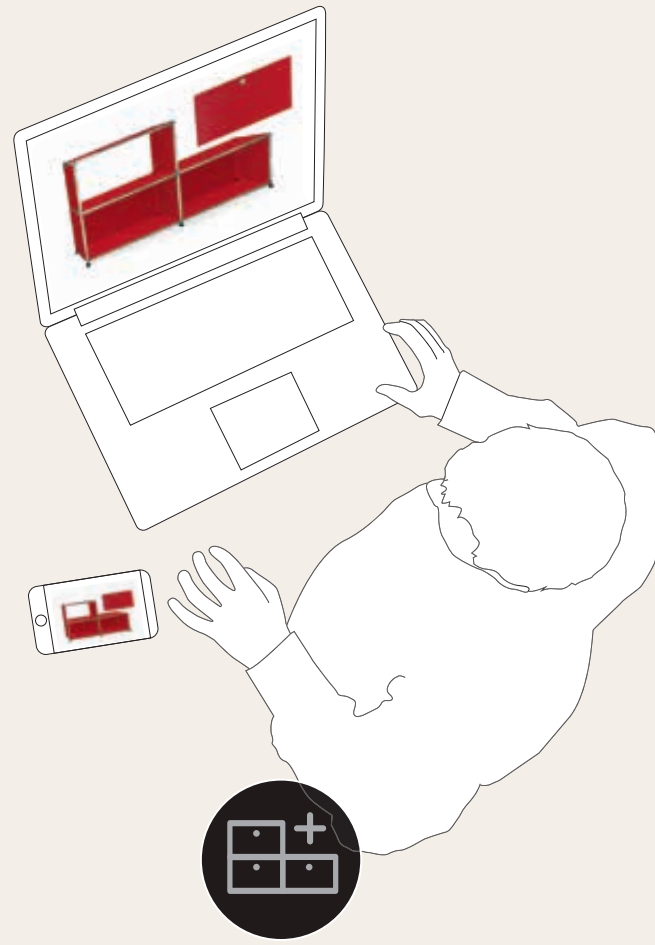

**Online Configurator**  
Design your individual piece of USM online!



**Customized Service**  
Visit a USM Showroom or one of our 400 international sales partners worldwide for individual support. Find your closest USM professional online.

[www.usm.com](http://www.usm.com)



TUESDAY

PROS

→ OUR FUTURE  
TRENDS

MARKET

→ THE FUTURE  
OF BUSINESS

MINER

LIFE OF OUR DATA SHOULD BE TALK

GOAL

GROUP STANCE  
PROBLEM

Trust

Summary

Central

Diversity

... (many other sticky notes)

# A glimpse into the future of work



Ben van Berkel – Founder of UNStudio



Ren Yee – Head of Innovation  
Strategy & Forecasting

Over the past year USM has collaborated with the UNStudio Futures team to explore the spatial implications of work in the future. Today we can't even imagine the jobs that will exist in 2030.

**Organ designer, Cybernetic director, Drone experience officer. How will our work change, and what kind of spaces will we need?**

We began tackling these questions at our booth at Salone del Mobile 2018 – Home-Work. The design illustrated the merging of home and work environments which results from digital devices, platformisation and the emergence of a planetary labour market. We won two Frame awards, energizing us to dig deeper into the topic through scenario-building PlayLabs, where participants unpacked the hopes and fears which pervade conversations about the future.



So how has work changed over the past 50 years? Our beloved devices were meant to lessen our workload and increase our leisure time by allowing us to work anywhere, anytime. In reality we've ended up working everywhere, all the time. Fundamentally, our interaction with computers hasn't changed since they were invented – we stare at a screen and watch information move around on it.

**What if we were no longer tethered to a desk? We forecast a more playful future for work.** Business is moving from a long period where analytical skills were valued highest in the search for efficiency, to one where creative skills become essential to deal with complexity, volatility, and the requirements for constant innovation. In the future we will all need to be designers.

How should workspace respond?

**The next revolution in office design will release us from our desks and allow us to use our whole bodies at work.**

Personal voice assistants will guide our work and screens will be replaced by conversation, gesture and light. Extended Reality (XR) spaces will allow us to literally pull information around in physical space, from one side of a room to another.

At the same time, our persistent desire for collectivity calls for discrete environments which signal what type of interaction they are open for – from focus to one-to-one to collaboration – as well as what level of technology they contain. Some will be tech-free zones where texture and tactility win out, allowing us to display our personality and build collective identity. Eventually, tech and tactility will integrate. We'll immerse ourselves in nature, growing food with indoor hydroponic systems or taking our work out into nature using Augmented Reality to build on real-world experiences.

Ben van Berkel,  
Ren Yee



Collaboration

# Co-working benches







# Collaboration

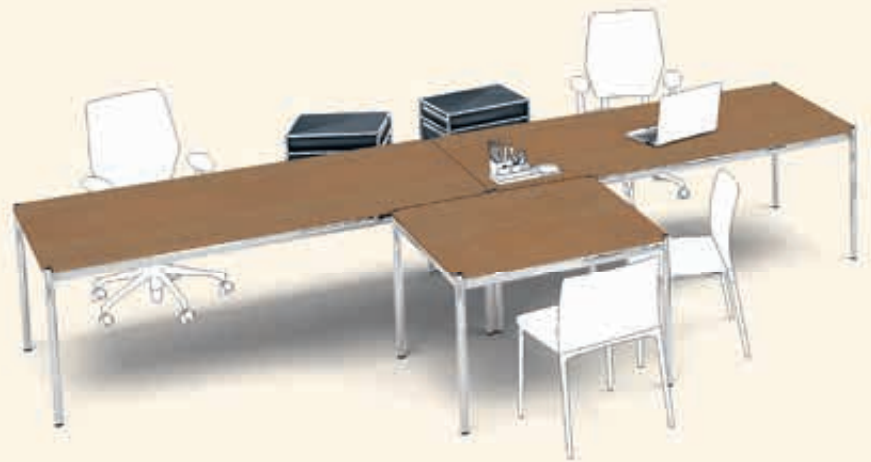

Plug and play  
Via small cable ports  
in each table, your  
laptops, smartphones  
and other tools easily  
connect to electrical  
and communication  
networks. Just plug in  
and keep working.



## Team spirit

- 1.0 Get together at one large desk: USM Haller Plus three-meter-long desks in golden yellow powder-coated MDF create a colorful and inspiring shared workstation in the modern co-working space – including adaptation points for various smart accessories such as lamps, USBs, and flat screen support bars.



## Superdesk

- 2.0 Work methods vary, teams change size and composition. Your office layout adapts to your evolving needs and projects. USM Haller desks come in brown oiled-oak veneer and in various other colors, sizes, shapes and materials. Adding our pedestals maximizes space and agility.



## Dividing space, connecting people

- 3.0 USM Haller combines various functions in one piece of furniture. Providing storage space and dividing rooms, it also works perfectly as a standing counter for ad-hoc team meetings – inspiration and variation unlimited. And it's all in gentian blue, bringing a welcome dash of color to your workspace.

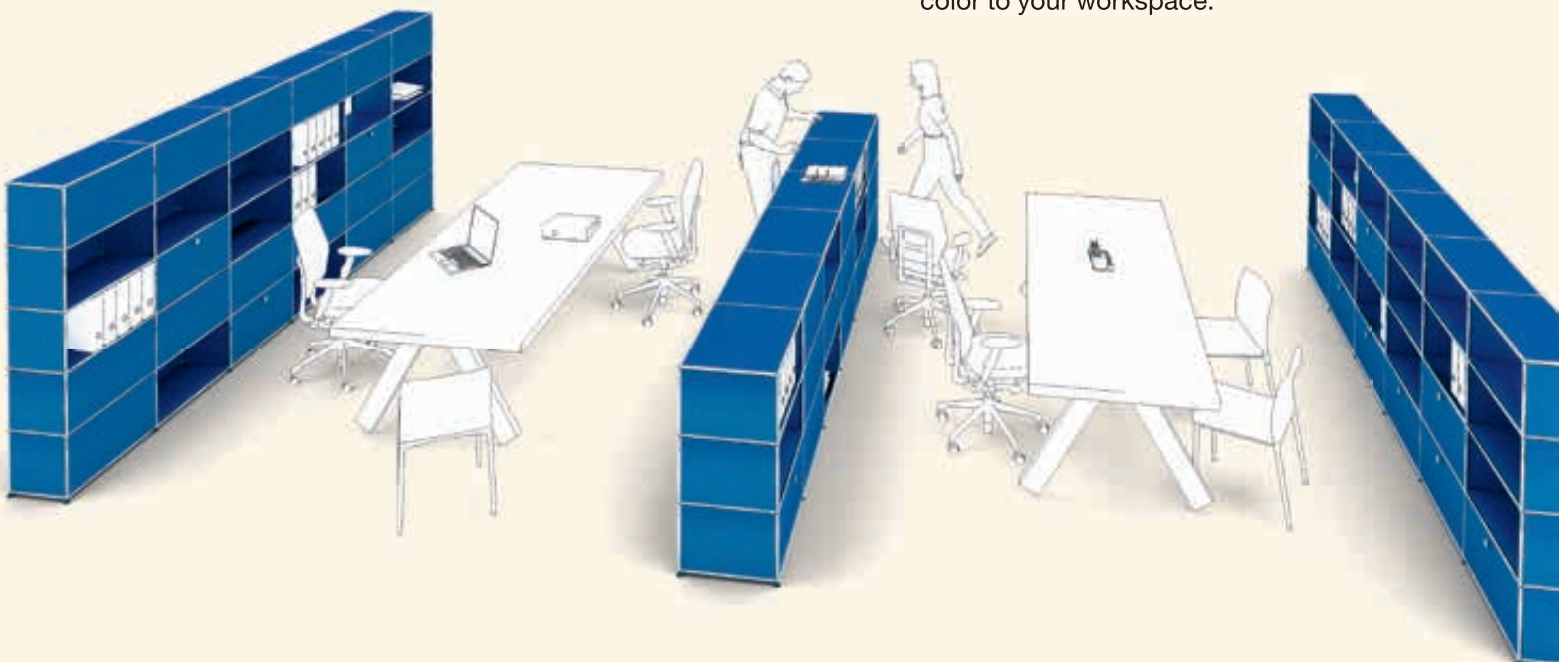

Collaboration

# Shared workstations





# Collaboration



## Agility, collaboration

4.0 Five height-adjustable USM Kitos M Plus desks in light mid-gray laminate build one agile workstation – enabling a quick change from one desk to another, sharing work on a common project.

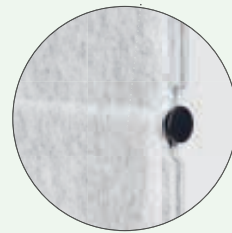

Sound absorption and privacy  
Ensure privacy and optimize acoustics in the shared workstation: USM Privacy Panels offer a modular solution that can be quickly positioned and removed according to situational needs.



The new adjustable flat screen support bar; move forward or backward – two notches at a time to adjust the viewing distance.

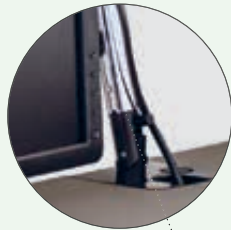

## Hot desking

5.0 Modern shared workspace: six height-adjustable Kitos M Plus desks in warm dark gray laminate make six workstations. Several workers use one workstation on a rotating schedule – each with their own pure orange caddy holding their personal work material.

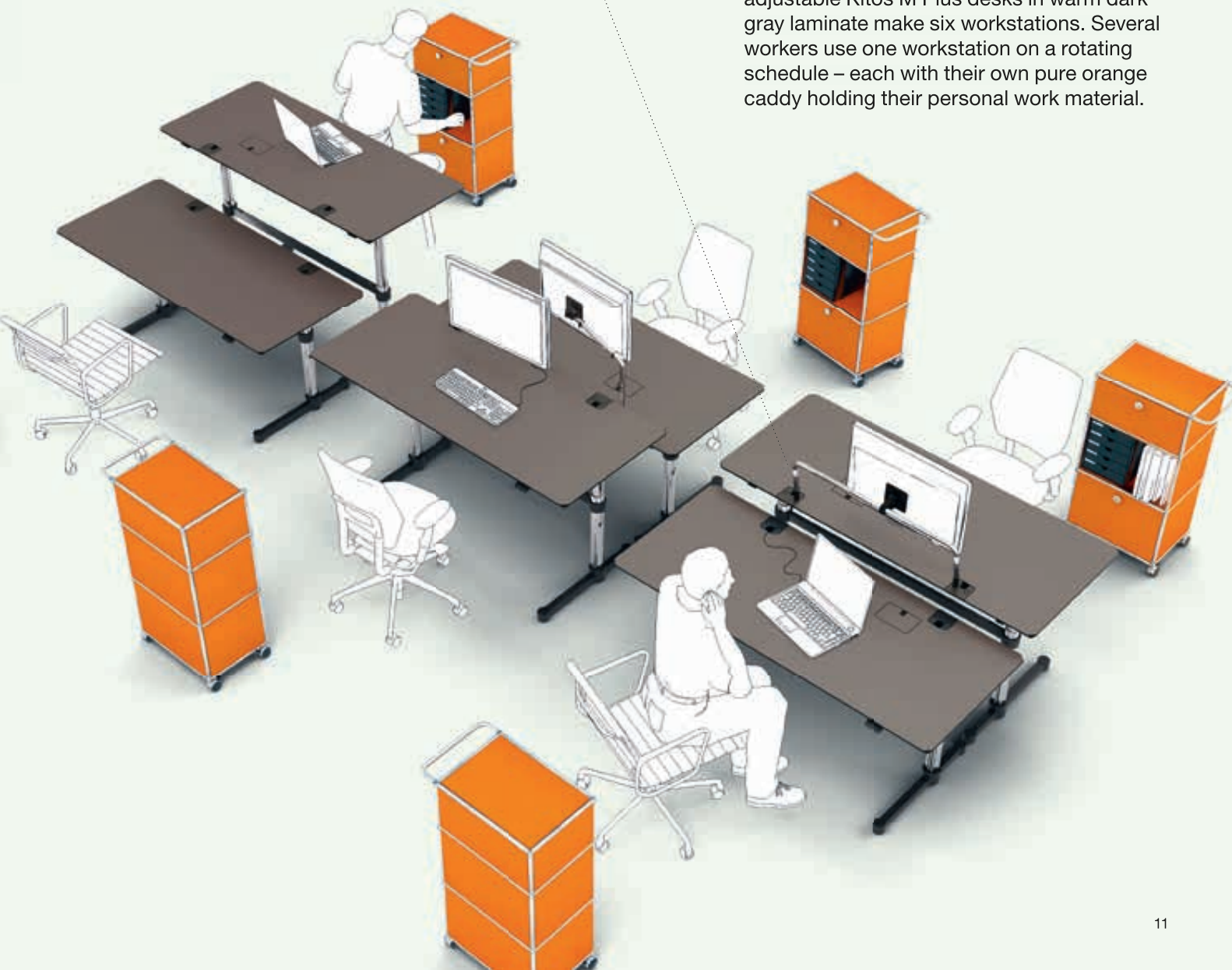

Collaboration

# Meeting







# Collaboration



## Classic conference

6.0 Meeting at the highest level of style: the three-meter-long USM Haller table in white oiled-oak veneer creates an impressive figure in a simple environment – elegant, timeless, representative.

Sound absorption  
Perforated metal panels with a fleece-covered interior: acoustic USM Haller elements significantly reduce background noise, thus improving the overall work environment.

## Sophisticated storage

7.0 A vast amount of storage space: the classic USM Haller sideboard in matte silver is extremely useful and adds a sophisticated air to any meeting environment.

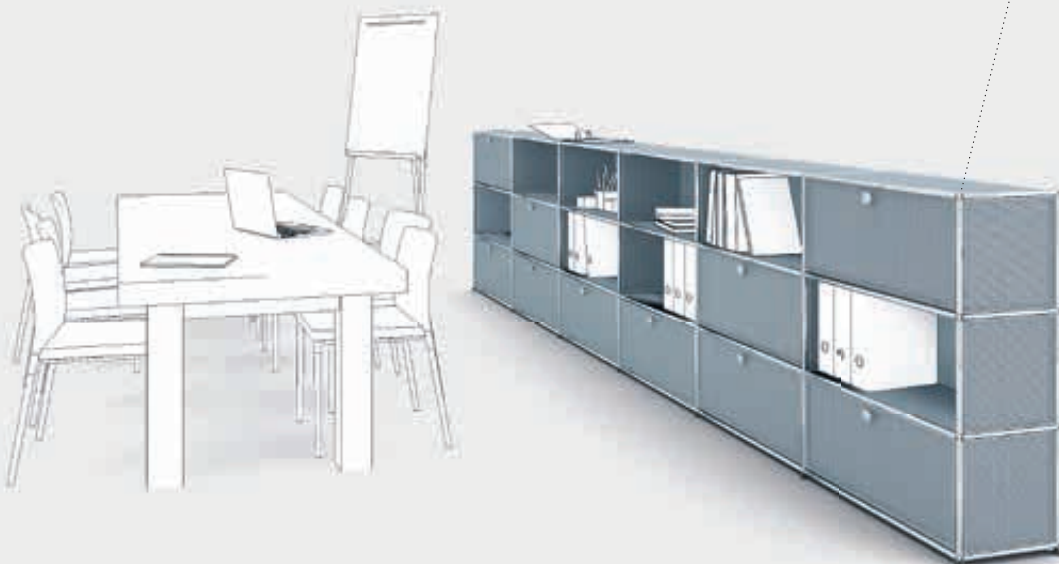

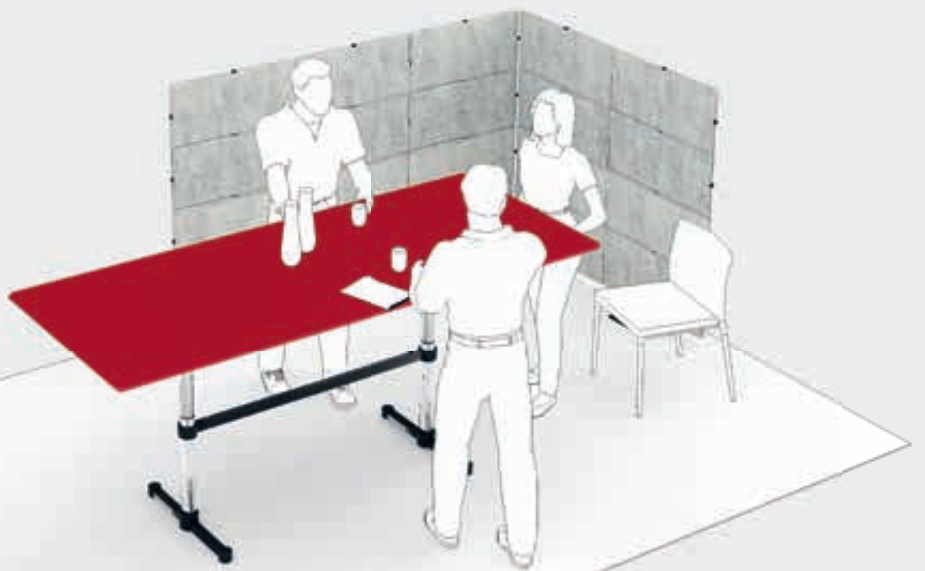

## Dynamic meeting

- 8.0 A lot of space at a comfortable height: the USM Kitos M Meeting desk is made for ad-hoc stand-up meetings of up to eight people – Intuitively height adjusted in a moment.

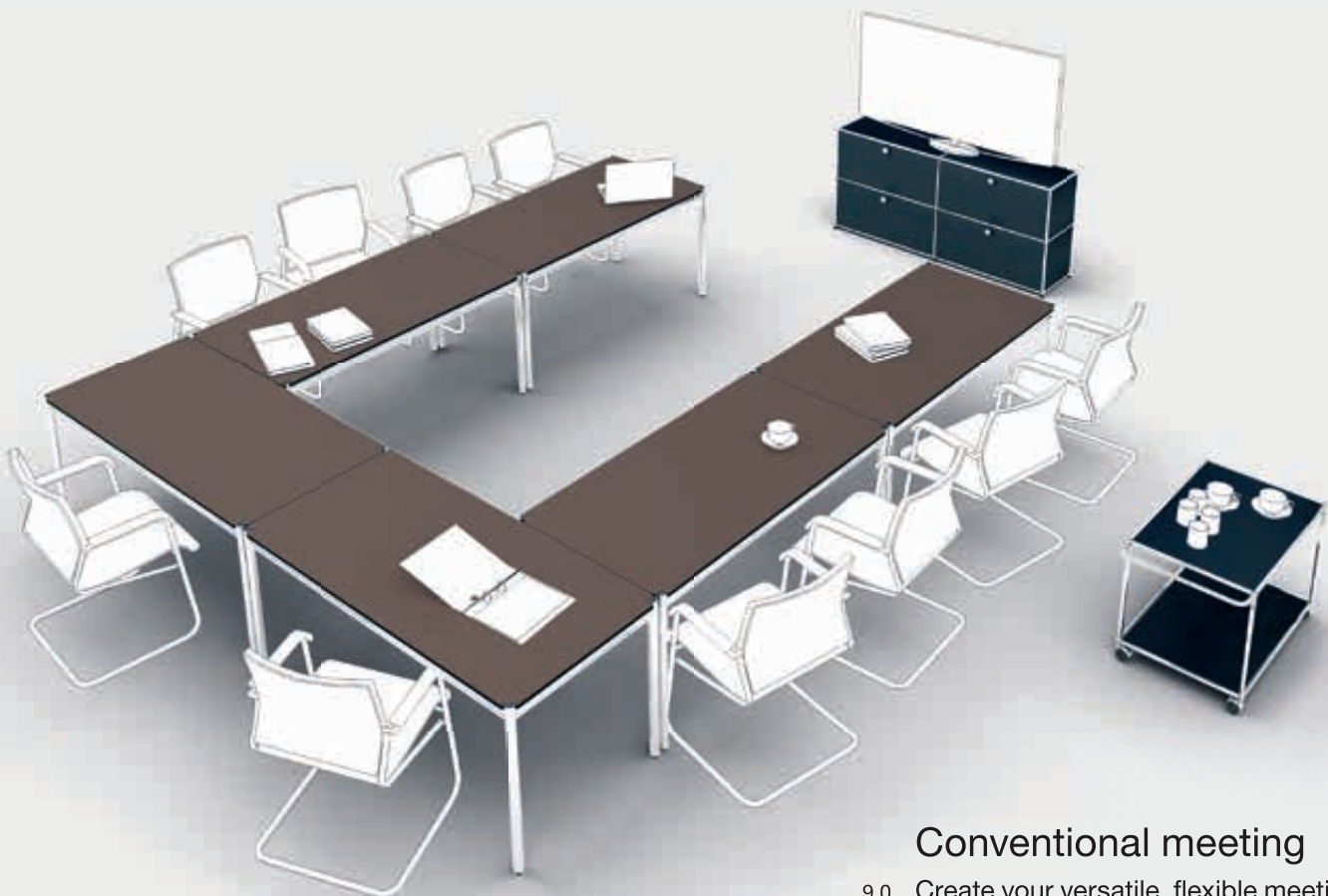

## Conventional meeting

- 9.0 Create your versatile, flexible meeting room: all elements are quickly rearranged according to particular needs and conditions. Six USM Haller rectangular tables in mauve linoleum, a USM Haller serving cart and sideboard, both in graphite black, make the ideal layout for successful presentations, offering a clear view for everyone and enough space for technical equipment.

Social

# Welcome





# Social

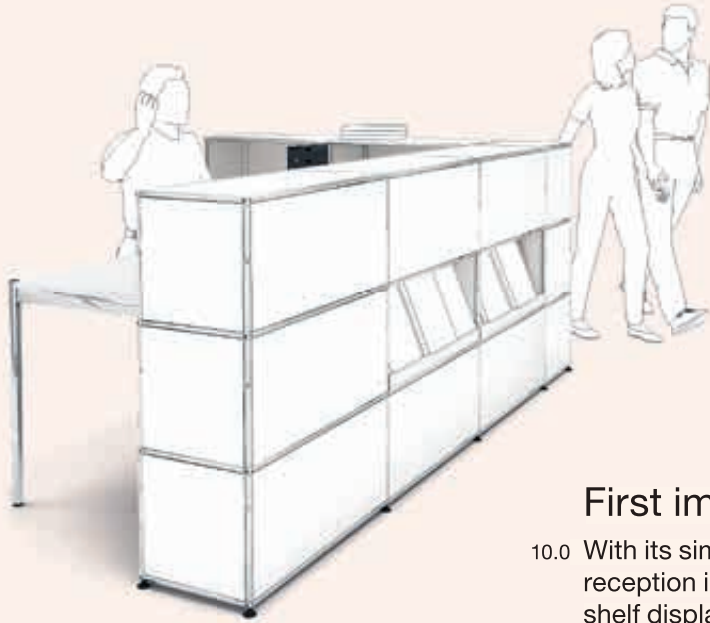

## First impressions count

10.0 With its simple yet elegant face, the USM Haller reception in pure white, with a metal angled shelf displaying brochures and magazines, is a friendly and respectable greeting to visitors and business partners. Plus, it offers plenty of well-hidden storage space. The pure white powder-coated MDF USM Haller desk is a perfect, practical solution.

## A warm welcome

11.0 The freestanding USM Haller highboard in pure orange marks a friendly spot in any office environment. At peak multifunctionality, it can be used as a greeting area, an information point or a docking station – placed and moved to wherever it fits.



## Take a seat

- 12.0 The USM Haller reception unit is a visual cue to welcome visitors and to indicate where they should be in the building. It can be provided with guest seating, which is convenient if the reception area is also used for discussions or structured meetings.



Colorful islands  
USM Privacy Panels  
are available in a wide  
range of different  
colors. Adapt them  
to your needs and  
taste, easily remove  
and reassemble them  
as you like.

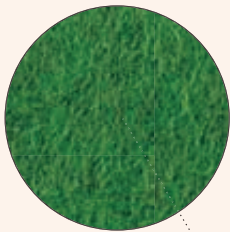

## Waiting in style

- 13.0 With USM Privacy Panels, one quickly creates a private space within an open-plan reception. Add a comfortable sofa and a pure orange USM side table to set up an ideal waiting area, comfort zone or place of retreat.

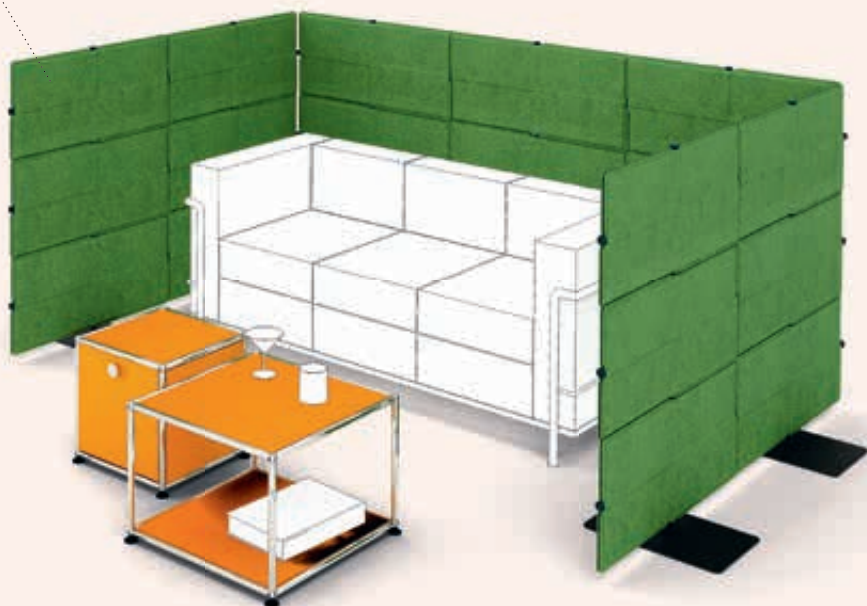

Social

# Getting together







# Social

Added storage value  
Metal extension doors:  
easy to open, conceal-  
ing private storage.

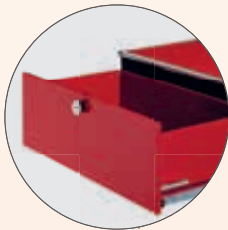

## Office forum

14.0 The ruby red USM Haller bench provides a lot of storage. But it offers much more. With it, you can create your own office forum, a spot where you can take a break or conduct an informal meeting, with built-in storage for whatever the team needs at the ready.

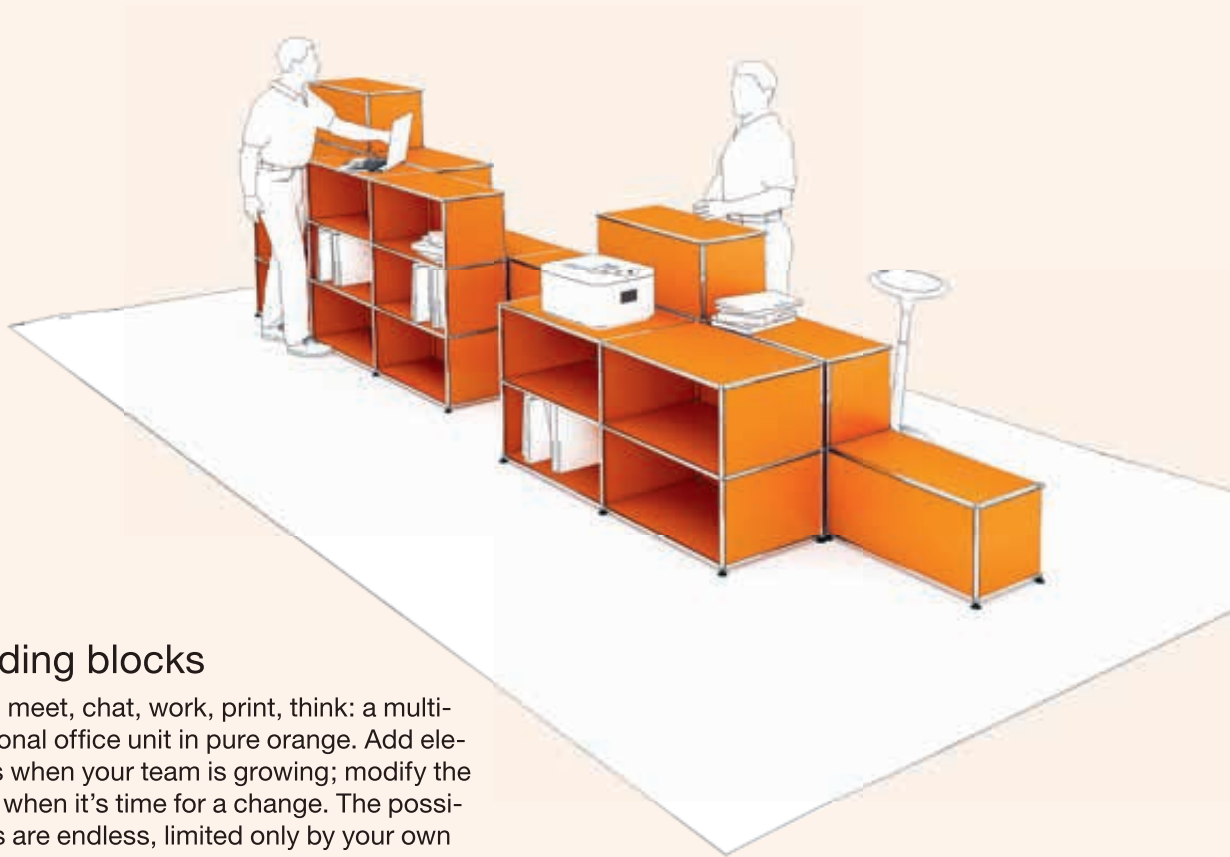

## Building blocks

- 15.0 Store, meet, chat, work, print, think: a multi-functional office unit in pure orange. Add elements when your team is growing; modify the setup when it's time for a change. The possibilities are endless, limited only by your own imagination.



## Get together

- 16.0 It's all about the perfect composition: the pure white multifunctional USM Haller units and the multicolored USM Privacy Panels – combine functions, colors, sizes and shapes into whatever communal area you want and need.

Social

# Lounge





# Social

Added storage value  
Magnetic metal book-ends make a perfect match for a USM Haller bookshelf. Discover the full range of smart accessories on page 67.



## A space to share

- 17.0 Create your own stylish island: take a beige USM Haller bookshelf with angled shelves as a magazine display and add a number of USM Haller side tables (for instance; beige, brown and pure white) in a playful yet elegant combination. Your perfect place to relax with colleagues.



Bookends  
Another elegant solution for your bookcase. Discover the full range of smart accessories on page 67.

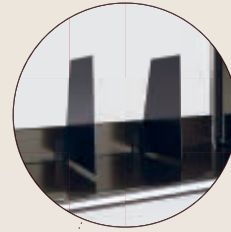

## Open library

18.0 This is much more than an ordinary bookshelf: the brown USM Haller bookshelf is accessible from either side, it works as a semi-transparent room divider while providing space for a lot of books, of course. Additional functionality is provided by the brown side storage and the height-adjustable USM Kitos E freestanding round table in natural oiled-oak veneer.

## Private areas

19.0 Bring coziness to your office to make you and your colleagues feel at home: USM Privacy Panels provide seclusion, USM Haller coffee tables in colorfully back-lacquered clear glass add a living-room touch and the pure white storage is an elegant extra.



Social

# Cafeteria







# Social

## Snack bar

20.0 The green USM Haller unit is accessible from both sides. It is storage space and counter at once – and as such, the perfect office kitchen solution. More drawers, doors, dividing shelves and smart accessories can be added at any time.



## Coffee time

21.0 A friendly place where colleagues gather for a quick lunch or coffee break: the light gray USM Haller counter with glass showcase – for small dishes, cakes or desserts – makes a great coffee bar in any work environment. Take a break!

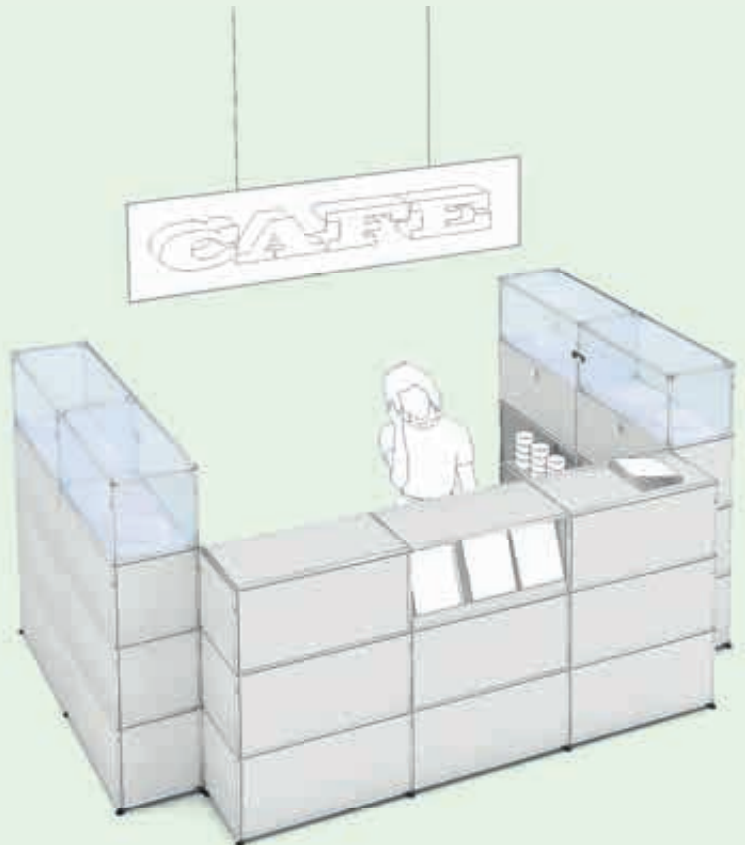

Height adjustment  
Energy-saving, continuously height-adjustable, both in standing and in sitting positions.



## Lunch break

22.0 Enjoy your meal at the office in a colorful, relaxing atmosphere – while sitting or standing. The freestanding height-adjustable square and round USM KITOS E tables are made of powder-coated MDF – and available in many different colors.

Social

# Relax





# Social

## Multitasking

23.0 A multimedia library for the modern-day office becomes a social area to meet for a break or an informal meeting. And nothing is wanting: storage room, books and magazines, entertainment and communication devices are all on a USM Haller light gray and graphite black shelf with a wide variety of drawers, as well as drop-down and flip-up doors.



## Classy comfort

24.0 Take a break in style: with its elegant design, the beige USM Haller sideboard with glass displays combines perfectly with sophisticated furniture and accessories. Enjoy your time with timeless design!

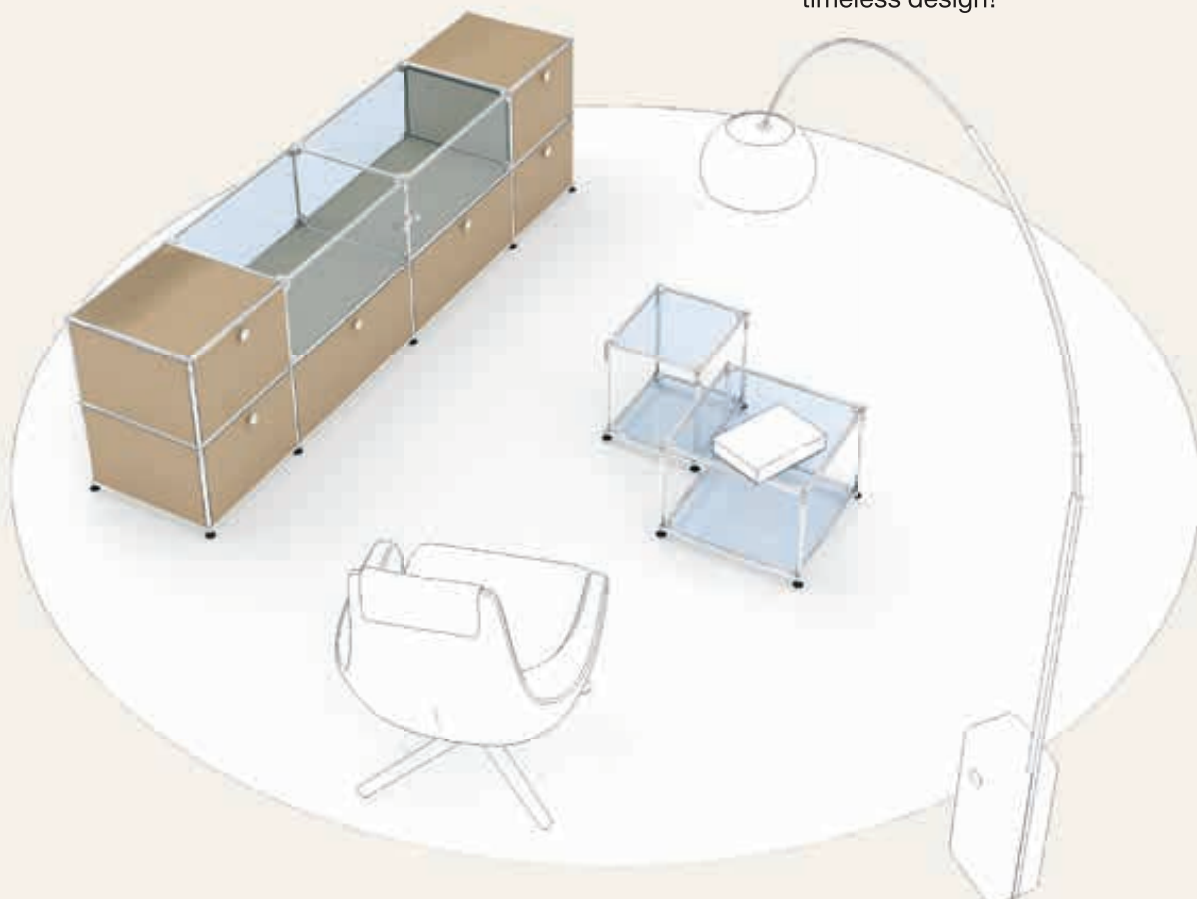

Versatility  
Spherical connectors,  
tubes and panels –  
it's child's play to com-  
bine these elements  
to build the furniture  
of your choice. You can  
do it online too, with the  
aid of the Configurator!  
[www.usm.com](http://www.usm.com).

## Game arena

25.0 Feel free to lay back and relax for a while – even at work. The modern workplace offers room to unwind, socialize and play games. And it doesn't take much to create it. Arrange some small green USM Haller storage units and side tables in a free-spirited way.

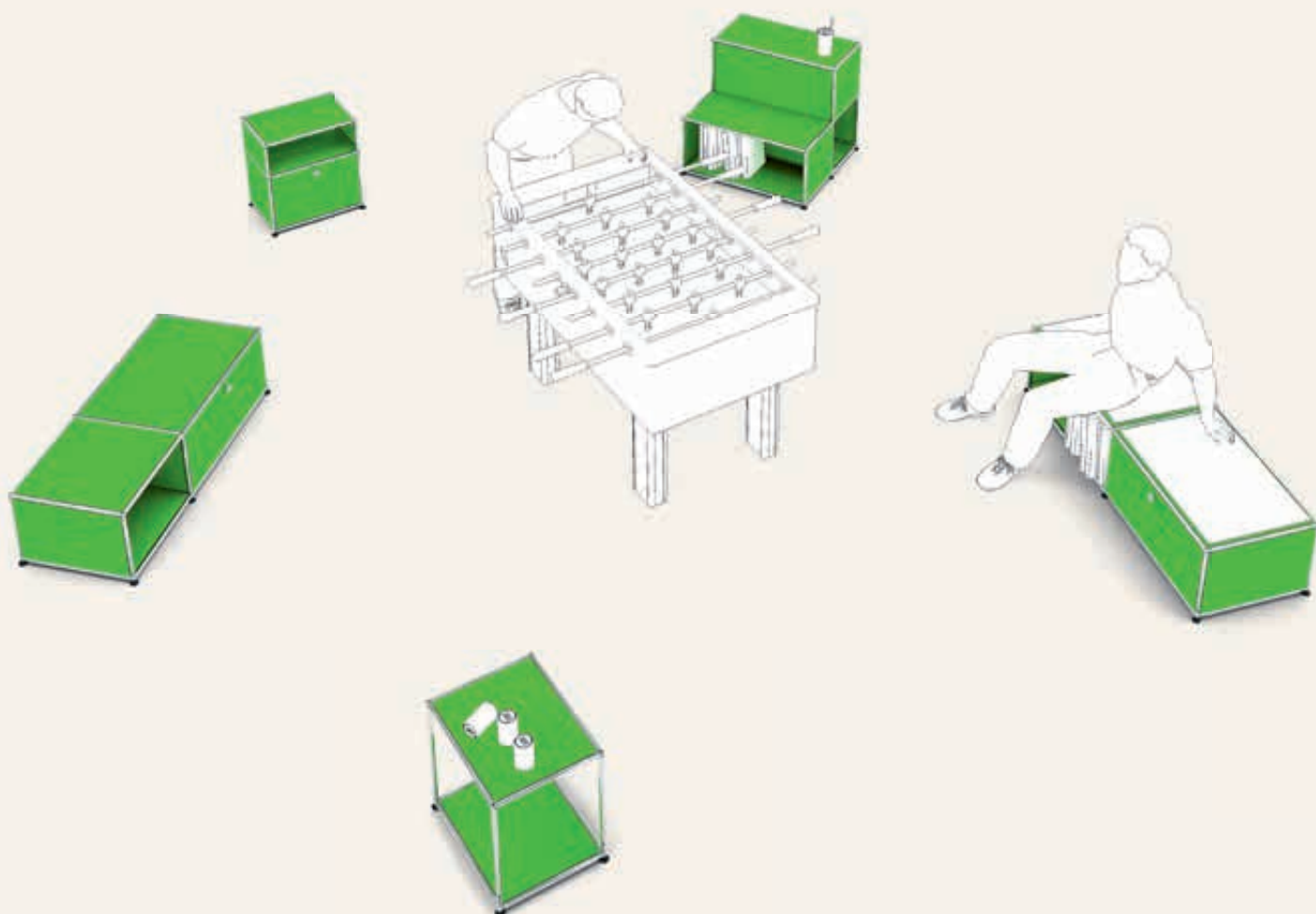
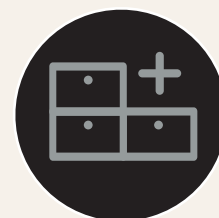

Focus

# Creative zone







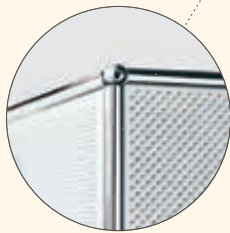
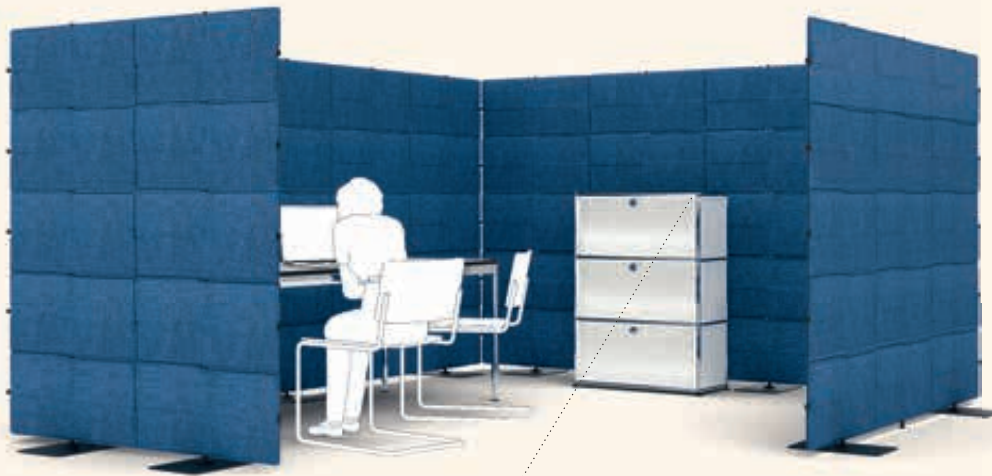

Sound absorption  
Perforated metal panels with a fleece-covered interior: acoustic USM Haller elements significantly reduce background noise, improving the overall work environment.

## Thinking space

26.0 A place to retreat in the open-plan office: blue USM Privacy Panels protect you from the outside world and absorb background noise. The pure white USM Haller storage unit is also equipped with acoustic elements – creating the ideal conditions for focused work and creative meetings.

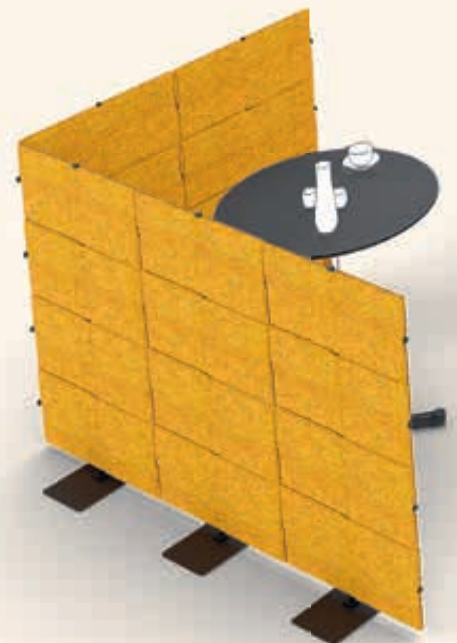

Free structures  
The single USM Privacy Panels are also linked to one another by a specific detail in their geometry allowing them to behave as one single surface.

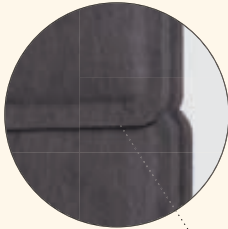

## Creative village

27.0 The ways of creating, combining and using focus workstations are countless. USM Privacy Panels offer a modular and flexible way to create breakout areas within a room to enable different work modes in a small space. Add a touch of color where appropriate.



Each area can be customized by size, height, shape and color to serve specific functions and needs. Within a village of workstations, you can tastefully embed meeting zones, relaxation areas, technical zones and storage areas. Plus, everything can be reconfigured at any time!

Focus

# Creative space





# Focus



## Thinking space

28.0 Create a focus zone with yellow USM Privacy Panels. Take a pastel gray laminate USM Haller desk, add a graphite black mobile caddy, and you get the perfect individual workspace – a place to retreat artfully separated from the neighboring workstation.

## Secluded space

29.0 USM Privacy Panels help create compact, protected workspaces – varying in size, shape and color, quickly set up and rearranged. We suggest pearl gray laminated USM Haller Advanced desks and ruby red mobile caddies.

Added value  
Slide open the USM Haller Advanced table surface to conceal your cables and network access equipment.

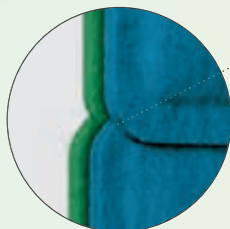

Bicolor  
USM Privacy Panels now offer you more freedom of choice: thanks to the modular production process, the front side of each panel can now be given a different color than the back.

Focus

# Multiple workstations







# Focus

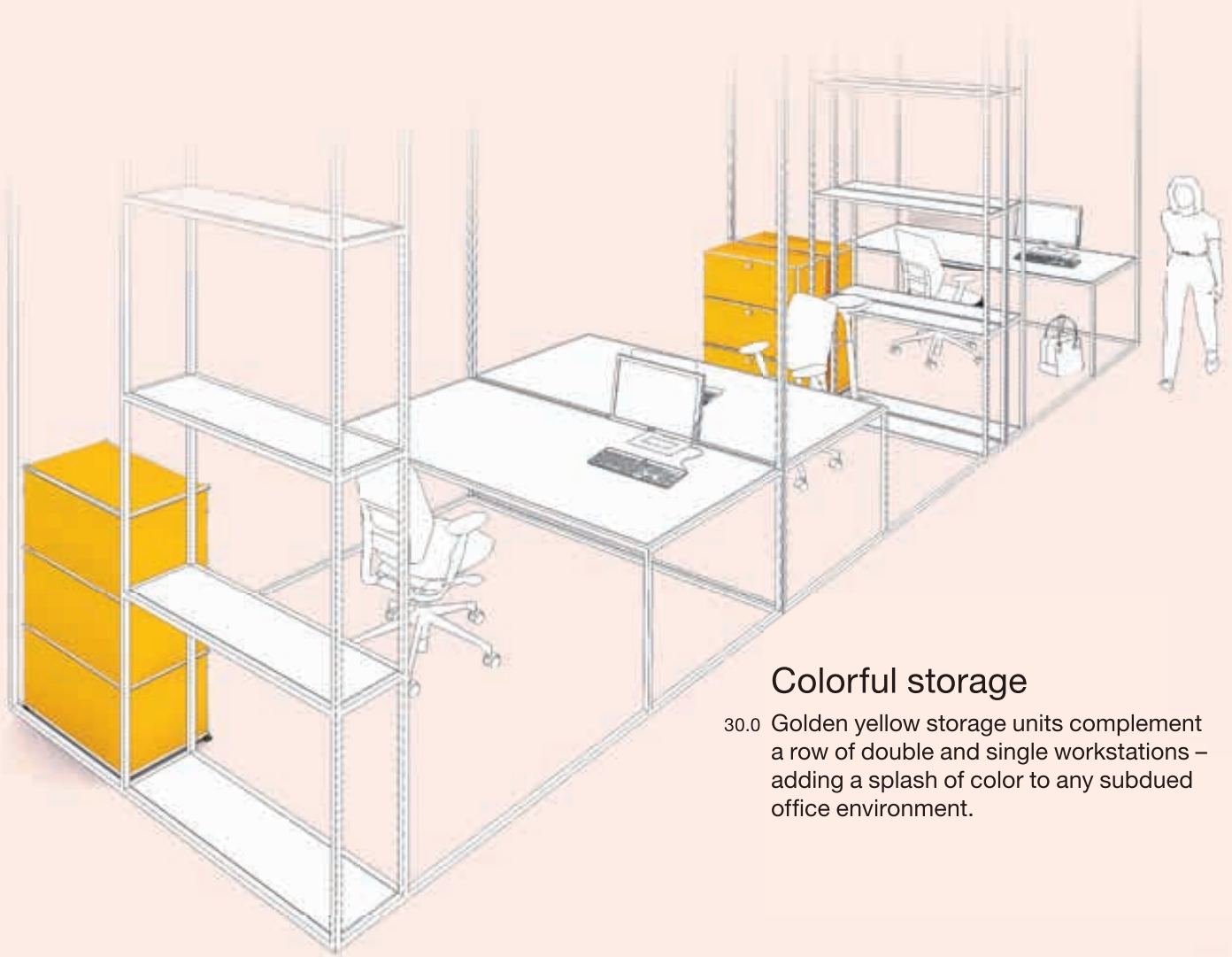

## Colorful storage

30.0 Golden yellow storage units complement a row of double and single workstations – adding a splash of color to any subdued office environment.



Easy organization  
USM Inos box sets  
with five or ten drawers  
facilitate your organiza-  
tion and help you keep  
papers in order.  
Discover the full range  
of functional accesso-  
ries on page 67.

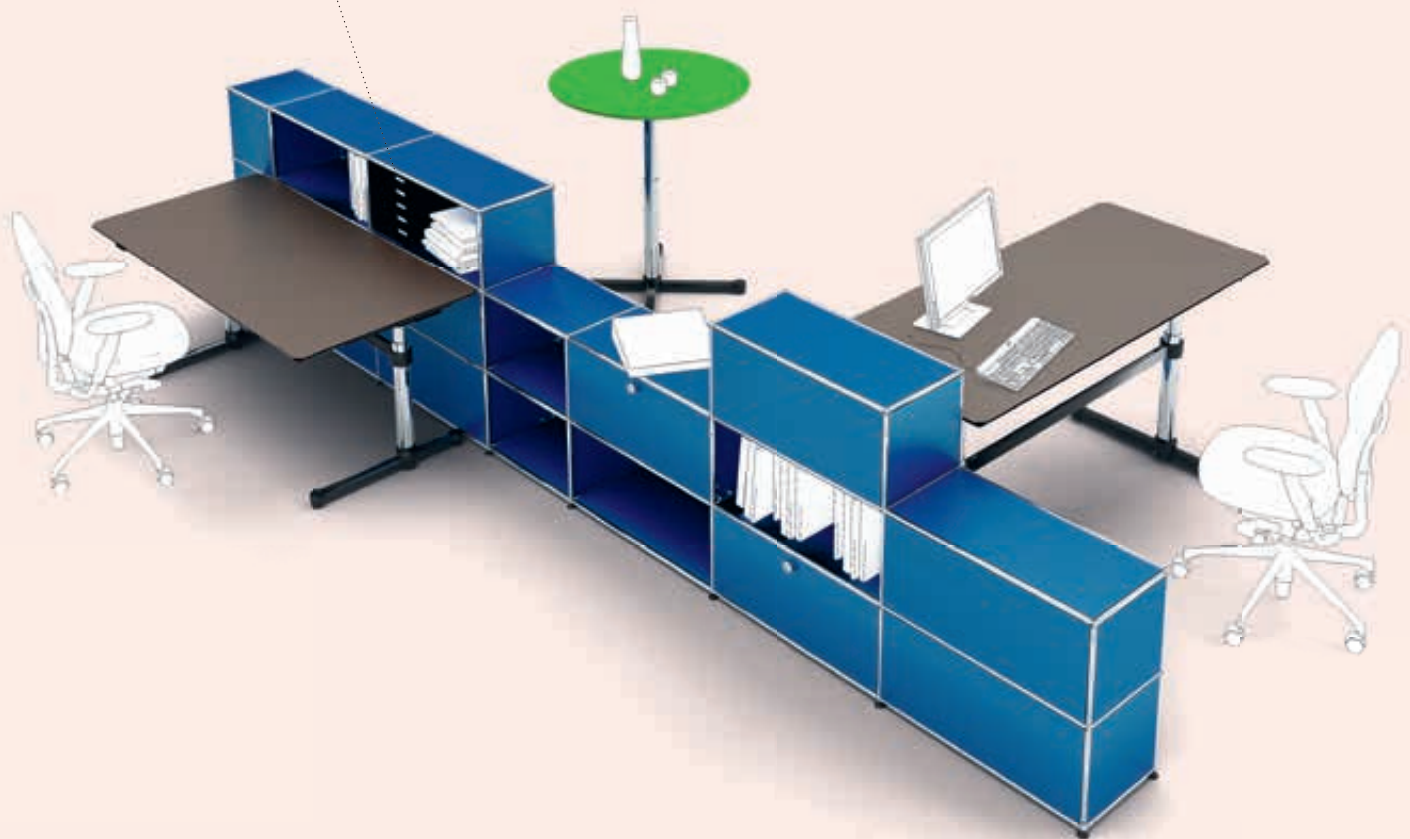

## Functional alignment

31.0 Your timeless office layout with style and class and a pleasant dash of color, thanks to the ruby red USM Haller storage units. Dividing the room in a practical way, they are accessible from both sides, optimizing space and function.

## Strong connection

32.0 The gentian blue USM Haller storage and organizational unit is the connecting element between two single workstations with electric height-adjustable USM Kitos E tables. The clever bit about it: the unit is accessible from both sides, serving both employees perfectly.

Focus

# Individual workstations





# Focus



## Classic beauty

33.0 A classic double workstation of timeless elegance: black oak veneer USM Kitos M Plus desks with graphite black storage units also serve as room dividers. Simple perfection in timeless beauty.

## Team players

34.0 USM Kitos desks in ash linoleum combined with gray Privacy Panels make a modern, flexible office for four colleagues – working individually and in a group whenever necessary. The yellow USM Privacy Panels build a printing station accessible to all team members.



Additional platform  
Not only do drop-down  
doors beautifully hide  
the items behind  
them, they also provide  
easy access – most  
importantly, you can  
use them as a work sur-  
face that holds up to  
10 kilos.

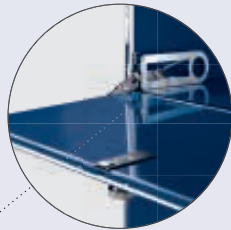

## Breathing space

35.0 A double workstation for a well-attuned duo equipped with all the necessary high-quality furniture: USM Privacy Panels in anthracite serve as room dividers, USM Haller tables with steel-blue back-lacquered glass provide extra-spacious work surfaces and steel-blue shelving offers storage.

Focus







# Focus



## Versatility

The two adaptation points in the tabletop permit easy insertion of up to four accessories, thus making it possible to transform the table to meet individual user requirements.

## Shared storage

36.0 We call it a z-configuration. It connects two individual workstations to a single unit: two white oiled-oak veneer USM Haller Plus desks with adaptation points and a shared USM Haller storage with drawers accessible from both sides.

## Maximum efficiency

37.0 Four colleagues, little room, full concentration: four pearl gray laminate USM Haller desks, divided by two USM Privacy Panels. Four mid-gray USM Haller storage units with extension doors allow access to the full storage volume.



## Space-saving

38.0 Perfection in efficiency: an extremely compact workspace combines USM Kitos M Plus desks in pebble linoleum and small mobile storage units with extra-deep drawers. Three beige storage units complete the setup.



Clean desk  
No unsightly cables:  
the USM Kitos M Plus  
desk is kept clear at all  
times. All cables and  
network access are under  
the tabletop – tidy  
and easily accessible.

Focus

# Executive offices





# Focus



## Keep it simple

39.0 This is what your timelessly elegant manager's office could look like: steel-blue back-lacquered etched-glass USM Haller table with a white pedestal – design icons conveying true leadership.

## Be iconic

40.0 Authoritative, minimal, sophisticated: the black linoleum USM Haller table and the sideboard with glass showcases your most treasured objects.



## Take a seat

- 41.0 This is a manager's office that makes you feel welcome. The USM Haller desk is accompanied by a USM Haller square occasional table, both in anthracite powder-coated MDF. The pure white sideboard blends naturally with its surroundings, while the red return unit makes its presence known.



## Sit to stand

- 42.0 The golden yellow shelf marks a colorful accent in this functional yet stylish office. The USM Kitos E Plus desk and USM Kitos E freestanding table, both in charcoal linoleum, are height-adjustable. Sit or stand while working or having a spontaneous meeting.

Focus

# Ergonomic offices







# Focus



## Comfort zone

43.0 Relax and work in a comfortable office: the natural oiled oak veneer USM Kitos E meeting desk provides a generous work surface. The steel-blue powder-coated MDF coffee table invites you to read or relax.



Height adjustment  
Simply turn the handle  
and the USM Haller  
desks adjust to you –  
from 680 to 860 mm in  
height.



## Personalization

44.0 Adjust your desk to a comfortable height: the USM Haller desk in pebble linoleum is equipped with continuous height adjustment from 680 to 860 mm. Slim anthracite shelving provides maximum flexibility; drawers, doors and smart accessories can be added at any time.



## Sit to stand

45.0 Meet and chat in an informal, spontaneous way while having a cup of coffee, standing around a natural lacquered beech veneer USM Kitos M meeting desk, which is height-adjustable with zero energy consumption. The elegant pure white USM Haller storage units fit perfectly into the space.

Strong core

# values

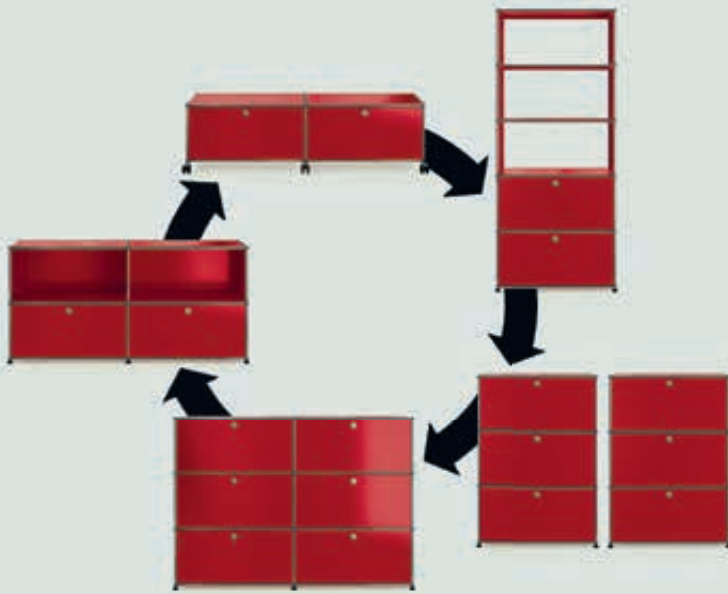

## Form follows you

Unlike many static design classics, celebrating individuality by adapting design and function to its user. For more than 50 years, flexibility, durability and consequently sustainability are core values of the USM brand. USM Modular Furniture is designed to be reconfigured – at any time.

## Sustainable concepts and actions

Developing solutions that respond to changing needs while remaining environmentally conscious has always been a USM philosophy. Since the beginning, and throughout USM's development, handling energy, emissions, materials and production methods in a responsible manner has been a key mission. In this regard, the longevity of USM products is of utmost importance. The longer the product can be used, the less impact it has on the environment. High-quality, durable materials, manufactured with the latest environmentally friendly technologies, guarantees a long, useful life for our product.



## Made in Switzerland

Founded in 1885, USM is a family business now in its fourth generation. «Made in Switzerland» to us is both a promise and an obligation. It stands for precision, quality, dependability, first-rate materials, careful workmanship and total commitment – on behalf of customer interest and out of respect for the environment.



Founded in 1885 and headquartered in Münsingen, Switzerland, USM today is still a family-owned and family-led business, now in its fourth generation.



## Worldwide services

USM provides trained specialists in furniture configuration, delivery and installation to ensure professional customer support. For USM assembly and repair, contact us directly or one of our 400 authorised sales partners in 40 countries, guaranteeing top-quality service around the world. Our modular system embodies dependability, and our customer service guarantees that you will receive quick, personalised answers to your questions. For customized advice, do not hesitate to visit our showrooms. USM has established a prominent reputation and international presence with flagship stores in Bern, Berlin, Düsseldorf, Hamburg, London, Munich, New York, Paris, Stuttgart and Tokyo that showcase local culture and offer technical support.

# USM Haller

The USM Haller system provides a wide variety of elements in standard sizes. Widths, depths and heights are indicated below. All measurements refer to the distance between axes.



Your safety matters to us. Check out the USM safety instructions now. [www.usm.com/safety](http://www.usm.com/safety)

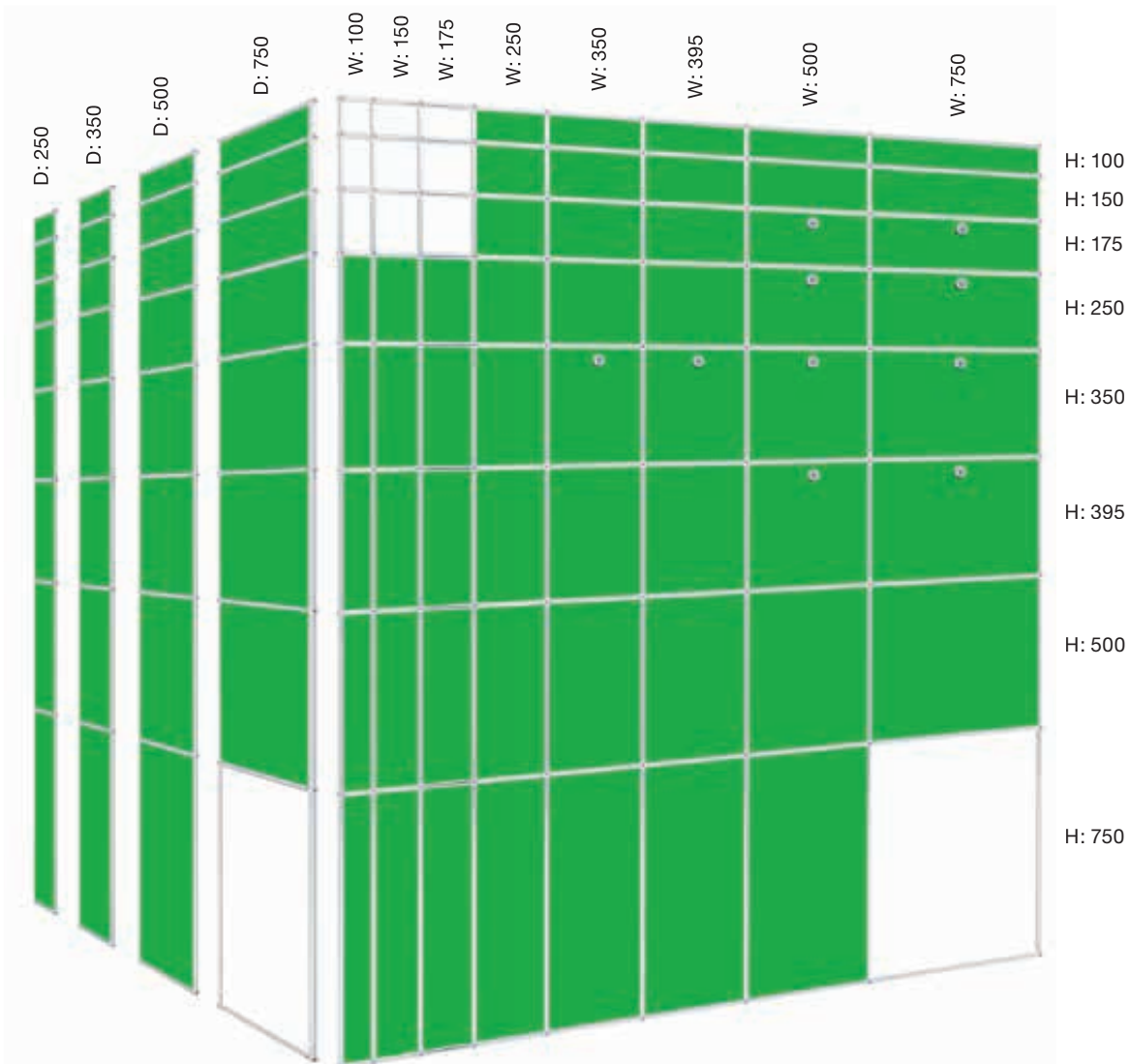
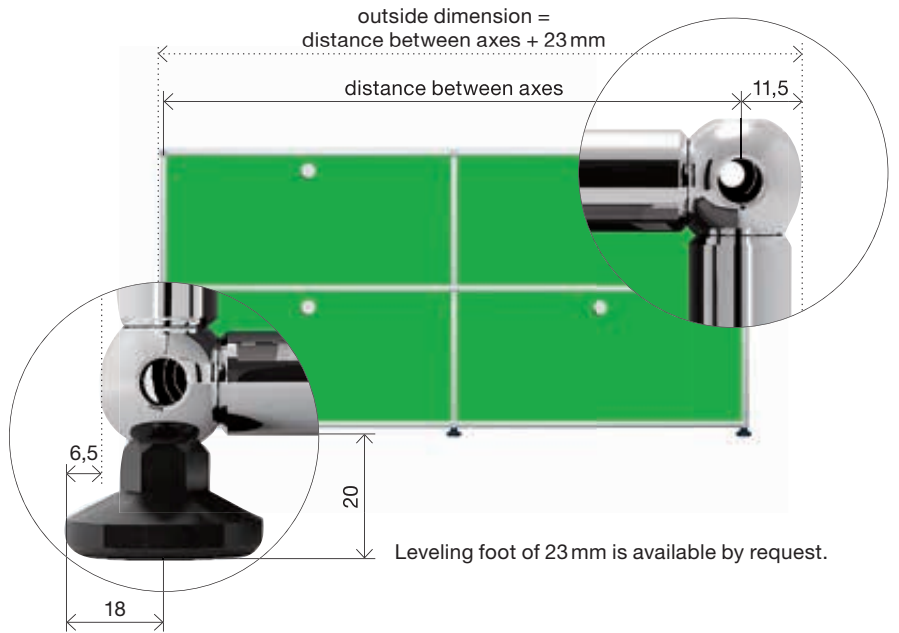

All measurements in mm.

Panels

Doors

Shelves and drawers

Accessories

- 1 Metal panel
- 2 Glass panel
- 3 Acoustic panel
- 4 Perforated metal panel\*

- 5 Metal flip-up door\*
- 6 Glass door
- 7 Acoustic drop-down door\*
- 8 Metal drop-down door
- 9 Metal extension door\*

- 10 Metal divider shelf
- 11 Glass divider shelf
- 12 Metal extension shelf
- 13 Metal angled shelf
- 14 Extension filing set with extension shelf
- 15 Small drawer D: 500
- 16 A6 drawer D: 500
- 17 A5 drawer D: 500
- 18 A4 drawer D: 500
- 19 Extension filing set D: 500

- 20 Hanging file baskets
- 21 Metal box insert
- 21a Slide profile for metal box insert
- 22 Cable cut-out
- 23 Metal, magnetic bookend
- 24 USM Inos Box
- 25 USM Inos DVD tray
- 26 USM Inos CD tray

- 27 USM Inos angled file trays
- 28 USM Inos card box set
- 29 Bookend for bookshelf panel (D: 350)
- 30 USM Inos C4 box set, open
- 31 USM Inos C4 box set, closed
- 32 USM Inos drawer organizer set

Start configuring your individual piece of USM now!  
[www.usm.com](http://www.usm.com)



\*Acoustic version available.  
 USM Inos accessories are available in graphite black and light gray.

Illustration: USM Haller  
 in D: 500 mm.  
 All measurements in mm.

# USM Haller E

## Application Options

A modular structure of your design, either completely or partially equipped with e-Balls and e-Tubes, is connected to a source of electricity. The structure itself conducts the low voltage electricity to the desired location using the e-Balls, e-Connectors and e-Tubes to form a circuit. USB chargers or light sources can be snapped into place in pre-cut recesses. The power supply is drawn from any point near the ground. The power supply cable is attached to a Haller e-Ball, and the power adapter is subsequently tucked underneath the furniture until only the operating switch remains visible. From this point the power supply requires no further cables but rather is integrated into the structure of the furniture.

- 1 **Glass Panel**  
Glass elements can be illuminated throughout.
- 2 **Without Metal Paneling**  
Compartments without metal paneling can be completely illuminated.
- 3 **With Metal Paneling**  
Compartments with metal paneling can be illuminated from the front.
- 4 **Compartment with an Extension Shelf**  
The entire compartment with an extension shelf can be illuminated.
- 5 **Drop-Down and Extension Door**  
Via the "Light When Compartment Is Open" function, the light automatically turns on when the door is opened.
- 6 **Angled Shelf**  
The presentation space is illuminated from the front.
- 7 **Floor Lighting**  
With floor lighting, the light shines at a 25-degree angle under the furniture.
- 8 **Ambient Lighting**  
The light is directed vertically towards the back, illuminating the surroundings with a warm glow.
- 9 **e-USB Charger**  
It can be integrated in the same places as the e-Lights.



Winner of the German Design Award 2019 for outstanding design quality in the Office Furniture category



Winner of the Wallpaper Design Awards 2018



Winner of the Focus Gold Award 2018 for outstanding design quality



Winner of the Muuuz International Award 2018 in the furniture category



Winner of the FX Design Awards, Lighting Product 2017





## e-Elements

### 1 e-Lights

Dimmable, available in  
 – Warm white  
   2700 Kelvin  
 – Cold white  
   5700 Kelvin  
 Both with or without the “light at compartment opening” function.

### 2 e-USB Charger

Provides a voltage of 5 volts to the connected device. (Capacity: 6.5 W)

### 3 e-Dummy

Sleek, black e-Dummy element close recesses that are still unutilised. If a piece of furniture should later be supplemented with additional light, using e-Tubes (consuming), which are first equipped with e-Dummy elements, is recommended.

### 4 e-Tube (power outlet)

Tubes with recesses for e-Lights, e-USB chargers or e-Dummy elements that can be easily snapped into place or replaced.

L 350, 1 recess  
 L 500, 2 recesses  
 L 750, 3 recesses

### 5 e-Tube (conductive)

The conductive e-Tube serves to conduct the electricity if no inserts are desired in this location. It is available in lengths of 750, 500, 395, 350, 250 and 175 mm.

### 6 e-Ball, e-Connector

To enable the flow of electricity, the ball and connector were refined. The exterior dimensions remain unchanged. The distinguishing feature of the ball is the black insulation ring.

### 7 e-Power Supply

Includes dimmer at the operating switch. Transforms the power supply voltage to 24 volts. (Capacity: 60 W)



Engineered & Made in Switzerland.

Only available in certain countries. Please contact USM Switzerland for availability in your country.



# USM Haller Table

The USM Haller classic and USM Haller Plus Desk can be equipped with an optional cable basket, while the USM Haller Advanced features integrated smart solutions for electrification. All desks can be equipped with grommet hatches for network access.

## Basic table

Optional cable basket underneath the tabletop



USM Haller Classic

H: 740  
L: 3000 / D: 1000  
L: 3000 / D: 750  
L: 2500 / D: 1000  
L: 2500 / D: 750  
L: 2250 / D: 1000  
L: 2250 / D: 750  
L: 1000 / D: 1000  
L: 750 / D: 750

H: 740 or 680–860\*  
L: 2000 / D: 1000  
L: 2000 / D: 750  
L: 1750 / D: 1000  
L: 1750 / D: 750  
L: 1500 / D: 1000  
L: 1500 / D: 750  
L: 1250 / D: 750

## Sliding tabletop + adaptation points

Integrated cable tray accessible from above by sliding back the tabletop  
Adaptation points for accessories



USM Haller Advanced

H: 740 or 680–860\*  
L: 2000 / D: 1000  
L: 2000 / D: 750  
L: 1750 / D: 1000  
L: 1750 / D: 750  
L: 1500 / D: 1000  
L: 1500 / D: 750  
L: 1250 / D: 750

## Working desk

Optional cable basket underneath the tabletop  
Removable adaptation points for accessories



USM Haller Plus

H: 740  
L: 3000 / D: 1000  
L: 3000 / D: 750

H: 740 or 680–860\*  
L: 2000 / D: 1000  
L: 2000 / D: 750  
L: 1750 / D: 1000  
L: 1750 / D: 750  
L: 1500 / D: 1000  
L: 1500 / D: 750  
L: 1250 / D: 750

## Occasional table



USM Haller occasional table, square

H: 370  
L: 3000 / D: 1000  
L: 3000 / D: 750  
L: 2500 / D: 1000  
L: 2500 / D: 750  
L: 2250 / D: 1000  
L: 2250 / D: 750  
L: 2000 / D: 1000  
L: 2000 / D: 750  
L: 1750 / D: 1000  
L: 1750 / D: 750  
L: 1500 / D: 1000  
L: 1500 / D: 750  
L: 1250 / D: 750  
L: 1000 / D: 1000  
L: 750 / D: 750

\*Manual height adjustment with a removable handle.  
All measurements in mm.

Accessories  
for all USM Haller Desks

- 1 **Grommet hatch for network access**  
Flush hinged cover set into the tabletop for easy network access, can be positioned at two different locations.
- 2 **Cable management**  
For the Advanced table type, a cable tray integrated under the tabletop offers storage room and attachment options for all cables and technical components.  
For the traditional USM Haller Table and the USM Haller Plus, a cable basket can be attached.
- 3 **CPU holder**  
Computers in various sizes can be mounted using a simple holding device under the table.
- 4 **Link chain**  
Holds and directs cables to the power source. Flexible and adjustable to various lengths.
- 5 **Power strip**  
Can be configured individually for data and power supply according to country-specific requirements. Available with a 4 m cable. Magnetically fixed in the cable tray.
- 6 **Flat screen pivot arm**  
Screens are screwed to the height adjustable pivot arm using a mounting plate (VESA standard). Available for USM Haller classic desk: The pivot arm can be mounted onto the table edges with the universal holder or into the table leg using an assembly tube. Available for USM Haller Plus and Advanced: The bracket can be connected directly to one of the adaptation points.
- Options  
6a **Mounting at different heights**  
is possible for screens weighing up to 12 kg.  
6b **Continuous height adjustment**  
for screens weighing up to 12 kg.

**Cable duct**

The classic USM Haller table can be updated with a black aluminum cable duct section, with lids that fold open on both sides, to integrate power strips (5) and cables. This enables the table depths to be expanded to the EU standard of more than 800 mm. For table heights of 2000, 1750, 1500, 1250, 1000, 900, 750.

Accessories  
for USM Haller Desk Plus/ Advanced

- 7 **Front and side panel**  
A black mesh fabric can be attached to the back or the side under the table frame. Available for the following table lengths: 2000, 1750, 1500, 1250, 1000, 750 and depths: 1000, 750.
- 8 **Material tray**  
Provides room for writing instruments and can be discreetly stowed under the tabletop.
- 9 **USM Privacy Panels**  
Can be attached to the long side to ensure individuality and privacy for people working at tables configured as a block station. H: 350 or 700. Available for the following table lengths: 3000, 2500, 2250, 2000, 1750, 1500, 1250\*  
\*only for Haller tables without Adaptation points
- 10 **Flat screen support bar**  
The bracket is inserted into the adaptation points. Up to two screens (max. 2 x 12 kg) can be attached using a mounting plate (VESA standard). Screens can be mounted at different heights; screens can be adjusted with ball joints.
- Options  
10a **Flat screen support bar fix**  
10b **Flat screen support bar adjustable**  
Move forwards or backwards 2 notches at a time to adjust the viewing distance.
- 11 **USB adapter**  
The adapter is suitable for USB 2.0 and 3.0 ports; it can easily be inserted into the adaptation point. Usable as power supply or for data transfer.
- 12 **Lamp peg**  
An optional lamp peg for easy attachment of traditional table lamps. Electrification is possible through the adaptation point.

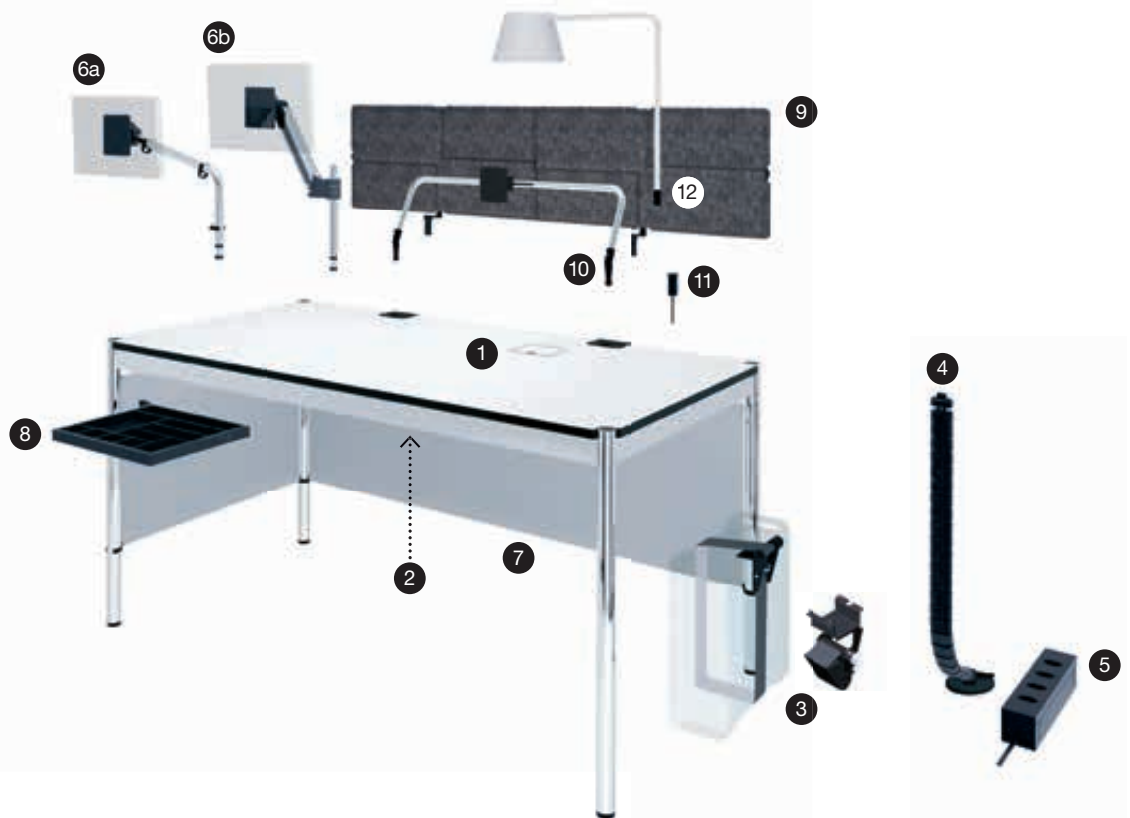

# USM Kitos M and E Desk

Each desk (except free-standing) of the USM Kitos M and E family offers integrated smart solutions for electrification.

## Why USM Kitos M?

The "M" in its name stands for mechanical spring-loaded height adjustment; adjustment time approx. 1 sec. with zero energy consumption. This system is more than 10 times faster than the electronic equivalent and has an extremely long operating life.

## Why USM Kitos E?

Maximum functionality and captivating design – USM Kitos E unites all requirements in one modern workplace: continuous height adjustability and maximum stability. A distinction is made between fixed and motor-driven legs in the E1, E2 and E3 models.

### E1



H: 740  
With or without middle traverse

### E2 with 1 motor



H: 700–1200  
Adjustment time approx. 30 sec.  
With middle traverse

### E3 with 2 motors



H: 650–1300  
Adjustment time approx. 20 sec.  
With middle traverse

## Basic desk

Integrated cable tray underneath the tabletop



### USM Kitos M

H: 700–1200  
L: 1800 / D: 900  
L: 1750 / D: 750  
L: 1600 / D: 800

### USM Kitos E

L: 1800 / D: 900  
L: 1750 / D: 750  
L: 1600 / D: 800  
Available with E1\*, E2 or E3\*\* columns

## Sliding tabletop

Integrated cable tray accessible from above by sliding back the tabletop

Adaptation points for accessories



### USM Kitos M Plus

H: 700–1200  
L: 1800 / D: 900  
L: 1750 / D: 750  
L: 1600 / D: 800

### USM Kitos E Plus

L: 1800 / D: 900  
L: 1750 / D: 750  
L: 1600 / D: 800  
Available with E1\*, E2 or E3 columns

## Extra size

Integrated cable tray underneath the tabletop and accessible from all sides



### USM Kitos M Meeting

H: 700–1150  
L: 2500 / D: 1000  
L: 2250 / D: 1000

### USM Kitos E Meeting

L: 2500 / D: 1250  
L: 2500 / D: 1000  
L: 2250 / D: 1000  
Available with E1, E2 or E3 columns

## Side table



### USM Kitos E Free-standing

H: 740 or 700 – 1110  
Square  
L: 750 and 900  
Round  
Ø: 900 and 1100

\* Available with or without middle traverse.

\*\*Available in a GS-Mark tested version with 3 mm table edge radius and the asymmetrical middle traverse.

The table can also be provided with an asymmetrical version of the middle traverse, for extra legroom. (This is not possible with the USM Kitos E / M Meeting.)

All measurements in mm.

Accessories  
for all USM Kitos M and E Desks

- 1 **Grommet hatch for network access**  
Flush hinged cover set into the tabletop for easy network access, can be positioned at two different locations.
- 2 **CPU holder**  
Computers in various sizes can either be mounted using a simple holding device under the height-adjustable tabletop or attached to the table column.
- 3 **Link chain**  
Holds and directs cables to the power source. Flexible and adjustable to various lengths.
- 4 **Power strip**  
Can be configured individually for data and power supply according to country-specific requirements. Available with a 4 m cable. Magnetically fixed in the cable tray.
- 5 **USM Privacy Panels**  
Can be attached to the long side to ensure individuality and privacy for people working at tables configured as a block station. H: 350 or 700. Available for the following table sizes: 2500, 2250, 1800, 1750, 1600.

Accessories  
for all USM Kitos M and E Desks,  
except USM Kitos M Meeting/  
E Meeting

- 6 **Flat screen pivot arm**  
Screens are screwed to the height adjustable pivot arm using a mounting plate (VESA standard). Available for USM Kitos E/M desk: The pivot arm can be mounted onto the table edges with the universal holder. Available for USM Kitos M and E Plus: The bracket can be connected directly to one of the adaptation points.
- Options
- 6a **Mounting at different heights**  
is possible for screens weighing up to 12 kg.
- 6b **Continuous height adjustment**  
for screens weighing up to 12 kg.
- 7 **Front panel**  
A black mesh fabric attaches to the front under the tabletop. Available for the following table sizes: 1800, 1750, 1600.
- 8 **Material tray**  
Provides room for writing instruments and can be discreetly stowed under the table

Accessories  
for USM Kitos M Plus / E Plus

- 9 **Flat screen support bar**  
The bracket is inserted into the adaptation points. Up to two screens (max. 2 x 12 kg) can be attached using a mounting plate (VESA standard). Screens can be mounted at different heights; screens can be adjusted with ball joints.
- Options
- 9a **Flat screen support bar fix**
- 9b **Flat screen support bar adjustable**  
Move forwards or backwards 2 notches at a time to adjust the viewing distance.
- 10 **USB adapter**  
The adapter is suitable for USB 2.0 and 3.0 ports. It can be inserted easily into the adaptation point. Usable as power supply or for data transfer.
- 11 **Lamp peg**  
An optional lamp peg for easy attachment of traditional table lamps. Electrification is possible through the adaptation point.

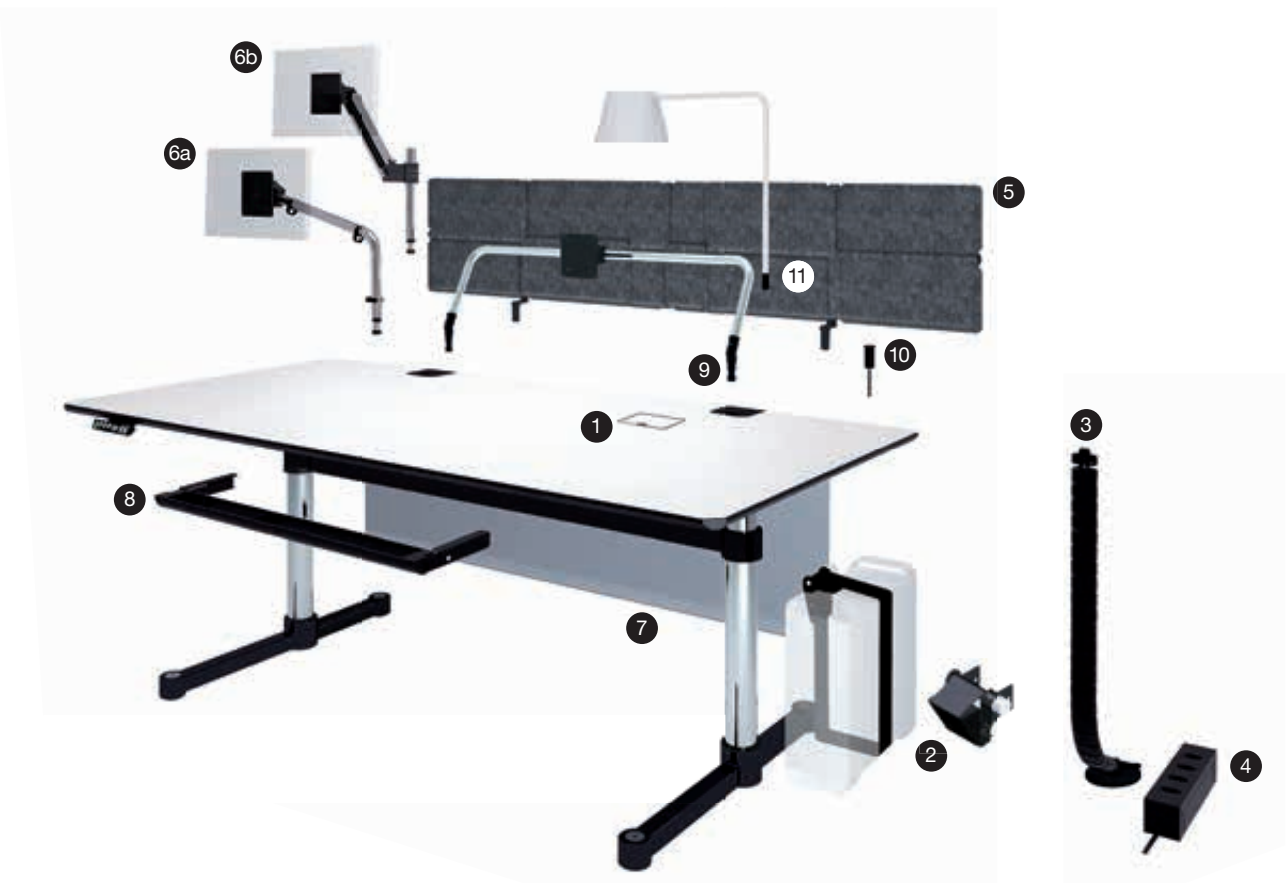

# USM Kitos Desk

Available at a fixed height, with stepwise or free-flow height adjustment, which can be adjusted electronically.

## Rectangular



### USM Kitos Rectangular

H: 740  
L: 1800 / D: 900  
L: 1750 / D: 750  
L: 1500 / D: 750  
L: 900 / D: 750

Stepwise height adjustment  
H: 680–780 / 1060  
L: 1800 / D: 900  
L: 1750 / D: 750  
L: 1500 / D: 750  
L: 900 / D: 750

Continuous height adjustment  
H: 700–1200\*  
L: 1800 / D: 900  
L: 1750 / D: 750  
L: 1500 / D: 750  
L: 900 / D: 750

## Side table



### USM Kitos Free-standing

H: 740  
Square  
L: 900, 750  
Round  
Ø: 1100, 900

Stepwise height adjustment  
H: 680–780 / 1060  
Square  
L: 750  
Round  
Ø: 900  
Rectangular  
L: 900 / D: 750

Continuous height adjustment  
H: 680–1090\*  
Square  
L: 750  
Round  
Ø: 900

\*Not available in glass.  
All measurements in mm.

Accessories  
for all USM Kitos classic desks

- 1 **Universal support**  
Mounts to the table support or directly to the tabletop to hold various accessories.
- 2 **Flat screen pivot arm**  
Screens are screwed to the height-adjustable pivot arm using a mounting plate (VESA standard). This can be mounted onto the tabletop using the universal support (1).
- 3 **Cable duct**  
Black aluminum profile to accommodate power strips (6) and cables. With a hinged cover on both sides.  
Available for the following table lengths: 1800, 1750, 1500, 900
- 4 **USM Privacy Panels**  
Can be attached to the long side to ensure individuality and privacy for people working at tables configured as a block station. H: 350, 700.  
Available for the following table lengths: 1800, 1750, 1500
- 5 **Link chain**  
Holds and directs cables to the power source. Flexible and adjustable to various lengths.
- 6 **Power strip**  
Can be configured individually for data and power supply according to country-specific requirements. Available with a 4 m cable. Is magnetically attached under or over the table or to a piece of furniture or can be integrated into a cable tray.
- 7 **CPU holder**  
Mounts to the table supports. Height-adjustable and rotating. An adjustable strap ensures a secure fit for most standard CPUs.
- 8 **Cable wire basket**  
Mounts to the underside of the work surface.
- 9 **Material tray**  
Mounts and pivots out from under the table surface.



# USM Privacy Panels

USM Privacy Panels are a flexible and extendable modular system made up of individual panel units. Each panel unit consists of two layers of molded polyester fabric with a tubular cross-beam. They can be used in a free-standing version or mounted on tables to divide up the workspace, ensure privacy and absorb unwanted noise.



Winner of the German Design Award 2017



Winner of the Design Preis Schweiz 2015/16





The panels are available in two sizes, a smaller version measuring 250 × 350 mm and a larger version measuring 750 × 350 mm. These dimensions are chosen to match those of USM Haller storage and desks. All measurements refer to the distance between axes.

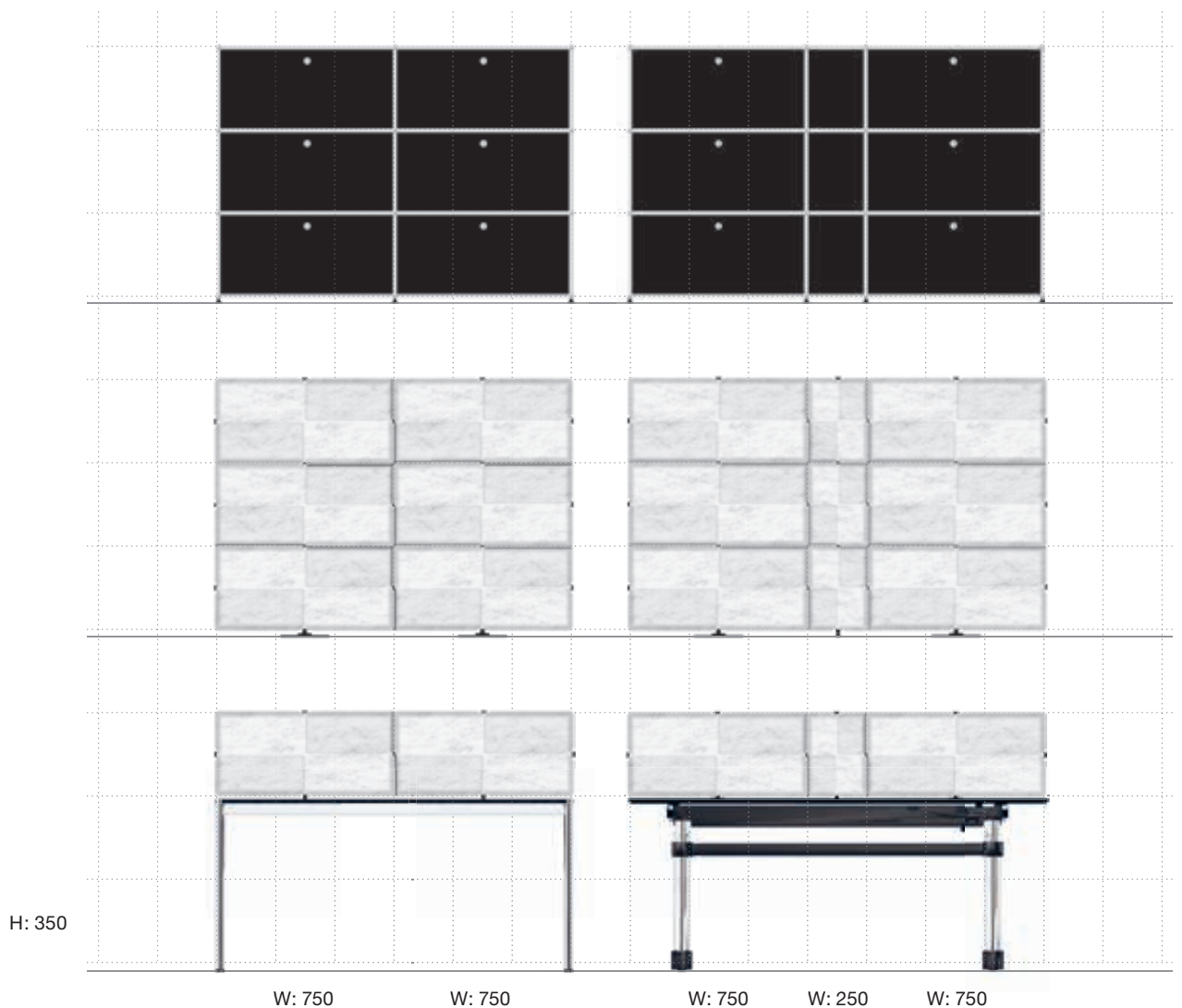
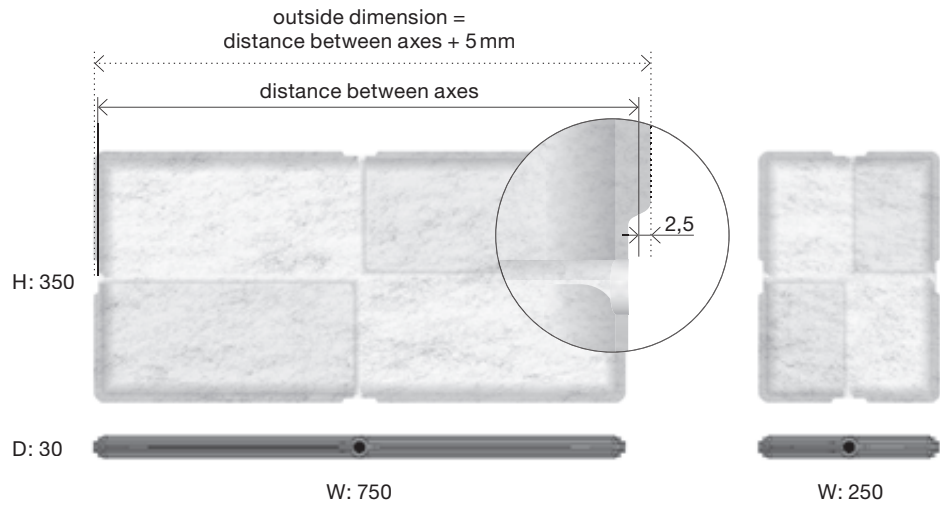

# Colors & surfaces

## USM Haller



### Metal



Pure white  
RAL 9010



Light gray  
RAL 7035



USM matte silver



Mid-gray  
RAL 7005



Anthracite  
RAL 7016



Graphite black  
RAL 9011



Steel blue  
RAL 5011



Gentian blue  
RAL 5010



USM green



Golden yellow  
RAL 1004



Pure orange  
RAL 2004



USM ruby red



USM brown



USM beige

## USM Haller and USM Kitos Tables



### Powder-coated MDF



Pure white  
RAL 9010

### Back-lacquered clear glass



Pure white  
RAL 9010



Light gray  
RAL 7035



USM matte silver



Mid-gray  
RAL 7005



Anthracite  
RAL 7016



Graphite black  
RAL 9011



Steel blue  
RAL 5011



Gentian blue  
RAL 5010



USM green



Golden yellow  
RAL 1004



Pure orange  
RAL 2004



USM ruby red



USM brown



USM beige

### Back-lacquered etched glass



Pure white  
RAL 9010



Light gray  
RAL 7035



Mid-gray  
RAL 7005



Anthracite  
RAL 7016



Graphite black  
RAL 9011



Steel blue  
RAL 5011

### Transparent glass



Transparent glass

Other colors and surfaces available upon request.

Prices and delivery times of table surfaces upon request.

USM Inos accessories are available in graphite black and light gray.

The tabletops in glass are only available for USM Haller Desks up to L: 2000 mm and all USM Kitos Desks with a fixed height (H: 740 mm) or stepwise height adjustment and continuous height adjustment (H: 680–780 / 1060 mm).

# USM Privacy Panels



## Linoleum



Ash linoleum



Charcoal linoleum



Black linoleum



Pebble linoleum



Mauve linoleum

## Laminate

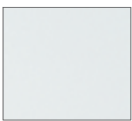

Pearl gray laminate



Pastel gray laminate



Light mid-gray laminate



Dark warm gray laminate

## Oiled or lacquered veneer



White oiled oak veneer



Natural oiled oak veneer



Brown oiled oak veneer



Natural lacquered oak veneer



Natural lacquered beech veneer



Black lacquered oak veneer

## Fabric panel



Light gray



Anthracite



Blue



Green



Yellow

## Switzerland

USM U. Schärer Söhne AG  
Thunstrasse 55, 3110 Münsingen  
Phone +41 31 720 72 72, [info.ch@usm.com](mailto:info.ch@usm.com)

## Germany

USM U. Schärer Söhne GmbH  
Siemensstraße 4a, 77815 Bühl  
Phone +49 7223 80 94 0, [info.de@usm.com](mailto:info.de@usm.com)

## France

USM U. Schärer Fils SA, Showroom  
23, rue de Bourgogne, 75007 Paris  
Phone +33 1 53 59 30 37, [info.fr@usm.com](mailto:info.fr@usm.com)

## United Kingdom

USM U. Schaerer Sons Ltd., London Showroom  
Ground Floor, 49–51 Central St., London, EC1V 8AB  
Phone +44 207 183 3470, [info.uk@usm.com](mailto:info.uk@usm.com)

## USA

USM U. Schaerer Sons Inc., New York Showroom  
28–30 Greene Street, New York, NY 10013  
Phone +1 212 371 1230, [info.us@usm.com](mailto:info.us@usm.com)

## Japan

USM U. Schaerer Sons K.K., Tokyo Showroom  
Marunouchi MY PLAZA 1 · 2F  
2-1-1 Marunouchi, Chiyoda-ku, Tokyo 100-0005  
Phone +81 3 5220 2221, [info.jp@usm.com](mailto:info.jp@usm.com)

All other countries  
contact USM Switzerland.

[www.usm.com](http://www.usm.com)