



# **ES-R-2x01B-M**

## **RS-232 to RS-422/RS-485**

### **Converters Manual**

**Document Reference No.: CP\_000047**

**Version 1.3**

**Issue Date: 01-04-2022**

The Connective Peripheral's ES-R-2001B-M and ES-R-2101B-M is used to convert RS-232 signals to RS-422/RS-485 signals. The converters provide instant connectivity to RS-422/RS-485 communication devices for factory automation equipment, multi-drop data collection devices, barcode readers, time clocks, scales, data entry terminals, PC to PC long distance communications (up to 1.3KM) and serial communication in harsh environments.

This manual covers the following products:

- ES-R-2001B-M
- ES-R-2101B-M

**Connective Peripherals Pte Ltd**  
**178 Paya Lebar Road, #07-03 Singapore 409030**  
**Tel.: +65 67430980 Fax: +65 68416071**

E-Mail (Support): [support@connectiveperipherals.com](mailto:support@connectiveperipherals.com) Web: [www.connectiveperipherals.com/products](http://www.connectiveperipherals.com/products)

Neither the whole nor any part of the information contained in, or the product described in this manual, may be adapted, or reproduced in any material or electronic form without the prior written consent of the copyright holder. This product and its documentation are supplied on an as-is basis and no warranty as to their suitability for any particular purpose is either made or implied. Connective Peripherals Pte Ltd will not accept any claim for damages howsoever arising as a result of use or failure of this product. Your statutory rights are not affected. This product or any variant of it is not intended for use in any medical appliance, device, or system in which the failure of the product might be expected to result in personal injury. This document provides preliminary information that may be subject to change without notice. No freedom to use patents or other intellectual property rights is implied by the publication of this document. Connective Peripherals Pte Ltd, 178 Paya Lebar Road, #07-03 Singapore 409030. Registered Number: 201617872E

## **Table of Contents**

<b>1</b>	<b>Introduction</b>	<b>3</b>
<b>2</b>	<b>Specifications</b>	<b>4</b>
<b>3</b>	<b>Features of the ES-R-2x01B-M</b>	<b>5</b>
3.1	Optical Isolation & Surge Protection (ES-R-2101B-M only)	5
3.2	Power Supply	5
3.3	Enclosure	5
3.4	Configuring for RS-422 and RS-485 Modes	5
<b>4</b>	<b>Hardware Installation</b>	<b>6</b>
4.1	General Notes and Warnings	6
4.2	RS-232 DCE or DTE Pin Assignment	7
4.3	RS-422 and RS-485 Mode Block Configuration	7
4.4	Termination and Biasing Configuration	8
<b>5</b>	<b>Connector Pinout Information</b>	<b>10</b>
5.1	RS-232 Signal Pin-outs of DB-9 Female (DTE Mode)	10
5.2	RS-232 Signal Pin-outs of DB-9 Female (DCE Mode)	10
5.3	RS-422 Signal Pin-out	10
5.4	RS-485 Signal Pin-out (half duplex)	12
5.5	RS-485 Signal Pin-out (full duplex)	14
<b>6</b>	<b>Contact Information</b>	<b>15</b>
<b>Appendix A - List of Figures and Tables</b>		<b>16</b>
List of Figures		16
List of Tables		16
<b>Appendix B - Revision History</b>		<b>17</b>

## 1 Introduction

The Connective Peripheral's ES-R-2001B-M and ES-R-2101B-M is used to convert RS-232 signals to RS-422/RS-485 signals. The converters provide instant connectivity to RS-422/RS-485 communication devices for factory automation equipment, multi-drop data collection devices, barcode readers, time clocks, scales, data entry terminals, PC to PC long distance communications (up to 1.3KM) and serial communication in harsh environments.

The ES-R-2001B-M and ES-R-2101B-M provide an industrial solution for applications requiring single node or multi-drop communications over short or long distances.

In RS-485 half-duplex mode, the ES-R-2001B-M and ES-R-2101B-M also provide automatic data transmit/receive control.

This manual covers the following models:

- RS-232 to RS-422/RS-485 Converter (ES-R-2001B-M)
- Opto-isolated RS-232 to RS-422/RS-485 Converter (ES-R-2101B-M)

## 2 Specifications

### RS-232 to RS-422/RS-485 Converter (ES-R-2001B-M)

- Converts RS-232 port to high-speed RS-422 / RS-485 port
- RS-232 port can be selected to DCE or DTE pin assignment
- Data rate: 300 bps to 1M bps
- RS-232 connector: One DB-9 female connector
- RS-422 / RS-485 connector: One DB-9 male connector and one 5-pin terminal block
- Auto transmit/receive control for 2-wire RS-485 half-duplex operation
- Termination and bias resistors installed on-board and selectable by jumpers
- RS-422 data signals: TX-, TX+, RX+, RX-, GND, RTS-, RTS+, CTS+, CTS-
- RS-485 data signals (full-duplex): TX-, TX+, RX+, RX-, GND
- RS-485 data signals (half-duplex): Data-, Data+, GND
- LEDs indicate TxD and RxD
- Wide input power range: 9V DC to 48V DC
- Operating temperature range: -20°C to 60°C

### Opto-isolated RS-232 to RS-422/RS-485 Converter (ES-R-2101B-M)

- Converts RS-232 port to high-speed RS-422 / RS-485 port
- RS-232 port can be selected to DCE or DTE pin assignment
- RS-422/RS-485 port is optically isolated with 2000 Volt DC optical isolation
- RS-422/RS-485 port is surge protected on all signal lines to withstand electrostatic discharge and power surges up to 25KV ESD
- Data rate: 300 bps to 1M bps
- RS-232 connector: One DB-9 female connector
- RS-422 / RS-485 connector: One DB-9 male connector and one 5-pin terminal block
- Auto transmit/receive control for 2-wire RS-485 half-duplex operation
- Termination and bias resistors installed on-board and selectable by jumpers
- RS-422 data signals: TX-, TX+, RX+, RX-, GND, RTS-, RTS+, CTS+, CTS-
- RS-485 data signals (full-duplex): TX-, TX+, RX+, RX-, GND
- RS-485 data signals (half-duplex): Data-, Data+, GND
- LEDs indicate TxD and RxD
- Wide input power range: 9V DC to 48V DC
- Operating temperature range: -20°C to 60°C

### 3 Features of the ES-R-2x01B-M

#### 3.1 Optical Isolation & Surge Protection (ES-R-2101B-M only)

The ES-R-2101B-M converter is optically isolated with 2000 Volt DC optical isolation. The optical isolation protects the PC from spikes and surges on the RS-422/RS-485 network, by converting the electrical pulse into an optical signal and then changing it back into an electrical pulse. The computer is well protected since the surges and spikes cannot cross the optical link.

The ES-R-2101B-M also features surge protectors, to withstand electrostatic discharge and power surges up to 25KV ESD. The surge suppression on all signals prevents damage caused by lightning or high voltage.

#### 3.2 Power Supply

The ES-R-2001B-M and ES-R-2101B-M accept a wide range of supply voltages, from 9V DC to 48V DC. The power input connector is a 3-pin terminal-block style connector as shown in Figure 1 below.

An external switch-mode power adapter is supplied with the converter.

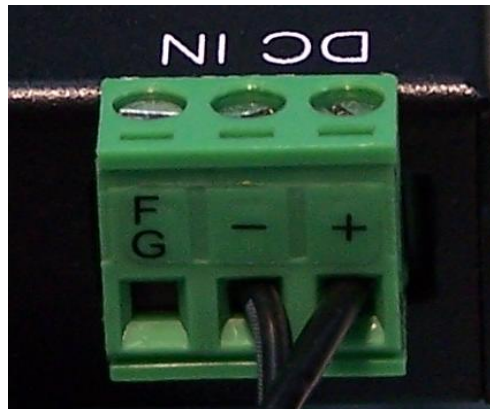

Figure 1 - 9V DC to 48V DC power input connector

#### 3.3 Enclosure

The ES-R-2001B-M and ES-R-2101B-M converters have a metal enclosure. Transmit and Receive LEDs are included to show when data is being transmitted or received on the serial lines. A power LED is also included to show that the converter is receiving power.

#### 3.4 Configuring for RS-422 and RS-485 Modes

The ES-R-2001B-M and ES-R-2101B-M converters use DIP switches to select RS-422 or RS-485 modes. They also feature jumpers to set the pinout of the RS-232 port to a DCE or DTE configuration, and to enable termination and biasing when required.

Please refer to section 4 for more information on the DIP switch and jumper settings available.

## 4 Hardware Installation

### 4.1 General Notes and Warnings

#### Serial Bus Configuration

It is important to configure the DIP switches and jumpers to select the correct type of serial bus (RS-422 or RS-485) for your application before connecting the ES-R-2x01B-M converter to your serial bus. Otherwise, damage can occur to the converter or other equipment on the bus.

To avoid damage, the power supply and serial cables should be disconnected from your converter before changing DIP switch settings and before opening the case to change jumper settings.

#### Termination

For RS-422 or RS-485, it may be necessary to enable termination of the data transmission lines. This depends on the way in which your network is connected and if termination is already provided by other devices on the network. Before applying the termination, check your cable specification for proper impedance matching. The termination option connects a 120 Ohm resistor between the data + and - lines.

Termination is normally used in the node at each end of the bus, but nodes in the middle of the bus should not have termination enabled. Enabling termination resistors on additional nodes which are not at the ends of the bus may cause overloading of the line drivers leading to unreliable operation of the unit and the overall system.

The ES-R-2x01B-M converters have jumpers to allow internal termination resistors to be enabled if required. This avoids the need to provide an external resistor at the ES-R-2x01B-M end of the bus.

Since a computer controlled serial port is normally at one end of the cable, termination is normally enabled. If termination is not required, please disable this feature using the jumpers inside the converter.

ES-R-2x01B-M converters have jumpers for both Tx  $\pm$  termination and Rx  $\pm$  termination. When using RS-485 half-duplex, only the Tx  $\pm$  termination should be enabled.

#### Biasing

For RS-485 half-duplex, it may be necessary to enable biasing of the data transmission lines. In some cases, the RS-485 lines may float to undefined levels when no transmitter is active. This can cause additional unexpected characters to appear at the start or end of a message. Biasing resistors are used to guarantee a defined logic level on the serial lines when no node is transmitting. 750 Ohm resistors pull up the Data + line and pull down the Data - line.

The ES-R-2x01B-M models feature internal 750-ohm resistors with jumpers to enable/disable them. These should be disabled if another device on your serial bus already provides biasing as biasing of data lines must only occur at a single point in the cabling.

The ES-R-2x01B-M converters have four jumpers to select biasing on Tx+, Tx-, Rx+ and Rx-. For biasing of an RS-485 half-duplex bus, enable only the Tx biasing (*Pull-up Tx+ to VCC by 750 Ohm Bias resistor and Pull-down Tx- to GND by 750 Ohm Bias resistor*). The Rx biasing (*Pull-up Rx+ to VCC by 750 Ohm Bias resistor and Pull-down Rx- to GND by 750 Ohm Bias resistor*) should not be enabled.

## 4.2 RS-232 DCE or DTE Pin Assignment

Inside the unit, there are two 2x3 (JP1, JP2) header blocks which are jumpered to select the RS-232 port pin assignment to DCE or DTE. The factory default setting is DCE.

Jumper	Function
JP1 1-3 JP1 2-4 JP2 1-3 JP2 2-4	RS-232 port assigned to DCE (Data Communications Equipment). See Figure 2.
JP1 3-5 JP1 4-6 JP2 3-5 JP2 4-6	RS-232 port assigned to DTE (Data Terminal Equipment). See Figure 2.

**Table 1 - Jumper settings for RS-232 DCE or DTE Pin Assignment**

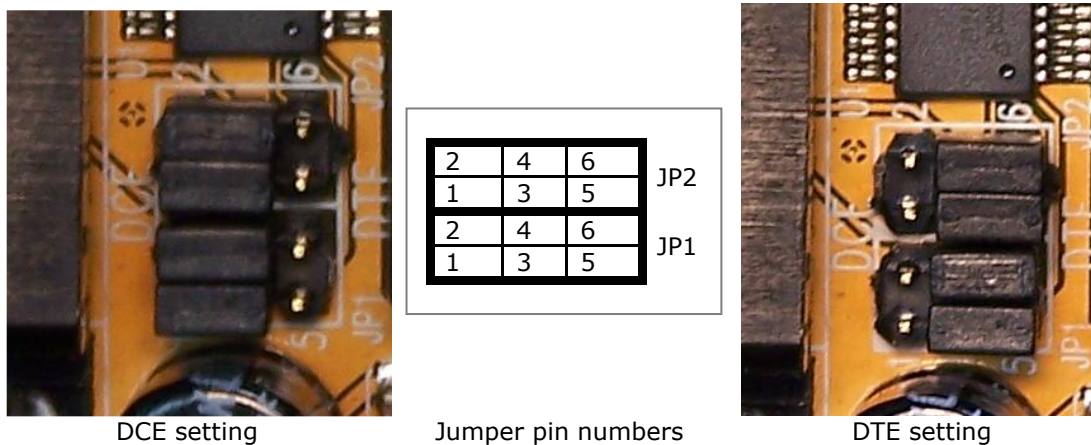

**Figure 2 - Jumpers used to select RS-232 DCE and DTE**

## 4.3 RS-422 and RS-485 Mode Block Configuration

A 3-way DIP switch is used to set to select the mode of operation. The switches should be set to RS-422 mode or RS-485 mode as per the requirements of your application.

The RS-422 & RS-485 Mode Block Configuration Settings are shown in Table 2.

	Operation Mode	S1	S2	S3
RS-422	4 wires with handshaking	ON	ON	ON
RS-485	Full Duplex (4 wire)	OFF	ON	ON
	Half Duplex (2 wire) with Echo	OFF	OFF	ON
	Half Duplex (2 wire) without Echo	OFF	OFF	OFF

**Table 2 - RS-422 and RS-485 configuration**

## 4.4 Termination and Biasing Configuration

Inside the converter, there is a 7x3 (21pin) header block which has jumpers to enable the Tx, Rx and CTS 120 Ohm termination resistors, and the Tx and Rx 750 Ohm biasing resistors. Open the case and set the jumpers as per the requirements of your application. The settings are detailed below.

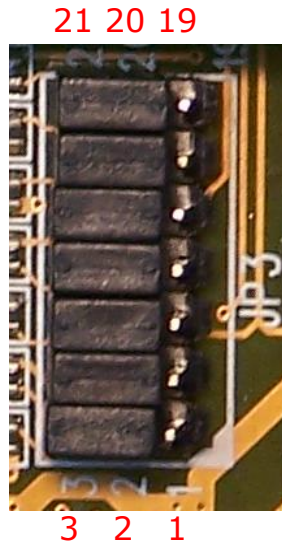

Figure 3 - Setting termination and biasing resistors

Jumper	Function
1-2 enable 2-3 disable	Tx± Termination of 120 Ohm (see notes below table)
4-5 enable 5-6 disable	Tx Bias - Pull-up Tx+ to VCC by 750 Ohm Bias resistor (see notes below table)
7-8 enable 8-9 disable	Tx Bias - Pull-down Tx- to GND by 750 Ohm Bias resistor (see notes below table)
10-11 enable 11-12 disable	Rx± Termination of 120 Ohm (see notes below table)
13-14 enable 14-15 disable	Rx Bias - Pull-up Rx+ to VCC by 750 Ohm Bias resistor (see notes below table)
16-17 enable 17-18 disable	Rx Bias - Pull-down Rx- to GND by 750 Ohm Bias resistor (see notes below table)
19-20 enable 20-21 disable	CTS Termination of 120 Ohm (enable for RS422 mode if termination is required)

Table 3 - Termination and Biasing configuration

### **Note on Termination:**

For RS485 half-duplex, if termination is required, only Tx Termination should be enabled as the Tx and Rx lines are linked. Enable Tx+/- termination (jumper 1-2) and disable Rx+/- termination (jumper 11-12)

For RS485 full-duplex and RS422, termination can be enabled/disabled for Tx+/- and Rx+/- pairs independently using the jumpers as required.

See the notes on Termination in section 4.1 before setting these options

### **Note on Biasing:**

For RS485 half-duplex, if biasing is required, enable Tx+/- biasing only (jumper 4-5 and 7-8) and disable Rx+/- biasing (jumper 14-15 and 17-18)



For RS485 full-duplex and RS422, biasing can be enabled/disabled for Tx+/- and Rx+/- pairs independently as required.

See the notes on Biasing in section 4.1 before setting these options

## 5 Connector Pinout Information

This section shows the connector pinouts used on the ES-R-2001B-M and ES-R-2101B-M converters.

### 5.1 RS-232 Signal Pin-outs of DB-9 Female (DTE Mode)

When configured as a DTE, the signals are assigned as in Table 4. This mode allows a straight-through cable to be used to connect the ES-R-2x01B-M to a DCE device.

Pin Number	Description
1	DCD = Data Carrier Detect
2	RXD = Receive Data
3	TXD = Transmit Data
4	DTR = Data Terminal Ready
5	GND = RS232 signal ground
6	DSR = Data Set Ready
7	RTS = Request to Send
8	CTS = Clear to Send
9	No Connect

**Table 4 - RS-232 Pin-Out for DB-9 connector (DTE)**

### 5.2 RS-232 Signal Pin-outs of DB-9 Female (DCE Mode)

When configured as a DCE, the signals are assigned as in Table 5. This mode allows a straight-through cable to be used to connect the ES-R-2x01B-M to a DTE device.

Pin Number	Description
1	DCD = Data Carrier Detect
2	TXD = Transmit Data
3	RXD = Receive Data
4	DSR = Data Set Ready
5	GND = RS232 signal ground
6	DTR = Data Terminal Ready
7	CTS = Clear to Send
8	RTS = Request to Send
9	No Connect

**Table 5 - RS-232 Pin-Out for DB-9 connector (DCE)**

### 5.3 RS-422 Signal Pin-out

#### DB-9 Male connector

The table below shows the RS-422 pin-out of the DB-9 Male connector.

Pin Number	Description
1	TxD- = Transmit data, negative polarity
2	TxD+ = Transmit data, positive polarity
3	RxD+ = Receive data, positive polarity
4	RxD- = Receive data, negative polarity
5	GND = Signal ground
6	RTS- = Request to send, negative polarity

7	RTS+ = Request to send, positive polarity
8	CTS+ = Clear to send, positive polarity
9	CTS- = Clear to send, negative polarity

**Table 6 - RS-422 Pin-Out for DB-9 connector**

### 5-way Terminal Block

The table below shows the RS-422 pin-out of the 5-way terminal block.

Pin Number	Description
1	TxD- = Transmit data, negative polarity
2	TxD+ = Transmit data, positive polarity
3	RxD+ = Receive data, positive polarity
4	RxD- = Receive data, negative polarity
5	GND = Signal ground

**Table 7 - RS-422 Pin-Out for 5-way terminal block**

### Wiring diagrams

Figure 4 shows an RS-422 full-duplex bus. The ES-R-2x01B-M converters have a built-in resistor for terminating their RxD  $\pm$  input, which can be enabled using a jumper. The Tx  $\pm$  lines which are outputs from the ES-R-2x01B-M are terminated at the receiver at the other end of the bus as shown. Twisted pair wires are required for each signal pair.

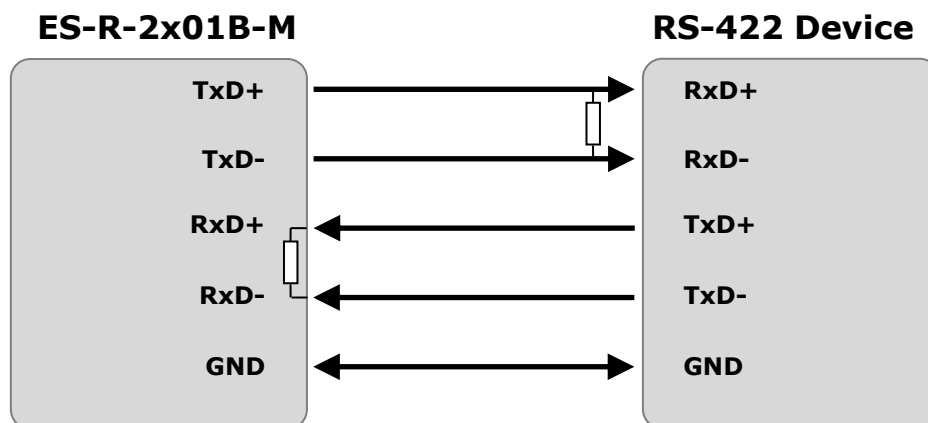

**Figure 4 - RS-422 4 Wire Full Duplex**

Figure 5 shows an RS-422 full-duplex bus with handshaking signals connected. The ES-R-2x01B-M converters have built-in resistors for terminating their RxD ± and CTS ± inputs, which can be enabled using jumpers. The TxD ± and RTS ± lines which are outputs from the ES-R-2x01B-M are terminated at the receiver at the other end of the bus as shown. Twisted pair wires are required for each signal pair.

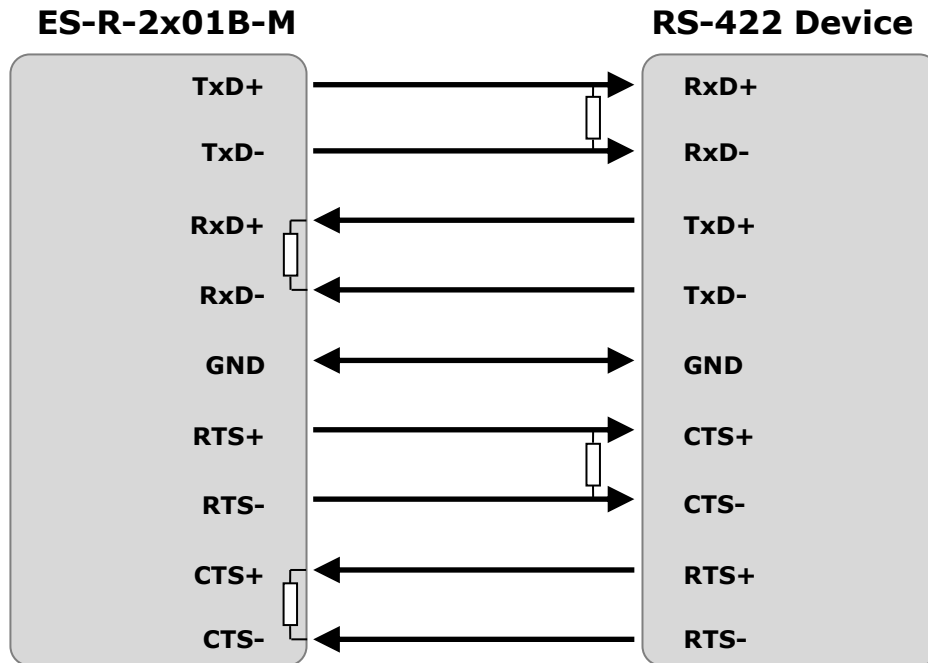

Figure 5 - RS-422 with handshaking signals connected

## 5.4 RS-485 Signal Pin-out (half duplex)

### DB-9 Male connector

Table 8 shows the RS-485 (half duplex) pinout of the DB-9 male connector.

Pin Number	Description
1	Data- = Transmit / Receive Data, negative polarity
2	Data+ = Transmit / Receive Data, positive polarity
5	GND = Signal ground

Table 8 - RS-485 half-duplex pin-out for DB-9 connector

**Note:** Other pins have no function in this mode and should be left unconnected.

### 5-way Terminal Block

Table 9 shows the RS-485 (half duplex) pinout of the 5-way terminal block.

Pin Number	Description
1	Data- = Transmit / Receive Data, negative polarity
2	Data+ = Transmit / Receive Data, positive polarity
5	GND = Signal ground

Table 9 - RS-485 half-duplex pin-out for 5-way terminal bloc

**Note:** Other terminals have no function in this mode and should be left unconnected.

### Wiring Diagrams

The diagram shows an ES-R-2x01B-M converter connected to an RS-485 half-duplex bus. If the ES-R-2x01B-M is at one end of the bus (as shown), the built-in resistor can be enabled to terminate the Data  $\pm$  lines. The Tx  $\pm$  termination jumper is used to enable this resistor. A second termination resistor is fitted at the other end of the bus as shown.

If additional unexpected zero bytes are being received, the ES-R-2x01B-M converters also features bias resistors (not shown below) which can be enabled by enabling the *Pull-up Tx+ to VCC by 750 Ohm Bias resistor* and *Pull-down Tx- to GND by 750 Ohm Bias resistor* jumpers. For further details see sections 4.1 and 4.4. These should not be enabled if another device on the bus is already providing biasing. Twisted pair wires are required for each signal pair.

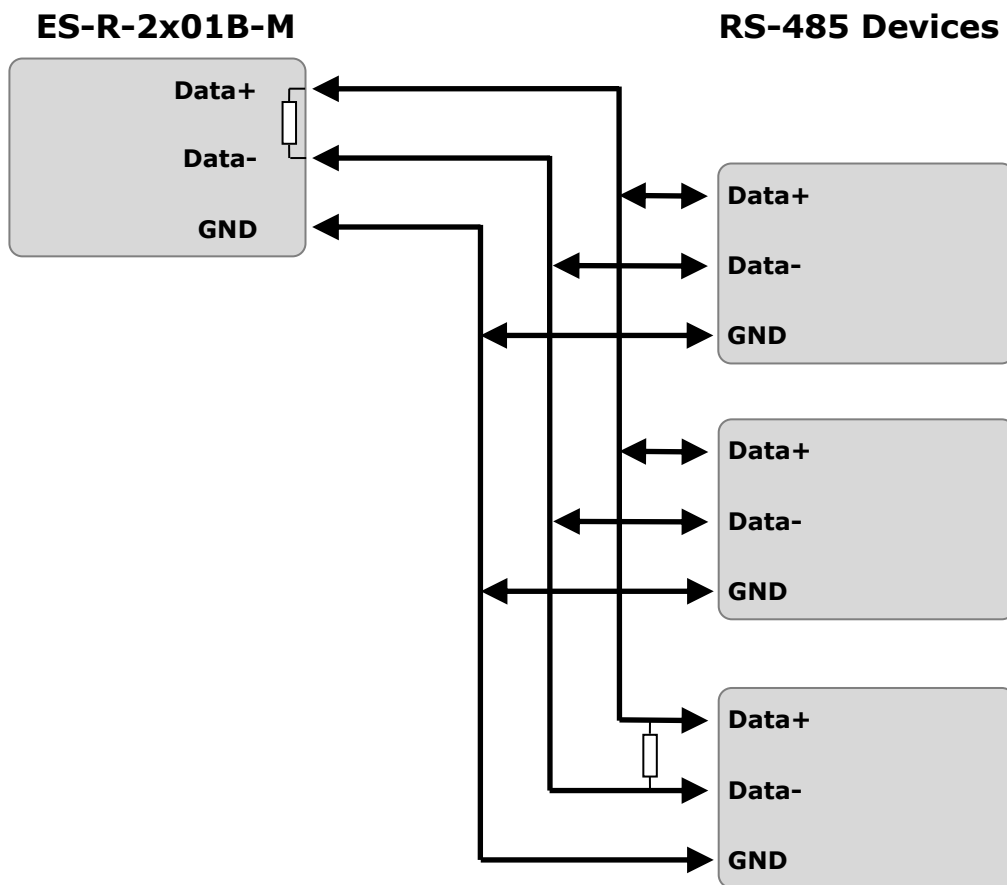

Figure 6 – RS-485 Half Duplex Wiring

## 5.5 RS-485 Signal Pin-out (full duplex)

### DB-9 Male connector

Table 10 shows the RS-485 (full duplex) pinout of the DB-9 male connector.

Pin Number	Description
1	TxD- = Transmit data, negative polarity
2	TxD+ = Transmit data, positive polarity
3	RxD+ = Receive data, positive polarity
4	RxD- = Receive data, negative polarity
5	GND = Signal ground

**Table 10 - RS-485 full duplex pin-out for DB-9 connector**

**Note:** Other pins have no function in this mode and should be left un-connected.

### 5-way Terminal Block

The table below shows the RS-485 (full duplex) pinout of the 5-way terminal block.

Pin Number	Description
1	TxD- = Transmit data, negative polarity
2	TxD+ = Transmit data, positive polarity
3	RxD+ = Receive data, positive polarity
4	RxD- = Receive data, negative polarity
5	GND = Signal ground

**Table 11 - RS-485 full duplex pin-out for terminal block**

### Wiring Diagrams

Figure 7 shows an RS-485 full-duplex bus. The ES-R-2x01B-M has a built-in resistor for terminating its RxD  $\pm$  input, which can be enabled using a jumper. The Tx  $\pm$  lines which are outputs from the ES-R-2x01B-M would be terminated at the receiver at the other end of the bus as shown. Twisted pair wires are required for each signal pair.

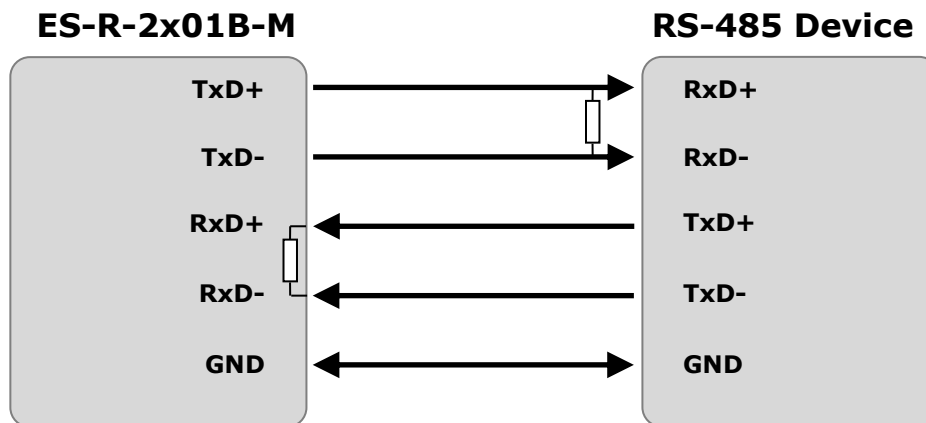

**Figure 7 - RS-485 Full Duplex Wiring**

## 6 Contact Information

### Global Headquarters – Singapore

Connective Peripherals Pte Ltd  
178 Paya Lebar Road  
#07-03  
Singapore 409030

Tel: +65 67430980  
Fax: +65 68416071

E-Mail (Sales)	<a href="mailto:sales@connectiveperipherals.com">sales@connectiveperipherals.com</a>
E-Mail (Support)	<a href="mailto:support@connectiveperipherals.com">support@connectiveperipherals.com</a>
Web Site URL	<a href="http://www.connectiveperipherals.com">http://www.connectiveperipherals.com</a>
Web Shop URL	<a href="http://www.connectiveperipherals.com">http://www.connectiveperipherals.com</a>

## Appendix A - List of Figures and Tables

### List of Figures

Figure 1 - 9V DC to 48V DC power input connector .....	5
Figure 2 - Jumpers used to select RS-232 DCE and DTE .....	7
Figure 3 - Setting termination and biasing resistors .....	8
Figure 4 - RS-422 4 Wire Full Duplex .....	11
Figure 5 - RS-422 with handshaking signals connected.....	12
Figure 6 - RS-485 Half Duplex Wiring .....	13
Figure 7 - RS-485 Full Duplex Wiring .....	14

### List of Tables

Table 1 - Jumper settings for RS-232 DCE or DTE Pin Assignment .....	7
Table 2 - RS-422 and RS-485 configuration .....	7
Table 3 - Termination and Biasing configuration .....	8
Table 4 - RS-232 Pin-Out for DB-9 connector (DTE).....	10
Table 5 - RS-232 Pin-Out for DB-9 connector (DCE).....	10
Table 6 - RS-422 Pin-Out for DB-9 connector .....	11
Table 7 - RS-422 Pin-Out for 5-way terminal block .....	11
Table 8 - RS-485 half-duplex pin-out for DB-9 connector.....	12
Table 9 - RS-485 half-duplex pin-out for 5-way terminal bloc.....	12
Table 10 - RS-485 full duplex pin-out for DB-9 connector .....	14
Table 11 - RS-485 full duplex pin-out for terminal block .....	14



## Appendix B - Revision History

Revision	Changes	Date
1.0	Initial release	24-08-2011
1.1	Added temperature specification to section 2 Updated DTE and DCE definitions in sections 5.1 and 5.2	25-01-2012
1.2	Re-branding to reflect the migration of the product to Connective Peripherals name – logo change, copyright changed, contact information Changed, all internal hyperlinks changed.	25-03-2019
1.3	Additional termination/biasing information and formatting updates	01-04-2022